

Thank you

a promise to support your longevity.

It's our privilege to call you our customer. We realize you have many choices when it comes to selecting a trusted provider of MR technology, and we sincerely appreciate you choosing us.

As part of our commitment to the SIGNA™ Continuum™, we're proud to announce the SIGNA Explorer Lift program for eligible systems with a GE LCC magnet.¹ It's really simple. You can reset the life of your scanner without the hassle of investing in a new system by building upon your magnet's strong foundation to grow beyond your current standard of care. All at half the cost of what it would take to replace your entire system.²



30%

More procedures³

Build

upon your existing magnet's strong foundation

Why trade in when you can trade up? Your magnet is as strong today as it was when it was initially installed. SIGNA Explorer Lift provides new clinical applications and latest generation hardware technology to build upon your magnet's foundation. The result is functionality that shortens exam times, improves signal-to-noise and reduces the need for repeat scans.

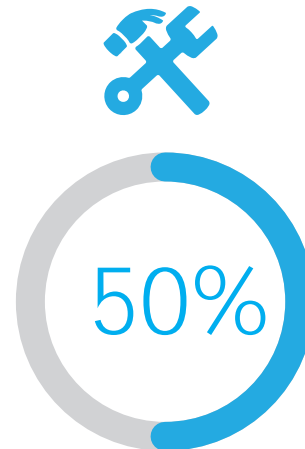

50%

Savings in construction costs²

Reset

the life of your MR

Save time and money by extending the life of your system. There is no reconfiguration and no need to knock down walls. And best of all, your magnet stays in place. We build the SIGNA Explorer from the inside out by replacing all of the electronics, gradients and the workstation.

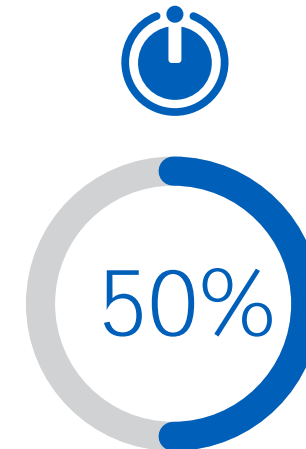

50%

Today's technology at half the cost²

Grow

beyond your standard of care

The SIGNA Explorer Lift program offers the most cost-effective and fastest way to obtain new MR system capabilities. Reset the life of your existing scanner and unlock state-of-the-art MR imaging and productivity benefits while surpassing your referring physicians' expectations.

¹ Exclusions and other terms and conditions may apply. Offer may not be obtainable in all regions. Please contact your local GE representative with any questions about this upgrade program, including if it is available in your region.

² Compared to a new GE 1.5T MR system - upfront cost includes equipment, construction required for the equipment install and potential mobile cost during downtime. Actual costs will vary depending on your site's specific circumstances.

³ With the SIGNA Explorer Lift, the system may be able to scan 2-3 more patients per day due to new capabilities and productivity.



Stick

with your magnet.

Staying current with the latest in MR technology is not always as easy as replacing the old with the new. Maybe you simply can't afford to shut down your operations for an extended period of time during the replacement process. Or maybe replacing the system would require major reconstruction costs.

That's why we developed an economical and expeditious solution as part of the GE MR Continuum. It is a smart solution that uses the same proven, high-quality magnet you already own. The process is simple. The SIGNA Explorer Lift program works within your existing space by building a new system around your current magnet. Once complete, you will have the latest in MR technology and applications.

SIGNA Explorer Lift installation process

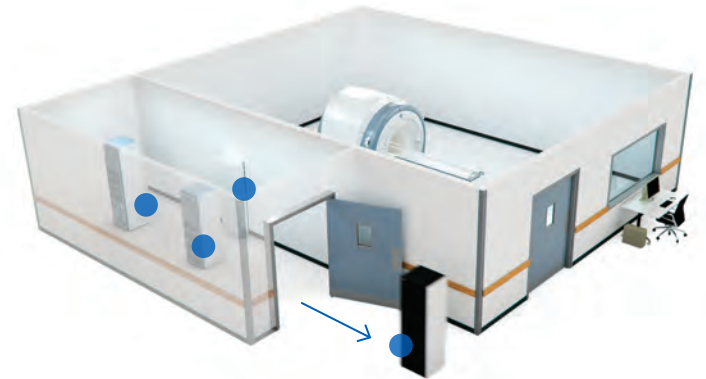

Step one | Remove existing chiller and cabinets.

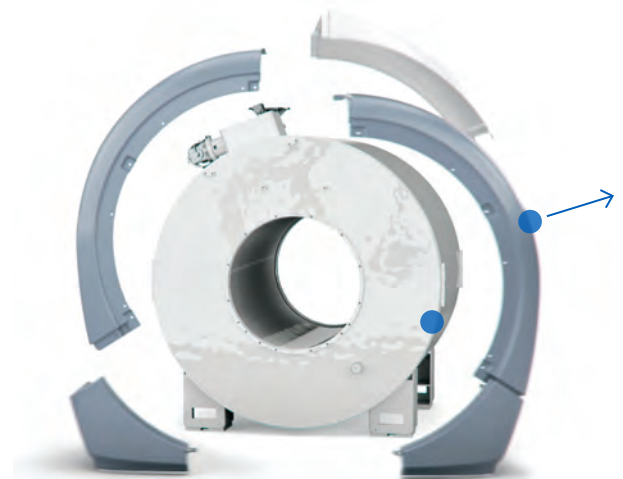

Step five | Remove existing covers.
Keep your existing magnet.

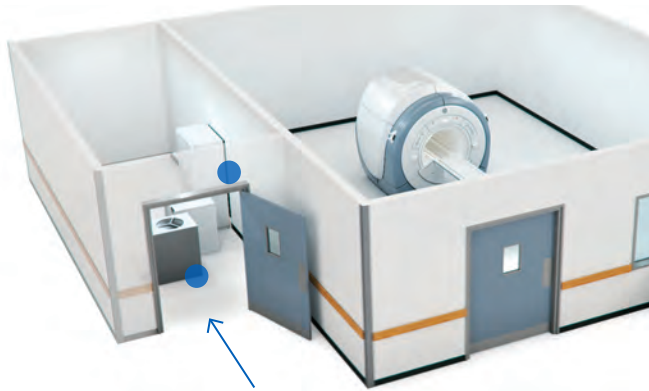

Step two | Update penetration panel.
Install SIGNA Explorer system electronics and space saving cabinets.

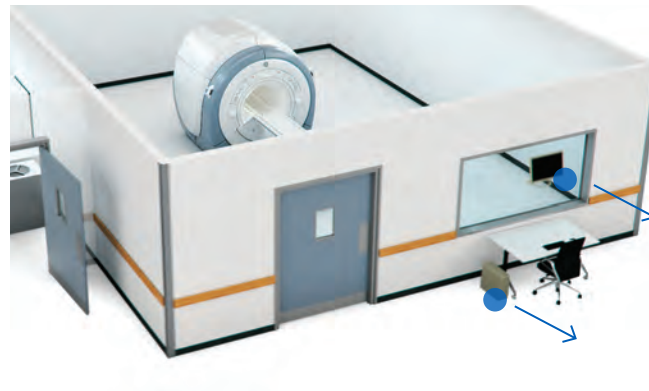

Step three | Remove old operator console.



Step four | Install SIGNA Explorer operator console upgraded with advanced applications.



Step six | Install GE Optix electronics with OpTix RF technology for up to a 27 percent gain in SNR over conventional analog signal receivers.

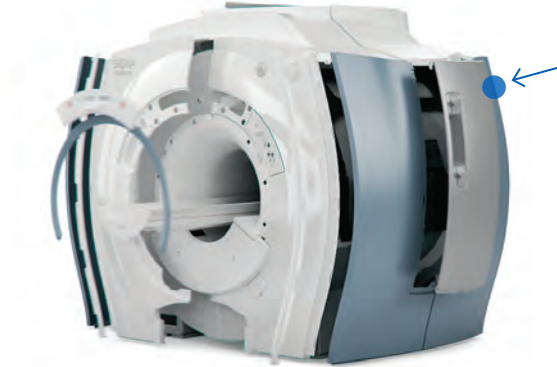

Step seven | Install new SIGNA Explorer covers.



Step eight | Access to the latest generation RF coils and new docking or fixed patient tables.

Light

the way for the future.

With SIGNA Explorer Lift you can attain new heights in image quality. Optix RF can provide a gain in SNR of up to 27 percent over conventional analog receivers. And advanced applications can speed up workflow making the experience more comfortable for patients.

SilentScan

Reduces noise like never before for neuro imaging.

eDWI, IDEAL and Body Navigators

Gives you an extended range of body imaging.

MAVRIC SL

Advances visualization of soft tissues and bone near MR Conditional devices.

3D PROMO

Provides 3D volumetric imaging correction of motion in real-time through a remarkable algorithm that reduces the need for retakes during neuro exams.

Inhance

Visualizes arterial and venous flow with an advanced array of powerful and robust pulse sequences without contrast injection.

FOCUS

Increases resolution in Single Shot DW EPI sequences using a highly efficient method.

3D ASL

Delivers quantitative perfusion assessment without radiation or the need for an IV line.

Brain

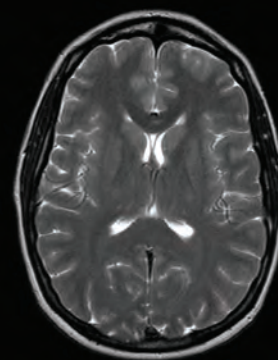

Before

SIGNA LX
Axial T2 FSE
FOV 21 cm, 512 x 224, 5.0 mm/2 | 3:49 min

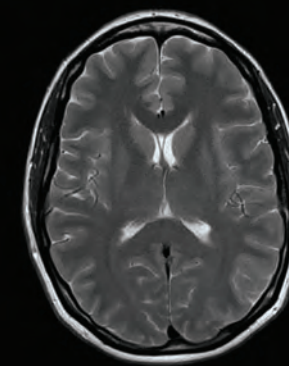

After

Time savings: 65% | Resolution: +13%

SIGNA Explorer Lift
Axial T2 PROPELLER
FOV 24 cm, 416 x 416, 5.0 mm/0.5 | 1:20 min - same patient

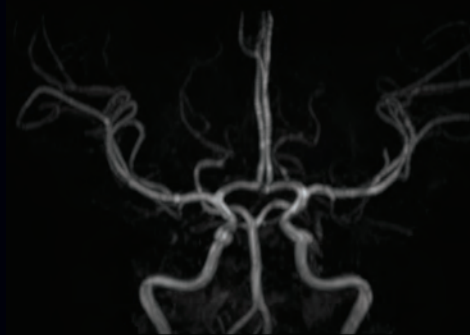

Before

SIGNA Excite
3D TOF
FOV 22 cm, 320 x 224, 1.6 mm | 7:43 min

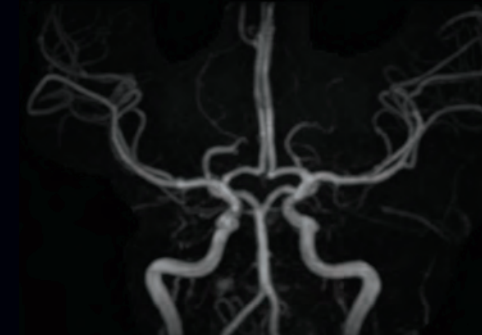

After

Time savings: 53% | Resolution: +12%

SIGNA Explorer Lift
3D TOF
FOV 22 cm, 320 x 192, 1.2 mm | 3:37 min - same patient

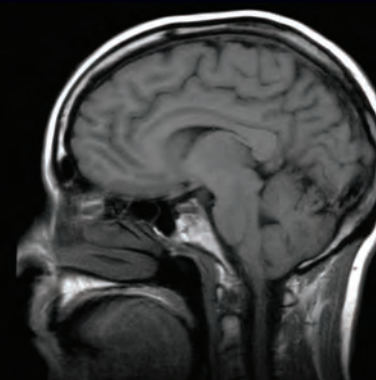

Before

SIGNA LX
Sagittal T1 FLAIR
FOV 24 cm, 256 x 256, 5.0 mm | 3:05 min

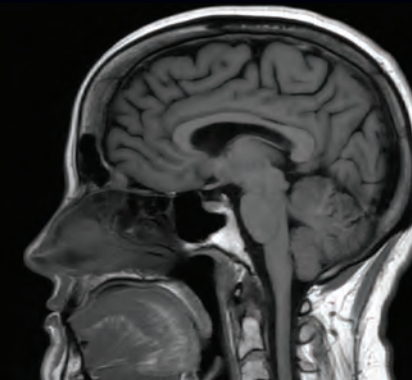

After

Time savings: 20% | Resolution: +20%

SIGNA Explorer Lift
Sagittal T1 FLAIR
FOV 24 cm, 320 x 256, 5.0 mm | 2:28 min

Spine



Before

SIGNA LX
Sagittal T2
FOV 28 cm, 384 x 256, 4.0 mm | 3:06 min



After

Time savings: 25% | Resolution: +11%

SIGNA Explorer Lift
Sagittal T2
FOV 28 cm, 384 x 288, 3.5 mm | 2:20 min - same patient

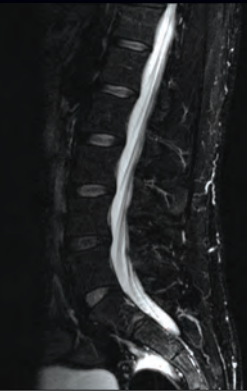

Before

SIGNA LX
Sagittal T2 Fat Sat
FOV 28 cm, 384 x 256, 4.0 mm | 3:06 min



After

Time savings: 24%

SIGNA Explorer Lift
Sagittal T2 Fat Sat
FOV 28 cm, 384 x 256, 3.5 mm | 2:21 min - same patient

Knee

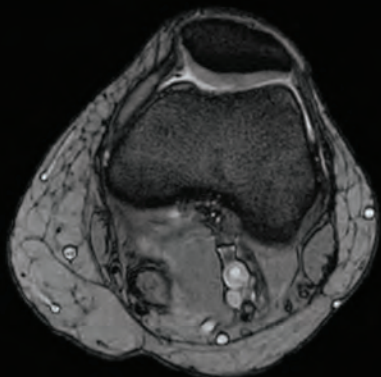

Before

SIGNA LX
Axial T2* GRE
FOV 16 cm, 256 x 224, 4.0 mm | 5:18 min

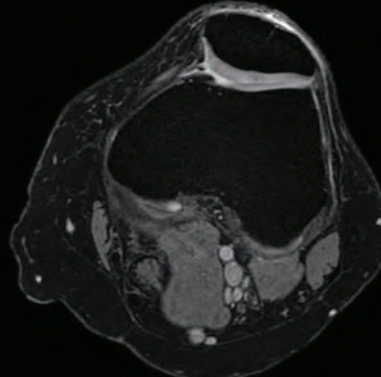

After

Time savings: 43%

SIGNA Explorer Lift
Axial 3D MERGE
FOV 16 cm, 256 x 224, 2.0 mm | 3:01 min - same patient

Shoulder

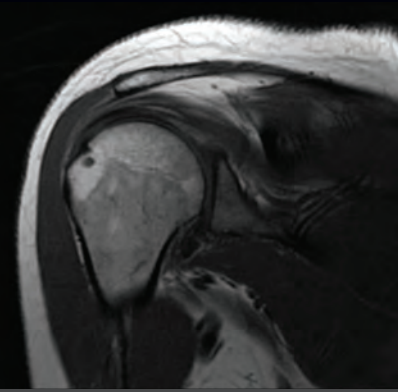

Before

SIGNA LX
Coronal T1
FOV 14 cm, 256 x 192, 4.0 mm | 3:20 min

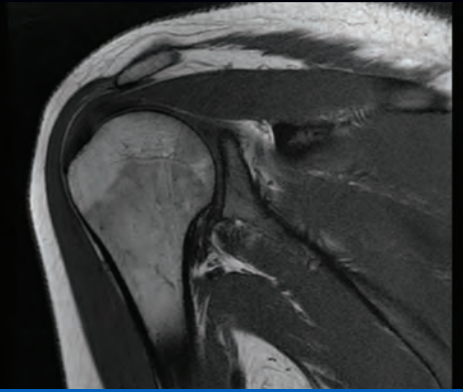

After

Time savings: 50% | Resolution: +40%

SIGNA Explorer Lift
Coronal T1
FOV 14 cm, 320 x 224, 3.5 mm | 1:39 min - same patient

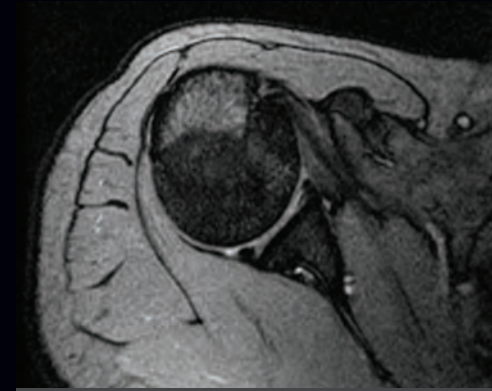

Before

SIGNA LX
Axial GRE T2*
FOV 14 cm, 256 x 192, 3.5 mm | 3:54 min

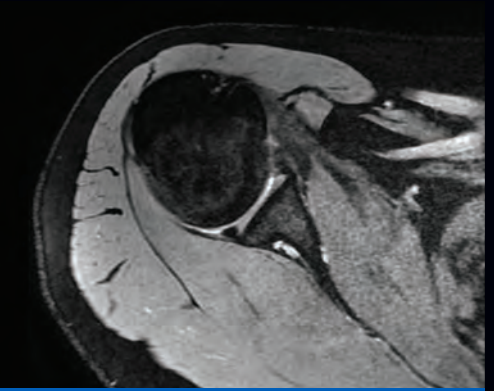

After

Time savings: 20% | Resolution: +40%

SIGNA Explorer Lift
Axial 3D MERGE
FOV 14 cm, 288 x 192, 2.4 mm | 3:08 min - same patient

Wrist



Before

SIGNA Excite
Coronal T1
FOV 10 cm, 384 x 192, 3.0 mm | 4:56 min

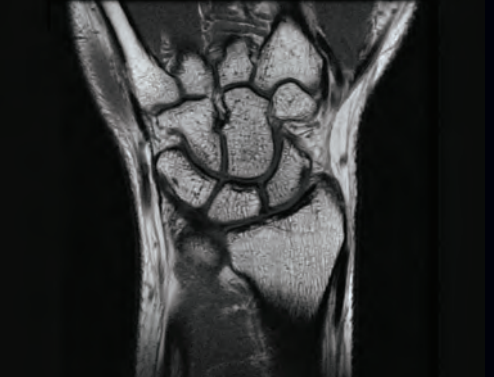

After

Time savings: 68% | Resolution: +59%

SIGNA Explorer Lift
Coronal T1
FOV 10 cm, 416 x 288, 2.0 mm | 1:35 min

SIGNA
Explorer

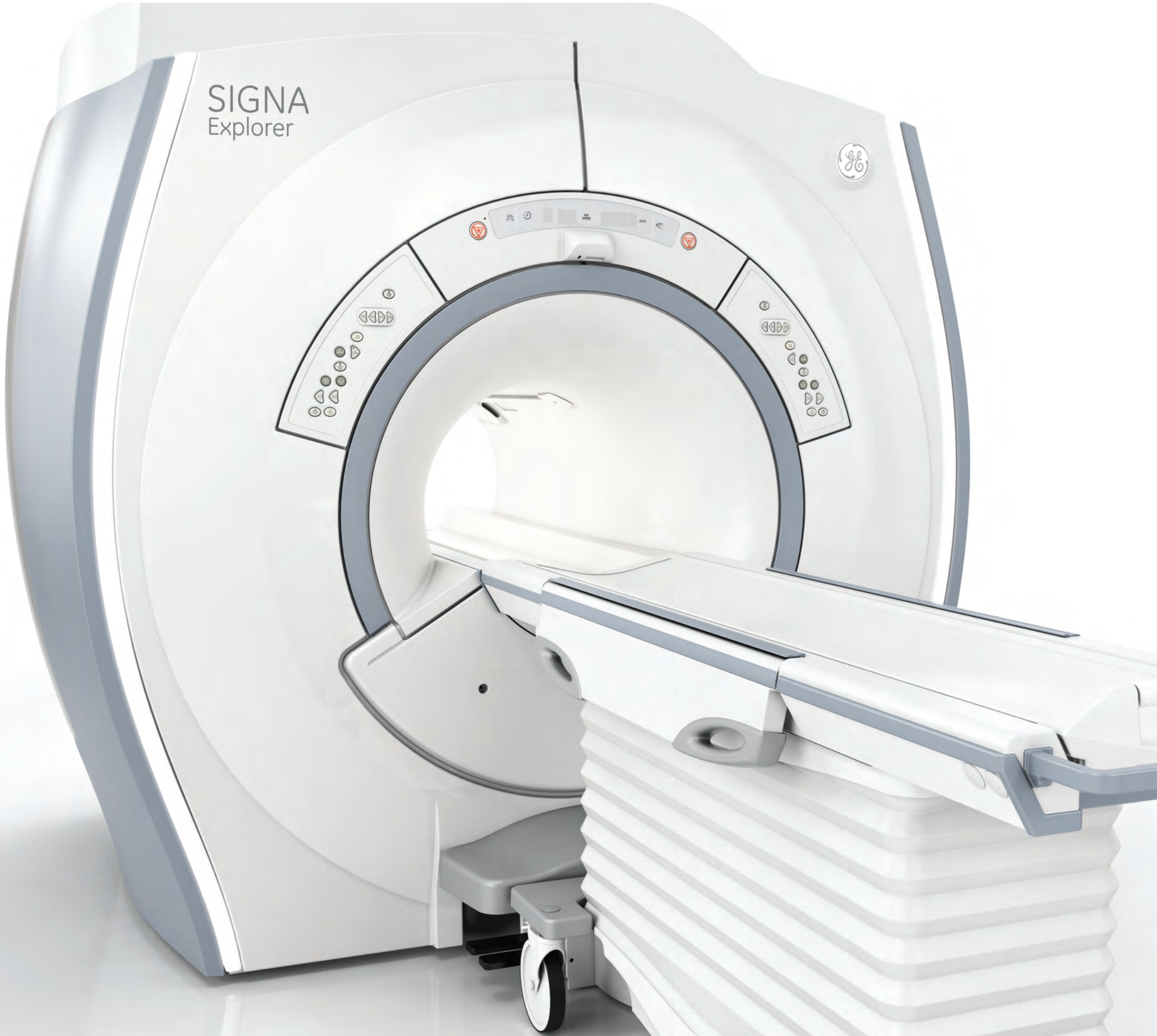

Rediscover

the power of MR.

The core of your MR is already a SIGNA. The SIGNA Explorer Lift program builds off of the strength of your magnet to deliver you a system worthy of all that the SIGNA legacy stands for.

For the past 30 years the name SIGNA has represented innovation, proven quality and trust amongst leaders in the industry. The same holds true today with the SIGNA Explorer delivering exceptional image quality, enhanced patient comfort and improved workflow. With access to advanced applications, intuitive plug-n-play tools, 3D imaging and free-breathing, motion-controlled acquisitions, you can ascend to the next generation of MR.



Stick with your magnet

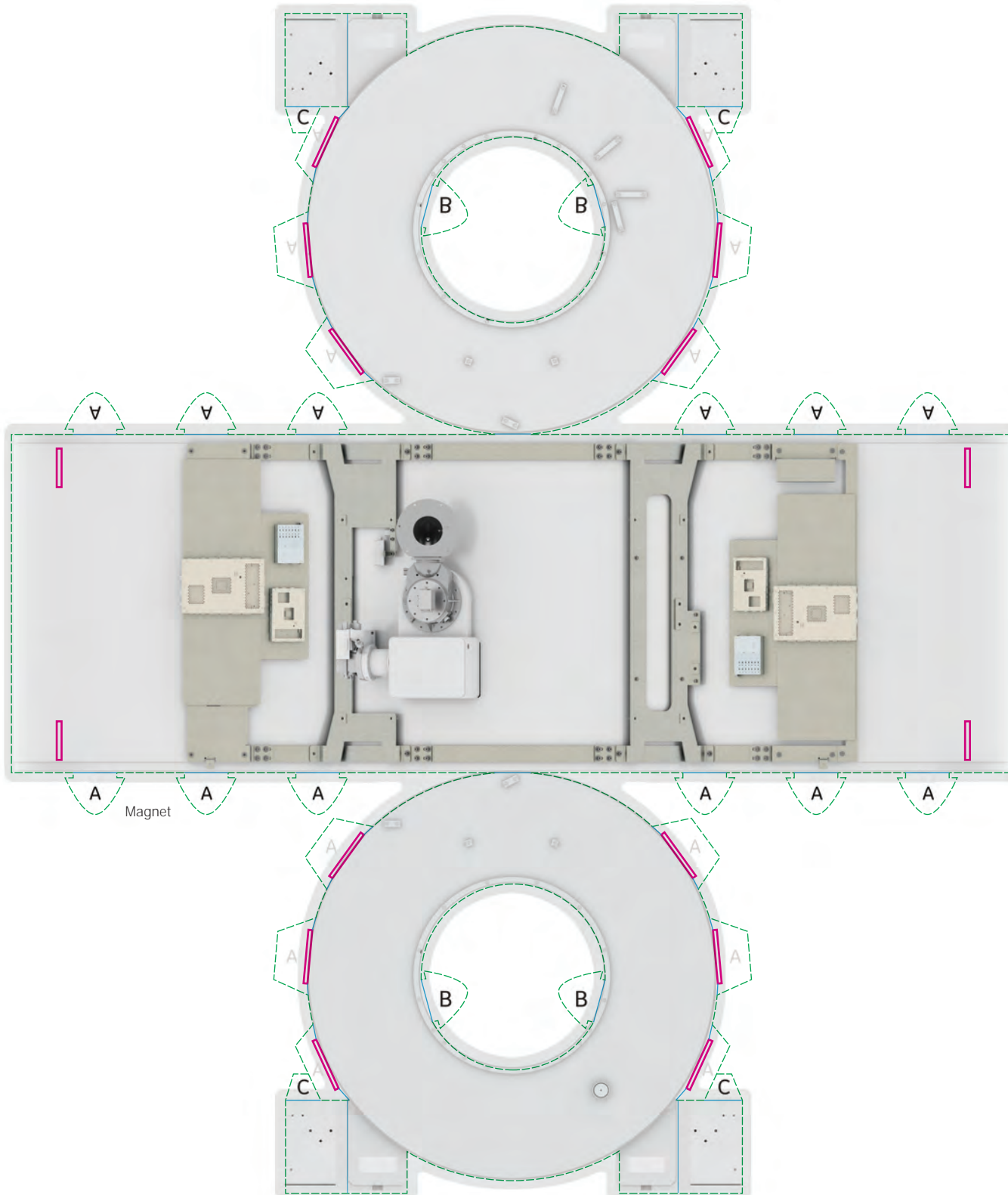

Build

your own SIGNA Explorer Lift model.

Magnet assembly

Curve sides of the magnet into a cylinder and insert A tabs into A slots along one end of the magnet leaving the other side unattached.

Assemble the bore following the bore assembly instructions.

Place assembled bore into the magnet and insert B tabs into B slots on the assembled end of the magnet as shown in Figure 3.

Close the other end of the magnet by first inserting B tabs on the magnet's face plate into B slots on the magnet bore assembly. Then insert A tabs into A slots around the edges of the magnet's face plate.

Insert C tabs located on each magnet foot into corresponding slots on the sides of the magnet as shown in Figure 1.

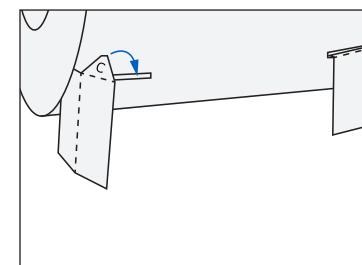
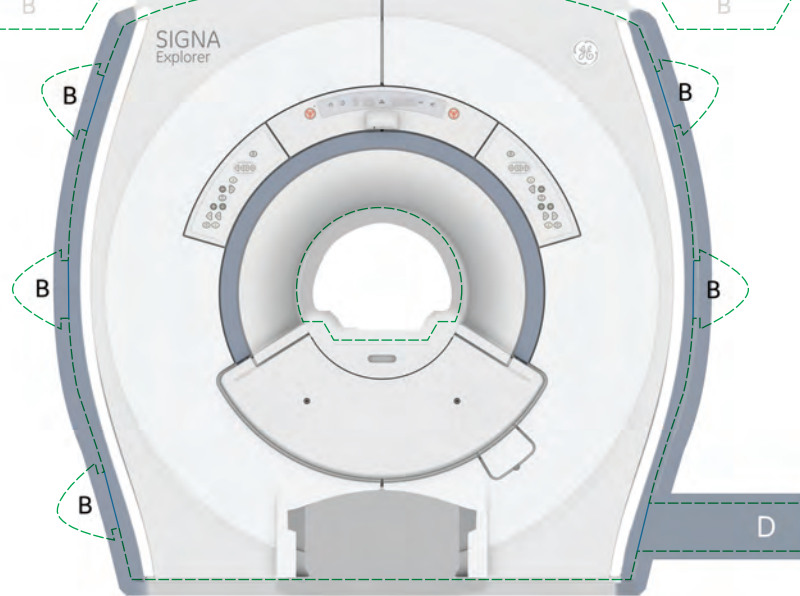
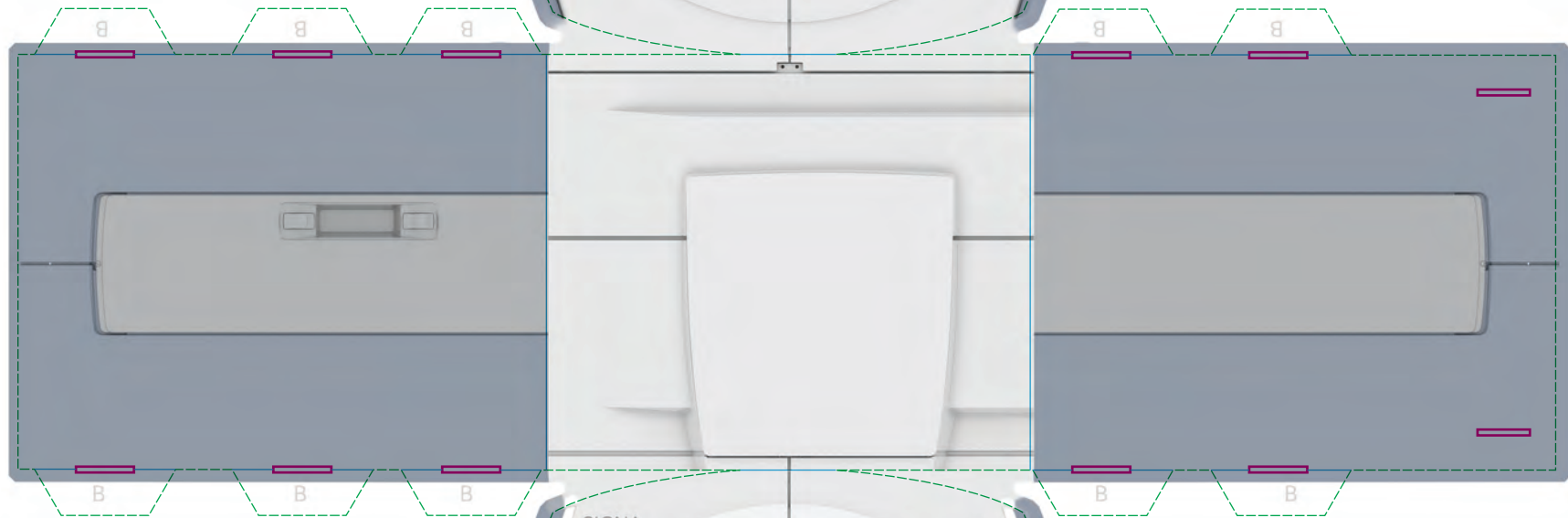
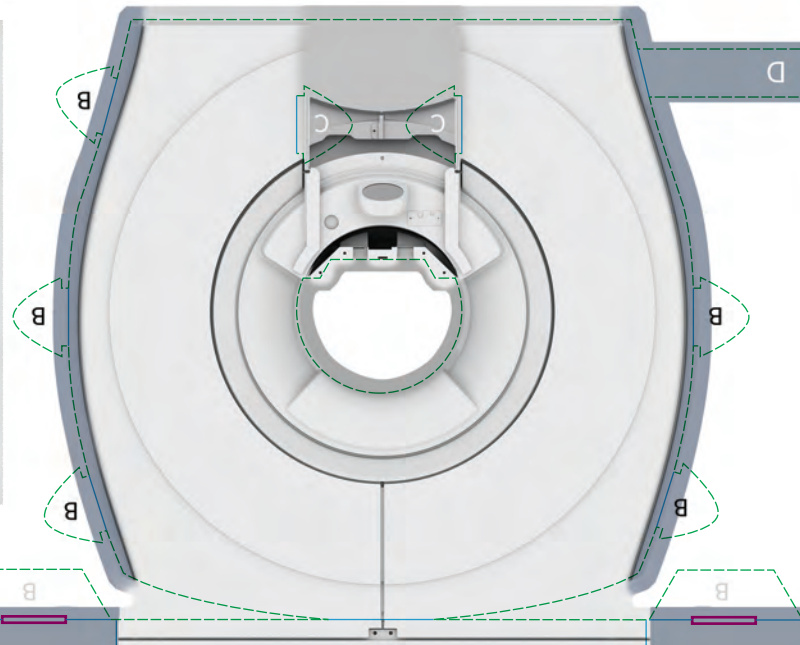
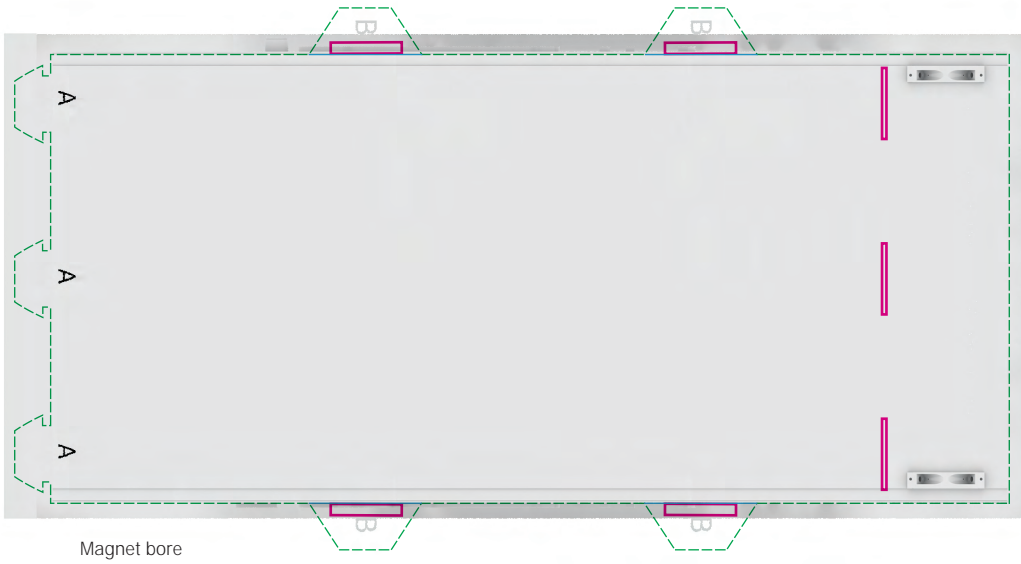

Figure 1

All new SIGNA Explorer covers



Magnet bore assembly

Fold B tabs towards the unprinted side.

Roll into cylinder with the printed graphic showing on the inside.

Insert A tabs into the corresponding slots to hold the bore together as shown in Figure 2.

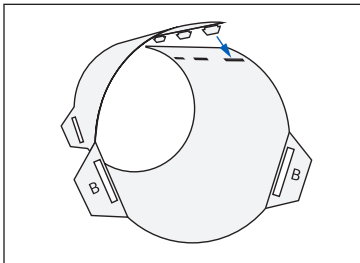

Figure 2

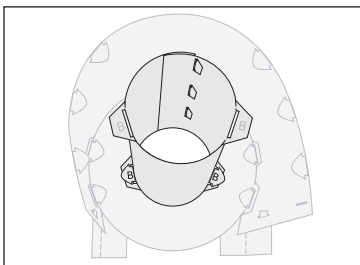

Figure 3

SIGNA Explorer Lift covers assembly

Fold and insert B tabs into B slots.

Fold C tabs outward as shown in Figure 4.

Slide the new SIGNA Explorer covers over your magnet.

Close the side by inserting D tabs into the slots on the side of the cover as shown in Figure 4.

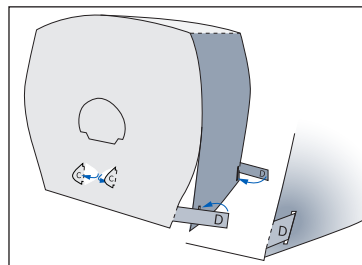
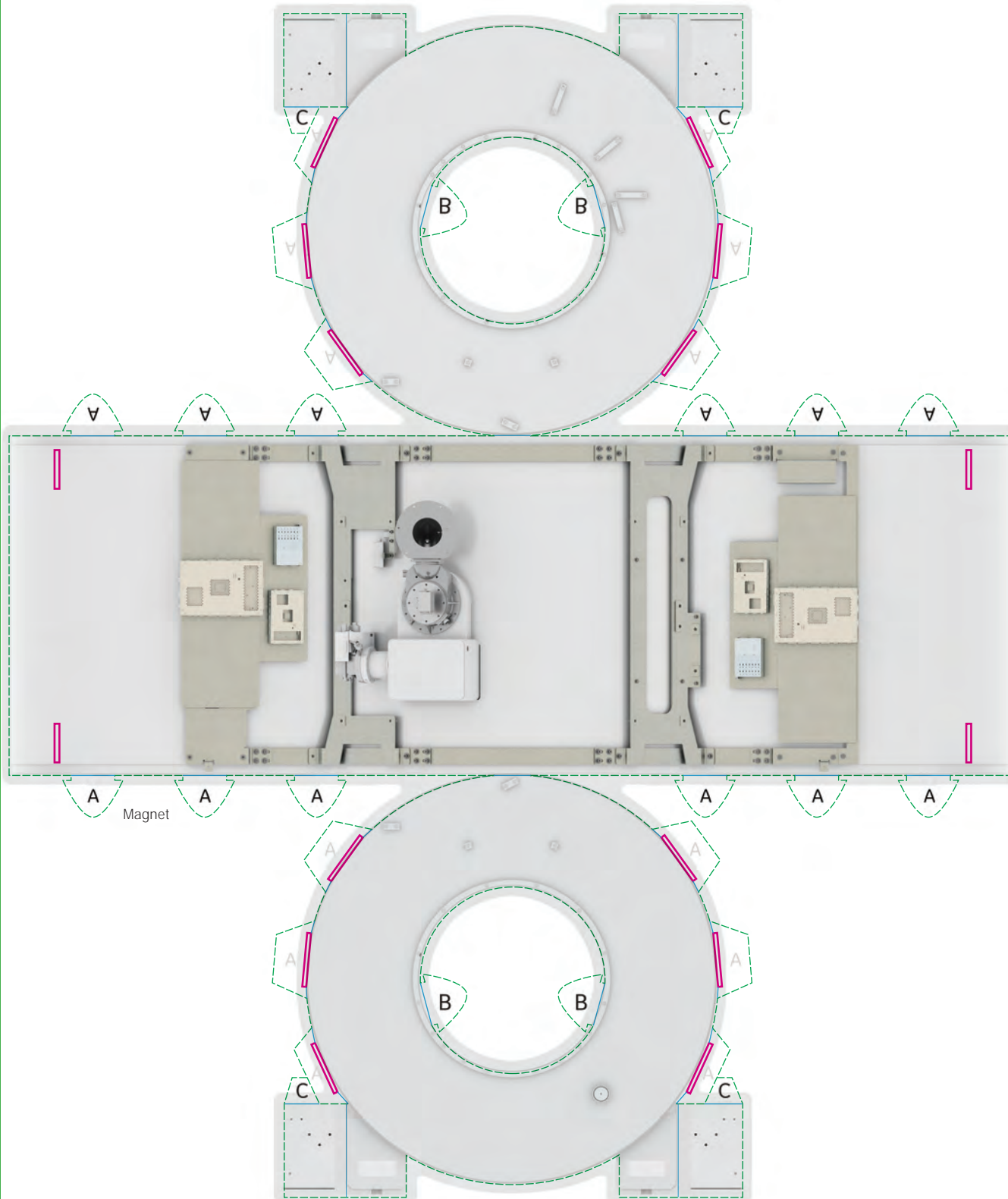

Figure 4

Stick with your magnet



Build

your own SIGNA Explorer Lift model.

Magnet assembly

Curve sides of the magnet into a cylinder and insert A tabs into A slots along one end of the magnet leaving the other side unattached.

Assemble the bore following the bore assembly instructions.

Place assembled bore into the magnet and insert B tabs into B slots on the assembled end of the magnet as shown in Figure 3.

Close the other end of the magnet by first inserting B tabs on the bore into B slots on the inside of the magnet and then inserting A tabs into A slots around the edges of the magnet's face plate.

Insert C tabs located on each magnet foot into corresponding slots on the sides of the magnet as shown in Figure 1.

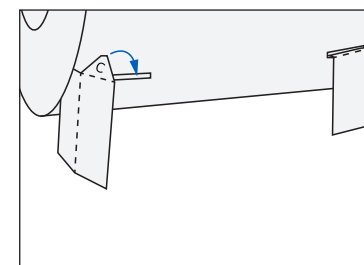
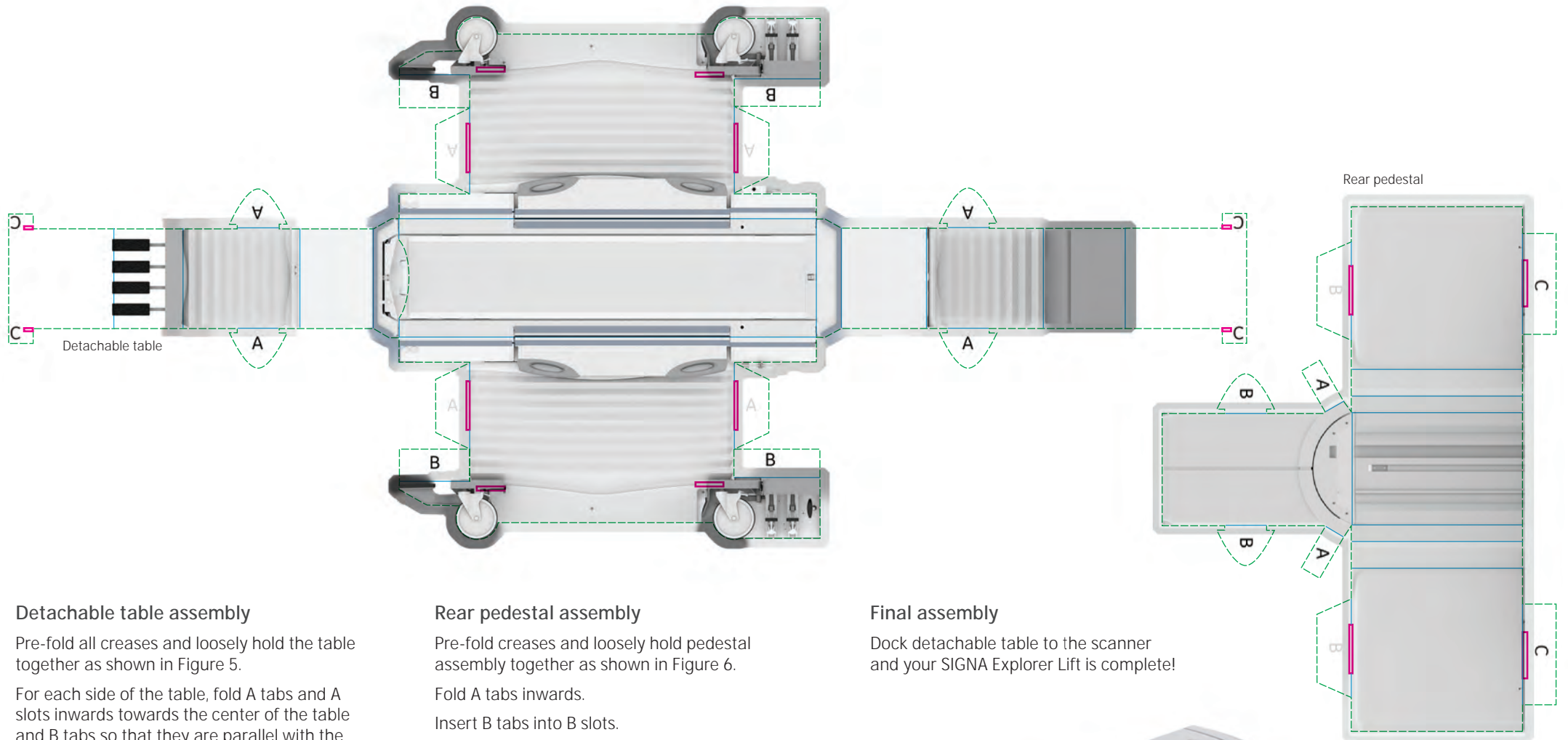

Figure 1

New detachable table



Detachable table assembly

Pre-fold all creases and loosely hold the table together as shown in Figure 5.

For each side of the table, fold A tabs and A slots inwards towards the center of the table and B tabs so that they are parallel with the bottom of the table bed.

Insert A tabs into A slots.

Keeping B tabs parallel with the table bed, fold the final portion under B tabs.

From the inside of the table, insert C tabs into the slots above the wheels to secure it.

Rear pedestal assembly

Pre-fold creases and loosely hold pedestal assembly together as shown in Figure 6.

Fold A tabs inwards.

Insert B tabs into B slots.

Fold C tabs inwards. Attach to the assembled SIGMA Explorer Lift system by inserting the C tabs located on the rear side of the system into the C slots on the rear pedestal.

Final assembly

Dock detachable table to the scanner and your SIGMA Explorer Lift is complete!

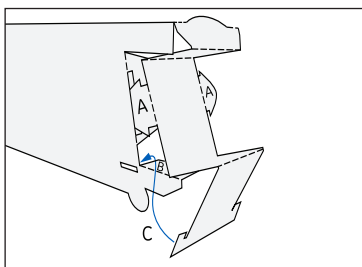

Figure 5

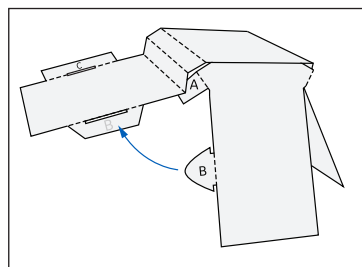
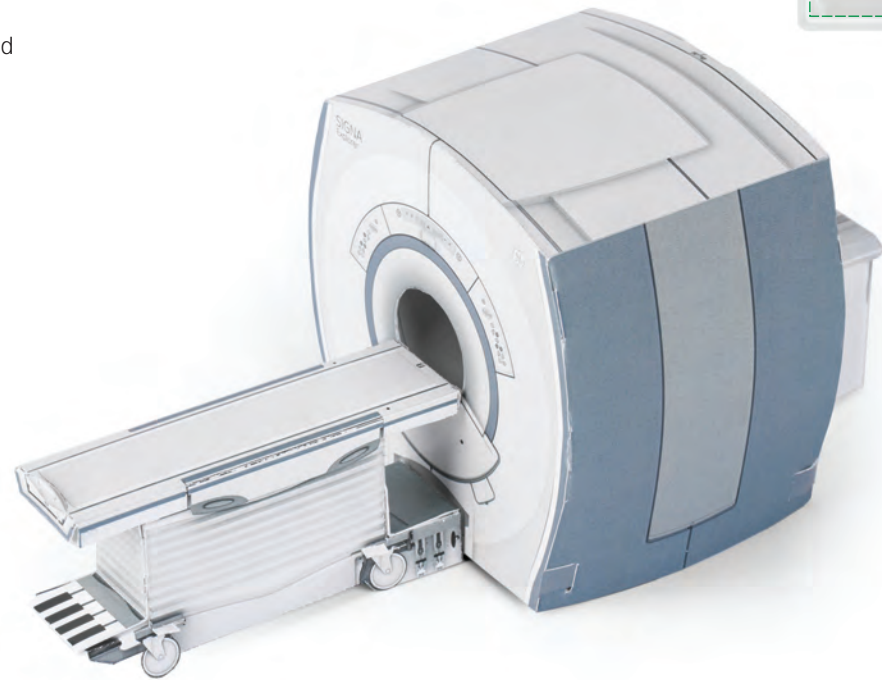

Figure 6







Imagination at work

Product may not be available in all countries and regions.
Contact a GE Healthcare Representative for more information.

GE Healthcare
3200 N. Grandview Blvd.
Waukesha, WI 53188
USA

Data subject to change.

©2015 General Electric Company.

GE, the GE Monogram, imagination at work, SIGNA and Continuum are trademarks of General Electric Company.

Reproduction in any form is forbidden without prior written permission from GE.
Nothing in this material should be used to diagnose or treat any disease or condition.
Readers must consult a healthcare professional.

MR-0495-10.15-EN-US
JB35562XX