

# **Technical Publications**

**Direction DOC0965280**  
*Revision 2*

## **EchoPAC PC version 12** **CONFORMANCE STATEMENT** **for DICOM**

Copyright© 2012 By General Electric Co.

**Do not duplicate**



---

***GE* Ultrasound**

**THIS PAGE LEFT INTENTIONALLY BLANK**

**CONFORMANCE STATEMENT OVERVIEW**

EchoPAC PC is an Ultrasound review station acting as an image display in a DICOM network.

Table 0.1 provides an overview of the network services supported by EchoPAC PC.

**Table 0.1 – NETWORK SERVICES**

<b>SOP Classes</b>	<b>User of Service (SCU)</b>	<b>Provider of Service (SCP)</b>
<b>Transfer</b>		
Ultrasound Multi-frame Image Storage	Yes	Yes / Option (see note)
Ultrasound Image Storage	Yes	Yes / Option (see note)
Ultrasound Multi-frame Image Storage (Retired)	Yes	Yes / Option (see note)
Ultrasound Image Storage (Retired)	Yes	Yes / Option (see note)
Secondary Capture Image Storage	Yes	Yes / Option (see note)
Comprehensive SR	Yes	No
<b>Query/Retrieve</b>		
Study Root Query/Retrieve Information Model – FIND	Yes	No
Study Root Query/Retrieve Information Model – MOVE	Yes	No
<b>Print Management</b>		
Basic Film Session SOP Class	Yes	No
Basic Film Box SOP Class	Yes	No
Basic Grayscale Image Box SOP Class	Yes	No
Basic Color Image Box SOP Class	Yes	No
Basic Grayscale Print Management Meta SOP Class	Yes	No
Basic Color Print Management Meta SOP Class	Yes	No
Printer SOP Class	Yes	No
<b>Workflow Management</b>		
Storage Commitment Push Model SOP Class	Yes	No

Option\*: This means that this service can be purchased separately

Note: Supported when receiving remote image storage requests as a result of examination retrieve requests sent from EchoPAC PC. It is also possible to purchase a separate option for EchoPAC PC in order to accept and support remote requests for image storage which are not part of DICOM Query/Retrieve SOP Classes.

Table 0.2 provides an overview of the Media Storage Application Profiles supported by EchoPAC PC.

**Table 0.2 - MEDIA SERVICES**

<b>Media Storage Application Profile</b>	<b>Write Files (FSC or FSU)</b>	<b>Read Files (FSR)</b>
<b>Compact Disk - Recordable</b>		
US Spatial Calibration Single Frame CD-R (augmented, see 3.3.1)	Yes	Yes
US Spatial Calibration Multi-frame CD-R (augmented, see 3.3.1)	Yes	Yes
<b>Magneto-Optical Disk</b>		
US Spatial Calibration Single Frame 128MB 90mm MOD (Retired, augmented, see 3.3.1)	Yes	Yes
US Spatial Calibration Multi-frame 128MB 90mm MOD (Retired, augmented, see 3.3.1)	Yes	Yes
US Spatial Calibration Single Frame 230MB 90mm MOD (Retired, augmented, see 3.3.1)	Yes	Yes
US Spatial Calibration Multi-frame 230MB 90mm MOD (Retired, augmented, see 3.3.1)	Yes	Yes
US Spatial Calibration Single Frame 540MB 90mm MOD (Retired, augmented, see 3.3.1)	Yes	Yes
US Spatial Calibration Multi-frame 540MB 90mm MOD (Retired, augmented, see 3.3.1)	Yes	Yes
US Spatial Calibration Single Frame 640MB 90mm MOD (Retired, augmented, see 3.3.1)	Yes	Yes
US Spatial Calibration Multi-frame 640MB 90mm MOD (Retired, augmented, see 3.3.1)	Yes	Yes
US Spatial Calibration Single Frame 650MB 130mm MOD (Retired, augmented, see 3.3.1)	Yes	Yes
US Spatial Calibration Multi-frame 650MB 130mm MOD (Retired, augmented, see 3.3.1)	Yes	Yes
US Spatial Calibration Single Frame 1.2GB 130mm MOD (Retired, augmented, see 3.3.1)	Yes	Yes
US Spatial Calibration Multi-frame 1.2GB 130mm MOD (Retired, augmented, see 3.3.1)	Yes	Yes
US Spatial Calibration Single Frame 2.3GB 130mm MOD (Retired, augmented, see 3.3.1)	Yes	Yes
US Spatial Calibration Multi-frame 2.3GB 130mm MOD (Retired, augmented, see 3.3.1)	Yes	Yes
US Spatial Calibration Single Frame 2.3GB 90mm MOD (augmented, see 3.3.1)	Yes	Yes
US Spatial Calibration Multi-frame 2.3GB 90mm MOD (augmented, see 3.3.1)	Yes	Yes
<b>DVD</b>		
US Spatial Calibration Single Frame DVD (augmented, see 3.3.1)	Yes	Yes
US Spatial Calibration Multi-frame DVD (augmented, see 3.3.1)	Yes	Yes

Option\*: This means that this service can be purchased separately

## TABLE OF CONTENTS

<b>1. INTRODUCTION .....</b>	<b>1</b>
<b>1.1 OVERVIEW.....</b>	<b>1</b>
<b>1.2 OVERALL DICOM CONFORMANCE STATEMENT DOCUMENT STRUCTURE.....</b>	<b>2</b>
<b>1.3 INTENDED AUDIENCE .....</b>	<b>3</b>
<b>1.4 SCOPE AND FIELD OF APPLICATION .....</b>	<b>3</b>
<b>1.5 IMPORTANT REMARKS .....</b>	<b>3</b>
<b>1.6 REFERENCES.....</b>	<b>4</b>
<b>1.7 DEFINITIONS .....</b>	<b>4</b>
<b>1.8 SYMBOLS AND ABBREVIATIONS .....</b>	<b>6</b>
<b>2. NETWORK CONFORMANCE STATEMENT .....</b>	<b>8</b>
<b>2.1 INTRODUCTION.....</b>	<b>8</b>
<b>2.2 IMPLEMENTATION MODEL .....</b>	<b>8</b>
2.2.1 Application Data Flow Diagram .....	8
2.2.2 Functional Definition of AE's.....	10
2.2.3 Sequencing of Real-World Activities.....	10
<b>2.3 AE SPECIFICATIONS .....</b>	<b>11</b>
2.3.1 EchoPAC PC AE Specification.....	11
<b>2.4 COMMUNICATION PROFILES.....</b>	<b>21</b>
2.4.1 Supported Communication Stacks (PS 3.8, PS 3.9).....	21
2.4.2 TCP/IP Stack.....	21
2.4.3 Additional Protocols .....	21
2.4.4 IPv4 and IPv6 Support .....	21
<b>2.5 EXTENSIONS / SPECIALIZATIONS / PRIVATIZATIONS .....</b>	<b>21</b>
<b>2.6 CONFIGURATION.....</b>	<b>22</b>
2.6.1 AE Title/Presentation Address Mapping.....	22
2.6.2 Configurable Parameters .....	22
<b>2.7 SUPPORT OF EXTENDED CHARACTER SETS .....</b>	<b>24</b>
<b>2.8 CODES AND CONTROLLED TERMINOLOGY .....</b>	<b>24</b>
2.8.1 Fixed Coded Terminology .....	24
<b>2.9 SECURITY PROFILES .....</b>	<b>24</b>

<b>3.</b>	<b>MEDIA STORAGE CONFORMANCE STATEMENT .....</b>	<b>25</b>
3.1	INTRODUCTION.....	25
3.2	IMPLEMENTATION MODEL .....	25
3.2.1	Application Data Flow Diagram .....	25
3.2.2	Functional Definition of AE's.....	25
3.2.3	Sequencing Requirements .....	26
3.2.4	File Meta Information Options (See PS3.10).....	26
3.3	AE SPECIFICATIONS .....	26
3.3.1	EchoPAC PC AE Specification.....	26
3.4	AUGMENTED AND PRIVATE APPLICATION PROFILES .....	30
3.5	EXTENSIONS, SPECIALIZATIONS, PRIVATIZATIONS OF SOP CLASSES AND TRANSFER SYNTAXES.....	30
3.6	CONFIGURATION.....	31
3.7	SUPPORT OF EXTENDED CHARACTER SETS .....	31
<b>4.</b>	<b>ULTRASOUND (US) INFORMATION OBJECT IMPLEMENTATION.....</b>	<b>32</b>
4.1	INTRODUCTION.....	32
4.2	US IOD IMPLEMENTATION.....	32
4.3	US ENTITY-RELATIONSHIP MODEL .....	32
4.3.1	Entity Descriptions.....	33
4.3.2	EchoPAC PC Mapping of DICOM Entities.....	33
4.4	IOD MODULE TABLE.....	34
4.5	INFORMATION MODULE DEFINITIONS.....	34
4.5.1	Common Patient Entity Modules .....	35
4.5.2	Common Study Entity Modules .....	35
4.5.3	Common Series Entity Modules.....	37
4.5.4	Common Equipment Entity Modules .....	38
4.5.5	Common Image Entity Modules .....	38
4.5.6	General Modules.....	42
4.5.7	US Modules .....	42
<b>5.</b>	<b>ULTRASOUND MULTIFRAME (US MF) INFORMATION OBJECT IMPLEMENTATION</b>	<b>48</b>
5.1	INTRODUCTION.....	48
5.2	US MF IOD IMPLEMENTATION.....	48
5.3	US MF ENTITY-RELATIONSHIP MODEL .....	48
5.3.1	Entity Descriptions.....	49
5.3.2	EchoPAC PC Mapping of DICOM entities .....	49

<b>5.4</b>	<b>IOD MODULE TABLE.....</b>	<b>50</b>
<b>5.5</b>	<b>INFORMATION MODULE DEFINITIONS.....</b>	<b>50</b>
5.5.1	Common Image Modules .....	51
<b>6.</b>	<b>SC INFORMATION OBJECT IMPLEMENTATION .....</b>	<b>52</b>
<b>6.1</b>	<b>INTRODUCTION.....</b>	<b>52</b>
<b>6.2</b>	<b>SC IOD IMPLEMENTATION.....</b>	<b>52</b>
<b>6.3</b>	<b>SC ENTITY-RELATIONSHIP MODEL .....</b>	<b>52</b>
6.3.1	Entity Descriptions.....	53
6.3.2	EchoPAC PC Mapping of DICOM Entities.....	53
<b>6.4</b>	<b>IOD MODULE TABLE.....</b>	<b>54</b>
<b>6.5</b>	<b>INFORMATION MODULE DEFINITIONS.....</b>	<b>54</b>
6.5.1	SC Modules.....	54
<b>7.</b>	<b>SR INFORMATION OBJECT IMPLEMENTATION .....</b>	<b>56</b>
<b>7.1</b>	<b>INTRODUCTION.....</b>	<b>56</b>
<b>7.2</b>	<b>COMPREHENSIVE SR IOD IMPLEMENTATION .....</b>	<b>56</b>
<b>7.3</b>	<b>COMPREHENSIVE SR ENTITY-RELATIONSHIP MODEL .....</b>	<b>56</b>
7.3.1	Entity Descriptions.....	57
7.3.2	EchoPAC PC Mapping of DICOM Entities.....	57
<b>7.4</b>	<b>IOD MODULE TABLE.....</b>	<b>58</b>
<b>7.5</b>	<b>INFORMATION MODULE DEFINITIONS.....</b>	<b>58</b>
7.5.1	SR Document Series Module .....	59
7.5.2	SR Document General Module .....	59
7.5.3	SR Document Content Module .....	60
<b>7.6</b>	<b>STANDARD EXTENDED AND PRIVATE DATA ATTRIBUTES .....</b>	<b>62</b>
<b>7.7</b>	<b>STANDARD EXTENDED AND PRIVATE CONTEXT GROUPS .....</b>	<b>62</b>
<b>7.8</b>	<b>STANDARD EXTENDED AND PRIVATE TEMPLATES.....</b>	<b>62</b>
7.8.1	Standard Extended Templates.....	62
7.8.2	Private Templates.....	62
<b>8.</b>	<b>BASIC DIRECTORY INFORMATION OBJECT IMPLEMENTATION .....</b>	<b>63</b>
<b>8.1</b>	<b>INTRODUCTION.....</b>	<b>63</b>
<b>8.2</b>	<b>BASIC DIRECTORY IOD IMPLEMENTATION.....</b>	<b>63</b>
<b>8.3</b>	<b>BASIC DIRECTORY ENTITY-RELATIONSHIP MODEL .....</b>	<b>63</b>
8.3.1	EchoPAC PC Mapping of DICOM entities .....	63

<b>8.4</b>	<b>IOD MODULE TABLE.....</b>	<b>64</b>
<b>8.5</b>	<b>INFORMATION MODULE DEFINITIONS.....</b>	<b>65</b>
8.5.1	Common File Set identification Modules.....	65
8.5.2	Common Directory Information Modules.....	65
8.5.3	Definition of Specific Directory Records.....	67
<b>8.6</b>	<b>PRIVATE DATA DICTIONARY .....</b>	<b>72</b>
<b>9.</b>	<b>STORAGE COMMITMENT PUSH MODEL SOP CLASS DEFINITION.....</b>	<b>73</b>
<b>9.1</b>	<b>INTRODUCTION.....</b>	<b>73</b>
<b>9.2</b>	<b>STORAGE COMMITMENT PUSH MODEL SOP CLASS DEFINITION .....</b>	<b>73</b>
9.2.1	IOD Description.....	73
9.2.2	DIMSE Service Group.....	73
9.2.3	Operations.....	74
9.2.4	Notifications.....	75
<b>10.</b>	<b>PRINT MANAGEMENT SOP CLASS DEFINITION .....</b>	<b>78</b>
<b>10.1</b>	<b>INTRODUCTION.....</b>	<b>78</b>
<b>10.2</b>	<b>BASIC PRINT MANAGEMENT META SOP CLASSES.....</b>	<b>78</b>
10.2.1	Basic Grayscale Print Management Meta SOP Class.....	78
10.2.2	Basic Color Print Management Meta SOP Class .....	78
<b>10.3</b>	<b>PRINT MANAGEMENT SOP CLASS DEFINITIONS .....</b>	<b>79</b>
10.3.1	Basic Film Session SOP Class .....	79
10.3.2	Basic Film Box SOP Class.....	79
10.3.3	Image Box SOP Class.....	80
10.3.4	Printer SOP Class.....	81
<b>10.4</b>	<b>PRINT MANAGEMENT IODS .....</b>	<b>81</b>
10.4.1	Film Session IOD Module .....	82
10.4.2	Basic Film Box IOD Module Table.....	82
10.4.3	Basic Image Box IOD Module Table.....	82
10.4.4	Printer IOD Module Table.....	82
<b>10.5</b>	<b>INFORMATION MODULE DEFINITIONS.....</b>	<b>82</b>
10.5.1	General Modules.....	83
10.5.2	Print Management Modules .....	83
<b>11.</b>	<b>STUDY ROOT QUERY/RETRIEVE INFORMATION MODEL DEFINITION .....</b>	<b>89</b>
<b>11.1</b>	<b>INTRODUCTION.....</b>	<b>89</b>
<b>11.2</b>	<b>STUDY ROOT INFORMATION MODEL DESCRIPTION .....</b>	<b>89</b>
<b>11.3</b>	<b>STUDY ROOT INFORMATION MODEL ENTITY-RELATIONSHIP MODEL.....</b>	<b>89</b>
11.3.1	Entity Descriptions.....	90
11.3.2	EchoPAC PC Mapping of DICOM entities .....	90



<b>11.4</b>	<b>INFORMATION MODEL KEYS</b> .....	<b>90</b>
11.4.1	Supported Matching .....	91
11.4.2	Study Level .....	91
11.4.3	Series Level.....	92
11.4.4	Image Level.....	93
<b>11.5</b>	<b>PRIVATE DATA DICTIONARY</b> .....	<b>94</b>
<b>12.</b>	<b>ECHOCARDIOGRAPHY PROCEDURE REPORT</b> .....	<b>95</b>
<b>13.</b>	<b>VASCULAR ULTRASOUND PROCEDURE REPORT</b> .....	<b>168</b>
13.1	Usage and Extension of TID 5100 Vascular Ultrasound Report .....	168
13.2	TID 5101 Vascular Patient Characteristics .....	168
13.3	TID 5102 Vascular Procedure Summary Section.....	169
13.4	TID 5103 Vascular Ultrasound Section (extended).....	170
13.5	TID 5104 Vascular Ultrasound Measurement Group .....	170
13.6	GEU Applications and Extensions.....	172
13.7	TID 300 Measurement .....	180
13.8	GE Ultrasound Modes .....	180
13.9	GE Ultrasound Sidedness and Vessel Location .....	180
13.10	SR Mapping Table for Vascular Base Measurement Concept .....	181
13.11	Derivation and Selection.....	182

# 1. INTRODUCTION

## 1.1 OVERVIEW

This DICOM Conformance Statement is divided into Sections as described below:

**Section 1 (Introduction)**, which describes the overall structure, intent, and references for this Conformance Statement

**Section 2 (Network Conformance Statement)**, which specifies the GEHC equipment compliance to the DICOM requirements for the implementation of Networking features.

**Section 3 (Media Storage Conformance Statement)**, which specifies the GEHC equipment compliance to the DICOM requirements for the implementation of Media Storage features.

**Section 4 (Ultrasound Information Object Implementation)**, which specifies the GEHC equipment compliance to DICOM requirements for the implementation of an Ultrasound Medicine Information Object.

**Section 5 (Ultrasound Multi-Frame Information Object Implementation)**, which specifies the GEHC equipment compliance to DICOM requirements for the implementation of an Ultrasound Multi-Frame Information.

**Section 6 (SC Object Implementation)**, which specifies the GEHC equipment compliance to DICOM requirements for the implementation of a Secondary Capture Information Object.

**Section 7 (SR Object Implementation)**, which specifies the GEHC equipment compliance to DICOM requirements for the implementation of a Comprehensive Structured Reporting Information Object.

**Section 8 (Basic Directory Information Object Implementation)**, which specifies the GEHC equipment compliance to DICOM requirements for the implementation of a Basic Directory Information Object.

**Section 9 (Storage Commitment Push Model SOP Class Definition)**, which specifies the GEHC equipment compliance to DICOM requirements for the implementation of the Storage Commitment Push Model Service.

**Section 10 (Basic Print Meta SOP Class Information Object Implementation)**, which specifies the GEHC equipment compliance to DICOM requirements for the implementation of Basic Print Meta SOP Classes (Gray and Color).

**Section 11 (Study Root Query/Retrieve Information Model)**, which specifies the GEHC equipment compliance to DICOM requirements for the Study Root Query/Retrieve Information Model.

**Section 12 (Echocardiography procedure report)**, which specifies how measurements are mapped to Echocardiography Procedure Report (TID 5200) DICOM SR.

**Section 13 (Vascular Ultrasound procedure report)**, which specifies how measurements are mapped to Vascular Ultrasound Procedure Report (TID 5100) DICOM SR.

1.2 OVERALL DICOM CONFORMANCE STATEMENT DOCUMENT STRUCTURE

The Documentation Structure of the GEHC Conformance Statements and their relationship with the DICOM Conformance Statements is shown in the Illustration below.

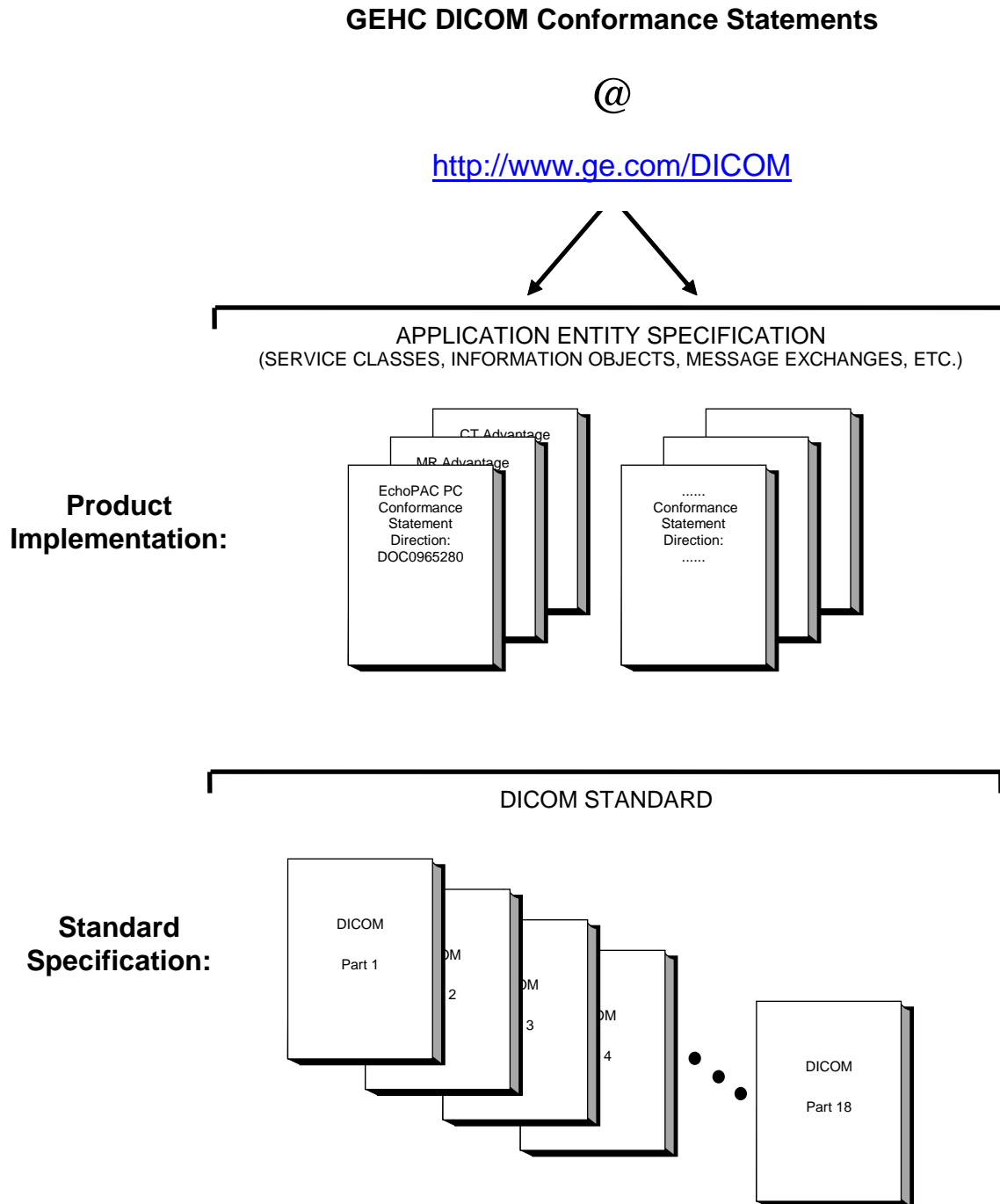

This document specifies the DICOM implementation. It is entitled:

*EchoPAC PC version 12*  
*Conformance Statement for DICOM*  
*Direction DOC0965280*

This DICOM Conformance Statement documents the DICOM Conformance Statement and Technical Specification required to interoperate with the GEHC network interface.

The GEHC Conformance Statement, contained in this document, also specifies the Lower Layer communications which it supports (e.g., TCP/IP). However, the Technical Specifications are defined in the DICOM Part 8 standard.

For more information regarding DICOM, copies of the Standard may be obtained on the Internet at <http://medical.nema.org>. Comments on the Standard may be addressed to:

DICOM Secretariat  
NEMA  
1300 N. 17<sup>th</sup> Street, Suite 1752  
Rosslyn, VA 22209  
USA  
Phone: +1.703.841.3200

### **1.3 INTENDED AUDIENCE**

The reader of this document is concerned with software design and/or system integration issues. It is assumed that the reader of this document is familiar with the DICOM Standard and with the terminology and concepts which are used in that Standard.

### **1.4 SCOPE AND FIELD OF APPLICATION**

It is the intent of this document to provide an unambiguous specification for GEHC implementations. This specification, called a Conformance Statement, includes a DICOM Conformance Statement and is necessary to ensure proper processing and interpretation of GEHC medical data exchanged using DICOM. The GEHC Conformance Statements are available to the public.

The reader of this DICOM Conformance Statement should be aware that different GEHC devices are capable of using different Information Object Definitions. For example, a GEHC CT Scanner may send images using the CT Information Object, MR Information Object, Secondary Capture Object, etc.

Included in this DICOM Conformance Statement are the Module Definitions which define all data elements used by this GEHC implementation. If the user encounters unspecified private data elements while parsing a GEHC Data Set, the user is well advised to ignore those data elements (per the DICOM standard). Unspecified private data element information is subject to change without notice. If, however, the device is acting as a "full fidelity storage device", it should retain and re-transmit all of the private data elements which are sent by GEHC devices.

### **1.5 IMPORTANT REMARKS**

The use of these DICOM Conformance Statements, in conjunction with the DICOM Standards, is intended to facilitate communication with GE imaging equipment. However, **by itself, it is not sufficient to ensure that inter-operation will be successful**. The **user (or user's agent)** needs to proceed with caution and address at least four issues:

- **Integration** - The integration of any device into an overall system of interconnected devices goes beyond the scope of standards (DICOM), and of this introduction and associated DICOM Conformance Statements

when interoperability with non-GE equipment is desired. The responsibility to analyze the applications requirements and to design a solution that integrates GE imaging equipment with non-GE systems is the **user's** responsibility and should not be underestimated. The **user** is strongly advised to ensure that such an integration analysis is correctly performed.

- **Validation** - Testing the complete range of possible interactions between any GE device and non-GE devices, before the connection is declared operational, should not be overlooked. Therefore, the **user** should ensure that any non-GE provider accepts full responsibility for all validation required for their connection with GE devices. This includes the accuracy of the image data once it has crossed the interface between the GE imaging equipment and the non-GE device and the stability of the image data for the intended applications.

Such a validation is required before any clinical use (diagnosis and/or treatment) is performed. It applies when images acquired on GE imaging equipment are processed/displayed on a non-GE device, as well as when images acquired on non-GE equipment is processed/displayed on a GE console or workstation.

- **Future Evolution** - GE understands that the DICOM Standard will evolve to meet the user's growing requirements. GE is actively involved in the development of the DICOM Standard. DICOM will incorporate new features and technologies and GE may follow the evolution of the Standard. The GEHC protocol is based on DICOM as specified in each DICOM Conformance Statement. Evolution of the Standard may require changes to devices, which have implemented DICOM. **In addition, GE reserves the right to discontinue or make changes to the support of communications features (on its products) reflected on by these DICOM Conformance Statements.** The **user** should ensure that any non-GE provider, which connects with GE devices, also plans for the future evolution of the DICOM Standard. Failure to do so will likely result in the loss of function and/or connectivity as the DICOM Standard changes and GE Products are enhanced to support these changes.
- **Interaction** - It is the sole responsibility of the **non-GE provider** to ensure that communication with the interfaced equipment does not cause degradation of GE imaging equipment performance and/or function.

## 1.6 REFERENCES

NEMA PS3 Digital Imaging and Communications in Medicine (DICOM) Standard, available free at <http://medical.nema.org/>

The following document specifies an older DICOM implementation, available at <http://www.ge.com/DICOM> . It is entitled:

*EchoPAC PC version 10  
Conformance Statement for DICOM  
Direction DOC0687360*

## 1.7 DEFINITIONS

Informal definitions are provided for the following terms used in this Conformance Statement. The DICOM Standard is the authoritative source for formal definitions of these terms.

**Abstract Syntax** – the information agreed to be exchanged between applications, generally equivalent to a Service/Object Pair (SOP) Class. Examples: Verification SOP Class, Modality Worklist Information Model Find SOP Class, and Computed Radiography Image Storage SOP Class.

**Application Entity (AE)** – an end point of a DICOM information exchange, including the DICOM network or media interface software; i.e., the software that sends or receives DICOM information objects or messages. A single device may have multiple Application Entities.

**Application Entity Title** – the externally known name of an *Application Entity*, used to identify a DICOM application to other DICOM applications on the network.

**Application Context** – the specification of the type of communication used between *Application Entities*. Example: DICOM network protocol.

**Association** – a network communication channel set up between *Application Entities*.

**Attribute** – a unit of information in an object definition; a data element identified by a *tag*. The information may be a complex data structure (Sequence), itself composed of lower level data elements. Examples: Patient ID (0010,0020), Accession Number (0008,0050), Photometric Interpretation (0028,0004), Procedure Code Sequence (0008,1032).

**Information Object Definition (IOD)** – the specified set of *Attributes* that comprise a type of data object; does not represent a specific instance of the data object, but rather a class of similar data objects that have the same properties. The *Attributes* may be specified as Mandatory (Type 1), Required but possibly unknown (Type 2), or Optional (Type 3), and there may be conditions associated with the use of an Attribute (Types 1C and 2C). Examples: MR Image IOD, CT Image IOD, Print Job IOD.

**Joint Photographic Experts Group (JPEG)** – a set of standardized image compression techniques, available for use by DICOM applications.

**Media Application Profile** – the specification of DICOM information objects and encoding exchanged on removable media (e.g., CDs)

**Module** – a set of *Attributes* within an *Information Object Definition* that are logically related to each other. Example: Patient Module includes Patient Name, Patient ID, Patient Birth Date, and Patient Sex.

**Negotiation** – first phase of *Association* establishment that allows *Application Entities* to agree on the types of data to be exchanged and how that data will be encoded.

**Presentation Context** – the set of DICOM network services used over an *Association*, as negotiated between *Application Entities*; includes *Abstract Syntaxes* and *Transfer Syntaxes*.

**Protocol Data Unit (PDU)** – a packet (piece) of a DICOM message sent across the network. Devices must specify the maximum size packet they can receive for DICOM messages.

**Security Profile** – a set of mechanisms, such as encryption, user authentication, or digital signatures, used by an *Application Entity* to ensure confidentiality, integrity, and/or availability of exchanged DICOM data

**Service Class Provider (SCP)** – role of an *Application Entity* that provides a DICOM network service; typically, a server that performs operations requested by another *Application Entity* (*Service Class User*). Examples: Picture Archiving and Communication System (image storage SCP, and image query/retrieve SCP), Radiology Information System (modality worklist SCP).

**Service Class User (SCU)** – role of an *Application Entity* that uses a DICOM network service; typically, a client. Examples: imaging modality (image storage SCU, and modality worklist SCU), imaging workstation (image query/retrieve SCU)

**Service/Object Pair (SOP) Class** – the specification of the network or media transfer (service) of a particular type of data (object); the fundamental unit of DICOM interoperability specification. Examples: Ultrasound Image Storage Service, Basic Grayscale Print Management.

**Service/Object Pair (SOP) Instance** – an information object; a specific occurrence of information exchanged in a *SOP Class*. Examples: a specific x-ray image.

**Tag** – a 32-bit identifier for a data element, represented as a pair of four digit hexadecimal numbers, the “group” and the “element”. If the “group” number is odd, the tag is for a private (manufacturer-specific) data element. Examples: (0010,0020) [Patient ID], (07FE,0010) [Pixel Data], (0019,0210) [private data element]

**Transfer Syntax** – the encoding used for exchange of DICOM information objects and messages. Examples: *JPEG* compressed (images), little endian explicit value representation.

**Unique Identifier (UID)** – a globally unique “dotted decimal” string that identifies a specific object or a class of objects; an ISO-8824 Object Identifier. Examples: Study Instance UID, SOP Class UID, SOP Instance UID.

**Value Representation (VR)** – the format type of an individual DICOM data element, such as text, an integer, a person’s name, or a code. DICOM information objects can be transmitted with either explicit identification of the type of each data element (Explicit VR), or without explicit identification (Implicit VR); with Implicit VR, the receiving application must use a DICOM data dictionary to look up the format of each data element.

## 1.8 SYMBOLS AND ABBREVIATIONS

AE	Application Entity
AET	Application Entity Title
CD-R	Compact Disk Recordable
DHCP	Dynamic Host Configuration Protocol
DICOM	Digital Imaging and Communications in Medicine
DNS	Domain Name System
FSC	File-Set Creator
FSU	File-Set Updater
FSR	File-Set Reader
HIS	Hospital Information System
HL7	Health Level 7 Standard
IHE	Integrating the Healthcare Enterprise
IOD	Information Object Definition
IPv4	Internet Protocol version 4
IPv6	Internet Protocol version 6
ISO	International Organization for Standards
JPEG	Joint Photographic Experts Group
LUT	Look-up Table
MPPS	Modality Performed Procedure Step
MSPS	Modality Scheduled Procedure Step
MTU	Maximum Transmission Unit (IP)

MWL	Modality Worklist
O	Optional (Key Attribute)
OSI	Open Systems Interconnection
PACS	Picture Archiving and Communication System
PDU	Protocol Data Unit
R	Required (Key Attribute)
RIS	Radiology Information System
SC	Secondary Capture
SCP	Service Class Provider
SCU	Service Class User
SOP	Service-Object Pair
SPS	Scheduled Procedure Step
SR	Structured Reporting
TCP/IP	Transmission Control Protocol/Internet Protocol
U	Unique (Key Attribute)
UL	Upper Layer
US	Ultrasound
VR	Value Representation



## **2. NETWORK CONFORMANCE STATEMENT**

### **2.1 INTRODUCTION**

This section of the DICOM Conformance Statement specifies the compliance to DICOM conformance requirements for the relevant **Networking** features for EchoPAC PC version 12. Note that the format of this section strictly follows the format defined in DICOM Standard PS 3.2 (Conformance). Please refer to that part of the standard while reading this section.

EchoPAC PC is an Ultrasound workstation running on a commercial computer. It allows for the following DICOM functionality:

- Sending and receiving Echo messages to and from DICOM Verification SCP and client.
- Exporting DICOM images and results to a DICOM SCP or saving the DICOM images and results to DICOM media format.
- Browsing and viewing DICOM images on DICOM media format.
- Sending storage commitment requests (and receiving replies) to a DICOM Storage Commitment SCP.
- Printing images to a DICOM Printer.
- Querying and retrieving examinations from a DICOM Query/Retrieve SCP.
- Receiving ultrasound images and storing them.

### **2.2 IMPLEMENTATION MODEL**

#### **2.2.1 Application Data Flow Diagram**

The Basic and Specific Application models for this device are shown in the following illustration:

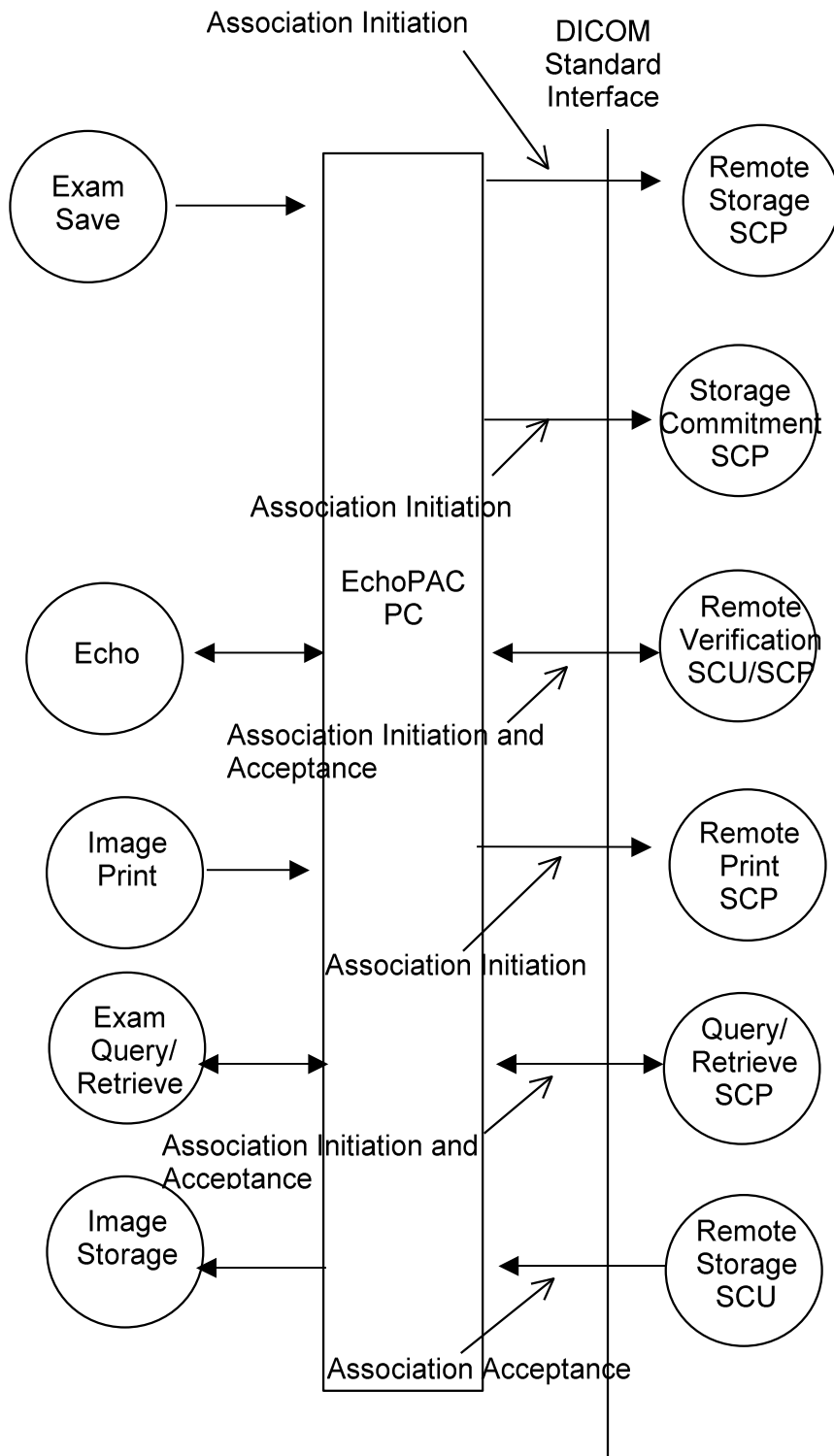

There are five local real-world activities that occur in EchoPAC PC - **Exam Save, Echo, Image Print, Exam Query/Retrieve** and **Image Storage**.

**Exam save** initiates a connection with the DICOM SCP and transmits images and results to the DICOM SCP. If Storage Commitment is configured a commitment request will be sent for the images and results.

**Echo** initiates a connection with the DICOM SCP, posts a Verification request and closes the connection. It also responds to incoming Verification requests (for service use).

**Image Print** will send images to a DICOM Print SCP.

**Exam Query/Retrieve** initiates a connection with the DICOM SCP, performs a query and retrieves selected examination.

**Image Storage** accepts connections from DICOM SCUs, receives ultrasound images and stores them.

### 2.2.2 Functional Definition of AE's

Application Entity EchoPAC PC supports the following functions:

- Initiates a DICOM association to send images and results.
- Transmits DICOM images and results to the DICOM Storage SCP.
- Initiates a DICOM verification to assist in network diagnostics.
- Responds to DICOM verification requests from other devices.
- Initiates a DICOM association to request storage commitment of images.
- Responds to replies for storage commitment requests of images.
- Initiates a DICOM association to print images.
- Initiates a DICOM association to query for and retrieve examinations.
- Responds to replies for examination retrieve requests.
- Responds to storage requests triggered by examination retrieve requests.

### 2.2.3 Sequencing of Real-World Activities

Not applicable.

**2.3 AE SPECIFICATIONS**

**2.3.1 EchoPAC PC AE Specification**

This Application Entity provides Standard Conformance to the following DICOM SOP Classes as an **SCU**:

<b>SOP Class Name</b>	<b>SOP Class UID</b>
Ultrasound Multi-frame Image Storage	1.2.840.10008.5.1.4.1.1.3.1
Ultrasound Multi-frame Image Storage (Retired)	1.2.840.10008.5.1.4.1.1.3
Ultrasound Image Storage	1.2.840.10008.5.1.4.1.1.6.1
Ultrasound Image Storage (Retired)	1.2.840.10008.5.1.4.1.1.6
Secondary Capture Image Storage	1.2.840.10008.5.1.4.1.1.7
Verification SOP Class	1.2.840.10008.1.1
Storage Commitment Push Model SOP Class	1.2.840.10008.1.20.1
Basic Grayscale Print Management Meta SOP Class	1.2.840.10008.5.1.1.9
Basic Color Print Management Meta SOP Class	1.2.840.10008.5.1.1.18
Study Root Query/Retrieve Information Model – FIND	1.2.840.10008.5.1.4.1.2.2.1
Study Root Query/Retrieve Information Model – MOVE	1.2.840.10008.5.1.4.1.2.2.2
Comprehensive Structured Report Storage	1.2.840.10008.5.1.4.1.1.88.33

This Application Entity provides Standard Conformance to the following DICOM SOP Classes as an **SCP**:

<b>SOP Class Name</b>	<b>SOP Class UID</b>
Ultrasound Multi-frame Image Storage	1.2.840.10008.5.1.4.1.1.3.1
Ultrasound Multi-frame Image Storage (Retired)	1.2.840.10008.5.1.4.1.1.3
Ultrasound Image Storage	1.2.840.10008.5.1.4.1.1.6.1
Ultrasound Image Storage (Retired)	1.2.840.10008.5.1.4.1.1.6
Secondary Capture Image Storage	1.2.840.10008.5.1.4.1.1.7
Verification SOP Class	1.2.840.10008.1.1

**2.3.1.1 Association Establishment Policies**

**2.3.1.1.1 General**

The DICOM Application Context Name (ACN), which is always proposed, is:

<b>Application Context Name</b>	<b>1.2.840.10008.3.1.1.1</b>
---------------------------------	------------------------------

The Maximum Length PDU negotiation is included in all association establishment requests. The maximum length PDU for an association initiated by EchoPAC PC is (not configurable):

<b>Maximum Length PDU</b>	<b>32768</b>
---------------------------	--------------

The SOP Class Extended Negotiation is not supported.

The user information Items sent by this product are:

- Maximum PDU Length
- Implementation UID
- Implementation Version Name

**2.3.1.1.2 Number of Associations**

The EchoPAC PC AE will initiate multiple DICOM associations. Maximum number of simultaneous associations is 2.

**2.3.1.1.3 Asynchronous Nature**

Asynchronous mode is not supported. All operations will be performed synchronously.

**2.3.1.1.4 Implementation Identifying Information**

The Implementation UID for this DICOM Implementation is:

<b>EchoPAC PC Implementation UID</b>	<b>1.2.840.113619.6.118</b>
--------------------------------------	-----------------------------

The Implementation Version Name for this DICOM Implementation is:

<b>EchoPAC PC Implementation Version Name</b>	<b>EchoPAC_PC_12</b>
---	----------------------

Note: The Implementation Version Name may change in the future without modification of this document.

**2.3.1.2 Association Initiation Policy**

The EchoPAC PC AE attempts to establish a new association with a remote device due to six Real-World Activities:

- Exam save initiated by the operator for images and results and sending request for Storage Commitment.
- Verification, which verifies application level communication between peer DICOM AE’s for service purposes.
- Print initiated by the operator for a specific image or group of images.
- Exam Query/Retrieve initiated by the operator for receiving examination information and selecting examination to retrieve.

**2.3.1.2.1 Real-World Activity A (‘Exam save’ Operation)**

**2.3.1.2.1.1 Associated Real-World Activity**

Upon a request by the operator (manual or automatic), images will be sent to a DICOM Storage SCP.

**2.3.1.2.1.2 Proposed Presentation Context Tables**

The Proposed Presentation Context Table depends on compression (configurable) according to the following table:

<b>Presentation Context Table – Proposed</b>					
<b>Abstract Syntax</b>		<b>Transfer Syntax</b>		<b>Role</b>	<b>Extended Negotiation</b>
<b>Name</b>	<b>UID</b>	<b>Name List</b>	<b>UID List</b>		
<b>Presentation Context Table: Compression set to None</b>					
Secondary Capture Image Storage	1.2.840.10008.5.1.4.1.1.7	Explicit VR Little Endian Explicit VR Big Endian Implicit VR Little Endian	1.2.840.10008.1.2.1 1.2.840.10008.1.2.2 1.2.840.10008.1.2	SCU	None
Ultrasound Image Storage	1.2.840.10008.5.1.4.1.1.6.1	Explicit VR Little Endian Explicit VR Big Endian Implicit VR Little Endian	1.2.840.10008.1.2.1 1.2.840.10008.1.2.2 1.2.840.10008.1.2	SCU	None
Ultrasound Multi-frame Image Storage	1.2.840.10008.5.1.4.1.1.3.1	Explicit VR Little Endian Explicit VR Big Endian Implicit VR Little Endian	1.2.840.10008.1.2.1 1.2.840.10008.1.2.2 1.2.840.10008.1.2	SCU	None
Ultrasound Image Storage (retired)	1.2.840.10008.5.1.4.1.1.6	Explicit VR Little Endian Explicit VR Big Endian Implicit VR Little Endian	1.2.840.10008.1.2.1 1.2.840.10008.1.2.2 1.2.840.10008.1.2	SCU	None
Ultrasound Multi-frame Image Storage (retired)	1.2.840.10008.5.1.4.1.1.3	Explicit VR Little Endian Explicit VR Big Endian Implicit VR Little Endian	1.2.840.10008.1.2.1 1.2.840.10008.1.2.2 1.2.840.10008.1.2	SCU	None
<b>Presentation Context Table: Compression set to RLE</b>					
Secondary Capture Image Storage	1.2.840.10008.5.1.4.1.1.7	Run Length Encoding, RLE Explicit VR Little Endian Explicit VR Big Endian Implicit VR Little Endian	1.2.840.10008.1.2.5 1.2.840.10008.1.2.1 1.2.840.10008.1.2.2 1.2.840.10008.1.2	SCU	None
Ultrasound Image Storage	1.2.840.10008.5.1.4.1.1.6.1	Run Length Encoding, RLE Explicit VR Little Endian Explicit VR Big Endian Implicit VR Little Endian	1.2.840.10008.1.2.5 1.2.840.10008.1.2.1 1.2.840.10008.1.2.2 1.2.840.10008.1.2	SCU	None
Ultrasound Multi-frame Image Storage	1.2.840.10008.5.1.4.1.1.3.1	Run Length Encoding, RLE	1.2.840.10008.1.2.5	SCU	None

		Explicit VR Little Endian Explicit VR Big Endian Implicit VR Little Endian	1.2.840.10008.1.2.1 1.2.840.10008.1.2.2 1.2.840.10008.1.2		
Ultrasound Image Storage (retired)	1.2.840.10008.5.1.4.1.1.6	Run Length Encoding, RLE Explicit VR Little Endian Explicit VR Big Endian Implicit VR Little Endian	1.2.840.10008.1.2.5  1.2.840.10008.1.2.1 1.2.840.10008.1.2.2 1.2.840.10008.1.2	SCU	None
Ultrasound Multi-frame Image Storage (retired)	1.2.840.10008.5.1.4.1.1.3	Run Length Encoding, RLE Explicit VR Little Endian Explicit VR Big Endian Implicit VR Little Endian	1.2.840.10008.1.2.5  1.2.840.10008.1.2.1 1.2.840.10008.1.2.2 1.2.840.10008.1.2	SCU	None
<b>Presentation Context Table: Compression set to JPEG</b>					
Secondary Capture Image Storage	1.2.840.10008.5.1.4.1.1.7	JPEG Baseline coding Process 1	1.2.840.10008.1.2.4.5 0	SCU	None
Ultrasound Image Storage	1.2.840.10008.5.1.4.1.1.6.1	JPEG Baseline coding Process 1	1.2.840.10008.1.2.4.5 0	SCU	None
Ultrasound Multi-frame Image Storage	1.2.840.10008.5.1.4.1.1.3.1	JPEG Baseline coding Process 1	1.2.840.10008.1.2.4.5 0	SCU	None
Ultrasound Image Storage	1.2.840.10008.5.1.4.1.1.6	JPEG Baseline coding Process 1	1.2.840.10008.1.2.4.5 0	SCU	None
Ultrasound Multi-frame Image Storage (retired)	1.2.840.10008.5.1.4.1.1.3	JPEG Baseline coding Process 1	1.2.840.10008.1.2.4.5 0	SCU	None
<b>Presentation Context Table for Structured Reports</b>					
Comprehensive Structured Report	1.2.840.10008.5.1.4.1.1.88.33	Explicit VR Little Endian Explicit VR Big Endian Implicit VR Little Endian	1.2.840.10008.1.2.1 1.2.840.10008.1.2.2 1.2.840.10008.1.2	SCU	None

This operation also sends a Storage Commitment Request, with the following proposed presentation context. The result from the SCP is expected on another association for the Storage Commitment result.

<b>Presentation Context Table Proposed</b>					
<b>Abstract Syntax</b>		<b>Transfer Syntax</b>		<b>Role</b>	<b>Extended Negotiation</b>
<b>Name</b>	<b>UID</b>	<b>Name List</b>	<b>UID List</b>		
Storage Commitment Push Model SOP Class	1.2.840.10008.1.20.1	Explicit VR Little Endian Explicit VR Big Endian Implicit VR Little Endian	1.2.840.10008.1.2.1 1.2.840.10008.1.2.2 1.2.840.10008.1.2	SCU	None

**2.3.1.2.1.2.1 SOP Specific DICOM Conformance Statement for all Storage and Storage Commitment SOP Classes**

For these SOP classes (Storage and Storage Commitment), all status codes with status Refused or Error are treated as failures and terminate the association and operation. On a failure, the request will be put in a holding queue for the user to manually retry the request. All status codes with status Warning or Success are treated as successes.

**2.3.1.2.2 Real-World Activity B ('Echo' Operation)**

**2.3.1.2.2.1 Associated Real-World Activity**

The user may initiate a DICOM Verification Request in the Config screen.

Associations will be released upon the receipt of each C-ECHO confirmation.

In the event that the SCP does not respond, the operation will time out, close the association and inform the user.

**2.3.1.2.2.2 Proposed Presentation Context Table**

<b>Presentation Context Table - Proposed</b>					
<b>Abstract Syntax</b>		<b>Transfer Syntax</b>		<b>Role</b>	<b>Extended Negotiation</b>
<b>Name</b>	<b>UID</b>	<b>Name List</b>	<b>UID List</b>		
Verification SOP Class	1.2.840.10008.1.1	Explicit VR Little Endian Explicit VR Big Endian Implicit VR Little Endian	1.2.840.10008.1.2.1 1.2.840.10008.1.2.2 1.2.840.10008.1.2	SCU	None

**2.3.1.2.3 Real-World Activity C ('Image Print' Operation)**

**2.3.1.2.3.1 Associated Real-World Activity**

Upon a request by the operator, print jobs will be sent to a DICOM Print SCP. If an error occurs during the transmission, the current association is released and a new association initiated. The maximum number of retries is configurable.

**2.3.1.2.3.2 Proposed Presentation Context Tables**

The following table is used:

<b>Presentation Context Table - Proposed</b>					
<b>Abstract Syntax</b>		<b>Transfer Syntax</b>		<b>Role</b>	<b>Extended Negotiation</b>
<b>Name</b>	<b>UID</b>	<b>Name List</b>	<b>UID List</b>		
Basic Grayscale Print Management Meta SOP Class	1.2.840.10008.5.1.1.9	Explicit VR Little Endian Explicit VR Big Endian Implicit VR Little Endian	1.2.840.10008.1.2.1 1.2.840.10008.1.2.2 1.2.840.10008.1.2	SCU	None
Basic Color Print Management Meta SOP Class	1.2.840.10008.5.1.1.18	Explicit VR Little Endian Explicit VR Big Endian Implicit VR Little Endian	1.2.840.10008.1.2.1 1.2.840.10008.1.2.2 1.2.840.10008.1.2	SCU	None

**2.3.1.2.3.2.1 SOP Specific DICOM Conformance Statement for all Print Management SOP Classes**

All status codes with status Refused or Error are treated as failures and terminate the association and operation. All status codes with status Warning or Success are treated as successes.



**2.3.1.2.4 Real-World Activity D (‘Exam Query/Retrieve’ Operation)**

**2.3.1.2.4.1 Associated Real-World Activity**

The user may initiate a DICOM Exam Query in Search screen, which will send a C-FIND-RQ to the Query/Retrieve SCP.

Associations will be released upon the receipt of C-FIND-RSP confirmation.

The user may then select an examination to be retrieved, using the C-MOVE-RQ command to the Query/Retrieve SCP. The result from the SCP is expected on another association for the retrieved examinations.

**2.3.1.2.4.2 Proposed Presentation Context Tables**

Presentation Context Table – Proposed					
Abstract Syntax		Transfer Syntax		Role	Extended Negotiation
Name	UID	Name List	UID List		
Study Root Query/Retrieve Information Model - FIND	1.2.840.10008.5.1.4.1.2.2.1	Explicit VR Little Endian	1.2.840.10008.1.2.1	SCU	None
		Explicit VR Big Endian	1.2.840.10008.1.2.2		
		Implicit VR Little Endian	1.2.840.10008.1.2		
Study Root Query/Retrieve Information Model - MOVE	1.2.840.10008.5.1.4.1.2.2.2	Explicit VR Little Endian	1.2.840.10008.1.2.1	SCU	None
		Explicit VR Big Endian	1.2.840.10008.1.2.2		
		Implicit VR Little Endian	1.2.840.10008.1.2		

**2.3.1.2.4.2.1 SOP Specific DICOM Conformance Statement for Study Root Query/Retrieve Information Model - FIND SOP Classes**

All status codes with status Refused or Error are treated as failures and terminate the association and operation. All status codes with status Warning or Success are treated as successes.

EchoPAC PC will only support hierarchical query.

**2.3.1.2.4.2.2 SOP Specific DICOM Conformance Statement for Study Root Query/Retrieve Information Model - MOVE SOP Classes**

All status codes with status Refused or Error are treated as failures and terminate the association and operation. All status codes with status Warning or Success are treated as successes.

**2.3.1.3 Association Acceptance Policy**

The AE accepts an association when EchoPAC PC receives an N-EVENT-REPORT from a Storage Commitment request, a Verification Request from another network device, a C-STORE request as part of a Query/Retrieve operation or a remote request to store images.

**2.3.1.3.1 Real-World Activity A – (‘Exam Save’ operation)**

**2.3.1.3.1.1 Associated Real-World Activity**

An incoming N-EVENT-REPORT will cause the AE to accept the association (using SCP/SCU Role Negotiation) and update the internal Storage Commitment statuses.

**2.3.1.3.1.2 Accepted Presentation Context Table**

<b>Presentation Context Table Accepted</b>					
<b>Abstract Syntax</b>		<b>Transfer Syntax</b>		<b>Role</b>	<b>Extended Negotiation</b>
<b>Name</b>	<b>UID</b>	<b>Name List</b>	<b>UID List</b>		
Storage Commitment Push Model SOP Class	1.2.840.10008.1.20.1	Explicit VR Little Endian Explicit VR Big Endian Implicit VR Little Endian	1.2.840.10008.1.2.1 1.2.840.10008.1.2.2 1.2.840.10008.1.2	SCU	None

**2.3.1.3.1.2.1 SOP Specific DICOM Conformance Statement for Storage Commitment SOP Class**

The AE provides standard conformance to the Storage Commitment SOP Class as an SCP for the N-EVENT-REPORT. The default port number is 104.

**2.3.1.3.1.3 Presentation Context Acceptance Criterion**

No criterion.

**2.3.1.3.1.4 Transfer Syntax Selection Policies**

The selected transfer syntax is based on the proposed transfer syntax list. The priority order is Explicit VR Little Endian, Explicit VR Big Endian and Implicit VR Little Endian.

**2.3.1.3.2 Real-World Activity B – (‘Echo’ operation)**

**2.3.1.3.2.1 Associated Real-World Activity**

An incoming Verification Request will cause the AE to accept the association and respond with a Verification Response.

**2.3.1.3.2.2 Accepted Presentation Context Table**

<b>Presentation Context Table – Accepted</b>					
<b>Abstract Syntax</b>		<b>Transfer Syntax</b>		<b>Role</b>	<b>Extended Negotiation</b>
<b>Name</b>	<b>UID</b>	<b>Name List</b>	<b>UID List</b>		
Verification SOP Class	1.2.840.10008.1.1	Explicit VR Little Endian Explicit VR Big Endian Implicit VR Little Endian	1.2.840.10008.1.2.1 1.2.840.10008.1.2.2 1.2.840.10008.1.2	SCP	None

**2.3.1.3.2.2.1 SOP Specific DICOM Conformance Statement for Verify SOP Class**

The AE provides standard conformance to the Verification SOP Class as an SCP. The default port number is 104.

**2.3.1.3.2.3 Presentation Context Acceptance Criterion**

No criterion.

**2.3.1.3.2.4 Transfer Syntax Selection Policies**

The selected transfer syntax is based on the proposed transfer syntax list. The priority order is Explicit VR Little Endian, Explicit VR Big Endian and Implicit VR Little Endian.

**2.3.1.3.3 Real-World Activity D ('Exam Query/Retrieve' Operation)****2.3.1.3.3.1 Associated Real-World Activity**

If the user has initiated a retrieve by a C-MOVE-RQ, the AE will accept associations for C-STORE-RQs. The images will be stored locally.

**2.3.1.3.3.2 Accepted Presentation Context Table**

Presentation Context Table - Accepted					
Abstract Syntax		Transfer Syntax		Role	Extended Negotiation
Name	UID	Name List	UID List		
Ultrasound Image Storage	1.2.840.10008.5.1.4.1.1.6.1	JPEG Baseline coding Process 1 Explicit VR Little Endian Explicit VR Big Endian Implicit VR Little Endian Run Length Encoding, RLE	1.2.840.10008.1.2.4.50  1.2.840.10008.1.2.1 1.2.840.10008.1.2.2 1.2.840.10008.1.2 1.2.840.10008.1.2.5	SCP	None
Ultrasound Multi-frame Image Storage	1.2.840.10008.5.1.4.1.1.3.1	JPEG Baseline coding Process 1 Explicit VR Little Endian Explicit VR Big Endian Implicit VR Little Endian Run Length Encoding, RLE	1.2.840.10008.1.2.4.50  1.2.840.10008.1.2.1 1.2.840.10008.1.2.2 1.2.840.10008.1.2 1.2.840.10008.1.2.5	SCP	None
Ultrasound Image Storage (retired)	1.2.840.10008.5.1.4.1.1.6	JPEG Baseline coding Process 1 Explicit VR Little Endian Explicit VR Big Endian Implicit VR Little Endian Run Length Encoding, RLE	1.2.840.10008.1.2.4.50  1.2.840.10008.1.2.1 1.2.840.10008.1.2.2 1.2.840.10008.1.2 1.2.840.10008.1.2.5	SCP	None
Ultrasound Multi-frame Image Storage (retired)	1.2.840.10008.5.1.4.1.1.3	JPEG Baseline coding Process 1 Explicit VR Little Endian Explicit VR Big Endian Implicit VR Little Endian Run Length Encoding, RLE	1.2.840.10008.1.2.4.50  1.2.840.10008.1.2.1 1.2.840.10008.1.2.2 1.2.840.10008.1.2 1.2.840.10008.1.2.5	SCP	None

Secondary Capture Image Storage	1.2.840.10008.5.1.4.1.1.7	JPEG Baseline coding Process 1	1.2.840.10008.1.2.4.50	SCP	None
		Explicit VR Little Endian	1.2.840.10008.1.2.1		
		Explicit VR Big Endian	1.2.840.10008.1.2.2		
		Implicit VR Little Endian	1.2.840.10008.1.2		
		Run Length Encoding, RLE	1.2.840.10008.1.2.5		

**2.3.1.3.3.2.1 SOP Specific DICOM Conformance Statement for Storage SOP Classes**

The AE provides standard conformance to the Storage SOP Classes as an SCP. The default port number is 104.

**2.3.1.3.3.3 Presentation Context Acceptance Criterion**

No criterion.

**2.3.1.3.3.4 Transfer Syntax Selection Policies**

The selected transfer syntax is based on the proposed transfer syntax list. The priority order is JPEG Baseline, Run Length Encoding RLE, Explicit VR Little Endian, Explicit VR Big Endian and Implicit VR Little Endian.

**2.3.1.3.4 Real-World Activity E ('Image Storage' Operation)**

**2.3.1.3.4.1 Associated Real-World Activity**

If so configured, the EchoPAC PC AE will accept an association from a remote Application Entity to transfer images to the EchoPAC PC AE for image storage. This association supports the Real-World Activity Remote Request for Image Storage.

**2.3.1.3.4.2 Accepted Presentation Context Table**

The EchoPAC PC AE will accept multiple Presentation Contexts for the Remote Request for Image Storage activity as shown in the following table. A single association may be used both for this activity and for any of the other activities with the EchoPAC PC AE as the association acceptor.

<b>Presentation Context Table – Accepted</b>					
<b>Abstract Syntax</b>		<b>Transfer Syntax</b>		<b>Role</b>	<b>Extended Negotiation</b>
<b>Name</b>	<b>UID</b>	<b>Name List</b>	<b>UID List</b>		
Ultrasound Multi-frame Image Storage	1.2.840.10008.5.1.4.1.1.3.1	Implicit VR Little Endian	1.2.840.10008.1.2	SCP	None
		Explicit VR Little Endian	1.2.840.10008.1.2.1		
		Explicit VR Big Endian	1.2.840.10008.1.2.2		
		JPEG Baseline coding Process 1	1.2.840.10008.1.2.4.50		
		RLE Lossless	1.2.840.10008.1.2.5		
Ultrasound Image Storage	1.2.840.10008.5.1.4.1.1.6.1	Implicit VR Little Endian	1.2.840.10008.1.2	SCP	None
		Explicit VR Little Endian	1.2.840.10008.1.2.1		

		Explicit VR Big Endian	1.2.840.10008.1.2.2		
		JPEG Baseline coding Process 1	1.2.840.10008.1.2.4.50		
		RLE Lossless	1.2.840.10008.1.2.5		
Secondary Capture Image Storage	1.2.840.10008.5.1.4.1.1.7	Implicit VR Little Endian	1.2.840.10008.1.2	SCP	None
		Explicit VR Little Endian	1.2.840.10008.1.2.1		
		Explicit VR Big Endian	1.2.840.10008.1.2.2		
Ultrasound Multi-frame Image Storage (retired)	1.2.840.10008.5.1.4.1.1.3	Implicit VR Little Endian	1.2.840.10008.1.2	SCP	None
		Explicit VR Little Endian	1.2.840.10008.1.2.1		
		Explicit VR Big Endian	1.2.840.10008.1.2.2		
		JPEG Baseline coding Process 1	1.2.840.10008.1.2.4.50		
		RLE Lossless	1.2.840.10008.1.2.5		
Ultrasound Image Storage (retired)	1.2.840.10008.5.1.4.1.1.6	Implicit VR Little Endian	1.2.840.10008.1.2	SCP	None
		Explicit VR Little Endian	1.2.840.10008.1.2.1		
		Explicit VR Big Endian	1.2.840.10008.1.2.2		
		JPEG Baseline coding Process 1	1.2.840.10008.1.2.4.50		
		RLE Lossless	1.2.840.10008.1.2.5		

**2.3.1.3.4.2.1 SOP Specific DICOM Conformance Statement for all Storage SOP Classes**

The EchoPAC PC AE provides Level 2 (FULL) Conformance, and stores all standard and private data elements of received SOP Instances.

Successfully received SOP Instances may be accessed via the EchoPAC PC user interface. SOP Instances are stored until manually deleted by the user.

Following are the status codes the Application may send back to the SCU Equipment after performing the requested **Storage**:

Service Status	Status Code	Further Meaning	Status Code Explanation	Related Fields Sent Back to the SCU
Failure	A700	Refused: Out of resources	Disk Full  Disk File System Error	(0000,0902)
	A900	Error: Data Set does not match SOP Class	Affected SOP Class UID (0000,0002) is not the same as the IOD SOP Class UID (0008,0016)	(0000,0901) (0000,0902)

	C000	Error: Cannot Understand	Affected SOP Instance UID (0000,1000) is not the same as the IOD SOP Instance UID (0008,0018)	(0000,0901) (0000,0902)
Success	0000			None

**2.3.1.3.4.3 Presentation Context Acceptance Criterion**

The EchoPAC PC AE will accept the Presentation Contexts for the SOP Classes associated with Image File Storage only if a minimum amount of storage space is available on the online disk. If such space is not available, the EchoPAC PC AE will return a Result/Reason "No-reason (provider rejection)" for all Presentation Contexts proposed for Storage SOP Classes.

**2.3.1.3.4.4 Transfer Syntax Selection Policies**

Within each Presentation Context, the EchoPAC PC AE will accept the first proposed transfer syntax that it also supports for that Abstract Syntax.

**2.4 COMMUNICATION PROFILES**

**2.4.1 Supported Communication Stacks (PS 3.8, PS 3.9)**

DICOM Upper Layer (PS 3.8) is supported using TCP/IP.

**2.4.2 TCP/IP Stack**

The TCP/IP stack is inherited from the product's operating system. Please refer to product documentation for more information.

**2.4.2.1 API**

Not applicable to this product.

**2.4.3 Additional Protocols**

The ability to enable and use DHCP as a client is inherited from the product's operating system. Please refer to product documentation for more information.

The ability to enable and use DNS as a client is inherited from the product's operating system. Please refer to product documentation for more information. Note: The product does not support configuration of the SCP only by hostname. The SCP must be specified by AE Title, IP address (together with an associated name) and port number (see 2.6).

**2.4.4 IPv4 and IPv6 Support**

The product does only support IPv4.

**2.5 EXTENSIONS / SPECIALIZATIONS / PRIVATIZATIONS**

If so configured, the product will send ultrasound raw data information in private data elements designated by the Private Creator element:

Element Name	Tag	VR	VM	Description
Private Creator	7FE1,00xx	LO	1	GEMS_Ultrasound_MovieGroup_001

This means that all private tags starting with 7FE1,xx will belong to the GEMS\_Ultrasound\_MovieGroup\_001.

If so configured, the product will send preview image in private data elements designated by the Private Creator element:

Element Name	Tag	VR	VM	Description
Private Creator	6003,00xx	LO	1	GEMS_Ultrasound_ImageGroup_001

This means that all private tags starting with 6003,xx will belong to the GEMS\_Ultrasound\_ImageGroup\_001.

If so configured, the product will send exam information in private data elements designated by the Private Creator element:

Element Name	Tag	VR	VM	Description
Private Creator	6005,00xx	LO	1	GEMS_Ultrasound_ExamGroup_001

This means that all private tags starting with 6005,xx will belong to the GEMS\_Ultrasound\_ExamGroup\_001.

## 2.6 CONFIGURATION

### 2.6.1 AE Title/Presentation Address Mapping

The Local AE title is configurable through the Config screen, see below.

The EchoPAC PC AE resolves addresses of other applications and entities using a configurable look-up table. This table is maintained by the system administrator using the EchoPAC PC Configuration user interface.

### 2.6.2 Configurable Parameters

#### Network:

- Local IP address
- Local port number (default 104)
- Local IP netmask
- Local routing table information

#### Local:

- Local AE Title

#### Verification:

- The AE Title, IP address and port number of the SCP
- Max retries, Retry interval, Timeout

#### Storage:

- The AE Title, IP address and port number of the SCP

- Max retries, Retry interval, Timeout
- Enable/disable raw data
- Frame rate reduction
- Enable/disable multi-frame
- Compression selections
- Color support
- Association strategies: one association per image or one association per exam
- Enable/disable results (SR).
- Enable/disable private data elements in results (SR).
- Enable/disable “Signed Doppler Velocities” in results (SR).
- Enable/disable “Use older SR version”.
- Selection of SR version (when “Use older SR version” is enabled).

**Storage Commitment:**

- The AE Title, IP address and port number of the SCP
- Max retries, Retry interval, Timeout

**Print:**

- The AE Title, IP address and port number of the SCP
- Max retries, Retry interval, Timeout
- Configuration for each job according to attribute description in Section 10 of this document.

**Query/Retrieve:**

- The AE Title, IP address and port number of the SCP
- Max retries, Retry interval, Timeout
- Disabling/enabling and setting constant values for query fields
- Maximum number of downloaded entries

**Remote Storage:**

The following fields are configurable for this AE (local):

- Local Listening TCP/IP Port Number
- Local AE Title

The following fields are configurable for every remote DICOM AE:

- Remote AE Title
- Remote IP Address
- Listening TCP/IP Port Number

The following fields are configurable:

- Association Establishment Timer
- Store, Find, Move, Timers
- Inactivity Timers
- Maximum Length PDU
- Number of simultaneous associations

Note: All configurations must be performed by a GE Field Engineer.



## **2.7 SUPPORT OF EXTENDED CHARACTER SETS**

EchoPAC PC will support the ISO\_IR 100 (ISO 8859-1:1987 Latin alphabet N 1. supplementary set) as extended character set. Any incoming SOP instance that is encoded using another extended character set will not be displayed.

For Remote Storage only: No extended character sets supported.

## **2.8 CODES AND CONTROLLED TERMINOLOGY**

### **2.8.1 Fixed Coded Terminology**

The product uses the fixed (non-configurable, non-extensible) coded terminology in SR Document attributes, as described in Section 7 SR INFORMATION OBJECT IMPLEMENTATION.

## **2.9 SECURITY PROFILES**

The product does not conform to any defined DICOM Security Profiles.

It is assumed that the product is used within a secured environment. It is assumed that a secured environment includes at a minimum:

1. Firewall or router protections to ensure that only approved external hosts have network access to the product.
2. Firewall or router protections to ensure that the product only has network access to approved external hosts and services.
3. Any communications with external hosts and services outside the locally secured environment use appropriate secure network channels (such as a Virtual Private Network(VPN))

### 3. MEDIA STORAGE CONFORMANCE STATEMENT

#### 3.1 INTRODUCTION

This section of the conformance statement (CS) specifies the EchoPAC PC compliance to DICOM Media Interchange. It details the DICOM Media Storage Application Profiles and roles, which are supported by this product.

EchoPAC PC is able to export images and results to DICOM media, browse DICOM media or read images from DICOM media.

#### 3.2 IMPLEMENTATION MODEL

##### 3.2.1 Application Data Flow Diagram

The Basic and Specific Application models for this device are shown in the following Illustration:

ILLUSTRATION 3-1  
SPECIFIC AE APPLICATION MODEL

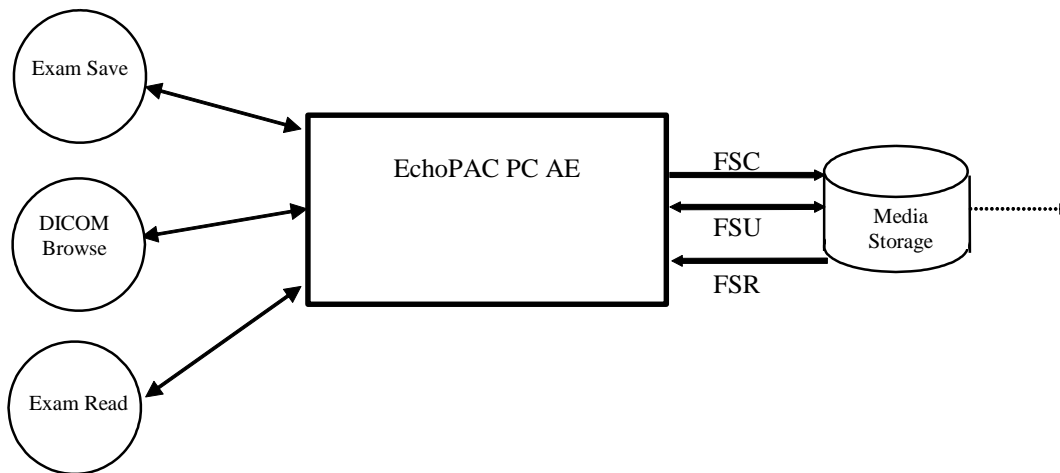

EchoPAC PC can initialize Media by acting as an FSC to create a new DICOM File-set on Media as stated in 3.3.1. The SOP instances written to media must be one of the instances supported by EchoPAC PC. A pre-existing File-set will be updated with the information in DICOM files copied to media.

##### 3.2.2 Functional Definition of AE's

EchoPAC PC can perform these functions:

- Create a new DICOM File-set on media

- Update DICOM File-set by adding new SOP instances to the File-set
- Read information and images from the existing File-set

**3.2.3 Sequencing Requirements**

None applicable

**3.2.4 File Meta Information Options (See PS3.10)**

The File Meta-Information for this implementation is:

<b>File Meta-Information Version</b>	<b>1</b>
<b>EchoPAC PC Implementation UID</b>	<b>1.2.840.113619.6.118</b>
<b>Implementation Version Name</b>	<b>EchoPAC_PC_12</b>

Note: The Implementation Version Name may change in the future without modification of this document.

**3.3 AE SPECIFICATIONS**

**3.3.1 EchoPAC PC AE Specification**

The EchoPAC PC Application Entity provides standard conformance to DICOM Interchange Option of the Media Storage Service Class. The Application Profiles and roles are listed below, the standard profiles are augmented with Secondary Capture images and SRs. Note that in one case (see 4.5.7.1 US Region Calibration Module), the multi-frame image will be sent without region calibration (i.e. AUG-US-ID-MF-XXX).

<b>Supported Application Profile</b>	<b>Real World Activity</b>	<b>Role</b>	<b>Description</b>
AUG-US-SC-SF-MOD128, AUG-US-SC-SF-MOD230, AUG-US-SC-SF-MOD540, AUG-US-SC-SF-MOD640, AUG-US-SC-SF-MOD650, AUG-US-SC-SF-MOD12, AUG-US-SC-SF-MOD23, AUG-US-SC-SF-MOD23-90, AUG-US-SC-MF-MOD128, AUG-US-SC-MF-MOD230, AUG-US-SC-MF-MOD540, AUG-US-SC-MF-MOD640, AUG-US-SC-MF-MOD650, AUG-US-SC-MF-MOD12, AUG-US-SC-MF-MOD23, AUG-US-SC-MF-MOD23-90	Exam save	FSR/ FSC/ FSU	Interchange
	Browse	FSR	Interchange
	Exam Read	FSR	Interchange
AUG-US-SC-SF-CDR, AUG-US-SC-MF-CDR, AUG-US-SC-SF-DVD, AUG-US-SC-MF-DVD	Exam save	FSR/FSC	Interchange
	Browse	FSR	Interchange
	Exam Read	FSR	Interchange

**3.3.1.1 File Meta Information for the EchoPAC PC Application Entity**

The Source Application Entity is set from the EchoPAC PC local AE title. The local AE is configurable.

Following are the default value set in the File Meta Information for this AE Title:

<b>Source Application Entity Title</b>	<b>EchoPAC_PC_12</b>
--	----------------------

**3.3.1.2 Real-World Activities for the EchoPAC PC Application Entity**

**3.3.1.2.1 Real-World Activity “Exam save”**

“Exam save” saves a DICOM SOP instance to media and updates DICOM File Set.

**3.3.1.2.1.1 Media Storage Application Profile for the Real-World Activity “Exam save”:**

For the list of Application Profiles that invoke this AE for “Exam save” Real-World Activity, see the Table in Section 3.3.1 “EchoPAC PC AE Specification” where the table describing the profiles and real-world activities is defined.

**3.3.1.2.1.1.1 Options**

Following are the SOP Classes supported by the Real-World Activity “Exam save”:

<b>Information Object Definition</b>	<b>SOP Class UID</b>	<b>Transfer Syntax</b>	<b>Transfer Syntax UID</b>
DICOM Media Storage Directory	1.2.840.10008.1.3.10	Explicit VR Little Endian	1.2.840.10008.1.2.1
Ultrasound Multi-frame Image Storage	1.2.840.10008.5.1.4.1.1.3.1	Explicit VR Little Endian	1.2.840.10008.1.2.1
		Run Length Encoding, RLE	1.2.840.10008.1.2.5
		JPEG Baseline	1.2.840.10008.1.2.4.50
Ultrasound Image Storage	1.2.840.10008.5.1.4.1.1.6.1	Explicit VR Little Endian	1.2.840.10008.1.2.1
		Run Length Encoding, RLE	1.2.840.10008.1.2.5
		JPEG Baseline	1.2.840.10008.1.2.4.50
Secondary Capture Image Storage	1.2.840.10008.5.1.4.1.1.7	Explicit VR Little Endian	1.2.840.10008.1.2.1
		Run Length Encoding, RLE	1.2.840.10008.1.2.5
		JPEG Baseline	1.2.840.10008.1.2.4.50
Comprehensive Structured Report	1.2.840.10008.5.1.4.1.1.88.33	Explicit VR Little Endian	1.2.840.10008.1.2.1

**3.3.1.2.2 Real-World Activity “DICOM Browse”**

DICOM Browse is activated when the user searches for an exam in Search screen.

**3.3.1.2.2.1 Media Storage Application Profile for the Real-World Activity “DICOM Browse”**

For the list of Application Profiles that invoke this AE for Image Read Real-World Activity, see the Table in Section 3.2.1 “EchoPAC PC AE Specification”.

**3.3.1.2.2.1.1 Options**

Following are the SOP Classes supported by the Real-World Activity DICOM Browse:

<b>Information Object Definition</b>	<b>SOP Class UID</b>	<b>Transfer Syntax</b>	<b>Transfer Syntax UID</b>
DICOM Media Storage Directory	1.2.840.10008.1.3.10	Explicit VR Little Endian	1.2.840.10008.1.2.1
Ultrasound Multi-frame Image Storage	1.2.840.10008.5.1.4.1.1.3.1	Explicit VR Little Endian	1.2.840.10008.1.2.1
		Implicit VR Little Endian	1.2.840.10008.1.2
		Run Length Encoding, RLE	1.2.840.10008.1.2.5
		JPEG Baseline	1.2.840.10008.1.2.4.50
Ultrasound Multi-frame Image Storage(retired)	1.2.840.10008.5.1.4.1.1.3	Explicit VR Little Endian	1.2.840.10008.1.2.1
		Implicit VR Little Endian	1.2.840.10008.1.2
		Run Length Encoding, RLE	1.2.840.10008.1.2.5
		JPEG Baseline	1.2.840.10008.1.2.4.50
Ultrasound Image Storage	1.2.840.10008.5.1.4.1.1.6.1	Explicit VR Little Endian	1.2.840.10008.1.2.1
		Implicit VR Little Endian	1.2.840.10008.1.2
		Run Length Encoding, RLE	1.2.840.10008.1.2.5
		JPEG Baseline	1.2.840.10008.1.2.4.50
Ultrasound Image Storage (retired)	1.2.840.10008.5.1.4.1.1.6	Explicit VR Little Endian	1.2.840.10008.1.2.1
		Implicit VR Little Endian	1.2.840.10008.1.2
		Run Length Encoding, RLE	1.2.840.10008.1.2.5

		JPEG Baseline	1.2.840.10008.1.2.4.50
Secondary Capture Image Storage	1.2.840.10008.5.1.4.1.1.7	Explicit VR Little Endian	1.2.840.10008.1.2.1
		Implicit VR Little Endian	1.2.840.10008.1.2
		Run Length Encoding, RLE	1.2.840.10008.1.2.5
		JPEG Baseline	1.2.840.10008.1.2.4.50

Note: As shown in the table Implicit VR Little Endian Transfer Syntax is supported in addition to Transfer Syntaxes defined in Application Profiles.

**3.3.1.2.3 Real-World Activity “Exam read“**

“Exam read” reads and displays a DICOM SOP instance from media.

**3.3.1.2.3.1 Media Storage Application Profile for the Real-World Activity “Exam read “**

For the list of Application Profiles that invoke this AE for Exam read Real-World Activity, see the Table in Section 3.2.1 “EchoPAC PC AE Specification”.

**3.3.1.2.3.1.1 Options**

Following are the SOP Classes supported by the Exam read Real-World Activity:

<b>Information Object Definition</b>	<b>SOP Class UID</b>	<b>Transfer Syntax</b>	<b>Transfer Syntax UID</b>
DICOM Media Storage Directory	1.2.840.10008.1.3.10	Explicit VR Little Endian	1.2.840.10008.1.2.1
Ultrasound Multi-frame Image Storage	1.2.840.10008.5.1.4.1.1.3.1	Explicit VR Little Endian	1.2.840.10008.1.2.1
		Implicit VR Little Endian	1.2.840.10008.1.2
		Run Length Encoding, RLE	1.2.840.10008.1.2.5
		JPEG Baseline	1.2.840.10008.1.2.4.50
Ultrasound Multi-frame Image Storage(retired)	1.2.840.10008.5.1.4.1.1.3	Explicit VR Little Endian	1.2.840.10008.1.2.1
		Implicit VR Little Endian	1.2.840.10008.1.2
		Run Length Encoding, RLE	1.2.840.10008.1.2.5
		JPEG Baseline	1.2.840.10008.1.2.4.50
Ultrasound Image Storage	1.2.840.10008.5.1.4.1.1.6.1	Explicit VR Little Endian	1.2.840.10008.1.2.1

		Implicit VR Little Endian	1.2.840.10008.1.2
		Run Length Encoding, RLE	1.2.840.10008.1.2.5
		JPEG Baseline	1.2.840.10008.1.2.4.5 0
Ultrasound Image Storage (retired)	1.2.840.10008.5.1.4.1.1.6	Explicit VR Little Endian	1.2.840.10008.1.2.1
		Implicit VR Little Endian	1.2.840.10008.1.2
		Run Length Encoding, RLE	1.2.840.10008.1.2.5
		JPEG Baseline	1.2.840.10008.1.2.4.5 0
Secondary Capture Image Storage	1.2.840.10008.5.1.4.1.1.7	Explicit VR Little Endian	1.2.840.10008.1.2.1
		Implicit VR Little Endian	1.2.840.10008.1.2
		Run Length Encoding, RLE	1.2.840.10008.1.2.5
		JPEG Baseline	1.2.840.10008.1.2.4.5 0

Note: As shown in the table Implicit VR Little Endian Transfer Syntax is supported in addition to Transfer Syntaxes defined in Application Profiles.

**3.4 AUGMENTED AND PRIVATE APPLICATION PROFILES**

EchoPAC PC creates Secondary Capture Image and SR Objects in addition to the objects defined in the application profiles.

**3.5 EXTENSIONS, SPECIALIZATIONS, PRIVATIZATIONS OF SOP CLASSES AND TRANSFER SYNTAXES**

If so configured, the product will send ultrasound raw data information in private data elements designated by the Private Creator element:

Element Name	Tag	VR	VM	Description
Private Creator	7FE1,00xx	LO	1	GEMS_Ultrasound_MovieGroup_001

This means that all private tags starting with 7FE1,xx will belong to the GEMS\_Ultrasound\_MovieGroup\_001.

If so configured, the product will send preview image in private data elements designated by the Private Creator element:

Element Name	Tag	VR	VM	Description
Private Creator	6003,00xx	LO	1	GEMS_Ultrasound_ImageGroup_001

This means that all private tags starting with 6003,xx will belong to the GEMS\_Ultrasound\_ImageGroup\_001.

If so configured, the product will send exam information in private data elements designated by the Private Creator element:

Element Name	Tag	VR	VM	Description
Private Creator	6005,00xx	LO	1	GEMS_Ultrasound_ExamGroup_001

This means that all private tags starting with 6005,xx will belong to the GEMS\_Ultrasound\_ExamGroup\_001.

DICOMDIR has also been extended with Standard Extended elements.

### 3.6 CONFIGURATION

The following parameters are configurable:

- Location of DICOMDIR
- Read or Read/Write
- Enable/disable raw data
- Frame rate reduction
- Enable/disable multi-frame
- Compression selections
- Enable/disable results (SR).
- Enable/disable private data elements in results (SR).
- Enable/disable “Signed Doppler Velocities” in results (SR).
- Enable/disable “Use older SR version”.
- Selection of SR version (when “Use older SR version” is enabled).

### 3.7 SUPPORT OF EXTENDED CHARACTER SETS

EchoPAC PC will support only the ISO\_IR 100 (ISO 8859-1:1987 Latin alphabet N 1. supplementary set) as extended character sets. Any incoming SOP instance that is encoded using another extended character set will not be read.



## **4. ULTRASOUND (US) INFORMATION OBJECT IMPLEMENTATION**

### **4.1 INTRODUCTION**

This section specifies the use of the DICOM US Image IOD to represent the information included in US images produced by this implementation. Corresponding attributes are conveyed using the module construct. The contents of this section are:

4.2 - IOD Implementation

4.3 - IOD Entity-Relationship Model

4.4 - IOD Module Table

4.5 - IOD Module Definition

In this section, supported means that tag is sent with value.

### **4.2 US IOD IMPLEMENTATION**

This section defines the implementation of US image information object.

### **4.3 US ENTITY-RELATIONSHIP MODEL**

The Entity-Relationship diagram for the US Image interoperability schema is shown in Illustration 4.3-1. In this figure, the following diagrammatic convention is established to represent the information organization:

- each entity is represented by a rectangular box
- each relationship is represented by a diamond shaped box.
- the fact that a relationship exists between two entities is depicted by lines connecting the corresponding entity boxes to the relationship boxes.

The relationships are fully defined with the maximum number of possible entities in the relationship shown. In other words, the relationship between Series and Image can have up to n Images per Series, but the Patient to Study relationship has 1 Patient for each Study (a Patient can have more than one Study on the system, however each Study will contain all of the information pertaining to that Patient).

ILLUSTRATION 4.3-1  
 US IMAGE ENTITY RELATIONSHIP DIAGRAM

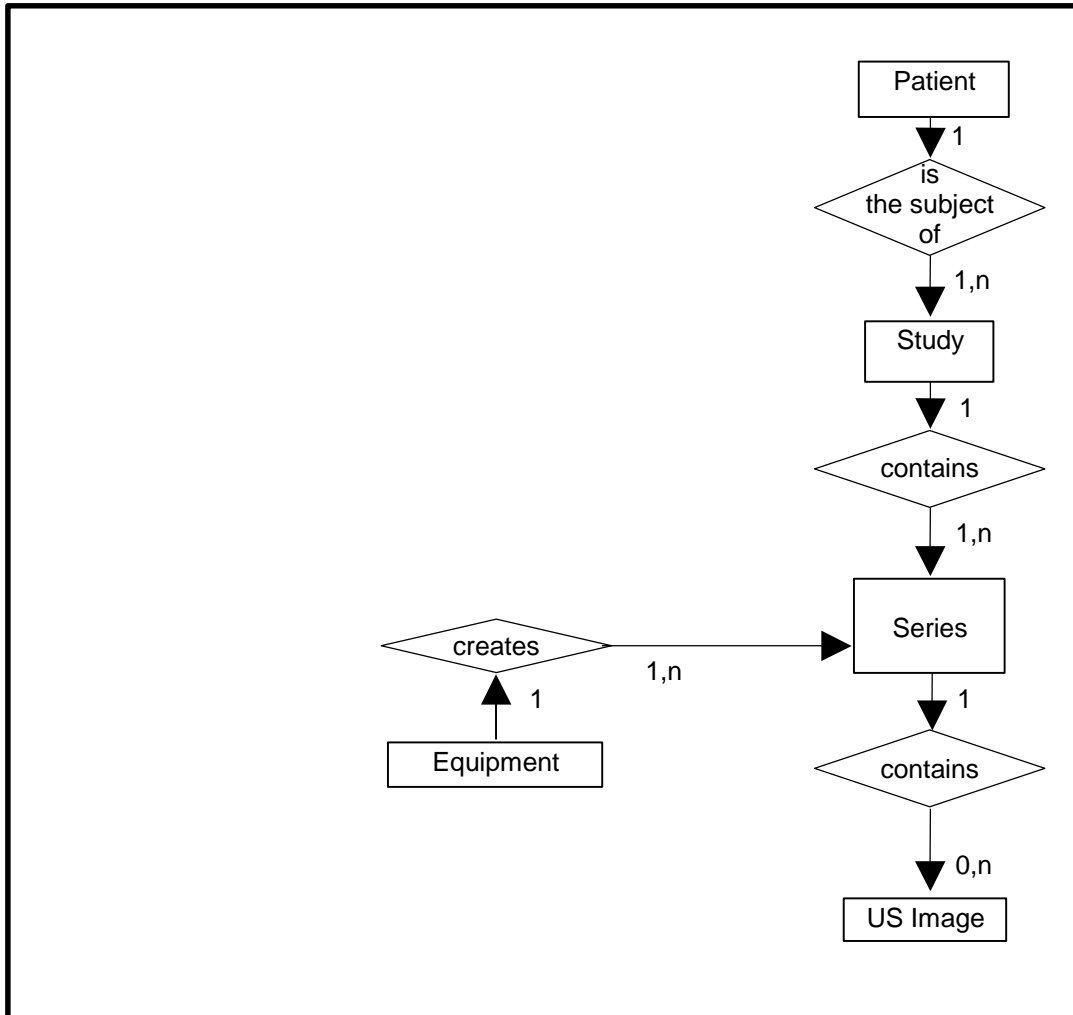

4.3.1 Entity Descriptions

Please refer to DICOM Standard Part 3 (Information Object Definitions) for a description of each of the entities contained within the US Information Object.

4.3.2 EchoPAC PC Mapping of DICOM Entities

TABLE 4.3-1  
 MAPPING OF DICOM ENTITIES TO ECHOPAC PC ENTITIES

DICOM	EchoPAC PC Entity
Patient	Patient
Study	Exam
Series	Exam
Image	Image
Curve	Not used

**4.4 IOD MODULE TABLE**

Within an entity of the DICOM US IOD, attributes are grouped into related set of attributes. A set of related attributes is termed a module. A module facilitates the understanding of the semantics concerning the attributes and how the attributes are related with each other. A module grouping does not infer any encoding of information into data sets.

Table 4.4-1 identifies the defined modules within the entities, which comprise the DICOM US IOD. Modules are identified by Module Name.

See DICOM Part 3 for a complete definition of the entities, modules, and attributes.

Only the single frame US Image IOD is described here.

**TABLE 4.4-1**  
**US IMAGE IOD MODULES**

<b>Entity Name</b>	<b>Module Name</b>	<b>Reference</b>
Patient	Patient	4.5.1.1
Study	General Study	4.5.2.1
	Patient Study	4.5.2.2
Series	General Series	4.5.3.1
Frame of Reference	Frame of Reference	Not used
	US Frame of Reference	Not used
Equipment	General Equipment	4.5.4.1
Image	General Image	4.5.5.1
	Image Pixel	4.5.5.2
	Contrast/Bolus	4.5.5.3
	Palette Color Lookup Table	4.5.5.4
	US Region Calibration	4.5.7.1
	US Image	4.5.7.2
	Overlay Plane	Not used
	VOI LUT	4.5.5.5
SOP Common	4.5.6.1	
Curve	Not used	

**4.5 INFORMATION MODULE DEFINITIONS**

Please refer to DICOM Standard Part 3 (Information Object Definitions) for a description of each of the entities and modules contained within the US Information Object.

The following modules are included to convey Enumerated Values, Defined Terms, and Optional Attributes supported. Type 1 & Type 2 Attributes are also included for completeness and to define what values they may take and where these values are obtained. It should be noted that they are the same ones as defined in the DICOM Standard Part 3 (Information Object Definitions).

**4.5.1 Common Patient Entity Modules**

**4.5.1.1 Patient Module**

This section specifies the Attributes of the Patient that describe and identify the Patient who is the subject of a diagnostic Study. This Module contains Attributes of the patient that are needed for diagnostic interpretation of the Image and are common for all studies performed on the patient.

**TABLE 4.5-1**  
**PATIENT MODULE ATTRIBUTES**

Attribute Name	Tag	Type	Attribute Description
Patient's Name	(0010,0010)	2	May be entered from User Interface.
Patient ID	(0010,0020)	2	May be entered from User Interface.
Patient's Birth Date	(0010,0030)	2	May be entered from User Interface.
Patient's Sex	(0010,0040)	2	May be entered from User Interface.
Referenced Patient Sequence	(0008,1120)	3	Not used
>Referenced SOP Class UID	(0008,1150)	1C	Not used
>Referenced SOP Instance UID	(0008,1155)	1C	Not used
Patient's Birth Time	(0010,0032)	3	Not used
Other Patient Ids	(0010,1000)	3	May be entered from User Interface.
Other Patient Names	(0010,1001)	3	Not used
Ethnic Group	(0010,2160)	3	Not used
Patient Comments	(0010,4000)	3	Not used

**4.5.2 Common Study Entity Modules**

The following Study IE Modules are common to all Composite Image IODs, which reference the Study IE. These modules contain Attributes of the patient and study that are needed for diagnostic interpretation of the image.

**4.5.2.1 General Study Module**

This section specifies the attributes that describe and identify the Study performed upon the Patient.

**TABLE 4.5-2**  
**GENERAL STUDY MODULE ATTRIBUTES**

Attribute Name	Tag	Type	Attribute Description
Study Instance UID	(0020,000D)	1	Uniquely generated by the equipment.
Study Date	(0008,0020)	2	Is set to examination date
Study Time	(0008,0030)	2	Is set to examination time
Referring Physician's Name	(0008,0090)	2	May be entered from User Interface.

Study ID	(0020,0010)	2	May be entered from User Interface.
Accession Number	(0008,0050)	2	May be entered from User Interface.
Study Description	(0008,1030)	3	May be entered from User Interface.
Physician(s) of Record	(0008,1048)	3	Not used
Name of Physician(s) Reading Study	(0008,1060)	3	Not used
Referenced Study Sequence	(0008,1110)	3	Not used
>Referenced SOP Class UID	(0008,1150)	1C	Not used
>Referenced SOP Instance UID	(0008,1155)	1C	Not used

**4.5.2.2 Patient Study Module**

This section defines attributes that provide information about the Patient at the time that the Study was performed.

**TABLE 4.5-3**  
**PATIENT STUDY MODULE ATTRIBUTES**

<b>Attribute Name</b>	<b>Tag</b>	<b>Type</b>	<b>Attribute Description</b>
Admitting Diagnoses Description	(0008,1080)	3	Not used
Patient's Age	(0010,1010)	3	Not used
Patient's Size	(0010,1020)	3	May be entered from User Interface.
Patient's Weight	(0010,1030)	3	May be entered from User Interface.
Occupation	(0010,2180)	3	Not used
Additional Patient's History	(0010,21B0)	3	May be entered from User Interface (in Referral reason).
Admission ID	(0038,0010)	3	Not used
Issuer of Admission ID	(0038,0011)	3	Not used

**4.5.3 Common Series Entity Modules**

The following Series IE Modules are common to all Composite Image IODs, which reference the Series IE.

**4.5.3.1 General Series Module**

This section specifies the attributes that identify and describe general information about the Series within a Study.

**TABLE 4.5-4**  
**GENERAL SERIES MODULE ATTRIBUTES**

<b>Attribute Name</b>	<b>Tag</b>	<b>Type</b>	<b>Attribute Description</b>
Modality	(0008,0060)	1	Defined Term "US" used.
Series Instance UID	(0020,000E)	1	Uniquely generated by the equipment
Series Number	(0020,0011)	2	Internal number which is incremented for each new series within a study.
Laterality	(0020,0060)	2C	Not used
Series Date	(0008,0021)	3	Is set to Series date
Series Time	(0008,0031)	3	Is set to Series time
Performing Physicians' Name	(0008,1050)	3	May be entered from User Interface.
Protocol Name	(0018,1030)	3	Sent if image is acquired in a stress test.
Series Description	(0008,103E)	3	May be entered from User Interface (in Diagnosis).
Operator's Name	(0008,1070)	3	May be entered from User Interface. Default is login id.
Referenced Performed Procedure Step Sequence	(0008,1111)	3	Not used
>Referenced SOP Class UID	(0008,1150)	1C	Not used
>Referenced SOP Instance UID	(0008,1155)	1C	Not used
Body Part Examined	(0018,0015)	3	Not used
Patient Position	(0018,5100)	2C	Not used
Smallest Pixel Value in Series	(0028,0108)	3	Not used
Largest Pixel Value in Series	(0028,0109)	3	Not used
Request Attributes Sequence	(0040,0275)	3	Not used
>Requested Procedure ID	(0040,1001)	1C	Not used
>Scheduled Procedure Step ID	(0040,0009)	1C	Not used
>Scheduled Procedure Step Description	(0040,0007)	3	Not used
>Scheduled Protocol Code Sequence	(0040,0008)	3	Not used
>>Include 'Code Sequence Macro'			
Performed Procedure Step ID	(0040,0253)	3	Not used
Performed Procedure Step Start Date	(0040,0244)	3	Not used
Performed Procedure Step Start Time	(0040,0245)	3	Not used
Performed Procedure Step Description	(0040,0254)	3	Not used
Performed Protocol Code Sequence	(0040,0260)	3	Taken from selected protocol.
>Include 'Code Sequence Macro'			

**4.5.4 Common Equipment Entity Modules**

The following Equipment IE Module is common to all Composite Image IODs, which reference the Equipment IE.

**4.5.4.1 General Equipment Module**

This section specifies the attributes that identify and describe the piece of equipment, which produced a Series of Images.

**TABLE 4.5-5**  
**GENERAL EQUIPMENT MODULE ATTRIBUTES**

Attribute Name	Tag	Type	Attribute Description
Manufacturer	(0008,0070)	2	Is set to “GE Vingmed Ultrasound”
Institution Name	(0008,0080)	3	Is set to configured Institution Name.
Institution Address	(0008,0081)	3	Not used
Station Name	(0008,1010)	3	Is set to configured Station Name.
Institutional Department Name	(0008,1040)	3	May be entered from User Interface. Default is configured Department name.
Manufacturer’s Model Name	(0008,1090)	3	Is set to “EchoPAC PC” or “EchoPAC PC SW-Only”.
Device Serial Number	(0018,1000)	3	Not used
Software Versions	(0018,1020)	3	Is set to EchoPAC PC software version
Spatial Resolution	(0018,1050)	3	Not used
Date of Last Calibration	(0018,1200)	3	Not used
Time of Last Calibration	(0018,1201)	3	Not used
Pixel Padding Value	(0028,0120)	3	Not used

**4.5.5 Common Image Entity Modules**

The following Image IE Modules are common to all Composite Image IODs, which reference the Image IE.

**4.5.5.1 General Image Module**

This section specifies the attributes that identify and describe an image within a particular series.

**TABLE 4.5-6**  
**GENERAL IMAGE MODULE ATTRIBUTES**

Attribute Name	Tag	Type	Attribute Description
Instance Number	(0020,0013)	2	Internal value which is incremented for each image within a series
Patient Orientation	(0020,0020)	2C	Sent with empty value.
Content Date	(0008,0023)	2C	Set from Image date
Content Time	(0008,0033)	2C	Set from Image time

Attribute Name	Tag	Type	Attribute Description
Image Type	(0008,0008)	3	The first two values contain "ORIGINAL\PRIMARY" or "DERIVED\PRIMARY". Value 3 is always empty. Value 4 is a description of the mode. Values beyond this may be used for private data.
Acquisition Number	(0020,0012)	3	Not used
Acquisition Date	(0008,0022)	3	Not used
Acquisition Time	(0008,0032)	3	Not used
Acquisition Datetime	(0008,002A)	3	Supported
Referenced Image Sequence	(0008,1140)	3	May be used for related images
>Referenced SOP Class UID	(0008,1150)	1C	
>Referenced SOP Instance UID	(0008,1155)	1C	
>Referenced Frame Number	(0008,1160)	3	Not used
Derivation Description	(0008,2111)	3	May contain additional derivation information if Image Type is DERIVED.
Source Image Sequence	(0008,2112)	3	May be used for source images
>Referenced SOP Class UID	(0008,1150)	1C	
>Referenced SOP Instance UID	(0008,1155)	1C	
>Referenced Frame Number	(0008,1160)	3	Not used
Images in Acquisition	(0020,1002)	3	Not used
Image Comments	(0020,4000)	3	May be used for description of the image
Quality Control Image	(0028,0300)	3	Not used
Burned In Annotation	(0028,0301)	3	Used if identifying info is included in the image
Lossy Image Compression	(0028,2110)	3	Set to 01 if image is lossy compressed.
Lossy Image Compression Ratio	(0028,2112)	3	Used if lossy compressed.

**4.5.5.2 Image Pixel Module**

This section specified the attributes that describe the pixel data of the image.

**TABLE 4.5-7**  
**IMAGE PIXEL MODULE ATTRIBUTES**

Attribute Name	Tag	Type	Attribute Description
Samples per Pixel	(0028,0002)	1	Value of '1' if Photometric Interpretation element value has value "MONOCHROME2" or "PALETTE COLOR" (only for read) Value of '3' when Photometric Interpretation element value has value "RGB", "YBR_FULL" or "YBR_FULL_422"



Attribute Name	Tag	Type	Attribute Description
Photometric Interpretation	(0028,0004)	1	Defined Values used: "MONOCHROME2", "RGB", "YBR_FULL", "YBR_FULL_422" or "PALETTE COLOR" (only for read)
Rows	(0028,0010)	1	Value depends on scanning mode and configuration setup
Columns	(0028,0011)	1	Value depends on scanning mode and configuration setup.
Bits Allocated	(0028,0100)	1	Value always = 0008H.
Bits Stored	(0028,0101)	1	Value always = 0008H.
High Bit	(0028,0102)	1	Value always = 0007H.
Pixel Representation	(0028,0103)	1	Defined Value '0' - unsigned integer.
Pixel Data	(7FE0,0010)	1	Pixel Data of image.
Planar Configuration	(0028,0006)	1C	Enumerated value 0000H, color-by-pixel, if Photometric Interpretation element value has value 'RGB' (uncompressed) or if image is JPEG compressed.  Enumerated value 0001H, color-by-plane if image is RLE compressed.
Pixel Aspect Ratio	(0028,0034)	1C	Not used
Smallest Image Pixel Value	(0028,0106)	3	Not used
Largest Image Pixel Value	(0028,0107)	3	Not used
Red Palette Color Lookup Table Descriptor	(0028,1101)	1C	Only used when reading Palette images.
Green Palette Color Lookup Table Descriptor	(0028,1102)	1C	Only used when reading Palette images.
Blue Palette Color Lookup Table Descriptor	(0028,1103)	1C	Only used when reading Palette images.
Red Palette Color Lookup Table Data	(0028,1201)	1C	Only used when reading Palette images.
Green Palette Color Lookup Table Data	(0028,1202)	1C	Only used when reading Palette images.
Blue Palette Color Lookup Table Data	(0028,1203)	1C	Only used when reading Palette images.

#### 4.5.5.3 Contrast/Bolus Module

This section specifies the attributes that describe the contrast /bolus used in the acquisition of the Image.

TABLE 4.5-8  
CONTRAST/BOLUS MODULE ATTRIBUTES

Attribute Name	Tag	Type	Attribute Description
Contrast/Bolus Agent	(0018,0010)	2	May be entered from User Interface.
Contrast/Bolus Agent Sequence	(0018,0012)	3	Not used
>Include 'Code Sequence Macro'			
Contrast/Bolus Route	(0018,1040)	3	Not used
Contrast/Bolus Administration Route Sequence	(0018,0014)	3	Not used
>Include 'Code Sequence Macro'			

Attribute Name	Tag	Type	Attribute Description
>Additional Drug Sequence	(0018,002A)	3	Not used
>>Include 'Code Sequence Macro'			
Contrast/Bolus Volume	(0018,1041)	3	Not used
Contrast/Bolus Start Time	(0018,1042)	3	Not used
Contrast/Bolus Stop Time	(0018,1043)	3	Not used
Contrast/Bolus Total Dose	(0018,1044)	3	Not used
Contrast Flow Rate(s)	(0018,1046)	3	Not used
Contrast Flow Duration(s)	(0018,1047)	3	Not used
Contrast/Bolus Ingredient	(0018,1048)	3	Not used
Contrast/Bolus Ingredient Concentration	(0018,1049)	3	Not used

**4.5.5.4 Palette Color Lookup Table Module**

This section specifies the attributes that describe the Lookup table data for images with Palette Color photometric interpretation.

**TABLE 4.5-9**  
**PALETTE COLOR LOOKUP MODULE**

Attribute Name	Tag	Type	Attribute Description
Red Palette Color Lookup Table Descriptor	(0028,1101)	1C	Only used when reading Palette images.
Green Palette Color Lookup Table Descriptor	(0028,1102)	1C	Only used when reading Palette images.
Blue Palette Color Lookup Table Descriptor	(0028,1103)	1C	Only used when reading Palette images.
Palette Color Lookup Table UID	(0028,1199)	3	Not used
Red Palette Color Lookup Table Data	(0028,1201)	1C	Only used when reading Palette images.
Green Palette Color Lookup Table Data	(0028,1202)	1C	Only used when reading Palette images.
Blue Palette Color Lookup Table Data	(0028,1203)	1C	Only used when reading Palette images.
Segmented Red Palette Color Lookup Table Data	(0028,1221)	1C	Not used
Segmented Green Palette Color Lookup Table Data	(0028,1222)	1C	Not used
Segmented Red Palette Color Lookup Table Data	(0028,1223)	1C	Not used

**4.5.5.5 VOI LUT Module**

This section specifies the attributes that identify and describe the VOI LUT Module

**TABLE 4.5-10  
VOI LUT MODULE ATTRIBUTES**

Attribute Name	Tag	Type	Attribute Description
VOI LUT Sequence	(0028,3010)	3	Not used
>LUT Descriptor	(0028,3002)	3	Not used
>LUT Explanation	(0028,3003)	3	Not used
>LUT Data	(0028,3006)	3	Not used
Window Center	(0028,1050)	3	Value set to 127 if Photometric Interpretation has value MONOCHROME2.
Window Width	(0028,1051)	3	Value set to 256 if Photometric Interpretation has value MONOCHROME2.
Window Center & Width Explanation	(0028,1055)	3	Not used

#### 4.5.6 General Modules

The SOP Common Module is mandatory for all DICOM IODs.

##### 4.5.6.1 SOP Common Module

This section defines the attributes that are required for proper functioning and identification of the associated SOP Instances. They do not specify any semantics about the Real-World Object represented by the IOD.

**TABLE 4.5-11  
SOP COMMON MODULE ATTRIBUTES**

Attribute Name	Tag	Type	Attribute Description
SOP Class UID	(0008,0016)	1	Set to “1.2.840.10008.5.1.4.1.1.3.1” “1.2.840.10008.5.1.4.1.1.3” “1.2.840.10008.5.1.4.1.1.6.1” “1.2.840.10008.5.1.4.1.1.6” “1.2.840.10008.5.1.4.1.1.7” or “1.2.840.10008.5.1.4.1.1.88.33”
SOP Instance UID	(0008,0018)	1	Uniquely generated by the equipment
Specific Character Set	(0008,0005)	1C	Set to “ISO_IR 100” if extended characters are used. Image Read: images using other extended character set than “ISO_IR 100” are rejected.
Instance Creation Date	(0008,0012)	3	Not used
Instance Creation Time	(0008,0013)	3	Not used
Instance Creator UID	(0008,0014)	3	Not used
Instance Number	(0020,0013)	3	Not used

#### 4.5.7 US Modules

This Section describes US Series, Equipment, and Image Modules. These Modules contain attributes that are specific to US Image IOD.

4.5.7.1 US Region Calibration Module

US Region Calibration Module is used to describe multiple regions. Note: if a multi-frame image has been acquired with different calibration, the US Region Calibration Module will not be used.

TABLE 4.5-12  
US REGION CALIBRATION MODULE ATTRIBUTES

Attribute Name	Tag	Type	Attribute Description
Sequence of Ultrasound Regions	(0018,6011)	1	Supported.
>Region Location Min $x_0$	(0018,6018)	1	Value is 0
>Region Location Min $y_0$	(0018,601A)	1	Value is 0
>Region Location Max $x_1$	(0018,601C)	1	Value is image width-1.
>Region Location Max $y_1$	(0018,601E)	1	Value is image height-1
>Physical Units X Direction	(0018,6024)	1	Enumerated Values supported: 0003H cm 0004H seconds
>Physical Units Y Direction	(0018,6026)	1	Enumerated Values supported: 0003H cm 0004H seconds 0007H cm/sec
>Physical Delta X	(0018,602C)	1	Varies with scanning mode
>Physical Delta Y	(0018,602E)	1	Varies with scanning mode
>Reference Pixel $x_0$	(0018,6020)	3	Varies with scanning mode
>Reference Pixel $y_0$	(0018,6022)	3	Varies with scanning mode
>Ref. Pixel Physical Value X	(0018,6028)	3	Varies with scanning mode
>Ref. Pixel Physical Value Y	(0018,602A)	3	Varies with scanning mode
>Region Spatial Format	(0018,6012)	1	Supported. The spatial organization of the data within the region.
>Region Data Type	(0018,6014)	1	Supported. The type of data within the region.
>Region Flags	(0018,6016)	1	Bit 0: 0 = Opaque Bit 1: 0 = Not Protected because there may be other regions within the image Bit 2 : 0 = Velocity
>Pixel Component Organization	(0018,6044)	1C	Pixel component calibration data does not exist for any region
>Pixel Component Mask	(0018,6046)	1C	Not used
>Pixel Component Range Start	(0018,6048)	1C	Not used
>Pixel Component Range Stop	(0018,604A)	1C	Not used
>Pixel Component Physical Units	(0018,604C)	1C	Not used
>Pixel Component Data Type	(0018,604E)	1C	Not used
>Number of Table Break Points	(0018,6050)	1C	Not used
>Table of X Break Points	(0018,6052)	1C	Not used
>Table of Y Break Points	(0018,6054)	1C	Not used
>Number of Table Entries	(0018,6056)	1C	Not used
>Table of Pixel Values	(0018,6058)	1C	Not used

Attribute Name	Tag	Type	Attribute Description
>Table of Parameter Values	(0018,605A)	1C	Not used
>Transducer Frequency	(0018,6030)	3	Supported
>Pulse Repetition Frequency	(0018,6032)	3	Supported
>Doppler Correction Angle	(0018,6034)	3	Not used
>Steering Angle	(0018,6036)	3	Not used
>Doppler Sample Volume X Position	(0018,6038)	3	Not used
>Doppler Sample Volume Y Position	(0018,603A)	3	Not used
>TM-Line Position $x_0$	(0018,603C)	3	Not used
>TM-Line Position $y_0$	(0018,603E)	3	Not used
>TM-Line Position $x_1$	(0018,6040)	3	Not used
>TM-Line Position $y_1$	(0018,6042)	3	Not used

4.5.7.2 US Image Module

This section specifies the attributes that describe ultrasound images.

TABLE 4.5-13  
US IMAGE MODULE ATTRIBUTES

Attribute Name	Tag	Type	Attribute Description
Samples Per Pixel	(0028,0002)	1	Value of '1' if Photometric Interpretation element value has value "MONOCHROME2" or "PALETTE COLOR" (only for read) Value of '3' when Photometric Interpretation element value has value "RGB", "YBR_FULL" or "YBR_FULL_422"
Photometric Interpretation	(0028,0004)	1	Defined Values used: "MONOCHROME2", "RGB", "YBR_FULL", "YBR_FULL_422" or "PALETTE COLOR" (only for read).
Bits Allocated	(0028,0100)	1	Value always = 0008H
Bits Stored	(0028,0101)	1	Value always = 0008H
High Bit	(0028,0102)	1	Value always = 0007H
Planar Configuration	(0028,0006)	1	Enumerated value 0000H, color-by-pixel, if Photometric Interpretation element value has value 'RGB' (uncompressed) or if image is JPEG compressed. Enumerated value 0001H, color-by-plane if image is RLE compressed.
Pixel Representation	(0028,0103)	1	Always 0000H = unsigned integer.
Frame Increment Pointer	(0028,0009)	1C	Export: Is set to Frame Time (0018,1063) or Frame Time Vector (0018,1065) if the image is multiframe IOD, Not used if the image is a single frame IOD.
Image Type	(0008,0008)	2	The first two values contain "ORIGINAL\PRIMARY" or "DERIVED\PRIMARY". Value 4 is a description of the mode. Values 5 and 6 may be used for private data.
Lossy Image Compression	(0028,2110)	1C	Set to 01 if image is compressed using JPEG Baseline compression.
Number of Stages	(0008,2124)	2C	Number of stages in stress protocol. Sent if image is acquired in a stress test.
Number of Views in Stage	(0008,212A)	2C	Number of views in this stage of a stress protocol. Sent if image is acquired in a stress test.
R Wave Time Vector	(0018,6060)	3	May be filled in with timing information
Ultrasound Color Data Present	(0028,0014)	3	Supported
Referenced Overlay Sequence	(0008,1130)	3	Not used

Attribute Name	Tag	Type	Attribute Description
>Referenced SOP Class UID	(0008,1150)	1C	Not used
>Referenced SOP Instance UID	(0008,1155)	1C	Not used
Referenced Curve Sequence	(0008,1145)	3	Not used
>Referenced SOP Class UID	(0008,1150)	1C	Not used
>Referenced SOP Instance UID	(0008,1155)	1C	Not used
Stage Name	(0008,2120)	3	Name of stage of stress test. Sent if image is acquired in a stress test. The name is defined in the User Interface.
Stage Code Sequence	(0040,000A)	3	Coded stage name of stress test. Sent if image is acquired in a stress test. The name is defined in the User Interface.
>Include 'Code Sequence Macro'			
Stage Number	(0008,2122)	3	Number of stage, starting at one. Sent if image is acquired in a stress test.
View Name	(0008,2127)	3	Name of view of stress test. Sent if image is acquired in a stress test. The name is defined in the User Interface.
View Code Sequence	(0054,0220)	3	Coded view name of stress test. Sent if image is acquired in a stress test. The name is defined in the User Interface
>Include 'Code Sequence Macro'			
View Number	(0008,2128)	3	Number of view, starting at one. Sent if image is acquired in a stress test.
Number of Event Timers	(0008,2129)	3	Only used when reading images
Event Elapsed Time(s)	(0008,2130)	3	Only used when reading images
Event Timer Name(s)	(0008,2132)	3	Only used when reading images
Anatomic Region Sequence	(0008,2218)	3	Not used
>Include 'Code Sequence Macro'			
>Anatomic Region Modifier Sequence	(0008,2220)	3	Not used
>>Include 'Code Sequence Macro'			
Primary Anatomic Structure Sequence	(0008,2228)	3	Not used
>Include 'Code Sequence Macro'			
>Primary Anatomic Structure Modifier Sequence	(0008,2230)	3	Not used
>>Include 'Code Sequence Macro'			

<b>Attribute Name</b>	<b>Tag</b>	<b>Type</b>	<b>Attribute Description</b>
Trigger Time	(0018,1060)	3	Not used
Nominal Interval	(0018,1062)	3	Not used
Beat Rejection Flag	(0018,1080)	3	Not used
Low R-R Value	(0018,1081)	3	Not used
High R-R Value	(0018,1082)	3	Not used
Heart Rate	(0018,1088)	3	Set to heart rate
Output Power	(0018,5000)	3	Not used
Transducer Data	(0018,5010)	3	Not used
Transducer Type	(0018,6031)	3	Not used
Focus Depth	(0018,5012)	3	Not used
Preprocessing Function	(0018,5020)	3	Not used
Mechanical Index	(0018,5022)	3	Not used
Bone Thermal Index,	(0018,5024)	3	Not used
Cranial Thermal Index	(0018,5026)	3	Not used
Soft Tissue Thermal Index	(0018,5027)	3	Not used
Soft Tissue-focus Thermal Index	(0018,5028)	3	Not used
Soft Tissue-surface Thermal Index	(0018,5029)	3	Not used
Depth of Scan Field	(0018,5050)	3	Not used
Image Transformation Matrix	(0018,5210)	3	Not used
Image Translation Vector	(0018,5212)	3	Not used
Overlay Subtype	(60xx,0045)	3	Not used



## **5. ULTRASOUND MULTIFRAME (US MF) INFORMATION OBJECT IMPLEMENTATION**

### **5.1 INTRODUCTION**

This section specifies the use of the DICOM US Multi-frame Image IOD to represent the information included in US images produced by this implementation. Corresponding attributes are conveyed using the module construct. The contents of this section are:

5.2 - IOD Implementation

5.3 - IOD Entity-Relationship Model

5.4 - IOD Module Table

5.5 - IOD Module Definition

### **5.2 US MF IOD IMPLEMENTATION**

This section defines the implementation of US Multi-Frame image information object.

### **5.3 US MF ENTITY-RELATIONSHIP MODEL**

The Entity-Relationship diagram for the US MF Image interoperability schema is shown in Illustration 5.3-1. In this figure, the following diagrammatic convention is established to represent the information organization:

- each entity is represented by a rectangular box
- each relationship is represented by a diamond shaped box.
- the fact that a relationship exists between two entities is depicted by lines connecting the corresponding entity boxes to the relationship boxes.

The relationships are fully defined with the maximum number of possible entities in the relationship shown. In other words, the relationship between Series and Image can have up to n Images per Series, but the Patient to Study relationship has 1 Patient for each Study (a Patient can have more than one Study on the system, however each Study will contain all of the information pertaining to that Patient).

ILLUSTRATION 5.3-1  
 US MULTIFRAME IMAGE ENTITY RELATIONSHIP DIAGRAM

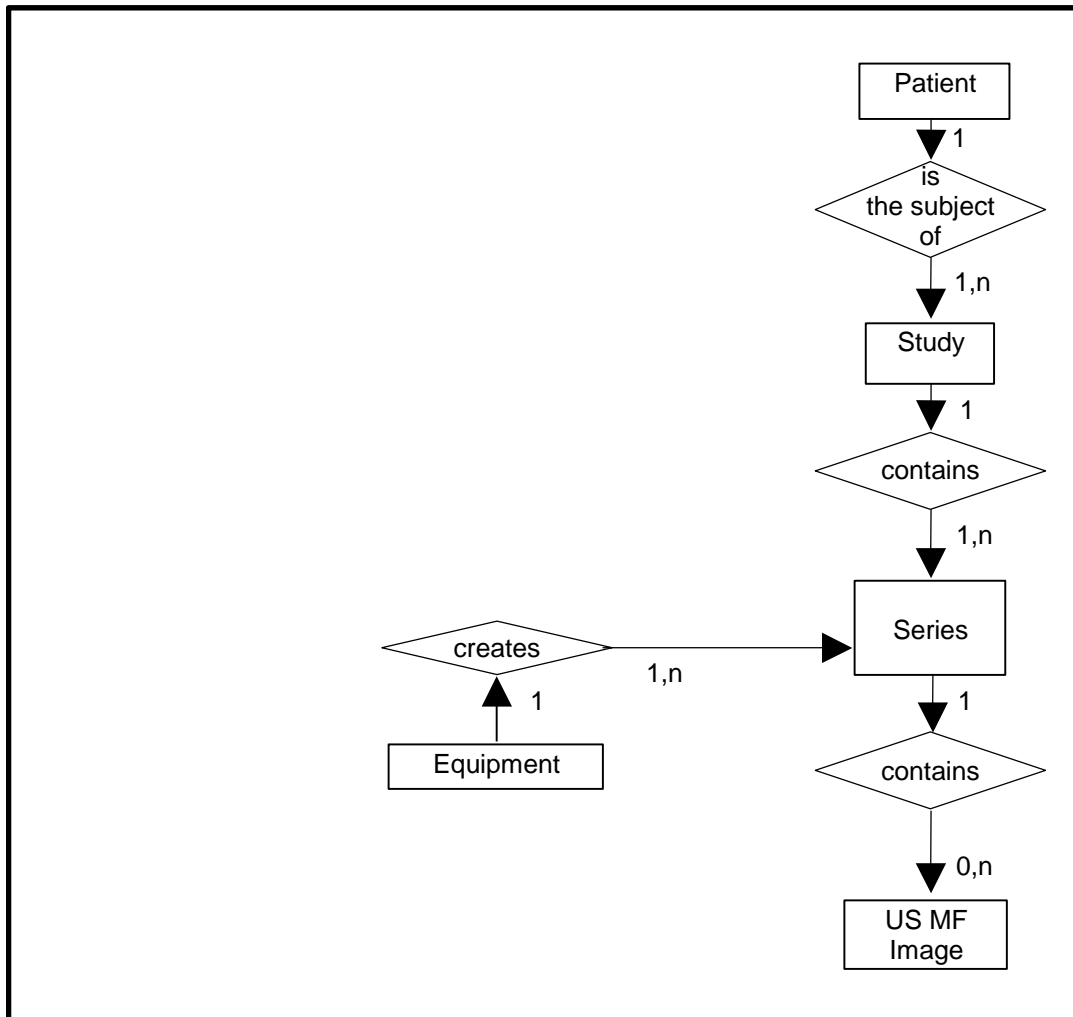

**5.3.1 Entity Descriptions**

Please refer to DICOM Standard Part 3 (Information Object Definitions) for a description of each of the entities contained within the US Multi-Frame Information Object.

**5.3.2 EchoPAC PC Mapping of DICOM entities**

TABLE 5.3-1  
 MAPPING OF DICOM ENTITIES TO ECHOPAC PC ENTITIES

DICOM	EchoPAC PC Entity
Patient	Patient
Study	Exam
Series	Exam
Image	Image
Curve	Not used

**5.4 IOD MODULE TABLE**

Within an entity of the DICOM US Multi-Frame IOD, attributes are grouped into related set of attributes. A set of related attributes is termed a module. A module facilitates the understanding of the semantics concerning the attributes and how the attributes are related with each other. A module grouping does not infer any encoding of information into datasets.

Table 5.4-1 identifies the defined modules within the entities, which comprise the DICOM US Multi-Frame IOD. Modules are identified by Module Name.

See DICOM Part 3 for a complete definition of the entities, modules, and attributes.

**TABLE 5.4-1**  
**US MULTI-FRAME IOD MODULES**

<b>Entity Name</b>	<b>Module Name</b>	<b>Reference</b>
Patient	Patient	4.5.1.1
Study	General Study	4.5.2.1
	Patient Study	4.5.2.2
Series	General Series	4.5.3.1
Frame of Reference	Frame of Reference	Not used
	US Frame of Reference	Not used
Equipment	General Equipment	4.5.4.1
Image	General Image	4.5.5.1
	Image Pixel	4.5.5.2
	Contrast/Bolus	4.5.5.3
	Cine	5.5.1.1
	Multi-frame	5.5.1.2
	Palette Color Lookup Table	4.5.5.4
	US Region Calibration	4.5.7.1
	US Image	4.5.7.2
Curve	Overlay Plane	Not used
	VOI LUT	4.5.5.5
	SOP Common	4.5.6.1
Curve	Not used	

**5.5 INFORMATION MODULE DEFINITIONS**

Please refer to DICOM Standard Part 3 (Information Object Definitions) for a description of each of the entities and modules contained within the US Multi-Frame Information Object.

The following modules are included to convey Enumerated Values, Defined Terms, and Optional Attributes supported. Type 1 & Type 2 Attributes are also included for completeness and to define what values they may take and where these values are obtained. It should be noted that they are the same ones as defined in the DICOM Standard Part 3 (Information Object Definitions).

**5.5.1 Common Image Modules**

The following Image IE Modules are common to all Composite Image IODs which reference the Image IE.

**5.5.1.1 Cine Module**

**TABLE 5.5-2**  
**CINE MODULE ATTRIBUTES**

<b>Attribute Name</b>	<b>Tag</b>	<b>Type</b>	<b>Attribute Description</b>
Frame Time	(0018,1063)	1C	Is set to the interframe time
Frame Time Vector	(0018,1065)	1C	Supported. Reading: Average value is set to interframe time
Start Trim	(0008,2142)	3	Supported
Stop Trim	(0008,2143)	3	Supported
Recommended Display Frame Rate	(0008,2144)	3	Supported
Cine Rate	(0018,0040)	3	Supported
Frame Delay	(0018,1066)	3	Supported
Effective Duration	(0018,0072)	3	Supported
Actual Frame Duration	(0018,1242)	3	Supported
Preferred Playback Sequencing	(0018,1244)	3	Supported

**5.5.1.2 Multi-frame Module**

**TABLE 5.5-3**  
**MULTI-FRAME MODULE ATTRIBUTES**

<b>Attribute Name</b>	<b>Tag</b>	<b>Type</b>	<b>Attribute Description</b>
Number of Frames	(0028,0008)	1	Is set to the number of frames in image
Frame Increment Pointer	(0028,0009)	1	Is set to Frame Time (0018,1063) or Frame Time Vector (0018,1065)

## **6. SC INFORMATION OBJECT IMPLEMENTATION**

### **6.1 INTRODUCTION**

This section specifies the use of the DICOM SC Image IOD to represent the information included in SC images produced by this implementation. Corresponding attributes are conveyed using the module construct. The contents of this section are:

6.2 - IOD Implementation

6.3 - IOD Entity-Relationship Model

6.4 - IOD Module Table

6.5 - IOD Module Definition

### **6.2 SC IOD IMPLEMENTATION**

This section defines the implementation of SC image information object.

### **6.3 SC ENTITY-RELATIONSHIP MODEL**

The Entity-Relationship diagram for the SC Image interoperability schema is shown in Illustration 6.3-1. In this figure, the following diagrammatic convention is established to represent the information organization:

- each entity is represented by a rectangular box
- each relationship is represented by a diamond shaped box.
- the fact that a relationship exists between two entities is depicted by lines connecting the corresponding entity boxes to the relationship boxes.

The relationships are fully defined with the maximum number of possible entities in the relationship shown. In other words, the relationship between Series and Image can have up to n Images per Series, but the Patient to Study relationship has 1 Patient for each Study (a Patient can have more than one Study on the system, however each Study will contain all of the information pertaining to that Patient).

ILLUSTRATION 6.3-1  
 SC IMAGE ENTITY RELATIONSHIP DIAGRAM

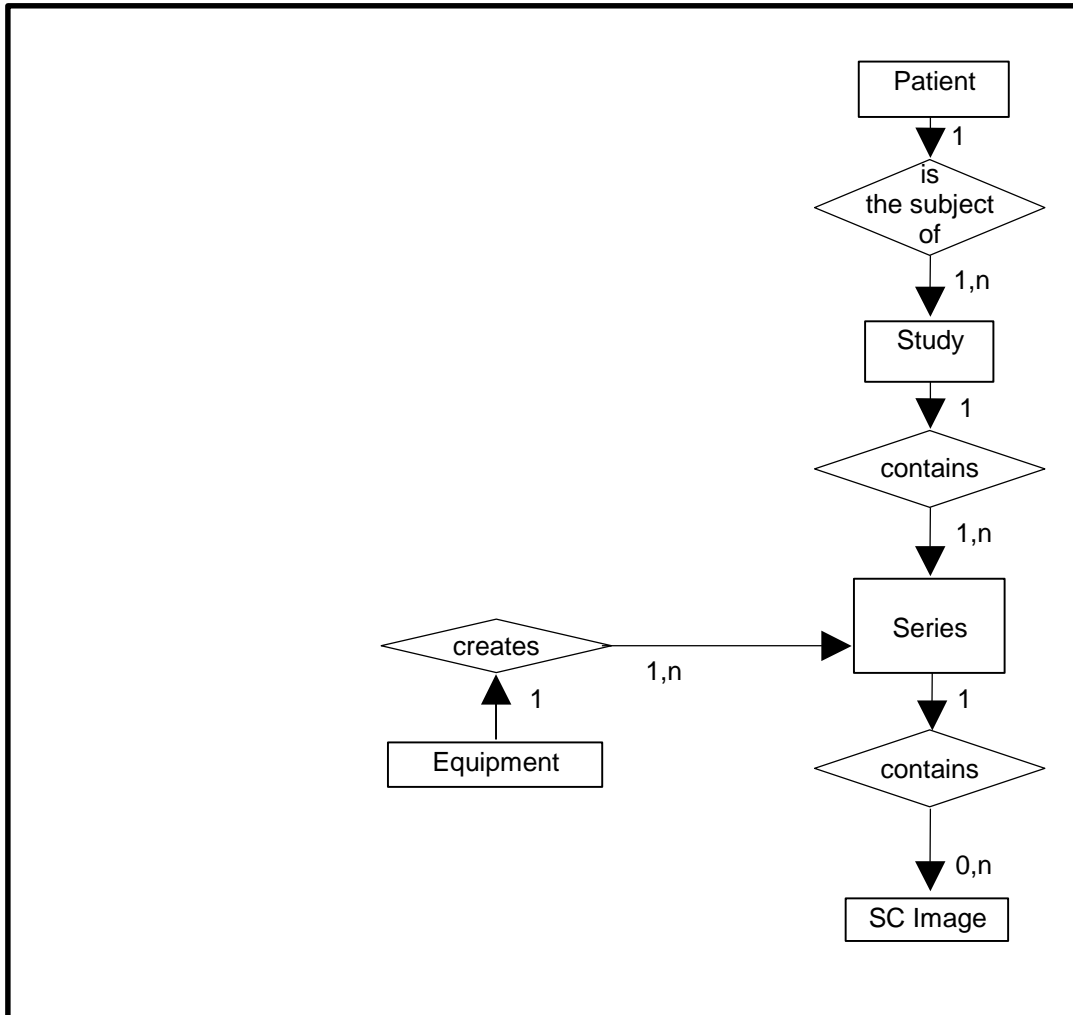

6.3.1 Entity Descriptions

Please refer to DICOM Standard Part 3 (Information Object Definitions) for a description of each of the entities contained within the SC Information Object.

6.3.2 EchoPAC PC Mapping of DICOM Entities

TABLE 6.3-1  
 MAPPING OF DICOM ENTITIES TO ECHOPAC PC ENTITIES

DICOM	EchoPAC PC Entity
Patient	Patient
Study	Exam
Series	Exam
Image	Image
Frame	Not Applicable

**6.4 IOD MODULE TABLE**

Within an entity of the DICOM SC IOD, attributes are grouped into related set of attributes. A set of related attributes is termed a module. A module facilitates the understanding of the semantics concerning the attributes and how the attributes are related with each other. A module grouping does not infer any encoding of information into datasets.

Table 6.4-1 identifies the defined modules within the entities, which comprise the DICOM SC IOD. Modules are identified by Module Name.

See DICOM Part 3 for a complete definition of the entities, modules, and attributes.

**TABLE 6.4-1**  
**SC IMAGE IOD MODULES**

<b>Entity Name</b>	<b>Module Name</b>	<b>Reference</b>
Patient	Patient	4.5.1.1
Study	General Study	4.5.2.1
	Patient Study	4.5.2.2
Series	General Series	4.5.3.1
	Equipment	General Equipment
	SC Equipment	6.5.1.1
Image	General Image	4.5.5.1
	Image Pixel	4.5.5.2
	SC Image	6.5.1.2
	Overlay Plane	Not used
	Modality LUT	Not used
	VOI LUT	4.5.5.5
	SOP Common	4.5.6.1

**6.5 INFORMATION MODULE DEFINITIONS**

Please refer to DICOM Standard Part 3 (Information Object Definitions) for a description of each of the entities and modules contained within the SC Information Object.

The following modules are included to convey Enumerated Values, Defined Terms, and Optional Attributes supported. Type 1 & Type 2 Attributes are also included for completeness and to define what values they may take and where these values are obtained. It should be noted that they are the same ones as defined in the DICOM Standard Part 3 (Information Object Definitions).

**6.5.1 SC Modules**

This Section describes SC Equipment, and Image Modules. These Modules contain attributes that are specific to SC Image IOD.

**6.5.1.1 SC Equipment Module**

This Module describes equipment used to convert images into a DICOM format.

**TABLE 6.5-2**  
**SC IMAGE EQUIPMENT MODULE ATTRIBUTES**

<b>Attribute Name</b>	<b>Tag</b>	<b>Type</b>	<b>Attribute Description</b>
Conversion Type	(0008,0064)	1	Set to WSD
Modality	(0008,0060)	3	Defined Value "US" used.
Secondary Capture Device ID	(0018,1010)	3	Defined Value "EchoPAC PC" or "EchoPAC PC SW-Only"
Secondary Capture Device Manufacturer	(0018,1016)	3	Implementation defined string "GE Vingmed Ultrasound"
Secondary Capture Device Manufacturer's Model Name	(0018,1018)	3	Implementation defined string "EchoPAC PC" or "EchoPAC PC SW-Only"
Secondary Capture Device Software Version	(0018,1019)	3	Is set to EchoPAC PC software version
Video Image Format Acquired	(0018,1022)	3	Not used
Digital Image Format Acquired	(0018,1023)	3	Not used

**6.5.1.2 SC Image Module**

The table in this Section contains IOD attributes that describe SC images.

**TABLE 6.5-3**  
**SC IMAGE MODULE ATTRIBUTES**

<b>Attribute Name</b>	<b>Tag</b>	<b>Type</b>	<b>Attribute Description</b>
Date of Secondary Capture	(0018,1012)	3	Image capture date
Time of Secondary Capture	(0018,1014)	3	Image capture time



## **7. SR INFORMATION OBJECT IMPLEMENTATION**

Note: If “Use older SR version” is enabled (see 2.6 and 3.6) the corresponding section present in the DICOM Conformance Statement of the selected version should be used.

Supported older SR version: 110 (BT11). The corresponding DICOM Conformance Statement is entitled:

*EchoPAC PC version 10*  
*Conformance Statement for DICOM*  
*Direction DOC0687360*

### **7.1 INTRODUCTION**

This section specifies the use of the DICOM Comprehensive SR IOD to represent results produced by this implementation. Corresponding attributes are conveyed using the module construct. The contents of this section are:

7.2- IOD Implementation

7.3 - IOD Entity-Relationship Model

7.4 - IOD Module Table

7.5 - IOD Module Definition

In this section, supported means that tag is sent with value.

### **7.2 COMPREHENSIVE SR IOD IMPLEMENTATION**

This section defines the implementation of Comprehensive SR information object.

### **7.3 COMPREHENSIVE SR ENTITY-RELATIONSHIP MODEL**

The Entity-Relationship diagram for the Comprehensive SR interoperability schema is shown in Illustration 4.3-1. In this figure, the following diagrammatic convention is established to represent the information organization:

- each entity is represented by a rectangular box
- each relationship is represented by a diamond shaped box.
- the fact that a relationship exists between two entities is depicted by lines connecting the corresponding entity boxes to the relationship boxes.

The relationships are fully defined with the maximum number of possible entities in the relationship shown. In other words, the relationship between Series and SR Documents can have up to n SR Documents per Series, but the Patient to Study relationship has 1 Patient for each Study (a Patient can have more than one Study on the system, however each Study will contain all of the information pertaining to that Patient).

ILLUSTRATION 7.3-1  
 COMPREHENSIVE SR ENTITY RELATIONSHIP DIAGRAM

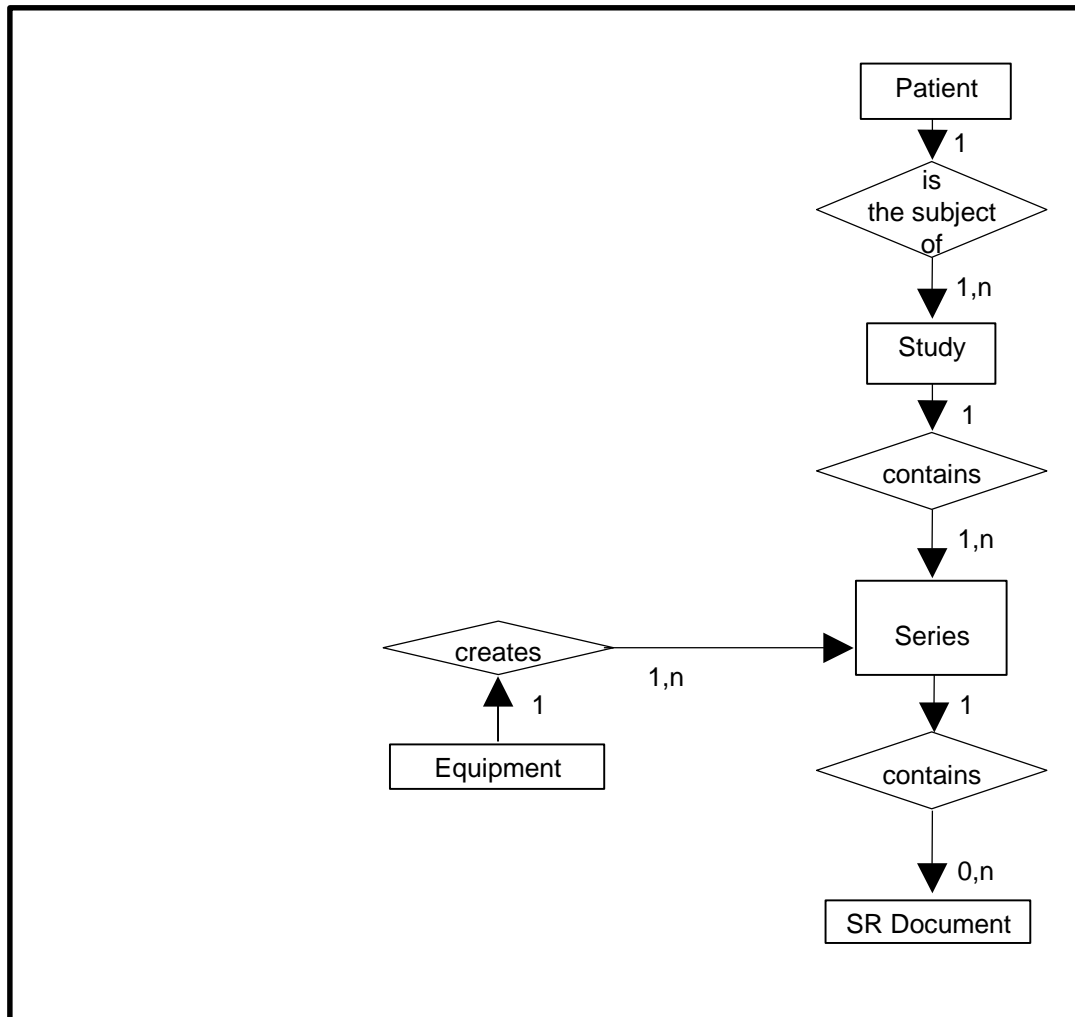

7.3.1 Entity Descriptions

Please refer to DICOM Standard Part 3 (Information Object Definitions) for a description of each of the entities contained within the Comprehensive SR Information Object.

7.3.2 EchoPAC PC Mapping of DICOM Entities

TABLE 7.3-1  
 MAPPING OF DICOM ENTITIES TO ECHOPAC PC ENTITIES

DICOM	EchoPAC PC Entity
Patient	Patient
Study	Exam
Series	Exam
SR Document	Results

**7.4 IOD MODULE TABLE**

Within an entity of the DICOM Comprehensive SR IOD, attributes are grouped into related set of attributes. A set of related attributes is termed a module. A module facilitates the understanding of the semantics concerning the attributes and how the attributes are related with each other. A module grouping does not infer any encoding of information into data sets.

Table 4.4-1 identifies the defined modules within the entities, which comprise the DICOM Comprehensive SR IOD. Modules are identified by Module Name.

See DICOM Part 3 for a complete definition of the entities, modules, and attributes.

**TABLE 7.4-1**  
**COMPREHENSIVE SR IMAGE IOD MODULES**

<b>Entity Name</b>	<b>Module Name</b>	<b>Reference</b>
Patient	Patient	4.5.1.1
	Specimen Identification	Not used
Study	General Study	4.5.2.1
	Patient Study	4.5.2.2
Series	SR Document Series	7.5.1
Equipment	General Equipment	4.5.4.1
Document	SR Document General	7.5.2
	SR Document Content	7.5.3
	SOP Common	4.5.6.1

**7.5 INFORMATION MODULE DEFINITIONS**

Please refer to DICOM Standard Part 3 (Information Object Definitions) for a description of each of the entities and modules contained within the Comprehensive SR Information Object.

The following modules are included to convey Enumerated Values, Defined Terms, and Optional Attributes supported. Type 1 & Type 2 Attributes are also included for completeness and to define what values they may take and where these values are obtained. It should be noted that they are the same ones as defined in the DICOM Standard Part 3 (Information Object Definitions).

7.5.1 SR Document Series Module

TABLE 7.5-1  
SR DOCUMENT SERIES MODULE

Attribute Name	Tag	Type	Attribute Description
Modality	(0008,0060)	1	Defined Term "SR" used.
Series Instance UID	(0020,000E)	1	Uniquely generated by the equipment
Series Number	(0020,0011)	1	Internal number which is incremented for each new series within a study.
Series Date	(0020,0021)	3	Not used
Series Time	(0020,0031)	3	Not used
Series Description	(0020,103E)	3	Not used
Referenced Performed Procedure Step Sequence	(0008,1111)	2	Not used.
>Referenced SOP Class UID	(0008,1150)	1C	Not used.
>Referenced SOP Instance UID	(0008,1155)	1C	Not used.

7.5.2 SR Document General Module

TABLE 7.5-2  
SR DOCUMENT GENERAL MODULE

Attribute Name	Tag	Type	Attribute Description
Instance Number	(0020,0013)	1	Internal number which is incremented for each new SR document within a series.
Completion Flag	(0040,A491)	1	Defined Term "PARTIAL" used.
Completion Flag Description	(0040,A492)	3	Not used
Verification Flag	(0040,A493)	1	Defined Term "UNVERIFIED" used.
Content Date	(0008,0023)	1	Date of creation
Content Time	(0008,0033)	1	Time of creation
Verifying Observer Sequence	(0040,A073)	1C	Not used
>Verifying Observer Name	(0040,A075)	1	
>Verifying Observer Identification Code Sequence	(0040,A088)	2	
>>Include 'Code Sequence Macro'			
>Verifying Organization	(0040,A027)	1	
>Verification DateTime	(0040,A030)	1	
Predecessor Documents Sequence	(0040,A360)	1C	Not used.
>Include 'SOP Instance Reference Macro'			

Identical Documents Sequence	(0040,A525)	1C	Not used
>Include 'SOP Instance Reference Macro'			
Referenced Request Sequence	(0040,A370)	1C	
>Study Instance UID	(0020,000D)	1	Taken from Study Instance UID in General Study Module
>Referenced Study Sequence	(0008,1110)	2	Always empty
>>Referenced SOP Class UID	(0008,1150)	1	
>>Referenced SOP Instance UID	(0008,1155)	1	
>Accession Number	(0008,0050)	2	Taken from Accession Number in General Study Module
>Placer Order Number/Imaging Service Request	(0040,2016)	2	Always empty
>Filler Order Number/Imaging Service Request	(0040,2017)	2	Always empty
>Requested Procedure ID	(0040,1001)	2	Always empty
>Requested Procedure Description	(0032,1060)	2	Always empty
>Requested Procedure Code Sequence	(0032,1064)	2	Always empty
>>Include 'Code Sequence Macro'			
Performed Procedure Code Sequence	(0040,A372)	2	Always empty
>Include 'Code Sequence Macro'			
Current Requested Procedure Evidence Sequence	(0040,A375)	1C	Not used.
>Study Instance UID	(0020,000D)	1	
>Referenced Series Sequence	(0008,1115)	1	
>>Series Instance UID	(0020,000E)	1	
>>Retrieve AE Title	(0008,0054)	3	Not used
>>Storage Media File-Set ID	(0088,0130)	3	Not used
>>Storage Media File-Set UID	(0088,0140)	3	Not used
>>Referenced SOP Sequence	(0008,1199)	1	
>>>Referenced SOP Class UID	(0008,1150)	1	
>>>Referenced SOP Instance UID	(0008,1155)	1	
Pertinent Other Evidence Sequence	(0040,A385)	1C	Not used
>Include 'SOP Instance Reference Macro'			

**7.5.3 SR Document Content Module**

The SR Document Content Module is described in the following table.

**TABLE 7.5-2**  
**SR DOCUMENT CONTENT MODULE ATTRIBUTES**

Attribute Name	Tag	Type	Attribute Description
Observation DateTime	(0040,A032)	1C	Not used
Content Template Sequence	(0040,A504)	1C	Template id 5200 or 5100 from DCMR.
> <i>'Template Identification Macro'</i>			
Value Type	(0040,A040)	1	CONTAINER
Continuity of Content	(0040,A050)	1C	SEPARATE
Concept Name Code Sequence	(0040,A043)	1C	“Adult Echocardiography Procedure Report” or “Vascular Ultrasound Procedure Report”
> <i>'Code Sequence Macro'</i>			
<i>Concept Value attribute(s)</i>			Not used for CONTAINER
Content Sequence	(0040,A730)	1C	See template “Adult Echocardiography Procedure Report” or “Vascular Ultrasound Procedure Report”.
> Relationship Type	(0040,A010)	1	See template “Adult Echocardiography Procedure Report” or “Vascular Ultrasound Procedure Report”.
> Referenced Content Item Identifier	(0040,DB73)	1C	Not used
> <i>SR Document Content Module</i>			See template “Adult Echocardiography Procedure Report” and “Vascular Ultrasound Procedure Report”.

SR Document on template “Adult Echocardiography Procedure Report” is created if there are measurements in “Cardiac” or “Pediatric” M&A categories.

SR Document on template “Vascular Ultrasound Procedure Report” is created if there are measurements in “Vascular” or “Abdomen” M&A categories.

If there are measurements from both category groups, both SR Documents will be created.

### 7.5.3.1 SR Document Content Descriptions

#### 7.5.3.1.1 Content Template

EchoPAC PC supports the following root Templates for SR SOP Instances created by EchoPAC PC.

**TABLE 7.5-3**  
**SR ROOT TEMPLATES**

SOP Class	Template ID	Template Name	Use
Comprehensive SR	5200	“Adult Echocardiography Procedure Report”	Create
Comprehensive SR	5100	“Vascular Ultrasound Procedure Report”	Create

The mappings from the product’s internal measurement names to DICOM SR encoding are in chapters 12 and 13.

**7.6 STANDARD EXTENDED AND PRIVATE DATA ATTRIBUTES**

If so configured, the product will send exam information in private data elements designated by the Private Creator element:

<b>Element Name</b>	<b>Tag</b>	<b>VR</b>	<b>VM</b>	<b>Description</b>
Private Creator	6005,00xx	LO	1	GEMS_Ultrasound_ExamGroup_001

This means that all private tags starting with 6005,xx will belong to the GEMS\_Ultrasound\_ExamGroup\_001.

**7.7 STANDARD EXTENDED AND PRIVATE CONTEXT GROUPS**

The product uses the standard extended context groups as described in chapters 12 and 13.

**7.8 STANDARD EXTENDED AND PRIVATE TEMPLATES**

The product uses the standard extended templates as described in chapters 12 and 13.

**7.8.1 Standard Extended Templates**

The product uses the standard extended templates as described in chapters 12 and 13.

**7.8.2 Private Templates**

Not applicable.

## **8. BASIC DIRECTORY INFORMATION OBJECT IMPLEMENTATION**

### **8.1 INTRODUCTION**

This section specifies the use of the DICOM Basic Directory IOD to represent the information included in directories produced by this implementation. Corresponding attributes are conveyed using the module construct. The contents of this section are:

8.2 - IOD Implementation

8.3 - IOD Entity-Relationship Model

8.4- IOD Module Table

8.5 - IOD Module Definition

### **8.2 BASIC DIRECTORY IOD IMPLEMENTATION**

This section defines the implementation of Basic Directory information object.

### **8.3 BASIC DIRECTORY ENTITY-RELATIONSHIP MODEL**

The Entity-Relationship diagram for the Basic Directory interoperability schema is shown in Illustration 8.3-1. In this figure, the following diagrammatic convention is established to represent the information organization:

- each entity is represented by a rectangular box
- each relationship is represented by a diamond shaped box
- the fact that a relationship exists between two entities is depicted by lines connecting the corresponding entity boxes to the relationship boxes.

#### **8.3.1 EchoPAC PC Mapping of DICOM entities**

**TABLE 8.3-1**  
**MAPPING OF DICOM ENTITIES TO ECHOPAC PC ENTITIES**

<b>DICOM</b>	<b>EchoPAC PC</b>
Patient	Patient
Study	Exam
Series	Exam
Image or SR Document	Image or Results



ILLUSTRATION 8.3-1  
BASIC DIRECTORY ENTITY RELATIONSHIP DIAGRAM

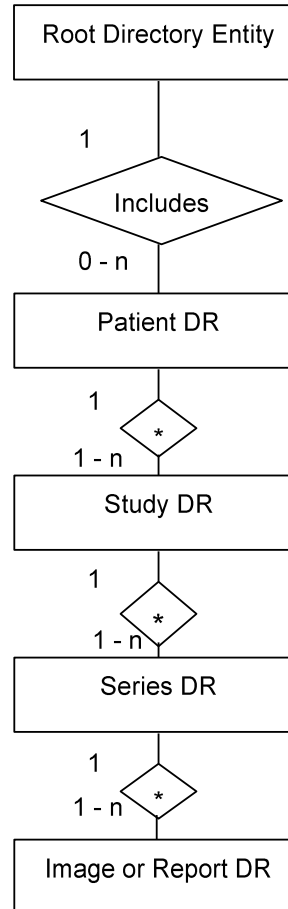

#### 8.4 IOD MODULE TABLE

Within an entity of the Basic Directory IOD, attributes are grouped into related set of attributes. A set of related attributes is termed a module. A module facilitates the understanding of the semantics concerning the attributes and how the attributes are related with each other. A module grouping does not infer any encoding of information into datasets.

Table 8.4-1 identifies the defined modules within the entities, which comprise the Basic Directory IOD. Modules are identified by Module Name.

See DICOM Part 3 for a complete definition of the entities, modules, and attributes.

**TABLE 8.4-1**  
**BASIC DIRECTORY IOD MODULES**

Entity Name	Module Name	Reference
File Set Identification	File Set Identification	8.5.1.1
Directory Information	Directory Information	8.5.2.1

The Directory Information Module is created when initializing the media. If it already exists, the existing information is not changed regarding patient, study, series or image/result data.

An existing Directory Information Module may have been obtained from application entities using removable media. These instances are external to this conformance claim and the origin of the SOP instances is outside the scope of this claim.

**8.5 INFORMATION MODULE DEFINITIONS**

Please refer to DICOM Standard Part 3 (Information Object Definitions) for a description of each of the entities and modules contained within the Basic Directory Information Object.

The following modules are included to convey Enumerated Values, Defined Terms, and Optional Attributes supported. Type 1 & Type 2 Attributes are also included for completeness and to define what values they may take and where these values are obtained. It should be noted that they are the same ones as defined in the DICOM Standard Part 3 (Information Object Definitions).

**8.5.1 Common File Set identification Modules**

**8.5.1.1 File Set identification Module**

**TABLE 8.5-1**  
**FILE-SET IDENTIFICATION MODULE**

Attribute Name	Tag	Type	Attribute Description
File-set ID	(0004,1130)	2	Has NULL value
File-set Descriptor File ID	(0004,1141)	3	Not used
Specific Character Set of File-set Descriptor File	(0004,1142)	1C	Not used

**8.5.2 Common Directory Information Modules**

**8.5.2.1 Directory Information Module**

**TABLE 8.5-2**  
**DIRECTORY INFORMATION MODULE**

Attribute Name	Tag	Type	Attribute Description
Offset of the First Directory Record of the Root Directory Entity	(0004,1200)	1	Is set
Offset of the Last Directory Record of the Root Directory Entity	(0004,1202)	1	Is set

Attribute Name	Tag	Type	Attribute Description
File-set Consistency Flag	(0004,1212)	1	FSC/FSU: Has the value 0000H: no known inconsistencies, ignored when reading
Directory Record Sequence	(0004,1220)	2	Is created by FSC
>Offset of the Next Directory Record	(0004,1400)	1C	Is set
>Record In-use Flag	(0004,1410)	1C	FSC/FSR: Is set to FFFFH FSR: A value of 0000H: imply skipping this record
>Offset of Referenced Lower-Level Directory Entity	(0004,1420)	1C	Is set
>Directory Record Type	(0004,1430)	1C	The values support by FSC and FSU are PATIENT STUDY SERIES IMAGE SR DOCUMENT
>Private Record UID	(0004,1432)	1C	Not used
>Referenced File ID	(0004,1500)	1C	Is set if Directory Record Type is IMAGE or SR DOCUMENT Contains the file path consisting of 5 elements: 1. "GEMS_IMG" (if IMAGE) or "GEMS_REP" (if SR DOCUMENT) 2. Month of exam 3. Day of exam 4. Patient initials and time of exam 5. Time stamp
>Referenced SOP Class UID in File	(0004,1510)	1C	Is set to the SOP class UID in File if Directory Record Type is IMAGE or SR DOCUMENT
>Referenced SOP Instance UID in File	(0004,1511)	1C	Is set to the SOP instance UID in File if Directory Record Type is IMAGE or SR DOCUMENT
>Referenced Transfer Syntax UID in File	(0004,1512)	1C	Is set to the Transfer Syntax UID in File if Directory Record Type is IMAGE or SR DOCUMENT
>Record Selection Keys			See 8.5.3.

8.5.3 Definition of Specific Directory Records

8.5.3.1 Patient Directory Record Definition

TABLE 8.5-3  
PATIENT KEYS

Key	Tag	Type	Attribute Description
Specific Character Set	(0008,0005)	1C	Is filled in by FSC and FSU as in chapter 4, 5, 6 and 7.
Patient's Name	(0010,0010)	2	Is filled in by FSC and FSU as in chapter 4, 5, 6 and 7.
Patient ID	(0010,0020)	1	Is filled in by FSC and FSU as in chapter 4, 5, 6 and 7. If empty, a Patient Id is created by the equipment.
Patient's Birth Date	(0010,0030)	3	Is filled in by FSC and FSU as in chapter 4, 5, 6 and 7.
Patient's Sex	(0010,0040)	3	Is filled in by FSC and FSU as in chapter 4, 5, 6 and 7.
Referenced Patient Sequence	(0008,1120)	3	Is filled in by FSC and FSU as in chapter 4, 5, 6 and 7.
>Referenced SOP Class UID	(0008,1150)	1C	Is filled in by FSC and FSU as in chapter 4, 5, 6 and 7.
>Referenced SOP Instance UID	(0008,1155)	1C	Is filled in by FSC and FSU as in chapter 4, 5, 6 and 7.
Patient's Birth Time	(0010,0032)	3	Is filled in by FSC and FSU as in chapter 4, 5, 6 and 7.
Other Patient Ids	(0010,1000)	3	Is filled in by FSC and FSU as in chapter 4, 5, 6 and 7.
Other Patient Names	(0010,1001)	3	Is filled in by FSC and FSU as in chapter 4, 5, 6 and 7.
Ethnic Group	(0010,2160)	3	Is filled in by FSC and FSU as in chapter 4, 5, 6 and 7.
Patient Comments	(0010,4000)	3	Is filled in by FSC and FSU as in chapter 4, 5, 6 and 7.

8.5.3.2 Study Directory Record Definition

TABLE 8.5-4  
STUDY KEYS

Key	Tag	Type	Attribute Description
Specific Character Set	(0008,0005)	1C	Is filled in by FSC and FSU as in chapter 4, 5, 6 and 7.
Study Instance UID	(0020,000D)	1C	Is filled in by FSC and FSU as in chapter 4, 5, 6 and 7.
Study Date	(0008,0020)	1	Is filled in by FSC and FSU as in chapter 4, 5, 6 and 7. If empty, a Study Date is created by the equipment.

Key	Tag	Type	Attribute Description
Study Time	(0008,0030)	1	Is filled in by FSC and FSU as in chapter 4, 5, 6 and 7. If empty, a Study Time is created by the equipment.
Referring Physician's Name	(0008,0090)	3	Is filled in by FSC and FSU as in chapter 4, 5, 6 and 7.
Study ID	(0020,0010)	1	Is filled in by FSC and FSU as in chapter 4, 5, 6 and 7. If empty, a Study Id is created by the equipment.
Accession Number	(0008,0050)	2	Is filled in by FSC and FSU as in chapter 4, 5, 6 and 7.
Study Description	(0008,1030)	2	Is filled in by FSC and FSU as in chapter 4, 5, 6 and 7.
Physician(s) of Record	(0008,1048)	3	Is filled in by FSC and FSU as in chapter 4, 5, 6 and 7.
Name of Physician(s) Reading Study	(0008,1060)	3	Is filled in by FSC and FSU as in chapter 4, 5, 6 and 7.
Referenced Study Sequence	(0008,1110)	3	Is filled in by FSC and FSU as in chapter 4, 5, 6 and 7.
>Referenced SOP Class UID	(0008,1150)	1C	Is filled in by FSC and FSU as in chapter 4, 5, 6 and 7.
>Referenced SOP Instance UID	(0008,1155)	1C	Is filled in by FSC and FSU as in chapter 4, 5, 6 and 7.
Admitting Diagnoses Description	(0008,1080)	3	Is filled in by FSC and FSU as in chapter 4, 5, 6 and 7.
Patient's Age	(0010,1010)	3	Is filled in by FSC and FSU as in chapter 4, 5, 6 and 7.
Patient's Size	(0010,1020)	3	Is filled in by FSC and FSU as in chapter 4, 5, 6 and 7.
Patient's Weight	(0010,1030)	3	Is filled in by FSC and FSU as in chapter 4, 5, 6 and 7.
Occupation	(0010,2180)	3	Is filled in by FSC and FSU as in chapter 4, 5, 6 and 7.
Additional Patient's History	(0010,21B0)	3	Is filled in by FSC and FSU as in chapter 4, 5, 6 and 7.

**8.5.3.3 Series Directory Record Definition**

**TABLE 8.5-5**  
**SERIES KEYS**

Key	Tag	Type	Attribute Description
Specific Character Set	(0008,0005)	1C	Is filled in by FSC or FSU as contained in the image or SR document message, if one of the tags contains extended characters
Modality	(0008,0060)	1	Is filled in by FSC and FSU as in chapter 4, 5, 6 and 7.

<b>Key</b>	<b>Tag</b>	<b>Type</b>	<b>Attribute Description</b>
Series Instance UID	(0020,000E)	1	Is filled in by FSC and FSU as in chapter 4, 5, 6 and 7.
Series Number	(0020,0011)	1	Is filled in by FSC and FSU as in chapter 4, 5, 6 and 7. If empty, a Series Number is created by the equipment.
Icon Image Sequence	(0088,0200)	3	Not used.
Series Date	(0008,0021)	3	Is filled in by FSC and FSU as in chapter 4, 5, 6 and 7 if instance is IMAGE.
Series Time	(0008,0031)	3	Is filled in by FSC and FSU as in chapter 4, 5, 6 and 7 if instance is IMAGE.
Performing Physicians' Name	(0008,1050)	3	Is filled in by FSC and FSU as in chapter 4, 5, 6 and 7 if instance is IMAGE.
Protocol Name	(0018,1030)	3	Is filled in by FSC and FSU as in chapter 4, 5, 6 and 7 if instance is IMAGE.
Series Description	(0008,103E)	3	Is filled in by FSC and FSU as in chapter 4, 5, 6 and 7 if instance is IMAGE.
Operator's Name	(0008,1070)	3	Is filled in by FSC and FSU as in chapter 4, 5, 6 and 7 if instance is IMAGE.
Referenced Performed Procedure Step Sequence	(0008,1111)	3	Is filled in by FSC and FSU as in chapter 4, 5, 6 and 7.
>Referenced SOP Class UID	(0008,1150)	1C	Is filled in by FSC and FSU as in chapter 4, 5, 6 and 7.
>Referenced SOP Instance UID	(0008,1155)	1C	Is filled in by FSC and FSU as in chapter 4, 5, 6 and 7.
Request Attributes Sequence	(0040,0275)	3	Is filled in by FSC and FSU as in chapter 4, 5, 6 and 7 if instance is IMAGE.
>Requested Procedure ID	(0040,1001)	1C	Is filled in by FSC and FSU as in chapter 4, 5, 6 and 7 if instance is IMAGE.
>Scheduled Procedure Step ID	(0040,0009)	1C	Is filled in by FSC and FSU as in chapter 4, 5, 6 and 7 if instance is IMAGE.
>Scheduled Procedure Step Description	(0040,0007)	3	Is filled in by FSC and FSU as in chapter 4, 5, 6 and 7 if instance is IMAGE.
>Scheduled Protocol Code Sequence	(0040,0008)	3	Is filled in by FSC and FSU as in chapter 4, 5, 6 and 7 if instance is IMAGE.

Key	Tag	Type	Attribute Description
>>Include 'Code Sequence Macro'			Is filled in by FSC and FSU as in chapter 4, 5, 6 and 7 if instance is IMAGE.
Performed Procedure Step ID	(0040,0253)	3	Is filled in by FSC and FSU as in chapter 4, 5, 6 and 7 if instance is IMAGE.
Performed Procedure Step Start Date	(0040,0244)	3	Is filled in by FSC and FSU as in chapter 4, 5, 6 and 7 if instance is IMAGE.
Performed Procedure Step Start Time	(0040,0245)	3	Is filled in by FSC and FSU as in chapter 4, 5, 6 and 7 if instance is IMAGE.
Performed Procedure Step Description	(0040,0254)	3	Is filled in by FSC and FSU as in chapter 4, 5, 6 and 7 if instance is IMAGE.
Performed Protocol Code Sequence	(0040,0260)	3	Is filled in by FSC and FSU as in chapter 4, 5, 6 and 7 if instance is IMAGE.
>Include 'Code Sequence Macro'			
Manufacturer	(0008,0070)	2	Is filled in by FSC and FSU as in chapter 4, 5, 6 and 7.
Institution Name	(0008,0080)	3	Is filled in by FSC and FSU as in chapter 4, 5, 6 and 7.
Station Name	(0008,1010)	3	Is filled in by FSC and FSU as in chapter 4, 5, 6 and 7.
Institutional Department Name	(0008,1040)	3	Is filled in by FSC and FSU as in chapter 4, 5, 6 and 7.
Manufacturer's Model Name	(0008,1090)	3	Is filled in by FSC and FSU as in chapter 4, 5, 6 and 7.
Software Versions	(0018,1020)	3	Is filled in by FSC and FSU as in chapter 4, 5, 6 and 7.

**8.5.3.4 Image Directory Record Definition**

**TABLE 8.5-6**  
**IMAGE KEYS**

Key	Tag	Type	Attribute Description
Specific Character Set	(0008,0005)	1C	Is filled in by FSC and FSU as in chapter 4, 5, 6 and 7.
Instance Number	(0020,0013)	1	Is filled in by FSC and FSU as in chapter 4, 5, 6 and 7. If empty, a Instance Number is created by the equipment.
Icon Image Sequence	(0088,0200)	3	Not used
Content Date	(0008,0023)	3	Is filled in by FSC and FSU as in chapter 4, 5, 6 and 7.
Content Time	(0008,0033)	3	Is filled in by FSC and FSU as in chapter 4, 5, 6 and 7.

Image Type	(0008,0008)	3	Is filled in by FSC and FSU as in chapter 4, 5, 6 and 7.
Rows	(0028,0010)	3	Is filled in by FSC and FSU as in chapter 4, 5, 6 and 7.
Columns	(0028,0011)	3	Is filled in by FSC and FSU as in chapter 4, 5, 6 and 7.
Number Of Frames	(0028,0008)	3	Is filled in by FSC and FSU as in chapter 4, 5, 6 and 7.
Photometric Interpretation	(0028,0004)	3	Is filled in by FSC and FSU as in chapter 4, 5, 6 and 7.
Contrast/Bolus Agent	(0018,0010)	2	Is filled in by FSC and FSU as in chapter 4, 5, 6 and 7.
Lossy Image Compression	(0028,2110)	3	Is filled in by FSC and FSU as in chapter 4, 5, 6 and 7.
Lossy Image Compression Ratio	(0028,2112)	3	Is filled in by FSC and FSU as in chapter 4, 5, 6 and 7.

**8.5.3.5 Report Directory Record Definition**

**TABLE 8.5-7**  
**SR DOCUMENT KEYS**

Key	Tag	Type	Attribute Description
Specific Character Set	(0008,0005)	1C	Is filled in by FSC and FSU as in chapter 4, 5, 6 and 7.
Instance Number	(0020,0013)	1	Is filled in by FSC and FSU as in chapter 4, 5, 6 and 7. If empty, a Instance Number is created by the equipment.
Content Date	(0008,0023)	1	Is filled in by FSC and FSU as in chapter 4, 5, 6 and 7.
Content Time	(0008,0033)	1	Is filled in by FSC and FSU as in chapter 4, 5, 6 and 7.
Completion Flag	(0040,A491)	1	Is filled in by FSC and FSU as in chapter 4, 5, 6 and 7.
Verification Flag	(0040,A493)	1	Is filled in by FSC and FSU as in chapter 4, 5, 6 and 7.
Concept Name Code Sequence	(0040,A043)	1	Is filled in by FSC and FSU as in chapter 4, 5, 6 and 7.
Content Sequence	(0040,A730)	1C	Not Used

**8.5.3.6 Private Directory Record Definition**

Not used.

**8.5.3.7 Multi-Referenced File Directory Record Definition**

Not used.



**8.6 PRIVATE DATA DICTIONARY**

If so configured, the product will send ultrasound raw data information in private data elements designated by the Private Creator element:

<b>Element Name</b>	<b>Tag</b>	<b>VR</b>	<b>VM</b>	<b>Description</b>
Private Creator	7FE1,00xx	LO	1	GEMS_Ultrasound_MovieGroup_001

This means that all private tags starting with 7FE1,xx will belong to the GEMS\_Ultrasound\_MovieGroup\_001.

If so configured, the product will send preview image in private data elements designated by the Private Creator element:

<b>Element Name</b>	<b>Tag</b>	<b>VR</b>	<b>VM</b>	<b>Description</b>
Private Creator	6003,00xx	LO	1	GEMS_Ultrasound_ImageGroup_001

This means that all private tags starting with 6003,xx will belong to the GEMS\_Ultrasound\_ImageGroup\_001.

If so configured, the product will send exam information in private data elements designated by the Private Creator element:

<b>Element Name</b>	<b>Tag</b>	<b>VR</b>	<b>VM</b>	<b>Description</b>
Private Creator	6005,00xx	LO	1	GEMS_Ultrasound_ExamGroup_001

This means that all private tags starting with 6005,xx will belong to the GEMS\_Ultrasound\_ExamGroup\_001.

## 9. STORAGE COMMITMENT PUSH MODEL SOP CLASS DEFINITION

### 9.1 INTRODUCTION

This section of the DICOM Conformance Statement specifies the Storage Commitment Push Model SOP Class, the optional attributes and service elements supported, the valid range of values for mandatory and optional attributes, and the status code behavior.

### 9.2 STORAGE COMMITMENT PUSH MODEL SOP CLASS DEFINITION

#### 9.2.1 IOD Description

##### 9.2.1.1 STORAGE COMMITMENT MODULE

**TABLE 9.2-1  
 STORAGE COMMITMENT MODULE**

Attribute Name	Tag	Attribute Description
Transaction UID	(0008,1195)	Uniquely generated by the equipment
Retrieve AE Title	(0008,0054)	Not used
Storage Media File-Set ID	(0088,0130)	Not used
Storage Media File-Set UID	(0088,0140)	Not used
Referenced SOP Sequence	(0008,1199)	Supported
>Referenced SOP Class UID	(0008,1150)	Supported
>Referenced SOP Instance UID	(0008,1155)	Supported
>Retrieve AE Title	(0008,0054)	Not used
>Storage Media File-Set ID	(0088,0130)	Not used
>Storage Media File-Set UID	(0088,0140)	Not used
Failed SOP Sequence	(0008,1198)	Supported
>Referenced SOP Class UID	(0008,1150)	Supported
>Referenced SOP Instance UID	(0008,1155)	Supported
>Failure Reason	(0008,1197)	Supported

#### 9.2.2 DIMSE Service Group

DIMSE Service Element	Usage SCU/SCP
N-EVENT-REPORT	M/M
N-ACTION	M/M

**9.2.3 Operations**

**9.2.3.1 Action Information**

**TABLE 9.2-2**  
**STORAGE COMMITMENT REQUEST - ACTION INFORMATION**

Action Type Name	Action Type ID	Attribute	Tag	Requirement Type SCU/SCP
Request Storage Commitment	1	Transaction UID	(0008,1195)	1/1
		Storage Media File-Set ID	(0088,0130)	Not used
		Storage Media File-Set UID	(0088,0140)	Not used
		Referenced SOP Sequence	(0008,1199)	1/1
		>Referenced SOP Class UID	(0008,1150)	1/1
		>Referenced SOP Instance UID	(0008,1155)	1/1
		>Storage Media File-Set ID	(0088,0130)	Not used
		>Storage Media File-Set UID	(0088,0140)	Not used

**9.2.3.2 Service Class User Behavior**

EchoPAC PC sends the N-ACTION primitive (Storage Commitment Request) after successful exam save to a DICOM Storage SCP.

EchoPAC PC may request storage commitment for all generated SOP Class UUIDs:

Ultrasound Multi-frame Image Storage	1.2.840.10008.5.1.4.1.1.3.1
Ultrasound Multi-frame Image Storage (Retired)	1.2.840.10008.5.1.4.1.1.3
Ultrasound Image Storage	1.2.840.10008.5.1.4.1.1.6.1

Ultrasound Image Storage (Retired)	1.2.840.10008.5.1.4.1.1.6
Secondary Capture Image Storage	1.2.840.10008.5.1.4.1.1.7
Comprehensive Structured Report	1.2.840.10008.5.1.4.1.1.88.33

The association for the N-ACTION is disconnected after processing the response. Thus, the N-EVENT-REPORT must be sent on a separate association.

The Referenced Study Component Sequence Attribute is not supported.

The Transaction UID is valid for two days. If no answer is received, the request will be removed without warning the user.

The optional Storage Media File-Set ID & UID Attributes in the N-ACTION are not supported.

**9.2.3.3 Status Codes**

No Service Class specific status values are defined for the N-ACTION Service. See PS 3.7 for general response status codes.

For this SOP class, all status codes with status Refused or Error are treated as failures and terminate the association and operation. All status codes with status Warning or Success are treated as successes.

**9.2.4 Notifications**

EchoPAC PC will only listen for an N-EVENT-REPORT from the SCP in a new association on the listen port for Verification and Storage Commitment.

Role Negotiation is supported and expected in the new association requested.

9.2.4.1 Event Information

TABLE 9.2-3  
STORAGE COMMITMENT RESULT - EVENT INFORMATION

Event Type Name	Event Type ID	Attribute	Tag	Requirement Type SCU/SCP
Storage Commitment Request Successful	1	Transaction UID	(0008,1195)	-/1
		Retrieve AE Title	(0008,0054)	Not used
		Storage Media File-Set ID	(0088,0130)	Not used
		Storage Media File-Set UID	(0088,0140)	Not used
		Referenced SOP Sequence	(0008,1199)	-/1
		>Referenced SOP Class UID	(0008,1150)	-/1
		>Referenced SOP Instance UID	(0008,1155)	-/1
		>Retrieve AE Title	(0008,0054)	Not used
		>Storage Media File-Set ID	(0088,0130)	Not used
		>Storage Media File-Set UID	(0088,0140)	Not used
Storage Commitment Request Complete - Failures Exist	2	Transaction UID	(0008,1195)	-/1
		Retrieve AE Title	(0008,0054)	Not used
		Storage Media File-Set ID	(0088,0130)	Not used
		Storage Media File-Set UID	(0088,0140)	Not used
		Referenced SOP Sequence	(0008,1199)	-/1C
		>Referenced SOP Class UID	(0008,1150)	-/1
		>Referenced SOP Instance UID	(0008,1155)	-/1
		>Retrieve AE Title	(0008,0054)	Not used
		>Storage Media File-Set ID	(0088,0130)	Not used
		>Storage Media File-Set UID	(0088,0140)	Not used
		Failed SOP Sequence	(0008,1198)	-/1

		>Referenced SOP Class UID	(0008,1150)	-/1
		>Referenced SOP Instance UID	(0008,1155)	-/1
		>Failure Reason	(0008,1197)	-/1

**9.2.4.2 Service Class User Behavior**

If a successful answer is received, the request will be removed without warning the user.

If a non-successful answer is received, the request will be left in the holding queue.

If no answer is received, the request will be removed without warning the user after two days.

**9.2.4.3 Status Codes**

No Service Class specific status values are defined for the N-EVENT-REPORT Service. See PS 3.7 for general response status code.

For this SOP class, all status codes with status Refused or Error are treated as failures and terminate the association and operation. All status codes with status Warning or Success are treated as successes.

## 10. PRINT MANAGEMENT SOP CLASS DEFINITION

### 10.1 INTRODUCTION

This section of the DICOM Conformance Statement specifies the supported Print Management SOP and Meta SOP Classes, the optional attributes and service elements supported, the valid range of values for mandatory and optional attributes, and the status code behavior.

10.2 - Basic Print Management Meta SOP Classes

10.3 - Print Management SOP Class Definitions

10.4 - Print Management IODs

10.5 - IOD Module Definition

### 10.2 BASIC PRINT MANAGEMENT META SOP CLASSES

The Basic Print Management Meta SOP Classes correspond with the minimum functionality that an implementation of the Print Management Service Class shall support.

EchoPAC PC supports the Basic Grayscale Print Management Meta SOP Class and the Basic Color Print Management Meta SOP Class. These are defined in Table 10.2.1-1 and Table 10.2.2-1.

#### 10.2.1 Basic Grayscale Print Management Meta SOP Class

The Basic Grayscale Print Management Meta SOP Class is defined by the following set of supported SOP Classes.

**TABLE 10.2.1-1 BASIC GRAYSCALE PRINT MANAGEMENT META SOP CLASS**

SOP Class Name	Usage SCU	Reference
Basic Film Session SOP Class	M	see 10.3.1
Basic Film Box SOP Class	M	see 10.3.2
Basic Grayscale Image Box SOP Class	M	see 10.3.3.1
Printer SOP Class	M	see 10.3.4

#### 10.2.2 Basic Color Print Management Meta SOP Class

The Basic Color Print Management Meta SOP Class is defined by the following set of supported SOP Classes

**TABLE 10.2.2-1 BASIC COLOR PRINT MANAGEMENT META SOP CLASS**

<b>SOP Class Name</b>	<b>Usage SCU</b>	<b>Reference</b>
Basic Film Session SOP Class	M	see 10.3.1
Basic Film Box SOP Class	M	see 10.3.2
Basic Color Image Box SOP Class	M	see 10.3.3.2
Printer SOP Class	M	see 10.3.4

**10.3 PRINT MANAGEMENT SOP CLASS DEFINITIONS**

**10.3.1 Basic Film Session SOP Class**

The Basic Film Session IOD describes the presentation parameters, which are common for all the films of a film session. The DIMSE services that are applicable to the IOD are shown in Table 10.3.1-1.

**TABLE 10.3.1-1 DIMSE SERVICE GROUP**

<b>DIMSE Service Element</b>	<b>Usage SCU</b>	<b>Reference</b>
N-CREATE	M	see 10.3.1.1.1
N-SET	U	see 10.3.1.1.2
N-DELETE	U	see 10.3.1.1.3
N-ACTION	U	see 10.3.1.1.4

**10.3.1.1 DIMSE Service Group**

**10.3.1.1.1 N-CREATE**

The N-CREATE DIMSE Service is used by EchoPAC PC to request that the SCP (printer) create a Film Session SOP Instance. Table 10.4.2-1 defines the Basic Film Session Presentation Module attributes used in this request.

**10.3.1.1.2 N-SET**

Not used in this implementation.

**10.3.1.1.3 N-DELETE**

Not used in this implementation.

**10.3.1.1.4 N-ACTION**

Not used in this implementation

**10.3.2 Basic Film Box SOP Class**

The Basic Film Box IOD is an abstraction of the presentation of one film of the film session. The DIMSE services that are applicable to the IOD are shown in Table 10.3.2-1.



**TABLE 10.3.2-1 DIMSE SERVICE GROUP**

<b>DIMSE Service Element</b>	<b>Usage SCU</b>	<b>Reference</b>
N-CREATE	M	see 10.3.2.1.1
N-ACTION	M	see 10.3.2.1.2
N-DELETE	U	see 10.3.2.1.3
N-SET	U	see 10.3.2.1.4

**10.3.2.1 DIMSE Service Group**

**10.3.2.1.1 N-CREATE**

The N-CREATE DIMSE Service is used by EchoPAC PC to request that the SCP create a Film Box SOP Instance. Table 10.4.2-1 defines the Basic Film Box Presentation Module attributes used in this request.

**10.3.2.1.2 N-ACTION**

The N-ACTION DIMSE Service is used by EchoPAC PC to request the SCP (printer) to print the number of copies configured by the user to a film of the film session.

**10.3.2.1.3 N-DELETE**

The N-DELETE DIMSE Service is used by EchoPAC PC to request the SCP (printer) to delete the complete Film Box. The root Film Box Instance UID is sent to the SCP to accomplish this.

**10.3.2.1.4 N-SET**

Not used in this implementation.

**10.3.3 Image Box SOP Class**

**10.3.3.1 Basic Grayscale Image Box SOP Class**

The Basic Grayscale Image Box IOD is an abstraction of the presentation of an image and image related data in the image area of a film. The DIMSE services that are applicable to the IOD are shown in Table 10.3.3-1.

**TABLE 10.3.3-1 DIMSE SERVICE GROUP**

<b>DIMSE Service Element</b>	<b>Usage SCU</b>	<b>Reference</b>
N-SET	M	see 10.3.3.1.1

**10.3.3.1.1 DIMSE Service Group (N-SET)**

The N-SET DIMSE Service is used by EchoPAC PC to update the Basic Grayscale Image Box SOP Instance. Table 10.5.2-5 defines the Basic Image Box Presentation Module attributes used.

**10.3.3.2 Basic Color Image Box SOP Class**

The Basic Color Image Box IOD is an abstraction of the presentation of an image and image related data in the image area of a film. The DIMSE services that are applicable to the IOD are shown in Table 10.3.3-2.

**TABLE 10.3.3-2 DIMSE SERVICE GROUP**

<b>DIMSE Service Element</b>	<b>Usage SCU</b>	<b>Reference</b>
N-SET	M	see 10.3.3.2.1

**10.3.3.2.1 DIMSE Service Group (N-SET)**

The N-SET DIMSE Service is used by EchoPAC PC to update the Basic Color Image Box SOP Instance. Table 10.5.2-5 defines the Basic Image Box Presentation Module attributes used.

**10.3.4 Printer SOP Class**

The Printer IOD is an abstraction of the hard copy printer and is the basic Information Entity to monitor the status of the printer. The DIMSE services that are applicable to the IOD are shown in table 11.3.4-1.

**10.3.4.1 DIMSE Service Group**

**TABLE 10.3.4-1 DIMSE SERVICE GROUP**

<b>DIMSE Service Element</b>	<b>Usage SCU</b>	<b>Reference</b>
N-EVENT-REPORT	M	see 10.3.4.1.1
N-GET	U	see 10.3.4.1.2

**10.3.4.1.1 N-EVENT\_REPORT**

EchoPAC PC confirms the N-EVENT-REPORT initiated by the SCP (printer).

**10.3.4.1.2 N-GET**

Used by EchoPAC PC to request the SCP to get a Printer SOP Instance. Table 10.5.2-6 defines the Printer Module attributes.

**10.4 PRINT MANAGEMENT IODS**

Within an entity of a DICOM Print Management, attributes are grouped into a related set of attributes. A set of related attributes is termed a module. A module facilitates the understanding of the semantics concerning the attributes and how the attributes are related with each other. A module grouping does not infer any encoding of information into datasets.

Table 10.4.1-1, Table 10.4.2-1, Table 10.4.3-1, and Table 10.4.4-1 identify the defined modules within the entities which comprise the DICOM Print Management Service IODs. Modules are identified by Module Name.

See DICOM for a complete definition of the entities, modules and attributes.

**10.4.1 Film Session IOD Module**

**TABLE 10.4.1-1 FILM SESSION IOD MODULES**

<b>Module Name</b>	<b>Reference</b>	<b>Module Description</b>
SOP Common Module	10.5.2.1	Contains SOP Common information
Basic Film Session Presentation Module	10.5.2.1	Contains Film Session presentation information
Basic Film Session Relationship Module	10.5.2.2	References to related SOPs

**10.4.2 Basic Film Box IOD Module Table**

**TABLE 10.4.2-1 BASIC FILM BOX IOD MODULES**

<b>Module Name</b>	<b>Reference</b>
SOP Common Module	10.5.1.1
Basic Film Box Presentation Module	10.5.2.3
Basic Film Box Relationship Module	10.5.2.2

**10.4.3 Basic Image Box IOD Module Table**

**TABLE 10.4.3-1 BASIC IMAGE BOX IOD MODULES**

<b>Module Name</b>	<b>Reference</b>
SOP Common Module	10.5.1.1
Image Box Pixel Presentation Module	10.5.2.5

**10.4.4 Printer IOD Module Table**

**TABLE 10.4.4-1 PRINTER IOD MODULES**

<b>Module Name</b>	<b>Reference</b>
SOP Common Module	10.5.1.1
Printer Module	10.5.2.6

**10.5 INFORMATION MODULE DEFINITIONS**

Please refer to DICOM Standard Part 3 (Information Object Definitions) for a description of each of the entities and modules that comprise the Print Management.

The following modules are included to convey Enumerated Values, Defined Terms, and Optional Attributes supported.

**10.5.1 General Modules**

**10.5.1.1 SOP Common Module**

This section defines the attributes that are required for proper functioning and identification of the associated SOP Instances. They do not specify any semantics about the Real-World Object represented by the IOD.

**TABLE 10.5.1-1 SOP COMMON MODULE ATTRIBUTES**

<b>Attribute Name</b>	<b>Tag</b>	<b>Type</b>	<b>Attribute Description</b>
SOP Class UID	(0008,0016)	1	Varies with Module Instance and DIMSE Service being used. 1.2.840.100011.5.1.1.1 (Film Session) 1.2.840.100011.5.1.1.2 (Film Box) 1.2.840.100011.5.1.1.4 (Image Box)
SOP Instance UID	(0008,0018)	1	Provided by SCP (printer).
Specific Character Set	(0008,0005)	1C	Not used as expanded or replacement character sets not used.
Instance Creation Date	(0008,0012)	3	Not used.
Instance Creation Time	(0008,0013)	3	Not used.
Instance Creator UID	(0008,0014)	3	Not used.

**10.5.2 Print Management Modules**

For all user configurable tags with no default, no value will be sent if the tag is not configured.

**10.5.2.1 Basic Film Session Presentation Module**

This section defines the attributes that are common for all films of a film session. The attributes described in table 11.5.2-1 apply when the N-CREATE DIMSE service is used.

**TABLE 10.5.2-1 BASIC FILM SESSION PRESENTATION MODULE ATTRIBUTES**

Attribute Name	Tag	USAGE (SCU)	Attribute Description
Number of Copies	(2000,0010)	U	Defined Terms used (user configurable): Default is 1. Max is 99.
Print Priority	(2000,0020)	U	Defined Terms used (user configurable): HIGH, MED, LOW. Default is HIGH.
Medium Type	(2000,0030)	U	Defined Terms used (user configurable): PAPER BLUE FILM CLEAR FILM Default is CLEAR FILM.
Film Destination	(2000,0040)	U	Defined Terms used (user configurable): MAGAZINE - default PROCESSOR
Film Session Label	(2000,0050)	U	User configurable. No default.
Memory Allocation	(2000,0060)	U	Not Used
Owner Id	(2100,0160)	U	Not Used

**10.5.2.2 Basic Film Session Relationship Module**

**TABLE 10.5.2-2 BASIC FILM SESSION RELATIONSHIP MODULE ATTRIBUTES**

Attribute Name	Tag	USAGE (SCU)	Attribute Description
Referenced Film Box Sequence	(2000,0500)	U	Not used
>Referenced SOP Class UID	(0008,1150)	U	
>Referenced SOP Instance UID	(0008,1155)	U	

**10.5.2.3 Basic Film Box Presentation Module**

The attributes described in table 11.5.2-3 apply when the N-CREATE DIMSE service is used.

TABLE 10.5.2-3 BASIC FILM BOX PRESENTATION MODULE ATTRIBUTES

Attribute Name	Tag	USAGE (SCU)	Attribute Description
Image Display Format	(2010,0010)	M	Enumerated values used (user configurable): STANDARD\X,Y, where X and Y can take values from 1 to 5. Default is STANDARD\1,1.
Annotation Display Format ID	(2010,0030)	U	Not used.
Film Orientation	(2010,0040)	U	Defined Terms used (user configurable): PORTRAIT - default LANDSCAPE
Film Size ID	(2000,0050)	U	Defined Terms used (user configurable): 8INX10IN - default 10INX12IN 10INX14IN 11INX14IN 14INX14IN 14INX17IN 24CMX24CM 24CMX30CM
Magnification Type	(2010,0060)	U	Defined Terms Used (user configurable): REPLICATE - default BILINEAR CUBIC NONE
Smoothing Type	(2010,0080)	U	Free form text entry field (user configurable) and only sent if Magnification Type is CUBIC. No default
Border Density	(2010,0100)	U	Defined Terms Used (user configurable): BLACK WHITE Default is BLACK.
Empty Image Density	(2010,0110)	U	Defined Terms Used (user configurable): BLACK WHITE Default is WHITE.
Min Density	(2010,0120)	U	User configurable. No default. Max is 999.

Max Density	(2010,0130)	U	User configurable. No default. Max is 999.
Trim	(2010,0140)	U	Enumerated Values Used (user configurable): YES NO Default is NO.
Configuration Information	(2010,0150)	U	User configurable. No default.

**10.5.2.4 Basic Film Box Relationship Module**

This section defines the attributes that describe the common parameters, which apply for all images on a given sheet of film.

**TABLE 10.5.2-4 BASIC FILM BOX RELATIONSHIP MODULE ATTRIBUTES**

Attribute Name	Tag	USAGE (SCU)	Attribute Description
Referenced Film Session Sequence	(2010,0500)	M	
>Referenced SOP Class UID	(0008,1150)	M	1.2.840.10008.5.1.1.1
>Referenced SOP Instance UID	(0008,1155)	M	Provided by SCP (printer)
Referenced Image Box Sequence	(2010,0510)	U	Used for the subsequent handling of Image Boxes
>Referenced SOP Class UID	(0008,1150)	U	
>Referenced SOP Instance UID	(0008,1155)	U	
Referenced Basic Annotation Sequence	(2010,0520)	U	Not used
>Referenced SOP Class UID	(0008,1150)	U	
>Referenced SOP Instance UID	(0008,1155)	U	

**10.5.2.5 Image Box Pixel Presentation Module**

The attributes described in table 11.5.2-5 apply when the DIMSE Service N-SET is used.

The first attributes in the table are used for both grayscale and color printing. The attributes within the sequences are used for each type of printing respectively.

**TABLE 10.5.2-5 IMAGE BOX PIXEL PRESENTATION MODULE ATTRIBUTES**

Attribute Name	Tag	USAGE (SCU)	Attribute Description
Image Position	(2020,0010)	M	Based on the image display format.
Polarity	(2020,0020)	U	Defined term, NORMAL
Requested Image Size	(2020,0030)	U	Not sent
Basic Grayscale Image Sequence	(2020,0110)	M	
>Samples Per Pixel	(0028,0002)	M	Value = '1'
>Photometric Interpretation	(0028,0004)	M	Defined Term MONOCHROME2 used
>Rows	(0028,0010)	M	Value depends on scanning mode and configuration setup.
>Columns	(0028,0011)	M	Value depends on scanning mode and configuration setup.
>Pixel Aspect Ratio	(0028,0034)	MC	Not used
>Bits Allocated	(0028,0100)	M	Value always = 0008H
>Bits Stored	(0028,0101)	M	Value always = 0008H
>High Bit	(0028,0102)	M	Value always = 0007H
>Pixel Representation	(0028,0103)	M	Defined Value '0' - unsigned integer
>Pixel Data	(7FE0,0010)	M	
Basic Color Image Sequence	(2020,0111)	M	
>Samples Per Pixel	(0028,0002)	M	Value = '3'
>Photometric Interpretation	(0028,0004)	M	Defined Term RGB used
>Rows	(0028,0010)	M	Value depends on scanning mode and configuration setup.
>Columns	(0028,0011)	M	Value depends on scanning mode and configuration setup.
>Pixel Aspect Ratio	(0028,0034)	MC	Not used
>Bits Allocated	(0028,0100)	M	Value always = 0008H
>Bits Stored	(0028,0101)	M	Value always = 0008H
>High Bit	(0028,0102)	M	Value always = 0007H
>Pixel Representation	(0028,0103)	M	Defined Value '0' - unsigned integer
>Pixel Data	(7FE0,0010)	M	
>Planar Configuration	(0028, 0006)	M	0001H, color-by-plane, when Basic Color Image Sequence is set

**10.5.2.6 Printer Module**

This section defines the attributes that are used to monitor the status of the printer. The attributes described in Table 10.5.2-6 apply when the DIMSE Service N-GET is used.



**TABLE 10.5.2-6 PRINTER MODULE ATTRIBUTES**

<b>Attribute Name</b>	<b>Tag</b>	<b>USAG E (SCU)</b>	<b>Attribute Description</b>
Printer Status	(2110,0010)	U	Used to check the status of the printer before a print operation is started.  If the status is different from NORMAL, the print operation is aborted, a message is displayed and the print files reside in the print buffer.
Printer Status Info	(2110,0020)	U	If return status is "FAILURE" an error message is displayed, and the print files resides in the print buffer.
Printer Name	(2110,0030)	U	Requested, but not used
Manufacturer	(0008,0070)	U	Requested, but not used
Manufacturer Model Name	(0008,1090)	U	Requested, but not used
Device Serial Number	(0018,1000)	U	Requested, but not used
Software Versions	(0018,1020)	U	Requested, but not used
Date Last Calibration	(0018,1200)	U	Requested, but not used
Last Calibration	(0018,1201)	U	Requested, but not used

## **11. STUDY ROOT QUERY/RETRIEVE INFORMATION MODEL DEFINITION**

### **11.1 INTRODUCTION**

This section specifies the use of the DICOM Study Root Query/Retrieve Model used to organize data and against which a Query/Retrieve will be performed. The contents of this section are:

11.2 - Information Model Description

11.3 - Information Model Entity-Relationship Model

11.4 - Information Model Keys

### **11.2 STUDY ROOT INFORMATION MODEL DESCRIPTION**

This section defines the implementation of Study Root Query/Retrieve Information Model.

### **11.3 STUDY ROOT INFORMATION MODEL ENTITY-RELATIONSHIP MODEL**

The Entity-Relationship diagram for the Study Root Information Model schema is shown in Illustration 11.3-1. In this figure, the following diagrammatic convention is established to represent the information organization :

- each entity is represented by a rectangular box
- each relationship is represented by a diamond shaped box.
- the fact that a relationship exists between two entities is depicted by lines connecting the corresponding entity boxes to the relationship boxes.

The relationships are fully defined with the maximum number of possible entities in the relationship shown. In other words, the relationship between Series and Image can have up to n Images per Series.

**ILLUSTRATION 11.3-1**  
**STUDY ROOT QUERY/RETRIEVE INFORMATION MODEL E/R DIAGRAM**

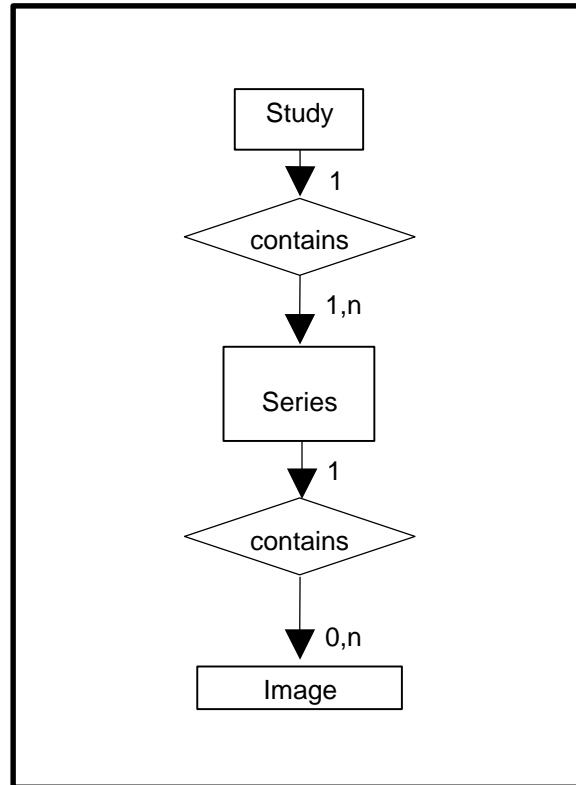

**11.3.1 Entity Descriptions**

Please refer to DICOM Standard PS 3.4 (Service Class Specifications) for a description of each of the levels contained within the Study Root Query/Retrieve Information Model.

**11.3.2 EchoPAC PC Mapping of DICOM entities**

**TABLE 11.3-1**  
**MAPPING OF DICOM ENTITIES TO ECHOPAC PC ENTITIES**

DICOM	EchoPAC PC Entity
Study	Exam
Series	Exam
Image	Image

**11.4 INFORMATION MODEL KEYS**

Please refer to DICOM Standard PS 3.4 (Service Class Specifications) for a description of each of the levels contained within the Study Root Query/Retrieve Information Model.

The following Level descriptions are included to specify what data elements are supported and what type of matching can be applied. It should be noted that they are the same ones as defined in the DICOM Standard PS 3.4 (Service Class Specifications).

**11.4.1 Supported Matching**

Following are the types of matching that can be requested by the implementation:

- Single Value matching
- List of UID matching
- Universal Matching
- Wild Card Matching
- Range of date, Range of Time
- Sequence Matching

Fields with “Filtering is supported” in the Matching column can be controlled from the Search screen. This means that the user can filter the downloaded C-FIND result, to view a limited set of the result.

All non-required matching fields can be configured in Config screen to be either enabled, enabled with a constant value or disabled. The constant value will be used as entered by user.

**11.4.2 Study Level**

This section defines the keys at the Study Level of the Study Root Query/Retrieve Information Model that are supported by this implementation.

**TABLE 11.4-2**  
**STUDY LEVEL ATTRIBUTES FOR THE STUDY ROOT**  
**QUERY/RETRIEVE INFORMATION MODEL**

<b>Attribute Name</b>	<b>Tag</b>	<b>Type</b>	<b>Attribute Description</b>
Study Date	(0008,0020)	R	Matching is supported. Filtering is supported.
Study Time	(0008,0030)	R	Matching is supported.
Accession Number	(0008,0050)	R	Matching is supported. Filtering is supported.
Patient's Name	(0010,0010)	R	Matching is supported. Filtering is supported.
Patient ID	(0010,0020)	R	Matching is supported. Filtering is supported.
Study ID	(0020,0010)	R	Matching is supported. Filtering is supported.
Study Instance UID	(0020,000D)	U	Matching is supported.
Modalities in Study	(0008,0061)	O	Matching is supported.
Referring Physician's Name	(0008,0090)	O	Matching is supported.
Study Description	(0008,1030)	O	Matching is supported.
Procedure Code Sequence	(0008,1032)	O	Matching is supported.
>Include 'Code Sequence Macro'			
Name of Physician(s) Reading Study	(0008,1060)	O	Matching is supported.
Admitting Diagnoses Description	(0008,1080)	O	Matching is supported.
Referenced Study Sequence	(0008,1110)	O	Matching is supported.
>Referenced SOP Class UID	(0008,1150)	O	Matching is supported.
>Referenced SOP Instance UID	(0008,1155)	O	Matching is supported.

Referenced Patient Sequence	(0008,1120)	O	Matching is supported.
>Referenced SOP Class UID	(0008,1150)	O	Matching is supported.
>Referenced SOP Instance UID	(0008,1155)	O	Matching is supported.
Patient's Birth Date	(0010,0030)	O	Matching is supported. Filtering is supported.
Patient's Birth Time	(0010,0032)	O	Matching is supported.
Patient's Sex	(0010,0040)	O	Matching is supported. Filtering is supported.
Other Patient IDs	(0010,1000)	O	Matching is supported. Filtering is supported.
Other Patient Names	(0010,1001)	O	Matching is supported.
Patient's Age	(0010,1010)	O	Matching is supported.
Patient's Size	(0010,1020)	O	Matching is supported.
Patient's Weight	(0010,1030)	O	Matching is supported.
Ethnic Group	(0010,2160)	O	Matching is supported.
Occupation	(0010,2180)	O	Matching is supported.
Additional Patient History	(0010,21B0)	O	Matching is supported.
Patient Comments	(0010,4000)	O	Matching is supported.
Other Study Numbers	(0020,1070)	O	Matching is supported.
Number of Patient Related Studies	(0020,1200)	O	Matching is supported.
Number of Patient Related Series	(0020,1202)	O	Matching is supported.
Number of Patient Related Instances	(0020,1204)	O	Matching is supported.
Number of Study Related Series	(0020,1206)	O	Matching is supported.
Number of Study Related Instances	(0020,1208)	O	Matching is supported.
Interpretation Author	(4008,010C)	O	Matching is supported.

**TABLE 11.4-3**  
**Q/R STUDY LEVEL AND LOCATION FOR RETRIEVE ATTRIBUTES**

Attribute Name	Tag	Type	Note
Query Retrieve Level	(0008,0052)	-	Value = STUDY

**TABLE 11.4-4**  
**Q/R SPECIFIC CHARACTER SET ATTRIBUTES**

Attribute Name	Tag	Type	Note
Specific Character Set	(0008,0005)	-	Set to "ISO_IR 100" if extended characters are used in query. ISO_IR 100 is supported in responses.

**11.4.3 Series Level**

This section defines the keys at the Series Level of the Study Root Query/Retrieve Information Model that are supported by this implementation.

**TABLE 11.4-5**  
**SERIES LEVEL ATTRIBUTES FOR THE STUDY ROOT**  
**QUERY/RETRIEVE INFORMATION MODEL**

Attribute Name	Tag	Type	Attribute Description
Modality	(0008,0060)	R	Matching is supported.
Series Number	(0020,0011)	R	Matching is supported.
Series Instance UID	(0020,000E)	U	Matching is supported.
Number of Series Related Instances	(0020,1209)	O	Matching is supported.
Series Date	(0008,0021)	O	Matching is supported.
Series Time	(0008,0031)	O	Matching is supported.
Performing Physicians' Name	(0008,1050)	O	Matching is supported.
Protocol Name	(0018,1030)	O	Matching is supported.
Series Description	(0008,103E)	O	Matching is supported.
Operator's Name	(0008,1070)	O	Matching is supported.
Institutional Department Name	(0008,1040)	O	Matching is supported.
Software Versions	(0018,1020)	O	Matching is supported.
Performed Procedure Step Start Date	(0040,0244)	O	Matching is supported.
Performed Procedure Step Start Time	(0040,0245)	O	Matching is supported.
Request Attributes Sequence	(0040,0275)	O	Matching is supported.

**TABLE 11.4-6**  
**Q/R SERIES LEVEL AND LOCATION FOR RETRIEVE ATTRIBUTES**

Attribute Name	Tag	Type	Note
Query Retrieve Level	(0008,0052)	-	Value = SERIES

**TABLE 11.4-7**  
**Q/R SPECIFIC CHARACTER SET ATTRIBUTES**

Attribute Name	Tag	Type	Note
Specific Character Set	(0008,0005)	-	Set to "ISO_IR 100" if extended characters are used in query. ISO_IR 100 is supported in responses.

**11.4.4 Image Level**

This section defines the keys at the Image Level of the Study Root Query/Retrieve Information Model that are supported by this implementation.

**TABLE 11.4-8**  
**IMAGE LEVEL ATTRIBUTES FOR THE STUDY ROOT**  
**QUERY/RETRIEVE INFORMATION MODEL**

Attribute Name	Tag	Type	Attribute Description
Instance Number	(0020,0013)	R	Matching is supported.

SOP Instance UID	(0008,0018)	U	Matching is supported.
Contrast/Bolus Agent	(0018,0010)	O	Matching is supported.

**TABLE 11.4-9**  
**Q/R IMAGE LEVEL AND LOCATION FOR RETRIEVE ATTRIBUTES**

Attribute Name	Tag	Type	Note
Query Retrieve Level	(0008,0052)	-	Value = IMAGE

**TABLE 11.4-10**  
**Q/R SPECIFIC CHARACTER SET ATTRIBUTES**

Attribute Name	Tag	Type	Note
Specific Character Set	(0008,0005)	-	Set to "ISO_IR 100" if extended characters are used in query. ISO_IR 100 is supported in responses.

**11.5 PRIVATE DATA DICTIONARY**

No private data dictionary is defined.

## 12. ECHOCARDIOGRAPHY PROCEDURE REPORT

This table maps the product’s internal parameter ids (each parameter id has a corresponding alias which is the parameter name displayed in the product’s user interface) and in some cases the mode to:

(Anatomy) Section, Base Measurement and Modifiers in Echocardiography Procedure Report (TID 5200) SR. The parameters are grouped by Section.

Note: If “Use older SR version” is enabled (see 2.6, 3.6 and 7) the corresponding mapping table present in the DICOM Conformance Statement of the selected version should be used.

### Section Left Ventricle

<b>GEU Parameter ID (and corresponding alias)</b>	<b>Base Measurement Concept Name</b>	<b>Concept or Acquisition Context Modifier</b>
<b>GPSL(4D)</b> <b>Alias: GPSL</b>	<b>(GEU-106-0001, 99GEMS, "Global Peak Longitudinal Strain")</b>	<b>(G-0373, SRT, "Image Mode") = (125231, DCM, "3D mode")</b>
<b>LVd Mass(4D)</b> <b>Alias: EDMass</b>	<b>(18087-7, LN, "Left Ventricle Mass")</b>	<b>(G-0373, SRT, "Image Mode") = (125231, DCM, "3D mode") (R-4089A, SRT, "Cardiac Cycle Point") = (F-32010, SRT, "Diastole") (G-C036, SRT, "Measurement Method") = (GEU-106-0023, 99GEMS, "4D Auto Left Ventricle Quantification")</b>
<b>LVs Mass(4D)</b> <b>Alias: ESMass</b>	<b>(18087-7, LN, "Left Ventricle Mass")</b>	<b>(G-0373, SRT, "Image Mode") = (125231, DCM, "3D mode") (R-4089A, SRT, "Cardiac Cycle Point") = (F-32020, SRT, "Systole") (G-C036, SRT, "Measurement Method") = (GEU-106-0023, 99GEMS, "4D Auto Left Ventricle Quantification")</b>
<b>Auto2DEF/HR_2Ch_Q</b> <b>Alias: HR_2Ch_Q</b>	<b>(8867-4, LN, "Heart rate")</b>	<b>(111031, DCM, "Image View") = (G-A19B, SRT, "Apical two chamber") (G-C036, SRT, "Measurement Method") = (GEU-106-0019, 99GEMS, "2D Auto EF")</b>



<p><b>Auto2DEF/LVVED_2Ch_Q</b>  <b>Alias: LVVED_2Ch_Q</b></p>	<p><b>(18026-5, LN, "Left Ventricular End Diastolic Volume")</b></p>	<p><b>(111031, DCM, "Image View") = (G-A19B, SRT, "Apical two chamber")</b>  <b>(G-C036, SRT, "Measurement Method") = (GEU-106-0019, 99GEMS, "2D Auto EF")</b></p>
<p><b>Auto2DEF/LVVES_2Ch_Q</b>  <b>Alias: LVVES_2Ch_Q</b></p>	<p><b>(18148-7, LN, "Left Ventricular End Systolic Volume")</b></p>	<p><b>(111031, DCM, "Image View") = (G-A19B, SRT, "Apical two chamber")</b>  <b>(G-C036, SRT, "Measurement Method") = (GEU-106-0019, 99GEMS, "2D Auto EF")</b></p>
<p><b>Auto2DEF/LVEF_2Ch_Q</b>  <b>Alias: LVEF_2Ch_Q</b></p>	<p><b>(18043-0, LN, "Left Ventricular Ejection Fraction")</b></p>	<p><b>(111031, DCM, "Image View") = (G-A19B, SRT, "Apical two chamber")</b>  <b>(G-C036, SRT, "Measurement Method") = (GEU-106-0019, 99GEMS, "2D Auto EF")</b></p>
<p><b>Auto2DEF/LVSV_2Ch_Q</b>  <b>Alias: LVSV_2Ch_Q</b></p>	<p><b>(F-32120, SRT, "Stroke Volume")</b></p>	<p><b>(111031, DCM, "Image View") = (G-A19B, SRT, "Apical two chamber")</b>  <b>(G-C036, SRT, "Measurement Method") = (GEU-106-0019, 99GEMS, "2D Auto EF")</b></p>
<p><b>Auto2DEF/LVCO_2Ch_Q</b>  <b>Alias: LVCO_2Ch_Q</b></p>	<p><b>(F-32100, SRT, "Cardiac Output")</b></p>	<p><b>(111031, DCM, "Image View") = (G-A19B, SRT, "Apical two chamber")</b>  <b>(G-C036, SRT, "Measurement Method") = (GEU-106-0019, 99GEMS, "2D Auto EF")</b></p>
<p><b>Auto2DEF/LVLs_2Ch_Q</b>  <b>Alias: LVLs_2Ch_Q</b></p>	<p><b>(18073-7, LN, "Left Ventricular Major Axis Systolic Dimension, 2-chamber view")</b></p>	<p><b>(G-C036, SRT, "Measurement Method") = (GEU-106-0019, 99GEMS, "2D Auto EF")</b></p>
<p><b>Auto2DEF/LVLd_2Ch_Q</b>  <b>Alias: LVLd_2Ch_Q</b></p>	<p><b>(18072-9, LN, "Left Ventricular Major Axis Diastolic Dimension, 2-chamber view")</b></p>	<p><b>(G-C036, SRT, "Measurement Method") = (GEU-106-0019, 99GEMS, "2D Auto EF")</b></p>
<p><b>Auto2DEF/HR_4Ch_Q</b>  <b>Alias: HR_4Ch_Q</b></p>	<p><b>(8867-4, LN, "Heart rate")</b></p>	<p><b>(111031, DCM, "Image View") = (G-A19C, SRT, "Apical four chamber")</b>  <b>(G-C036, SRT, "Measurement Method") = (GEU-106-0019, 99GEMS, "2D Auto EF")</b></p>

		99GEMS, "2D Auto EF")
Auto2DEF/LVVED_4Ch_Q Alias: LVVED_4Ch_Q	(18026-5, LN, "Left Ventricular End Diastolic Volume")	(111031, DCM, "Image View") = (G-A19C, SRT, "Apical four chamber") (G-C036, SRT, "Measurement Method") = (GEU-106-0019, 99GEMS, "2D Auto EF")
Auto2DEF/LVVES_4Ch_Q Alias: LVVES_4Ch_Q	(18148-7, LN, "Left Ventricular End Systolic Volume")	(111031, DCM, "Image View") = (G-A19C, SRT, "Apical four chamber") (G-C036, SRT, "Measurement Method") = (GEU-106-0019, 99GEMS, "2D Auto EF")
Auto2DEF/LVEF_4Ch_Q Alias: LVEF_4Ch_Q	(18043-0, LN, "Left Ventricular Ejection Fraction")	(111031, DCM, "Image View") = (G-A19C, SRT, "Apical four chamber") (G-C036, SRT, "Measurement Method") = (GEU-106-0019, 99GEMS, "2D Auto EF")
Auto2DEF/LVSV_4Ch_Q Alias: LVSV_4Ch_Q	(F-32120, SRT, "Stroke Volume")	(111031, DCM, "Image View") = (G-A19C, SRT, "Apical four chamber") (G-C036, SRT, "Measurement Method") = (GEU-106-0019, 99GEMS, "2D Auto EF")
Auto2DEF/LVCO_4Ch_Q Alias: LVCO_4Ch_Q	(F-32100, SRT, "Cardiac Output")	(111031, DCM, "Image View") = (G-A19C, SRT, "Apical four chamber") (G-C036, SRT, "Measurement Method") = (GEU-106-0019, 99GEMS, "2D Auto EF")
Auto2DEF/LVLs_4Ch_Q Alias: LVLs_4Ch_Q	(18075-2, LN, "Left Ventricular Major Axis Systolic Dimension, 4-chamber view")	(G-C036, SRT, "Measurement Method") = (GEU-106-0019, 99GEMS, "2D Auto EF")
Auto2DEF/LVLd_4Ch_Q Alias: LVLd_4Ch_Q	(18074-5, LN, "Left Ventricular Major Axis Diastolic Dimension, 4-chamber view")	(G-C036, SRT, "Measurement Method") = (GEU-106-0019, 99GEMS, "2D Auto EF")
Auto2DEF/LVVED_BiP_Q Alias: LVVED_BiP_Q	(18026-5, LN, "Left Ventricular End Diastolic Volume")	(G-C036, SRT, "Measurement Method") = (GEU-106-0019, 99GEMS, "2D Auto EF")

Auto2DEF/LVVES_BiP_Q Alias: LVVES_BiP_Q	(18148-7, LN, "Left Ventricular End Systolic Volume")	(G-C036, SRT, "Measurement Method") = (GEU-106-0019, 99GEMS, "2D Auto EF")
Auto2DEF/LVEF_BiP_Q Alias: LVEF_BiP_Q	(18043-0, LN, "Left Ventricular Ejection Fraction")	(G-C036, SRT, "Measurement Method") = (GEU-106-0019, 99GEMS, "2D Auto EF")
Auto2DEF/LVSV_BiP_Q Alias: LVSV_BiP_Q	(F-32120, SRT, "Stroke Volume")	(G-C036, SRT, "Measurement Method") = (GEU-106-0019, 99GEMS, "2D Auto EF")
Auto2DEF/LVCO_BiP_Q Alias: LVCO_BiP_Q	(F-32100, SRT, "Cardiac Output")	(G-C036, SRT, "Measurement Method") = (GEU-106-0019, 99GEMS, "2D Auto EF")
TomTec/LVFunction/EDV Alias: LVEDV(TomTec)	(18026-5, LN, "Left Ventricular End Diastolic Volume")	(G-C036, SRT, "Measurement Method") = (GEU-106-0021, 99GEMS, "4D Left Ventricle Volume")
TomTec/LVFunction/ESV Alias: LVESV(TomTec)	(18148-7, LN, "Left Ventricular End Systolic Volume")	(G-C036, SRT, "Measurement Method") = (GEU-106-0021, 99GEMS, "4D Left Ventricle Volume")
TomTec/LVFunction/SV Alias: SV(TomTec)	(F-32120, SRT, "Stroke Volume")	(G-C036, SRT, "Measurement Method") = (GEU-106-0021, 99GEMS, "4D Left Ventricle Volume")
TomTec/LVFunction/EF Alias: EF(TomTec)	(18043-0, LN, "Left Ventricular Ejection Fraction")	(G-C036, SRT, "Measurement Method") = (GEU-106-0021, 99GEMS, "4D Left Ventricle Volume")
TomTec/LVFunction/SDI16 Alias: SDI16(TomTec)	(GEU-106-0016, 99GEMS, "Systolic Dyssynchrony Index")	(G-C036, SRT, "Measurement Method") = (GEU-106-0021, 99GEMS, "4D Left Ventricle Volume")
LVLad(apical) Alias: TEa(d)	(G-0377, SRT, "Left Ventricle Semi-major Axis Diastolic Dimension")	
LVLdd(apical) Alias: TEd(d)	(G-0378, SRT, "Left Ventricle Truncated Semi-major Axis Diastolic")	

	Dimension")	
<b>LVd Mass(TE)</b> Alias: LVd Mass TE	(18087-7, LN, "Left Ventricle Mass")	(R-4089A, SRT, "Cardiac Cycle Point") = (F-32010, SRT, "Diastole") (G-C036, SRT, "Measurement Method") = (125222, DCM, "Left Ventricle Mass Truncated Ellipse")
<b>LVd Mass Index(TE)</b> Alias: LVd Mass Ind TE	(GEU-106-0028, 99GEMS, "Left Ventricle Mass Index")	(R-4089A, SRT, "Cardiac Cycle Point") = (F-32010, SRT, "Diastole") (G-C036, SRT, "Measurement Method") = (125222, DCM, "Left Ventricle Mass Truncated Ellipse")
<b>LVs Mass(TE)</b> Alias: LVs Mass TE	(18087-7, LN, "Left Ventricle Mass")	(R-4089A, SRT, "Cardiac Cycle Point") = (F-32020, SRT, "Systole") (G-C036, SRT, "Measurement Method") = (125222, DCM, "Left Ventricle Mass Truncated Ellipse")
<b>LVLd(avg)</b> Alias: LVLd(avg)	(18077-8, LN, "Left Ventricle diastolic major axis")	(G-C036, SRT, "Measurement Method") = (GEU-106-0017, 99GEMS, "Triplane")
<b>LVEDV(Geom)</b> Alias: LVEDV(Geom)	(18026-5, LN, "Left Ventricular End Diastolic Volume")	(G-C036, SRT, "Measurement Method") = (GEU-106-0017, 99GEMS, "Triplane")
<b>LVLs(avg)</b> Alias: LVLs(avg)	(18076-0, LN, "Left Ventricle systolic major axis")	(G-C036, SRT, "Measurement Method") = (GEU-106-0017, 99GEMS, "Triplane")
<b>LVESV(Geom)</b> Alias: LVESV(Geom)	(18148-7, LN, "Left Ventricular End Systolic Volume")	(G-C036, SRT, "Measurement Method") = (GEU-106-0017, 99GEMS, "Triplane")
<b>EF(Geom)</b> Alias: EF(Geom)	(18043-0, LN, "Left Ventricular Ejection Fraction")	(G-C036, SRT, "Measurement Method") = (GEU-106-0017, 99GEMS, "Triplane")
<b>SV(Geom)</b> Alias: SV(Geom)	(F-32120, SRT, "Stroke Volume")	(G-C036, SRT, "Measurement Method") = (GEU-106-0017, 99GEMS, "Triplane")
<b>CO(Geom)</b> Alias: CO(Geom)	(F-32100, SRT, "Cardiac Output")	(G-C036, SRT, "Measurement Method") = (GEU-106-0017, 99GEMS, "Triplane")

<p><b>TSI/BS PeakVel</b> Alias: BS PeakVel</p>	<p>(11726-7, LN, "Peak Velocity")</p>	<p>(G-C0E3, SRT, "Finding Site") = (R-10076, SRT, "left ventricle basal inferoseptal segment") (G-0373, SRT, "Image Mode") = (GEU-106-0024, 99GEMS, "Tissue Doppler Imaging") (G-C036, SRT, "Measurement Method") = (GEU-106-0020, 99GEMS, "Tissue Synchronization Imaging")</p>
<p><b>TSI/BS TimeToPeak</b> Alias: BS TimeToPeak</p>	<p>(GEU-106-0006, 99GEMS, "Time To Peak")</p>	<p>(G-C0E3, SRT, "Finding Site") = (R-10076, SRT, "left ventricle basal inferoseptal segment") (G-0373, SRT, "Image Mode") = (GEU-106-0024, 99GEMS, "Tissue Doppler Imaging") (G-C036, SRT, "Measurement Method") = (GEU-106-0020, 99GEMS, "Tissue Synchronization Imaging")</p>
<p><b>TSI/MS PeakVel</b> Alias: MS PeakVel</p>	<p>(11726-7, LN, "Peak Velocity")</p>	<p>(G-C0E3, SRT, "Finding Site") = (R-10078, SRT, "left ventricle mid inferoseptal segment") (G-0373, SRT, "Image Mode") = (GEU-106-0024, 99GEMS, "Tissue Doppler Imaging") (G-C036, SRT, "Measurement Method") = (GEU-106-0020, 99GEMS, "Tissue Synchronization Imaging")</p>
<p><b>TSI/MS TimeToPeak</b> Alias: MS TimeToPeak</p>	<p>(GEU-106-0006, 99GEMS, "Time To Peak")</p>	<p>(G-C0E3, SRT, "Finding Site") = (R-10078, SRT, "left ventricle mid inferoseptal segment") (G-0373, SRT, "Image Mode") = (GEU-106-0024, 99GEMS, "Tissue Doppler Imaging") (G-C036, SRT, "Measurement Method") = (GEU-106-0020, 99GEMS, "Tissue Synchronization Imaging")</p>
<p><b>TSI/ML PeakVel</b> Alias: ML PeakVel</p>	<p>(11726-7, LN, "Peak Velocity")</p>	<p>(G-C0E3, SRT, "Finding Site") = (R-1007C, SRT, "left ventricle mid anterolateral segment") (G-0373, SRT, "Image Mode") = (GEU-106-0024, 99GEMS, "Tissue Doppler Imaging") (G-C036, SRT, "Measurement Method") = (GEU-106-0020, 99GEMS, "Tissue Synchronization Imaging")</p>

		99GEMS, "Tissue Synchronization Imaging")
<p><b>TSI/ML TimeToPeak</b> Alias: ML TimeToPeak</p>	<p>(GEU-106-0006, 99GEMS, "Time To Peak")</p>	<p>(G-C0E3, SRT, "Finding Site") = (R-1007C, SRT, "left ventricle mid anterolateral segment") (G-0373, SRT, "Image Mode") = (GEU-106-0024, 99GEMS, "Tissue Doppler Imaging") (G-C036, SRT, "Measurement Method") = (GEU-106-0020, 99GEMS, "Tissue Synchronization Imaging")</p>
<p><b>TSI/BL PeakVel</b> Alias: BL PeakVel</p>	<p>(11726-7, LN, "Peak Velocity")</p>	<p>(G-C0E3, SRT, "Finding Site") = (R-1007A, SRT, "left ventricle basal anterolateral segment") (G-0373, SRT, "Image Mode") = (GEU-106-0024, 99GEMS, "Tissue Doppler Imaging") (G-C036, SRT, "Measurement Method") = (GEU-106-0020, 99GEMS, "Tissue Synchronization Imaging")</p>
<p><b>TSI/BL TimeToPeak</b> Alias: BL TimeToPeak</p>	<p>(GEU-106-0006, 99GEMS, "Time To Peak")</p>	<p>(G-C0E3, SRT, "Finding Site") = (R-1007A, SRT, "left ventricle basal anterolateral segment") (G-0373, SRT, "Image Mode") = (GEU-106-0024, 99GEMS, "Tissue Doppler Imaging") (G-C036, SRT, "Measurement Method") = (GEU-106-0020, 99GEMS, "Tissue Synchronization Imaging")</p>
<p><b>TSI/BI PeakVel</b> Alias: BI PeakVel</p>	<p>(11726-7, LN, "Peak Velocity")</p>	<p>(G-C0E3, SRT, "Finding Site") = (T-32615, SRT, "left ventricle basal inferior segment") (G-0373, SRT, "Image Mode") = (GEU-106-0024, 99GEMS, "Tissue Doppler Imaging") (G-C036, SRT, "Measurement Method") = (GEU-106-0020, 99GEMS, "Tissue Synchronization Imaging")</p>
<p><b>TSI/BI TimeToPeak</b> Alias: BI TimeToPeak</p>	<p>(GEU-106-0006, 99GEMS, "Time To Peak")</p>	<p>(G-C0E3, SRT, "Finding Site") = (T-32615, SRT, "left ventricle basal inferior segment") (G-0373, SRT, "Image Mode") = (GEU-106-0024, 99GEMS, "Tissue</p>

		Doppler Imaging") (G-C036, SRT, "Measurement Method") = (GEU-106-0020, 99GEMS, "Tissue Synchronization Imaging")
<b>TSI/MI PeakVel</b> Alias: MI PeakVel	(11726-7, LN, "Peak Velocity")	(G-C0E3, SRT, "Finding Site") = (T-32616, SRT, "left ventricle mid inferior segment") (G-0373, SRT, "Image Mode") = (GEU-106-0024, 99GEMS, "Tissue Doppler Imaging") (G-C036, SRT, "Measurement Method") = (GEU-106-0020, 99GEMS, "Tissue Synchronization Imaging")
<b>TSI/MI TimeToPeak</b> Alias: MI TimeToPeak	(GEU-106-0006, 99GEMS, "Time To Peak")	(G-C0E3, SRT, "Finding Site") = (T-32616, SRT, "left ventricle mid inferior segment") (G-0373, SRT, "Image Mode") = (GEU-106-0024, 99GEMS, "Tissue Doppler Imaging") (G-C036, SRT, "Measurement Method") = (GEU-106-0020, 99GEMS, "Tissue Synchronization Imaging")
<b>TSI/MA PeakVel</b> Alias: MA PeakVel	(11726-7, LN, "Peak Velocity")	(G-C0E3, SRT, "Finding Site") = (T-32617, SRT, "left ventricle mid anterior segment") (G-0373, SRT, "Image Mode") = (GEU-106-0024, 99GEMS, "Tissue Doppler Imaging") (G-C036, SRT, "Measurement Method") = (GEU-106-0020, 99GEMS, "Tissue Synchronization Imaging")
<b>TSI/MA TimeToPeak</b> Alias: MA TimeToPeak	(GEU-106-0006, 99GEMS, "Time To Peak")	(G-C0E3, SRT, "Finding Site") = (T-32617, SRT, "left ventricle mid anterior segment") (G-0373, SRT, "Image Mode") = (GEU-106-0024, 99GEMS, "Tissue Doppler Imaging") (G-C036, SRT, "Measurement Method") = (GEU-106-0020, 99GEMS, "Tissue Synchronization Imaging")
<b>TSI/BA PeakVel</b>	(11726-7, LN, "Peak	(G-C0E3, SRT, "Finding Site") = (T-32619, SRT, "left ventricle basal

<p><b>Alias: BA PeakVel</b></p>	<p><b>Velocity")</b></p>	<p>anterior segment")                  (G-0373, SRT, "Image Mode") =                  (GEU-106-0024, 99GEMS, "Tissue                  Doppler Imaging")                  (G-C036, SRT, "Measurement                  Method") = (GEU-106-0020,                  99GEMS, "Tissue Synchronization                  Imaging")</p>
<p><b>TSI/BA TimeToPeak</b>   <b>Alias: BA TimeToPeak</b></p>	<p><b>(GEU-106-0006, 99GEMS,                  "Time To Peak")</b></p>	<p>(G-C0E3, SRT, "Finding Site") =                  (T-32619, SRT, "left ventricle basal                  anterior segment")                  (G-0373, SRT, "Image Mode") =                  (GEU-106-0024, 99GEMS, "Tissue                  Doppler Imaging")                  (G-C036, SRT, "Measurement                  Method") = (GEU-106-0020,                  99GEMS, "Tissue Synchronization                  Imaging")</p>
<p><b>TSI/BP PeakVel</b>   <b>Alias: BP PeakVel</b></p>	<p><b>(11726-7, LN, "Peak                  Velocity")</b></p>	<p>(G-C0E3, SRT, "Finding Site") =                  (R-10079, SRT, "left ventricle basal                  inferolateral segment")                  (G-0373, SRT, "Image Mode") =                  (GEU-106-0024, 99GEMS, "Tissue                  Doppler Imaging")                  (G-C036, SRT, "Measurement                  Method") = (GEU-106-0020,                  99GEMS, "Tissue Synchronization                  Imaging")</p>
<p><b>TSI/BP TimeToPeak</b>   <b>Alias: BP TimeToPeak</b></p>	<p><b>(GEU-106-0006, 99GEMS,                  "Time To Peak")</b></p>	<p>(G-C0E3, SRT, "Finding Site") =                  (R-10079, SRT, "left ventricle basal                  inferolateral segment")                  (G-0373, SRT, "Image Mode") =                  (GEU-106-0024, 99GEMS, "Tissue                  Doppler Imaging")                  (G-C036, SRT, "Measurement                  Method") = (GEU-106-0020,                  99GEMS, "Tissue Synchronization                  Imaging")</p>
<p><b>TSI/MP PeakVel</b>   <b>Alias: MP PeakVel</b></p>	<p><b>(11726-7, LN, "Peak                  Velocity")</b></p>	<p>(G-C0E3, SRT, "Finding Site") =                  (R-1007B, SRT, "left ventricle mid                  inferolateral segment")                  (G-0373, SRT, "Image Mode") =                  (GEU-106-0024, 99GEMS, "Tissue                  Doppler Imaging")                  (G-C036, SRT, "Measurement                  Method") = (GEU-106-0020,                  99GEMS, "Tissue Synchronization                  Imaging")</p>



		Imaging")
<p><b>TSI/MP TimeToPeak</b> Alias: MP TimeToPeak</p>	<p>(GEU-106-0006, 99GEMS, "Time To Peak")</p>	<p>(G-C0E3, SRT, "Finding Site") = (R-1007B, SRT, "left ventricle mid inferolateral segment") (G-0373, SRT, "Image Mode") = (GEU-106-0024, 99GEMS, "Tissue Doppler Imaging") (G-C036, SRT, "Measurement Method") = (GEU-106-0020, 99GEMS, "Tissue Synchronization Imaging")</p>
<p><b>TSI/MAS PeakVel</b> Alias: MAS PeakVel</p>	<p>(11726-7, LN, "Peak Velocity")</p>	<p>(G-C0E3, SRT, "Finding Site") = (R-10077, SRT, "left ventricle mid anteroseptal segment") (G-0373, SRT, "Image Mode") = (GEU-106-0024, 99GEMS, "Tissue Doppler Imaging") (G-C036, SRT, "Measurement Method") = (GEU-106-0020, 99GEMS, "Tissue Synchronization Imaging")</p>
<p><b>TSI/MAS TimeToPeak</b> Alias: MAS TimeToPeak</p>	<p>(GEU-106-0006, 99GEMS, "Time To Peak")</p>	<p>(G-C0E3, SRT, "Finding Site") = (R-10077, SRT, "left ventricle mid anteroseptal segment") (G-0373, SRT, "Image Mode") = (GEU-106-0024, 99GEMS, "Tissue Doppler Imaging") (G-C036, SRT, "Measurement Method") = (GEU-106-0020, 99GEMS, "Tissue Synchronization Imaging")</p>
<p><b>TSI/BAS PeakVel</b> Alias: BAS PeakVel</p>	<p>(11726-7, LN, "Peak Velocity")</p>	<p>(G-C0E3, SRT, "Finding Site") = (R-10075, SRT, "left ventricle basal anteroseptal segment") (G-0373, SRT, "Image Mode") = (GEU-106-0024, 99GEMS, "Tissue Doppler Imaging") (G-C036, SRT, "Measurement Method") = (GEU-106-0020, 99GEMS, "Tissue Synchronization Imaging")</p>
<p><b>TSI/BAS TimeToPeak</b> Alias: BAS TimeToPeak</p>	<p>(GEU-106-0006, 99GEMS, "Time To Peak")</p>	<p>(G-C0E3, SRT, "Finding Site") = (R-10075, SRT, "left ventricle basal anteroseptal segment") (G-0373, SRT, "Image Mode") = (GEU-106-0024, 99GEMS, "Tissue Doppler Imaging")</p>

		(G-C036, SRT, "Measurement Method") = (GEU-106-0020, 99GEMS, "Tissue Synchronization Imaging")
<b>TSI/BL minus BS</b> Alias: Septal Lat delay	(GEU-106-0007, 99GEMS, "Septal Lateral Delay")	(G-0373, SRT, "Image Mode") = (GEU-106-0024, 99GEMS, "Tissue Doppler Imaging") (G-C036, SRT, "Measurement Method") = (GEU-106-0020, 99GEMS, "Tissue Synchronization Imaging")
<b>TSI/BP minus BAS</b> Alias: Septal Post delay	(GEU-106-0008, 99GEMS, "Septal Posterior Delay")	(G-0373, SRT, "Image Mode") = (GEU-106-0024, 99GEMS, "Tissue Doppler Imaging") (G-C036, SRT, "Measurement Method") = (GEU-106-0020, 99GEMS, "Tissue Synchronization Imaging")
<b>TSI/Basal max delay</b> Alias: Basal seg. max diff	(GEU-106-0009, 99GEMS, "Basal Segments Maximum Difference")	(G-0373, SRT, "Image Mode") = (GEU-106-0024, 99GEMS, "Tissue Doppler Imaging") (G-C036, SRT, "Measurement Method") = (GEU-106-0020, 99GEMS, "Tissue Synchronization Imaging")
<b>TSI/Basal stdev</b> Alias: Basal stdev	(GEU-106-0010, 99GEMS, "Basal Standard Deviation")	(G-0373, SRT, "Image Mode") = (GEU-106-0024, 99GEMS, "Tissue Doppler Imaging") (G-C036, SRT, "Measurement Method") = (GEU-106-0020, 99GEMS, "Tissue Synchronization Imaging")
<b>TSI/All segments max delay</b> Alias: All seg. max diff.	(GEU-106-0012, 99GEMS, "All Segments Maximum Difference")	(G-0373, SRT, "Image Mode") = (GEU-106-0024, 99GEMS, "Tissue Doppler Imaging") (G-C036, SRT, "Measurement Method") = (GEU-106-0020, 99GEMS, "Tissue Synchronization Imaging")
<b>TSI/All segments stdev</b> Alias: All segments stdev	(GEU-106-0012, 99GEMS, "All Segments Standard Deviation")	(G-0373, SRT, "Image Mode") = (GEU-106-0024, 99GEMS, "Tissue Doppler Imaging") (G-C036, SRT, "Measurement Method") = (GEU-106-0020, 99GEMS, "Tissue Synchronization Imaging")

		<b>Imaging")</b>
<b>CO(A-L)</b> <b>Alias: CO(A-L)</b>	<b>(F-32100, SRT, "Cardiac Output")</b>	<b>(G-C0E3, SRT, "Finding Site") = (T-32600, SRT, "Left Ventricle") (G-C036, SRT, "Measurement Method") = (125205, DCM, "Area-Length Single Plane")</b>
<b>CO(A-L A4C)/AutoHR</b> <b>Alias: CO A-L A4C</b>	<b>(F-32100, SRT, "Cardiac Output")</b>	<b>(G-C0E3, SRT, "Finding Site") = (T-32600, SRT, "Left Ventricle") (111031, DCM, "Image View") = (G-A19C, SRT, "Apical four chamber") (G-C036, SRT, "Measurement Method") = (125205, DCM, "Area-Length Single Plane")</b>
<b>CI(A-L A4C)/AutoHR</b> <b>Alias: CI A-L A4C</b>	<b>(F-32110, SRT, "Cardiac Index")</b>	<b>(G-C0E3, SRT, "Finding Site") = (T-32600, SRT, "Left Ventricle") (111031, DCM, "Image View") = (G-A19C, SRT, "Apical four chamber") (G-C036, SRT, "Measurement Method") = (125205, DCM, "Area-Length Single Plane")</b>
<b>CO(MOD A4C)/AutoHR</b> <b>Alias: CO MOD A4C</b>	<b>(F-32100, SRT, "Cardiac Output")</b>	<b>(G-C0E3, SRT, "Finding Site") = (T-32600, SRT, "Left Ventricle") (111031, DCM, "Image View") = (G-A19C, SRT, "Apical four chamber") (G-C036, SRT, "Measurement Method") = (125208, DCM, "Method of Disks, Single Plane")</b>
<b>CI(MOD A4C)/AutoHR</b> <b>Alias: CI MOD A4C</b>	<b>(F-32110, SRT, "Cardiac Index")</b>	<b>(G-C0E3, SRT, "Finding Site") = (T-32600, SRT, "Left Ventricle") (111031, DCM, "Image View") = (G-A19C, SRT, "Apical four chamber") (G-C036, SRT, "Measurement Method") = (125208, DCM, "Method of Disks, Single Plane")</b>
<b>CO(A-L A2C)/AutoHR</b> <b>Alias: CO A-L A2C</b>	<b>(F-32100, SRT, "Cardiac Output")</b>	<b>(G-C0E3, SRT, "Finding Site") = (T-32600, SRT, "Left Ventricle") (111031, DCM, "Image View") = (G-A19B, SRT, "Apical two chamber") (G-C036, SRT, "Measurement Method") = (125205, DCM, "Area-</b>

		Length Single Plane")
<p>CI(A-L A2C)/AutoHR Alias: CI A-L A2C</p>	<p>(F-32110, SRT, "Cardiac Index")</p>	<p>(G-C0E3, SRT, "Finding Site") = (T-32600, SRT, "Left Ventricle") (111031, DCM, "Image View") = (G-A19B, SRT, "Apical two chamber") (G-C036, SRT, "Measurement Method") = (125205, DCM, "Area-Length Single Plane")</p>
<p>CO(MOD A2C)/AutoHR Alias: CO MOD A2C</p>	<p>(F-32100, SRT, "Cardiac Output")</p>	<p>(G-C0E3, SRT, "Finding Site") = (T-32600, SRT, "Left Ventricle") (111031, DCM, "Image View") = (G-A19B, SRT, "Apical two chamber") (G-C036, SRT, "Measurement Method") = (125208, DCM, "Method of Disks, Single Plane")</p>
<p>CI(MOD A2C)/AutoHR Alias: CI MOD A2C</p>	<p>(F-32110, SRT, "Cardiac Index")</p>	<p>(G-C0E3, SRT, "Finding Site") = (T-32600, SRT, "Left Ventricle") (111031, DCM, "Image View") = (G-A19B, SRT, "Apical two chamber") (G-C036, SRT, "Measurement Method") = (125208, DCM, "Method of Disks, Single Plane")</p>
<p>CO(A-L LAX)/AutoHR Alias: CO A-L LAX</p>	<p>(F-32100, SRT, "Cardiac Output")</p>	<p>(G-C0E3, SRT, "Finding Site") = (T-32600, SRT, "Left Ventricle") (111031, DCM, "Image View") = (G-0395, SRT, "Apical long axis") (G-C036, SRT, "Measurement Method") = (125205, DCM, "Area-Length Single Plane")</p>
<p>CI(A-L LAX)/AutoHR Alias: CI A-L LAX</p>	<p>(F-32110, SRT, "Cardiac Index")</p>	<p>(G-C0E3, SRT, "Finding Site") = (T-32600, SRT, "Left Ventricle") (111031, DCM, "Image View") = (G-0395, SRT, "Apical long axis") (G-C036, SRT, "Measurement Method") = (125205, DCM, "Area-Length Single Plane")</p>
<p>CO(MOD LAX)/AutoHR Alias: CO MOD LAX</p>	<p>(F-32100, SRT, "Cardiac Output")</p>	<p>(G-C0E3, SRT, "Finding Site") = (T-32600, SRT, "Left Ventricle") (111031, DCM, "Image View") = (G-0395, SRT, "Apical long axis") (G-C036, SRT, "Measurement Method") = (125208, DCM,</p>

		"Method of Disks, Single Plane")
<b>CI(MOD LAX)/AutoHR</b> Alias: CI MOD LAX	(F-32110, SRT, "Cardiac Index")	(G-C0E3, SRT, "Finding Site") = (T-32600, SRT, "Left Ventricle") (111031, DCM, "Image View") = (G-0395, SRT, "Apical long axis") (G-C036, SRT, "Measurement Method") = (125208, DCM, "Method of Disks, Single Plane")
<b>LVEDV(MOD BP)_03</b> Alias: LVEDV MOD BP	(18026-5, LN, "Left Ventricular End Diastolic Volume")	(G-C036, SRT, "Measurement Method") = (125207, DCM, "Method of Disks, Biplane")
<b>LVESV(MOD BP)_03</b> Alias: LVESV MOD BP	(18148-7, LN, "Left Ventricular End Systolic Volume")	(G-C036, SRT, "Measurement Method") = (125207, DCM, "Method of Disks, Biplane")
<b>EF(Biplane)_03</b> Alias: EF Biplane	(18043-0, LN, "Left Ventricular Ejection Fraction")	(G-C036, SRT, "Measurement Method") = (125207, DCM, "Method of Disks, Biplane")
<b>SV(Biplane)_03</b> Alias: SV Biplane	(F-32120, SRT, "Stroke Volume")	(G-C036, SRT, "Measurement Method") = (125207, DCM, "Method of Disks, Biplane")
<b>SI(Biplane)_03</b> Alias: SI Biplane	(F-00078, SRT, "Stroke Index")	(G-C036, SRT, "Measurement Method") = (125207, DCM, "Method of Disks, Biplane")
<b>CO(Biplane)_03</b> Alias: CO Biplane	(F-32100, SRT, "Cardiac Output")	(G-C036, SRT, "Measurement Method") = (125207, DCM, "Method of Disks, Biplane")
<b>CI(Biplane)_03</b> Alias: CI Biplane	(F-32110, SRT, "Cardiac Index")	(G-C036, SRT, "Measurement Method") = (125207, DCM, "Method of Disks, Biplane")
<b>ECG/HeartRate/Auto</b> Alias: HR	(8867-4, LN, "Heart rate")	
<b>2D/LV Major</b> Alias: LV Major	(G-A193, SRT, "Major Axis")	(G-0373, SRT, "Image Mode") = (G-03A2, SRT, "2D mode") or (R-409E2, SRT, "Doppler Color Flow") depending on scan mode
<b>2D/LV Minor</b>	(G-A194, SRT, "Minor	(G-0373, SRT, "Image Mode") = (G-03A2, SRT, "2D mode") or (R-

Alias: LV Minor	Axis")	409E2, SRT, "Doppler Color Flow") depending on scan mode
2D/IVSd Alias: IVSd	(18154-5, LN, "Interventricular Septum Diastolic Thickness")	(G-0373, SRT, "Image Mode") = (G-03A2, SRT, "2D mode") or (R-409E2, SRT, "Doppler Color Flow") depending on scan mode
2D/LVIDd Alias: LVIDd	(29436-3, LN, "Left Ventricle Internal End Diastolic Dimension")	(G-0373, SRT, "Image Mode") = (G-03A2, SRT, "2D mode") or (R-409E2, SRT, "Doppler Color Flow") depending on scan mode
2D/LVIDs Alias: LVIDs	(29438-9, LN, "Left Ventricle Internal Systolic Dimension")	(G-0373, SRT, "Image Mode") = (G-03A2, SRT, "2D mode") or (R-409E2, SRT, "Doppler Color Flow") depending on scan mode
2D/LVIDs Index Alias: LVIDs Index	(GEU-106-0029, 99GEMS, "Left Ventricle Internal Systolic Dimension Index")	(G-0373, SRT, "Image Mode") = (G-03A2, SRT, "2D mode") or (R-409E2, SRT, "Doppler Color Flow") depending on scan mode
2D/LVPWd Alias: LVPWd	(18152-9, LN, "Left Ventricle Posterior Wall Diastolic Thickness")	(G-0373, SRT, "Image Mode") = (G-03A2, SRT, "2D mode") or (R-409E2, SRT, "Doppler Color Flow") depending on scan mode
2D/LVPWs Alias: LVPWs	(18156-0, LN, "Left Ventricle Posterior Wall Systolic Thickness")	(G-0373, SRT, "Image Mode") = (G-03A2, SRT, "2D mode") or (R-409E2, SRT, "Doppler Color Flow") depending on scan mode
2D/IVSs Alias: IVSs	(18158-6, LN, "Interventricular Septum Systolic Thickness")	(G-0373, SRT, "Image Mode") = (G-03A2, SRT, "2D mode") or (R-409E2, SRT, "Doppler Color Flow") depending on scan mode
2D/LVOT Diam Alias: LVOT Diam	(G-038F, SRT, "Cardiovascular Orifice Diameter")	(G-C0E3, SRT, "Finding Site") = (T-32650, SRT, "Left Ventricle Outflow Tract") (G-0373, SRT, "Image Mode") = (G-03A2, SRT, "2D mode") or (R-409E2, SRT, "Doppler Color Flow") depending on scan mode
2D/EDV(Teich) Alias: EDV(Teich)	(18026-5, LN, "Left Ventricular End Diastolic Volume")	(G-0373, SRT, "Image Mode") = (G-03A2, SRT, "2D mode") or (R-409E2, SRT, "Doppler Color Flow") depending on scan mode

		(G-C036, SRT, "Measurement Method") = (125209, DCM, "Teichholz")
2D/ESV(Teich) Alias: ESV(Teich)	(18148-7, LN, "Left Ventricular End Systolic Volume")	(G-0373, SRT, "Image Mode") = (G-03A2, SRT, "2D mode") or (R-409E2, SRT, "Doppler Color Flow") depending on scan mode (G-C036, SRT, "Measurement Method") = (125209, DCM, "Teichholz")
2D/EF(Teich) Alias: EF(Teich)	(18043-0, LN, "Left Ventricular Ejection Fraction")	(G-0373, SRT, "Image Mode") = (G-03A2, SRT, "2D mode") or (R-409E2, SRT, "Doppler Color Flow") depending on scan mode (G-C036, SRT, "Measurement Method") = (125209, DCM, "Teichholz")
2D/EDV(Cube) Alias: EDV(Cube)	(18026-5, LN, "Left Ventricular End Diastolic Volume")	(G-0373, SRT, "Image Mode") = (G-03A2, SRT, "2D mode") or (R-409E2, SRT, "Doppler Color Flow") depending on scan mode (G-C036, SRT, "Measurement Method") = (125206, DCM, "Cube Method")
2D/ESV(Cube) Alias: ESV(Cube)	(18148-7, LN, "Left Ventricular End Systolic Volume")	(G-0373, SRT, "Image Mode") = (G-03A2, SRT, "2D mode") or (R-409E2, SRT, "Doppler Color Flow") depending on scan mode (G-C036, SRT, "Measurement Method") = (125206, DCM, "Cube Method")
2D/EF(Cube) Alias: EF(Cube)	(18043-0, LN, "Left Ventricular Ejection Fraction")	(G-0373, SRT, "Image Mode") = (G-03A2, SRT, "2D mode") or (R-409E2, SRT, "Doppler Color Flow") depending on scan mode (G-C036, SRT, "Measurement Method") = (125206, DCM, "Cube Method")
2D/%FS Alias: %FS	(18051-3, LN, "Left Ventricular Fractional Shortening")	(G-0373, SRT, "Image Mode") = (G-03A2, SRT, "2D mode") or (R-409E2, SRT, "Doppler Color Flow") depending on scan mode
2D/%IVS Thck	(18054-7, LN, "Interventricular Septum %	(G-0373, SRT, "Image Mode") = (G-03A2, SRT, "2D mode") or (R-



Alias: %IVS Thck	Thickening")	409E2, SRT, "Doppler Color Flow") depending on scan mode
2D/%LVPW Thck Alias: %LVPW Thck	(18053-9, LN, "Left Ventricle Posterior Wall % Thickening")	(G-0373, SRT, "Image Mode") = (G-03A2, SRT, "2D mode") or (R-409E2, SRT, "Doppler Color Flow") depending on scan mode
2D/SV(Teich) Alias: SV(Teich)	(F-32120, SRT, "Stroke Volume")	(G-C0E3, SRT, "Finding Site") = (T-32600, SRT, "Left Ventricle") (G-0373, SRT, "Image Mode") = (G-03A2, SRT, "2D mode") or (R-409E2, SRT, "Doppler Color Flow") depending on scan mode (G-C036, SRT, "Measurement Method") = (125209, DCM, "Teichholz")
2D/SI(Teich) Alias: SI(Teich)	(F-00078, SRT, "Stroke Index")	(G-C0E3, SRT, "Finding Site") = (T-32600, SRT, "Left Ventricle") (G-0373, SRT, "Image Mode") = (G-03A2, SRT, "2D mode") or (R-409E2, SRT, "Doppler Color Flow") depending on scan mode (G-C036, SRT, "Measurement Method") = (125209, DCM, "Teichholz")
2D/CO(Teich) Alias: CO(Teich)	(F-32100, SRT, "Cardiac Output")	(G-C0E3, SRT, "Finding Site") = (T-32600, SRT, "Left Ventricle") (G-0373, SRT, "Image Mode") = (G-03A2, SRT, "2D mode") or (R-409E2, SRT, "Doppler Color Flow") depending on scan mode (G-C036, SRT, "Measurement Method") = (125209, DCM, "Teichholz")
2D/CI(Teich) Alias: CI(Teich)	(F-32110, SRT, "Cardiac Index")	(G-C0E3, SRT, "Finding Site") = (T-32600, SRT, "Left Ventricle") (G-0373, SRT, "Image Mode") = (G-03A2, SRT, "2D mode") or (R-409E2, SRT, "Doppler Color Flow") depending on scan mode (G-C036, SRT, "Measurement Method") = (125209, DCM, "Teichholz")
2D/SV(Cube)	(F-32120, SRT, "Stroke Volume")	(G-C0E3, SRT, "Finding Site") = (T-32600, SRT, "Left Ventricle") (G-0373, SRT, "Image Mode") =



Alias: SV(Cube)		(G-03A2, SRT, "2D mode") or (R-409E2, SRT, "Doppler Color Flow") depending on scan mode (G-C036, SRT, "Measurement Method") = (125206, DCM, "Cube Method")
2D/SI(Cube) Alias: SI(Cube)	(F-00078, SRT, "Stroke Index")	(G-C0E3, SRT, "Finding Site") = (T-32600, SRT, "Left Ventricle") (G-0373, SRT, "Image Mode") = (G-03A2, SRT, "2D mode") or (R-409E2, SRT, "Doppler Color Flow") depending on scan mode (G-C036, SRT, "Measurement Method") = (125206, DCM, "Cube Method")
2D/CO(Cube) Alias: CO(Cube)	(F-32100, SRT, "Cardiac Output")	(G-C0E3, SRT, "Finding Site") = (T-32600, SRT, "Left Ventricle") (G-0373, SRT, "Image Mode") = (G-03A2, SRT, "2D mode") or (R-409E2, SRT, "Doppler Color Flow") depending on scan mode (G-C036, SRT, "Measurement Method") = (125206, DCM, "Cube Method")
2D/CI(Cube) Alias: CI(Cube)	(F-32110, SRT, "Cardiac Index")	(G-C0E3, SRT, "Finding Site") = (T-32600, SRT, "Left Ventricle") (G-0373, SRT, "Image Mode") = (G-03A2, SRT, "2D mode") or (R-409E2, SRT, "Doppler Color Flow") depending on scan mode (G-C036, SRT, "Measurement Method") = (125206, DCM, "Cube Method")
2D/LVd Mass Alias: LVd Mass	(18087-7, LN, "Left Ventricle Mass")	(G-0373, SRT, "Image Mode") = (G-03A2, SRT, "2D mode") or (R-409E2, SRT, "Doppler Color Flow") depending on scan mode (R-4089A, SRT, "Cardiac Cycle Point") = (F-32010, SRT, "Diastole")
2D/LVs Mass Alias: LVs Mass	(18087-7, LN, "Left Ventricle Mass")	(G-0373, SRT, "Image Mode") = (G-03A2, SRT, "2D mode") or (R-409E2, SRT, "Doppler Color Flow") depending on scan mode (R-4089A, SRT, "Cardiac Cycle Point") = (F-32020, SRT, "Systole")

<p><b>2D/LVd Mass/ASE</b> Alias: LVd Mass (ASE)</p>	<p>(18087-7, LN, "Left Ventricle Mass")</p>	<p>(G-0373, SRT, "Image Mode") = (G-03A2, SRT, "2D mode") or (R-409E2, SRT, "Doppler Color Flow") depending on scan mode (R-4089A, SRT, "Cardiac Cycle Point") = (F-32010, SRT, "Diastole") (G-C036, SRT, "Measurement Method") = (125221, DCM, "Left Ventricle Mass by M-mode")</p>
<p><b>2D/LVs Mass/ASE</b> Alias: LVs Mass (ASE)</p>	<p>(18087-7, LN, "Left Ventricle Mass")</p>	<p>(G-0373, SRT, "Image Mode") = (G-03A2, SRT, "2D mode") or (R-409E2, SRT, "Doppler Color Flow") depending on scan mode (R-4089A, SRT, "Cardiac Cycle Point") = (F-32020, SRT, "Systole") (G-C036, SRT, "Measurement Method") = (125221, DCM, "Left Ventricle Mass by M-mode")</p>
<p><b>2D/LVA diastole</b> Alias: LVA (d)</p>	<p>(G-0375, SRT, "Left Ventricular Diastolic Area")</p>	<p>(G-0373, SRT, "Image Mode") = (G-03A2, SRT, "2D mode") or (R-409E2, SRT, "Doppler Color Flow") depending on scan mode</p>
<p><b>2D/LVA systole</b> Alias: LVA (s)</p>	<p>(G-0374, SRT, "Left Ventricular Systolic Area")</p>	<p>(G-0373, SRT, "Image Mode") = (G-03A2, SRT, "2D mode") or (R-409E2, SRT, "Doppler Color Flow") depending on scan mode</p>
<p><b>2D/SAX/LVA diastole</b> Alias: LVA (d)</p>	<p>(G-0375, SRT, "Left Ventricular Diastolic Area")</p>	<p>(G-0373, SRT, "Image Mode") = (G-03A2, SRT, "2D mode") or (R-409E2, SRT, "Doppler Color Flow") depending on scan mode (111031, DCM, "Image View") = (G-0397, SRT, "Parasternal short axis")</p>
<p><b>2D/SAX/LVA systole</b> Alias: LVA (s)</p>	<p>(G-0374, SRT, "Left Ventricular Systolic Area")</p>	<p>(G-0373, SRT, "Image Mode") = (G-03A2, SRT, "2D mode") or (R-409E2, SRT, "Doppler Color Flow") depending on scan mode (111031, DCM, "Image View") = (G-0397, SRT, "Parasternal short axis")</p>
<p><b>2D/SAX/LVAepi diastole</b> Alias: LVAepi (d)</p>	<p>(59093-5, LN, "Epicardial Area")</p>	<p>(G-0373, SRT, "Image Mode") = (G-03A2, SRT, "2D mode") or (R-409E2, SRT, "Doppler Color Flow") depending on scan mode</p>

		(111031, DCM, "Image View") = (G-0397, SRT, "Parasternal short axis") (R-4089A, SRT, "Cardiac Cycle Point") = (F-32010, SRT, "Diastole")
<b>2D/SAX/LVAepi systole</b> <b>Alias: LVAepi (s)</b>	(59093-5, LN, "Epicardial Area")	(G-0373, SRT, "Image Mode") = (G-03A2, SRT, "2D mode") or (R-409E2, SRT, "Doppler Color Flow") depending on scan mode (111031, DCM, "Image View") = (G-0397, SRT, "Parasternal short axis") (R-4089A, SRT, "Cardiac Cycle Point") = (F-32020, SRT, "Systole")
<b>2D/SAX/LVAend diastole</b> <b>Alias: LVAend (d)</b>	(59094-3, LN, "Endocardial Area")	(G-0373, SRT, "Image Mode") = (G-03A2, SRT, "2D mode") or (R-409E2, SRT, "Doppler Color Flow") depending on scan mode (111031, DCM, "Image View") = (G-0397, SRT, "Parasternal short axis") (R-4089A, SRT, "Cardiac Cycle Point") = (F-32010, SRT, "Diastole")
<b>2D/SAX/LVAend systole</b> <b>Alias: LVAend (s)</b>	(59094-3, LN, "Endocardial Area")	(G-0373, SRT, "Image Mode") = (G-03A2, SRT, "2D mode") or (R-409E2, SRT, "Doppler Color Flow") depending on scan mode (111031, DCM, "Image View") = (G-0397, SRT, "Parasternal short axis") (R-4089A, SRT, "Cardiac Cycle Point") = (F-32020, SRT, "Systole")
<b>2D/LVOT Area</b> <b>Alias: LVOT Area</b>	(G-038E, SRT, "Cardiovascular Orifice Area")	(G-C0E3, SRT, "Finding Site") = (T-32650, SRT, "Left Ventricle Outflow Tract") (G-0373, SRT, "Image Mode") = (G-03A2, SRT, "2D mode") or (R-409E2, SRT, "Doppler Color Flow") depending on scan mode
<b>2D/EDV(A-L)</b> <b>Alias: EDV(A-L)</b>	(18026-5, LN, "Left Ventricular End Diastolic Volume")	(G-0373, SRT, "Image Mode") = (G-03A2, SRT, "2D mode") or (R-409E2, SRT, "Doppler Color Flow") depending on scan mode (G-C036, SRT, "Measurement Method") = (125205, DCM, "Area-

		Length Single Plane")
2D/EDV(MOD) Alias: EDV(MOD)	(18026-5, LN, "Left Ventricular End Diastolic Volume")	(G-0373, SRT, "Image Mode") = (G-03A2, SRT, "2D mode") or (R-409E2, SRT, "Doppler Color Flow") depending on scan mode (G-C036, SRT, "Measurement Method") = (125208, DCM, "Method of Disks, Single Plane")
2D/ESV(A-L) Alias: ESV(A-L)	(18148-7, LN, "Left Ventricular End Systolic Volume")	(G-0373, SRT, "Image Mode") = (G-03A2, SRT, "2D mode") or (R-409E2, SRT, "Doppler Color Flow") depending on scan mode (G-C036, SRT, "Measurement Method") = (125205, DCM, "Area-Length Single Plane")
2D/ESV(MOD) Alias: ESV(MOD)	(18148-7, LN, "Left Ventricular End Systolic Volume")	(G-0373, SRT, "Image Mode") = (G-03A2, SRT, "2D mode") or (R-409E2, SRT, "Doppler Color Flow") depending on scan mode (G-C036, SRT, "Measurement Method") = (125208, DCM, "Method of Disks, Single Plane")
2D/EF(A-L) Alias: EF(A-L)	(18043-0, LN, "Left Ventricular Ejection Fraction")	(G-0373, SRT, "Image Mode") = (G-03A2, SRT, "2D mode") or (R-409E2, SRT, "Doppler Color Flow") depending on scan mode (G-C036, SRT, "Measurement Method") = (125205, DCM, "Area-Length Single Plane")
2D/SV(A-L) Alias: SV(A-L)	(F-32120, SRT, "Stroke Volume")	(G-C0E3, SRT, "Finding Site") = (T-32600, SRT, "Left Ventricle") (G-0373, SRT, "Image Mode") = (G-03A2, SRT, "2D mode") or (R-409E2, SRT, "Doppler Color Flow") depending on scan mode (G-C036, SRT, "Measurement Method") = (125205, DCM, "Area-Length Single Plane")
2D/SI(A-L) Alias: SI(A-L)	(F-00078, SRT, "Stroke Index")	(G-C0E3, SRT, "Finding Site") = (T-32600, SRT, "Left Ventricle") (G-0373, SRT, "Image Mode") = (G-03A2, SRT, "2D mode") or (R-409E2, SRT, "Doppler Color Flow") depending on scan mode (G-C036, SRT, "Measurement

		Method") = (125205, DCM, "Area- Length Single Plane")
<b>2D/EF(MOD)</b> Alias: EF(MOD)	(18043-0, LN, "Left Ventricular Ejection Fraction")	(G-0373, SRT, "Image Mode") = (G-03A2, SRT, "2D mode") or (R- 409E2, SRT, "Doppler Color Flow") depending on scan mode (G-C036, SRT, "Measurement Method") = (125208, DCM, "Method of Disks, Single Plane")
<b>2D/SV(MOD)</b> Alias: SV(MOD)	(F-32120, SRT, "Stroke Volume")	(G-C0E3, SRT, "Finding Site") = (T-32600, SRT, "Left Ventricle") (G-0373, SRT, "Image Mode") = (G-03A2, SRT, "2D mode") or (R- 409E2, SRT, "Doppler Color Flow") depending on scan mode (G-C036, SRT, "Measurement Method") = (125208, DCM, "Method of Disks, Single Plane")
<b>2D/SI(MOD)</b> Alias: SI(MOD)	(F-00078, SRT, "Stroke Index")	(G-C0E3, SRT, "Finding Site") = (T-32600, SRT, "Left Ventricle") (G-0373, SRT, "Image Mode") = (G-03A2, SRT, "2D mode") or (R- 409E2, SRT, "Doppler Color Flow") depending on scan mode (G-C036, SRT, "Measurement Method") = (125208, DCM, "Method of Disks, Single Plane")
<b>LVLd(A4C)</b> Alias: LVLd A4C	(18074-5, LN, "Left Ventricular Major Axis Diastolic Dimension, 4- chamber view")	
<b>LVAd(A4C)</b> Alias: LVAd A4C	(G-0375, SRT, "Left Ventricular Diastolic Area")	(111031, DCM, "Image View") = (G-A19C, SRT, "Apical four chamber")
<b>LVEDV(A-L A4C)</b> Alias: LVEDV A-L A4C	(18026-5, LN, "Left Ventricular End Diastolic Volume")	(111031, DCM, "Image View") = (G-A19C, SRT, "Apical four chamber") (G-C036, SRT, "Measurement Method") = (125205, DCM, "Area- Length Single Plane")
<b>LVEDV(MOD A4C)</b> Alias: LVEDV MOD A4C	(18026-5, LN, "Left Ventricular End Diastolic Volume")	(111031, DCM, "Image View") = (G-A19C, SRT, "Apical four chamber") (G-C036, SRT, "Measurement

		Method") = (125208, DCM, "Method of Disks, Single Plane")
LVLs(A4C) Alias: LVLs A4C	(18075-2, LN, "Left Ventricular Major Axis Systolic Dimension, 4-chamber view")	
LVAs(A4C) Alias: LVAs A4C	(G-0374, SRT, "Left Ventricular Systolic Area")	(111031, DCM, "Image View") = (G-A19C, SRT, "Apical four chamber")
LVESV(A-L A4C) Alias: LVESV A-L A4C	(18148-7, LN, "Left Ventricular End Systolic Volume")	(111031, DCM, "Image View") = (G-A19C, SRT, "Apical four chamber") (G-C036, SRT, "Measurement Method") = (125205, DCM, "Area-Length Single Plane")
LVESV(MOD A4C) Alias: LVESV MOD A4C	(18148-7, LN, "Left Ventricular End Systolic Volume")	(111031, DCM, "Image View") = (G-A19C, SRT, "Apical four chamber") (G-C036, SRT, "Measurement Method") = (125208, DCM, "Method of Disks, Single Plane")
EF(A-L A4C) Alias: EF A-L A4C	(18043-0, LN, "Left Ventricular Ejection Fraction")	(111031, DCM, "Image View") = (G-A19C, SRT, "Apical four chamber") (G-C036, SRT, "Measurement Method") = (125205, DCM, "Area-Length Single Plane")
SV(A-L A4C) Alias: SV A-L A4C	(F-32120, SRT, "Stroke Volume")	(G-C0E3, SRT, "Finding Site") = (T-32600, SRT, "Left Ventricle") (111031, DCM, "Image View") = (G-A19C, SRT, "Apical four chamber") (G-C036, SRT, "Measurement Method") = (125205, DCM, "Area-Length Single Plane")
SI(A-L A4C) Alias: SI A-L A4C	(F-00078, SRT, "Stroke Index")	(G-C0E3, SRT, "Finding Site") = (T-32600, SRT, "Left Ventricle") (111031, DCM, "Image View") = (G-A19C, SRT, "Apical four chamber") (G-C036, SRT, "Measurement Method") = (125205, DCM, "Area-Length Single Plane")

<p><b>CO(A-L A4C)</b>  <b>Alias: CO A-L A4C</b></p>	<p><b>(F-32100, SRT, "Cardiac Output")</b></p>	<p><b>(G-C0E3, SRT, "Finding Site") = (T-32600, SRT, "Left Ventricle") (111031, DCM, "Image View") = (G-A19C, SRT, "Apical four chamber") (G-C036, SRT, "Measurement Method") = (125205, DCM, "Area-Length Single Plane")</b></p>
<p><b>CI(A-L A4C)</b>  <b>Alias: CI A-L A4C</b></p>	<p><b>(F-32110, SRT, "Cardiac Index")</b></p>	<p><b>(G-C0E3, SRT, "Finding Site") = (T-32600, SRT, "Left Ventricle") (111031, DCM, "Image View") = (G-A19C, SRT, "Apical four chamber") (G-C036, SRT, "Measurement Method") = (125205, DCM, "Area-Length Single Plane")</b></p>
<p><b>EF(MOD A4C)</b>  <b>Alias: LVEF MOD A4C</b></p>	<p><b>(18043-0, LN, "Left Ventricular Ejection Fraction")</b></p>	<p><b>(111031, DCM, "Image View") = (G-A19C, SRT, "Apical four chamber") (G-C036, SRT, "Measurement Method") = (125208, DCM, "Method of Disks, Single Plane")</b></p>
<p><b>SV(MOD A4C)</b>  <b>Alias: SV MOD A4C</b></p>	<p><b>(F-32120, SRT, "Stroke Volume")</b></p>	<p><b>(G-C0E3, SRT, "Finding Site") = (T-32600, SRT, "Left Ventricle") (111031, DCM, "Image View") = (G-A19C, SRT, "Apical four chamber") (G-C036, SRT, "Measurement Method") = (125208, DCM, "Method of Disks, Single Plane")</b></p>
<p><b>SI(MOD A4C)</b>  <b>Alias: SI MOD A4C</b></p>	<p><b>(F-00078, SRT, "Stroke Index")</b></p>	<p><b>(G-C0E3, SRT, "Finding Site") = (T-32600, SRT, "Left Ventricle") (111031, DCM, "Image View") = (G-A19C, SRT, "Apical four chamber") (G-C036, SRT, "Measurement Method") = (125208, DCM, "Method of Disks, Single Plane")</b></p>
<p><b>CO(MOD A4C)</b>  <b>Alias: CO MOD A4C</b></p>	<p><b>(F-32100, SRT, "Cardiac Output")</b></p>	<p><b>(G-C0E3, SRT, "Finding Site") = (T-32600, SRT, "Left Ventricle") (111031, DCM, "Image View") = (G-A19C, SRT, "Apical four chamber") (G-C036, SRT, "Measurement Method") = (125208, DCM, "Method of Disks, Single Plane")</b></p>

<p><b>CI(MOD A4C)</b> Alias: CI MOD A4C</p>	<p>(F-32110, SRT, "Cardiac Index")</p>	<p>(G-C0E3, SRT, "Finding Site") = (T-32600, SRT, "Left Ventricle") (111031, DCM, "Image View") = (G-A19C, SRT, "Apical four chamber") (G-C036, SRT, "Measurement Method") = (125208, DCM, "Method of Disks, Single Plane")</p>
<p><b>LVLd(A2C)</b> Alias: LVLd A2C</p>	<p>(18072-9, LN, "Left Ventricular Major Axis Diastolic Dimension, 2-chamber view")</p>	
<p><b>LVAd(A2C)</b> Alias: LVAd A2C</p>	<p>(G-0375, SRT, "Left Ventricular Diastolic Area")</p>	<p>(111031, DCM, "Image View") = (G-A19B, SRT, "Apical two chamber")</p>
<p><b>LVEDV(A-L A2C)</b> Alias: LVEDV A-L A2C</p>	<p>(18026-5, LN, "Left Ventricular End Diastolic Volume")</p>	<p>(111031, DCM, "Image View") = (G-A19B, SRT, "Apical two chamber") (G-C036, SRT, "Measurement Method") = (125205, DCM, "Area-Length Single Plane")</p>
<p><b>LVEDV(MOD A2C)</b> Alias: LVEDV MOD A2C</p>	<p>(18026-5, LN, "Left Ventricular End Diastolic Volume")</p>	<p>(111031, DCM, "Image View") = (G-A19B, SRT, "Apical two chamber") (G-C036, SRT, "Measurement Method") = (125208, DCM, "Method of Disks, Single Plane")</p>
<p><b>LVLs(A2C)</b> Alias: LVLs A2C</p>	<p>(18073-7, LN, "Left Ventricular Major Axis Systolic Dimension, 2-chamber view")</p>	
<p><b>LVAs(A2C)</b> Alias: LVAs A2C</p>	<p>(G-0374, SRT, "Left Ventricular Systolic Area")</p>	<p>(111031, DCM, "Image View") = (G-A19B, SRT, "Apical two chamber")</p>
<p><b>LVESV(A-L A2C)</b> Alias: LVESV A-L A2C</p>	<p>(18148-7, LN, "Left Ventricular End Systolic Volume")</p>	<p>(111031, DCM, "Image View") = (G-A19B, SRT, "Apical two chamber") (G-C036, SRT, "Measurement Method") = (125205, DCM, "Area-Length Single Plane")</p>
<p><b>LVESV(MOD A2C)</b></p>	<p>(18148-7, LN, "Left Ventricular End Systolic</p>	<p>(111031, DCM, "Image View") = (G-A19B, SRT, "Apical two</p>



Alias: LVESV MOD A2C	Volume"))	chamber")) (G-C036, SRT, "Measurement Method") = (125208, DCM, "Method of Disks, Single Plane")
EF(A-L A2C) Alias: EF A-L A2C	(18043-0, LN, "Left Ventricular Ejection Fraction"))	(111031, DCM, "Image View") = (G-A19B, SRT, "Apical two chamber") (G-C036, SRT, "Measurement Method") = (125205, DCM, "Area-Length Single Plane")
SV(A-L A2C) Alias: SV A-L A2C	(F-32120, SRT, "Stroke Volume"))	(G-C0E3, SRT, "Finding Site") = (T-32600, SRT, "Left Ventricle") (111031, DCM, "Image View") = (G-A19B, SRT, "Apical two chamber") (G-C036, SRT, "Measurement Method") = (125205, DCM, "Area-Length Single Plane")
SI(A-L A2C) Alias: SI A-L A2C	(F-00078, SRT, "Stroke Index"))	(G-C0E3, SRT, "Finding Site") = (T-32600, SRT, "Left Ventricle") (111031, DCM, "Image View") = (G-A19B, SRT, "Apical two chamber") (G-C036, SRT, "Measurement Method") = (125205, DCM, "Area-Length Single Plane")
CO(A-L A2C) Alias: CO A-L A2C	(F-32100, SRT, "Cardiac Output"))	(G-C0E3, SRT, "Finding Site") = (T-32600, SRT, "Left Ventricle") (111031, DCM, "Image View") = (G-A19B, SRT, "Apical two chamber") (G-C036, SRT, "Measurement Method") = (125205, DCM, "Area-Length Single Plane")
CI(A-L A2C) Alias: CI A-L A2C	(F-32110, SRT, "Cardiac Index"))	(G-C0E3, SRT, "Finding Site") = (T-32600, SRT, "Left Ventricle") (111031, DCM, "Image View") = (G-A19B, SRT, "Apical two chamber") (G-C036, SRT, "Measurement Method") = (125205, DCM, "Area-Length Single Plane")
EF(MOD A2C)	(18043-0, LN, "Left Ventricular Ejection	(111031, DCM, "Image View") = (G-A19B, SRT, "Apical two chamber")

Alias: LVEF MOD A2C	Fraction")	(G-C036, SRT, "Measurement Method") = (125208, DCM, "Method of Disks, Single Plane")
SV(MOD A2C) Alias: SV MOD A2C	(F-32120, SRT, "Stroke Volume")	(G-C0E3, SRT, "Finding Site") = (T-32600, SRT, "Left Ventricle") (111031, DCM, "Image View") = (G-A19B, SRT, "Apical two chamber") (G-C036, SRT, "Measurement Method") = (125208, DCM, "Method of Disks, Single Plane")
SI(MOD A2C) Alias: SI MOD A2C	(F-00078, SRT, "Stroke Index")	(G-C0E3, SRT, "Finding Site") = (T-32600, SRT, "Left Ventricle") (111031, DCM, "Image View") = (G-A19B, SRT, "Apical two chamber") (G-C036, SRT, "Measurement Method") = (125208, DCM, "Method of Disks, Single Plane")
CO(MOD A2C) Alias: CO MOD A2C	(F-32100, SRT, "Cardiac Output")	(G-C0E3, SRT, "Finding Site") = (T-32600, SRT, "Left Ventricle") (111031, DCM, "Image View") = (G-A19B, SRT, "Apical two chamber") (G-C036, SRT, "Measurement Method") = (125208, DCM, "Method of Disks, Single Plane")
CI(MOD A2C) Alias: CI MOD A2C	(F-32110, SRT, "Cardiac Index")	(G-C0E3, SRT, "Finding Site") = (T-32600, SRT, "Left Ventricle") (111031, DCM, "Image View") = (G-A19B, SRT, "Apical two chamber") (G-C036, SRT, "Measurement Method") = (125208, DCM, "Method of Disks, Single Plane")
LVAd(LAX) Alias: LVAd LAX	(G-0375, SRT, "Left Ventricular Diastolic Area")	(111031, DCM, "Image View") = (G-0395, SRT, "Apical long axis")
LVEDV(A-L LAX) Alias: LVEDV A-L LAX	(18026-5, LN, "Left Ventricular End Diastolic Volume")	(111031, DCM, "Image View") = (G-0395, SRT, "Apical long axis") (G-C036, SRT, "Measurement Method") = (125205, DCM, "Area-Length Single Plane")
LVEDV(MOD LAX)	(18026-5, LN, "Left	(111031, DCM, "Image View") =

Alias: LVEDV MOD LAX	Ventricular End Diastolic Volume")	(G-0395, SRT, "Apical long axis") (G-C036, SRT, "Measurement Method") = (125208, DCM, "Method of Disks, Single Plane")
LVAs(LAX) Alias: LVAs LAX	(G-0374, SRT, "Left Ventricular Systolic Area")	(111031, DCM, "Image View") = (G-0395, SRT, "Apical long axis")
LVESV(A-L LAX) Alias: LVESV A-L LAX	(18148-7, LN, "Left Ventricular End Systolic Volume")	(111031, DCM, "Image View") = (G-0395, SRT, "Apical long axis") (G-C036, SRT, "Measurement Method") = (125205, DCM, "Area-Length Single Plane")
LVESV(MOD LAX) Alias: LVESV MOD LAX	(18148-7, LN, "Left Ventricular End Systolic Volume")	(111031, DCM, "Image View") = (G-0395, SRT, "Apical long axis") (G-C036, SRT, "Measurement Method") = (125208, DCM, "Method of Disks, Single Plane")
EF(A-L LAX) Alias: EF A-L LAX	(18043-0, LN, "Left Ventricular Ejection Fraction")	(111031, DCM, "Image View") = (G-0395, SRT, "Apical long axis") (G-C036, SRT, "Measurement Method") = (125205, DCM, "Area-Length Single Plane")
SV(A-L LAX) Alias: SV A-L LAX	(F-32120, SRT, "Stroke Volume")	(G-C0E3, SRT, "Finding Site") = (T-32600, SRT, "Left Ventricle") (111031, DCM, "Image View") = (G-0395, SRT, "Apical long axis") (G-C036, SRT, "Measurement Method") = (125205, DCM, "Area-Length Single Plane")
SI(A-L LAX) Alias: SI A-L LAX	(F-00078, SRT, "Stroke Index")	(G-C0E3, SRT, "Finding Site") = (T-32600, SRT, "Left Ventricle") (111031, DCM, "Image View") = (G-0395, SRT, "Apical long axis") (G-C036, SRT, "Measurement Method") = (125205, DCM, "Area-Length Single Plane")
CO(A-L LAX) Alias: CO A-L LAX	(F-32100, SRT, "Cardiac Output")	(G-C0E3, SRT, "Finding Site") = (T-32600, SRT, "Left Ventricle") (111031, DCM, "Image View") = (G-0395, SRT, "Apical long axis") (G-C036, SRT, "Measurement Method") = (125205, DCM, "Area-Length Single Plane")

<p><b>CI(A-L LAX)</b>  <b>Alias: CI A-L LAX</b></p>	<p><b>(F-32110, SRT, "Cardiac Index")</b></p>	<p><b>(G-C0E3, SRT, "Finding Site") = (T-32600, SRT, "Left Ventricle") (111031, DCM, "Image View") = (G-0395, SRT, "Apical long axis") (G-C036, SRT, "Measurement Method") = (125205, DCM, "Area-Length Single Plane")</b></p>
<p><b>EF(MOD LAX)</b>  <b>Alias: LVEF MOD LAX</b></p>	<p><b>(18043-0, LN, "Left Ventricular Ejection Fraction")</b></p>	<p><b>(111031, DCM, "Image View") = (G-0395, SRT, "Apical long axis") (G-C036, SRT, "Measurement Method") = (125208, DCM, "Method of Disks, Single Plane")</b></p>
<p><b>SV(MOD LAX)</b>  <b>Alias: SV MOD LAX</b></p>	<p><b>(F-32120, SRT, "Stroke Volume")</b></p>	<p><b>(G-C0E3, SRT, "Finding Site") = (T-32600, SRT, "Left Ventricle") (111031, DCM, "Image View") = (G-0395, SRT, "Apical long axis") (G-C036, SRT, "Measurement Method") = (125208, DCM, "Method of Disks, Single Plane")</b></p>
<p><b>SI(MOD LAX)</b>  <b>Alias: SI MOD LAX</b></p>	<p><b>(F-00078, SRT, "Stroke Index")</b></p>	<p><b>(G-C0E3, SRT, "Finding Site") = (T-32600, SRT, "Left Ventricle") (111031, DCM, "Image View") = (G-0395, SRT, "Apical long axis") (G-C036, SRT, "Measurement Method") = (125208, DCM, "Method of Disks, Single Plane")</b></p>
<p><b>CO(MOD LAX)</b>  <b>Alias: CO MOD LAX</b></p>	<p><b>(F-32100, SRT, "Cardiac Output")</b></p>	<p><b>(G-C0E3, SRT, "Finding Site") = (T-32600, SRT, "Left Ventricle") (111031, DCM, "Image View") = (G-0395, SRT, "Apical long axis") (G-C036, SRT, "Measurement Method") = (125208, DCM, "Method of Disks, Single Plane")</b></p>
<p><b>CI(MOD LAX)</b>  <b>Alias: CI MOD LAX</b></p>	<p><b>(F-32110, SRT, "Cardiac Index")</b></p>	<p><b>(G-C0E3, SRT, "Finding Site") = (T-32600, SRT, "Left Ventricle") (111031, DCM, "Image View") = (G-0395, SRT, "Apical long axis") (G-C036, SRT, "Measurement Method") = (125208, DCM, "Method of Disks, Single Plane")</b></p>
<p><b>LVEDV(MOD BP)</b>  <b>Alias: LVEDV MOD BP</b></p>	<p><b>(18026-5, LN, "Left Ventricular End Diastolic Volume")</b></p>	<p><b>(G-C036, SRT, "Measurement Method") = (125207, DCM, "Method of Disks, Biplane")</b></p>

<b>LVESV(MOD BP)</b> Alias: LVESV MOD BP	(18148-7, LN, "Left Ventricular End Systolic Volume")	(G-C036, SRT, "Measurement Method") = (125207, DCM, "Method of Disks, Biplane")
<b>EF(Biplane)</b> Alias: EF Biplane	(18043-0, LN, "Left Ventricular Ejection Fraction")	(G-C036, SRT, "Measurement Method") = (125207, DCM, "Method of Disks, Biplane")
<b>SV(Biplane)</b> Alias: SV Biplane	(F-32120, SRT, "Stroke Volume")	(G-C036, SRT, "Measurement Method") = (125207, DCM, "Method of Disks, Biplane")
<b>SI(Biplane)</b> Alias: SI Biplane	(F-00078, SRT, "Stroke Index")	(G-C036, SRT, "Measurement Method") = (125207, DCM, "Method of Disks, Biplane")
<b>CO(Biplane)</b> Alias: CO Biplane	(F-32100, SRT, "Cardiac Output")	(G-C036, SRT, "Measurement Method") = (125207, DCM, "Method of Disks, Biplane")
<b>CI(Biplane)</b> Alias: CI Biplane	(F-32110, SRT, "Cardiac Index")	(G-C036, SRT, "Measurement Method") = (125207, DCM, "Method of Disks, Biplane")
<b>LVLd(apical)</b> Alias: LVLd apical	(18077-8, LN, "Left Ventricle diastolic major axis")	
<b>LVLs(apical)</b> Alias: LVLs apical	(18076-0, LN, "Left Ventricle systolic major axis")	
<b>LVAd(sax MV)</b> Alias: LVAd sax MV	(G-0375, SRT, "Left Ventricular Diastolic Area")	(111031, DCM, "Image View") = (G-039A, SRT, "Parasternal short axis at the Mitral Valve level")
<b>LVA(sax MV)</b> Alias: LVA(sax MV)	(G-0374, SRT, "Left Ventricular Systolic Area")	(111031, DCM, "Image View") = (G-039A, SRT, "Parasternal short axis at the Mitral Valve level")
<b>LVAd(sax PM)</b> Alias: LVAd sax PM	(G-0375, SRT, "Left Ventricular Diastolic Area")	(111031, DCM, "Image View") = (G-039B, SRT, "Parasternal short axis at the Papillary Muscle level")
<b>LVA(sax PM)</b> Alias: LVA(sax PM)	(G-0374, SRT, "Left Ventricular Systolic Area")	(111031, DCM, "Image View") = (G-039B, SRT, "Parasternal short axis at the Papillary Muscle level")

<p><b>LVAd(sax epi)</b>  <b>Alias: LVAd sax EPI</b></p>	<p>(G-0379, SRT, "Left Ventricle Epicardial Diastolic Area, psax pap view")</p>	<p>(G-0373, SRT, "Image Mode") = (G-03A2, SRT, "2D mode") or (R-409E2, SRT, "Doppler Color Flow") depending on scan mode</p>
<p><b>LVA(sax epi)</b>  <b>Alias: LVA(sax EPI)</b></p>	<p>(59093-5, LN, "Epicardial Area")</p>	<p>(G-0373, SRT, "Image Mode") = (G-03A2, SRT, "2D mode") or (R-409E2, SRT, "Doppler Color Flow") depending on scan mode  (111031, DCM, "Image View") = (G-039B, SRT, "Parasternal short axis at the Papillary Muscle level")  (R-4089A, SRT, "Cardiac Cycle Point") = (F-32020, SRT, "Systole")</p>
<p><b>LVAd(sax)</b>  <b>Alias: LVAd sax</b></p>	<p>(G-0375, SRT, "Left Ventricular Diastolic Area")</p>	<p>(111031, DCM, "Image View") = (G-0397, SRT, "Parasternal short axis")</p>
<p><b>LVA(sax)</b>  <b>Alias: LVA(sax)</b></p>	<p>(G-0374, SRT, "Left Ventricular Systolic Area")</p>	<p>(111031, DCM, "Image View") = (G-0397, SRT, "Parasternal short axis")</p>
<p><b>EDV(mod sim)</b>  <b>Alias: EDV mod sim</b></p>	<p>(18026-5, LN, "Left Ventricular End Diastolic Volume")</p>	
<p><b>ESV(mod sim)</b>  <b>Alias: ESV mod sim</b></p>	<p>(18148-7, LN, "Left Ventricular End Systolic Volume")</p>	
<p><b>EF(mod sim)</b>  <b>Alias: EF mod sim</b></p>	<p>(18043-0, LN, "Left Ventricular Ejection Fraction")</p>	
<p><b>SV(mod sim)</b>  <b>Alias: SV mod sim</b></p>	<p>(F-32120, SRT, "Stroke Volume")</p>	<p>(G-C0E3, SRT, "Finding Site") = (T-32600, SRT, "Left Ventricle")</p>
<p><b>SI(mod sim)</b>  <b>Alias: SI mod sim</b></p>	<p>(F-00078, SRT, "Stroke Index")</p>	<p>(G-C0E3, SRT, "Finding Site") = (T-32600, SRT, "Left Ventricle")</p>
<p><b>CO(mod sim)</b>  <b>Alias: CO mod sim</b></p>	<p>(F-32100, SRT, "Cardiac Output")</p>	<p>(G-C0E3, SRT, "Finding Site") = (T-32600, SRT, "Left Ventricle")</p>
<p><b>CI(mod sim)</b></p>	<p>(F-32110, SRT, "Cardiac</p>	<p>(G-C0E3, SRT, "Finding Site") =</p>

Alias: CI mod sim	Index")	(T-32600, SRT, "Left Ventricle")
EDV(bullet) Alias: EDV bullet	(18026-5, LN, "Left Ventricular End Diastolic Volume")	
ESV(bullet) Alias: ESV bullet	(18148-7, LN, "Left Ventricular End Systolic Volume")	
EF(bullet) Alias: LVEF Bullet	(18043-0, LN, "Left Ventricular Ejection Fraction")	
SV(bullet) Alias: SV bullet	(F-32120, SRT, "Stroke Volume")	(G-C0E3, SRT, "Finding Site") = (T-32600, SRT, "Left Ventricle")
SI(bullet) Alias: SI bullet	(F-00078, SRT, "Stroke Index")	(G-C0E3, SRT, "Finding Site") = (T-32600, SRT, "Left Ventricle")
CO(bullet) Alias: CO bullet	(F-32100, SRT, "Cardiac Output")	(G-C0E3, SRT, "Finding Site") = (T-32600, SRT, "Left Ventricle")
CI(bullet) Alias: CI bullet	(F-32110, SRT, "Cardiac Index")	(G-C0E3, SRT, "Finding Site") = (T-32600, SRT, "Left Ventricle")
EDV(bp el) Alias: EDV bp el	(18026-5, LN, "Left Ventricular End Diastolic Volume")	(G-C036, SRT, "Measurement Method") = (125211, DCM, "Biplane Ellipse")
ESV(bp el) Alias: ESV bp el	(18148-7, LN, "Left Ventricular End Systolic Volume")	(G-C036, SRT, "Measurement Method") = (125211, DCM, "Biplane Ellipse")
EF(bp el) Alias: LVEF BP-EL	(18043-0, LN, "Left Ventricular Ejection Fraction")	(G-C036, SRT, "Measurement Method") = (125211, DCM, "Biplane Ellipse")
SV(bp el) Alias: SV bp el	(F-32120, SRT, "Stroke Volume")	(G-C0E3, SRT, "Finding Site") = (T-32600, SRT, "Left Ventricle") (G-C036, SRT, "Measurement Method") = (125211, DCM, "Biplane Ellipse")
SI(bp el)	(F-00078, SRT, "Stroke	(G-C0E3, SRT, "Finding Site") =

Alias: SI bp el	Index")	(T-32600, SRT, "Left Ventricle") (G-C036, SRT, "Measurement Method") = (125211, DCM, "Biplane Ellipse")
CO(bp el) Alias: CO bp el	(F-32100, SRT, "Cardiac Output")	(G-C0E3, SRT, "Finding Site") = (T-32600, SRT, "Left Ventricle") (G-C036, SRT, "Measurement Method") = (125211, DCM, "Biplane Ellipse")
CI(bp el) Alias: CI bp el	(F-32110, SRT, "Cardiac Index")	(G-C0E3, SRT, "Finding Site") = (T-32600, SRT, "Left Ventricle") (G-C036, SRT, "Measurement Method") = (125211, DCM, "Biplane Ellipse")
LVd Mass(A-L) Alias: LVd Mass A-L	(18087-7, LN, "Left Ventricle Mass")	(R-4089A, SRT, "Cardiac Cycle Point") = (F-32010, SRT, "Diastole") (G-C036, SRT, "Measurement Method") = (125205, DCM, "Area-Length Single Plane")
LVs Mass(A-L) Alias: LVs Mass A-L	(18087-7, LN, "Left Ventricle Mass")	(R-4089A, SRT, "Cardiac Cycle Point") = (F-32020, SRT, "Systole") (G-C036, SRT, "Measurement Method") = (125205, DCM, "Area-Length Single Plane")
LVd Mass Index(A-L) Alias: LVd Mass I A-L	(GEU-106-0028, 99GEMS, "Left Ventricle Mass Index")	(R-4089A, SRT, "Cardiac Cycle Point") = (F-32010, SRT, "Diastole") (G-C036, SRT, "Measurement Method") = (125205, DCM, "Area-Length Single Plane")
MM/IVSd Alias: IVSd	(18154-5, LN, "Interventricular Septum Diastolic Thickness")	(G-0373, SRT, "Image Mode") = (G-0394, SRT, "M mode")
MM/IVSs Alias: IVSs	(18158-6, LN, "Interventricular Septum Systolic Thickness")	(G-0373, SRT, "Image Mode") = (G-0394, SRT, "M mode")
MM/LVIDd Alias: LVIDd	(29436-3, LN, "Left Ventricle Internal End Diastolic Dimension")	(G-0373, SRT, "Image Mode") = (G-0394, SRT, "M mode")
MM/LVIDs	(29438-9, LN, "Left	(G-0373, SRT, "Image Mode") =



Alias: LVIDs	Ventricle Internal Systolic Dimension")	(G-0394, SRT, "M mode")
MM/LVPWd Alias: LVPWd	(18152-9, LN, "Left Ventricle Posterior Wall Diastolic Thickness")	(G-0373, SRT, "Image Mode") = (G-0394, SRT, "M mode")
MM/LVPWs Alias: LVPWs	(18156-0, LN, "Left Ventricle Posterior Wall Systolic Thickness")	(G-0373, SRT, "Image Mode") = (G-0394, SRT, "M mode")
MM/EDV(Teich) Alias: EDV(Teich)	(18026-5, LN, "Left Ventricular End Diastolic Volume")	(G-0373, SRT, "Image Mode") = (G-0394, SRT, "M mode") (G-C036, SRT, "Measurement Method") = (125209, DCM, "Teichholz")
MM/ESV(Teich) Alias: ESV(Teich)	(18148-7, LN, "Left Ventricular End Systolic Volume")	(G-0373, SRT, "Image Mode") = (G-0394, SRT, "M mode") (G-C036, SRT, "Measurement Method") = (125209, DCM, "Teichholz")
MM/EF(Teich) Alias: EF(Teich)	(18043-0, LN, "Left Ventricular Ejection Fraction")	(G-0373, SRT, "Image Mode") = (G-0394, SRT, "M mode") (G-C036, SRT, "Measurement Method") = (125209, DCM, "Teichholz")
MM/SV(Teich) Alias: SV(Teich)	(F-32120, SRT, "Stroke Volume")	(G-C0E3, SRT, "Finding Site") = (T-32600, SRT, "Left Ventricle") (G-0373, SRT, "Image Mode") = (G-0394, SRT, "M mode") (G-C036, SRT, "Measurement Method") = (125209, DCM, "Teichholz")
MM/SI(Teich) Alias: SI(Teich)	(F-00078, SRT, "Stroke Index")	(G-C0E3, SRT, "Finding Site") = (T-32600, SRT, "Left Ventricle") (G-0373, SRT, "Image Mode") = (G-0394, SRT, "M mode") (G-C036, SRT, "Measurement Method") = (125209, DCM, "Teichholz")
MM/CO(Teich) Alias: CO(Teich)	(F-32100, SRT, "Cardiac Output")	(G-C0E3, SRT, "Finding Site") = (T-32600, SRT, "Left Ventricle") (G-0373, SRT, "Image Mode") = (G-0394, SRT, "M mode") (G-C036, SRT, "Measurement Method") = (125209, DCM, "Teichholz")

		Method") = (125209, DCM, "Teichholz")
MM/CI(Teich) Alias: CI(Teich)	(F-32110, SRT, "Cardiac Index")	(G-C0E3, SRT, "Finding Site") = (T-32600, SRT, "Left Ventricle") (G-0373, SRT, "Image Mode") = (G-0394, SRT, "M mode") (G-C036, SRT, "Measurement Method") = (125209, DCM, "Teichholz")
MM/EDV(Cube) Alias: EDV(Cube)	(18026-5, LN, "Left Ventricular End Diastolic Volume")	(G-0373, SRT, "Image Mode") = (G-0394, SRT, "M mode") (G-C036, SRT, "Measurement Method") = (125206, DCM, "Cube Method")
MM/ESV(Cube) Alias: ESV(Cube)	(18148-7, LN, "Left Ventricular End Systolic Volume")	(G-0373, SRT, "Image Mode") = (G-0394, SRT, "M mode") (G-C036, SRT, "Measurement Method") = (125206, DCM, "Cube Method")
MM/EF(Cube) Alias: EF(Cube)	(18043-0, LN, "Left Ventricular Ejection Fraction")	(G-0373, SRT, "Image Mode") = (G-0394, SRT, "M mode") (G-C036, SRT, "Measurement Method") = (125206, DCM, "Cube Method")
MM/SV(Cube) Alias: SV(Cube)	(F-32120, SRT, "Stroke Volume")	(G-C0E3, SRT, "Finding Site") = (T-32600, SRT, "Left Ventricle") (G-0373, SRT, "Image Mode") = (G-0394, SRT, "M mode") (G-C036, SRT, "Measurement Method") = (125206, DCM, "Cube Method")
MM/SI(Cube) Alias: SI(Cube)	(F-00078, SRT, "Stroke Index")	(G-C0E3, SRT, "Finding Site") = (T-32600, SRT, "Left Ventricle") (G-0373, SRT, "Image Mode") = (G-0394, SRT, "M mode") (G-C036, SRT, "Measurement Method") = (125206, DCM, "Cube Method")
MM/CO(Cube) Alias: CO(Cube)	(F-32100, SRT, "Cardiac Output")	(G-C0E3, SRT, "Finding Site") = (T-32600, SRT, "Left Ventricle") (G-0373, SRT, "Image Mode") = (G-0394, SRT, "M mode") (G-C036, SRT, "Measurement Method") = (125206, DCM, "Cube Method")

		Method")
MM/CI(Cube) Alias: CI(Cube)	(F-32110, SRT, "Cardiac Index")	(G-C0E3, SRT, "Finding Site") = (T-32600, SRT, "Left Ventricle") (G-0373, SRT, "Image Mode") = (G-0394, SRT, "M mode") (G-C036, SRT, "Measurement Method") = (125206, DCM, "Cube Method")
MM/%FS Alias: %FS	(18051-3, LN, "Left Ventricular Fractional Shortening")	(G-0373, SRT, "Image Mode") = (G-0394, SRT, "M mode")
MM/IVSd/LVPWd Alias: IVSd/LVPWd	(18155-2, LN, "Interventricular Septum to Posterior Wall Thickness Ratio")	(G-0373, SRT, "Image Mode") = (G-0394, SRT, "M mode") (R-4089A, SRT, "Cardiac Cycle Point") = (F-32010, SRT, "Diastole")
MM/%LVPW Thck Alias: %LVPW Thck	(18053-9, LN, "Left Ventricle Posterior Wall % Thickening")	(G-0373, SRT, "Image Mode") = (G-0394, SRT, "M mode")
MM/LVd Mass Alias: LVd Mass	(18087-7, LN, "Left Ventricle Mass")	(G-0373, SRT, "Image Mode") = (G-0394, SRT, "M mode") (R-4089A, SRT, "Cardiac Cycle Point") = (F-32010, SRT, "Diastole")
MM/LVs Mass Alias: LVs Mass	(18087-7, LN, "Left Ventricle Mass")	(G-0373, SRT, "Image Mode") = (G-0394, SRT, "M mode") (R-4089A, SRT, "Cardiac Cycle Point") = (F-32020, SRT, "Systole")
MM/LVd Mass/ASE Alias: LVd Mass (ASE)	(18087-7, LN, "Left Ventricle Mass")	(G-0373, SRT, "Image Mode") = (G-0394, SRT, "M mode") (R-4089A, SRT, "Cardiac Cycle Point") = (F-32010, SRT, "Diastole") (G-C036, SRT, "Measurement Method") = (125221, DCM, "Left Ventricle Mass by M-mode")
MM/LVs Mass/ASE Alias: LVs Mass (ASE)	(18087-7, LN, "Left Ventricle Mass")	(G-0373, SRT, "Image Mode") = (G-0394, SRT, "M mode") (R-4089A, SRT, "Cardiac Cycle Point") = (F-32020, SRT, "Systole") (G-C036, SRT, "Measurement Method") = (125221, DCM, "Left

		Ventricle Mass by M-mode")
MM/HeartRate Alias: HR	(8867-4, LN, "Heart rate")	(G-0373, SRT, "Image Mode") = (G-0394, SRT, "M mode")
SD/HeartRate Alias: HR	(8867-4, LN, "Heart rate")	(G-0373, SRT, "Image Mode") = (R-409E4, SRT, "Doppler Pulsed")
SD/HeartRate/Calc Alias: HR	(8867-4, LN, "Heart rate")	(G-0373, SRT, "Image Mode") = (R-409E4, SRT, "Doppler Pulsed")
IVCT Alias: IVCT	(G-037E, SRT, "Left Ventricular Isovolumic Contraction Time")	
IVRT Alias: IVRT	(18071-1, LN, "Left Ventricular Isovolumic Relaxation Time")	
MP/LVOT Diam Alias: LVOT Diam	(G-038F, SRT, "Cardiovascular Orifice Diameter")	(G-C0E3, SRT, "Finding Site") = (T-32650, SRT, "Left Ventricle Outflow Tract")
MP/LVOT VTI Alias: LVOT VTI	(20354-7, LN, "Velocity Time Integral")	(G-C0E3, SRT, "Finding Site") = (T-32650, SRT, "Left Ventricle Outflow Tract")
LVOT Vmax Alias: LVOT Vmax	(11726-7, LN, "Peak Velocity")	(G-C0E3, SRT, "Finding Site") = (T-32650, SRT, "Left Ventricle Outflow Tract")
LVOT Vmax P Alias: LVOT Vmax	(11726-7, LN, "Peak Velocity")	(G-C0E3, SRT, "Finding Site") = (T-32650, SRT, "Left Ventricle Outflow Tract")
LVOT maxPG Alias: LVOT maxPG	(20247-3, LN, "Peak Gradient")	(G-C0E3, SRT, "Finding Site") = (T-32650, SRT, "Left Ventricle Outflow Tract")
LVOT Vmean Alias: LVOT Vmean	(20352-1, LN, "Mean Velocity")	(G-C0E3, SRT, "Finding Site") = (T-32650, SRT, "Left Ventricle Outflow Tract")
LVOT meanPG	(20256-4, LN, "Mean Gradient")	(G-C0E3, SRT, "Finding Site") = (T-32650, SRT, "Left Ventricle

<b>Alias: LVOT meanPG</b>		<b>Outflow Tract")</b>
<b>LVOT VTI</b> <b>Alias: LVOT VTI</b>	<b>(20354-7, LN, "Velocity Time Integral")</b>	<b>(G-C0E3, SRT, "Finding Site") = (T-32650, SRT, "Left Ventricle Outflow Tract")</b>
<b>LVOT HR</b> <b>Alias: HR</b>	<b>(8867-4, LN, "Heart rate")</b>	
<b>LVOT SV</b> <b>Alias: LVSV Dopp</b>	<b>(F-32120, SRT, "Stroke Volume")</b>	<b>(G-C0E3, SRT, "Finding Site") = (T-32650, SRT, "Left Ventricle Outflow Tract")</b>
<b>LVOT SI</b> <b>Alias: LVSI Dopp</b>	<b>(F-00078, SRT, "Stroke Index")</b>	<b>(G-C0E3, SRT, "Finding Site") = (T-32650, SRT, "Left Ventricle Outflow Tract")</b>
<b>LVOT CO</b> <b>Alias: LVCO Dopp</b>	<b>(F-32100, SRT, "Cardiac Output")</b>	<b>(G-C0E3, SRT, "Finding Site") = (T-32650, SRT, "Left Ventricle Outflow Tract")</b>
<b>LVOT CI</b> <b>Alias: LVCI Dopp</b>	<b>(F-32110, SRT, "Cardiac Index")</b>	<b>(G-C0E3, SRT, "Finding Site") = (T-32650, SRT, "Left Ventricle Outflow Tract")</b>
<b>LIMP</b> <b>Alias: LIMP</b>	<b>(G-037F, SRT, "Left Ventricular Index of Myocardial Performance")</b>	
<b>AP/LVOT Diam</b> <b>Alias: LVOT Diam</b>	<b>(G-038F, SRT, "Cardiovascular Orifice Diameter")</b>	<b>(G-C0E3, SRT, "Finding Site") = (T-32650, SRT, "Left Ventricle Outflow Tract")</b>
<b>AP/LVOT VTI</b> <b>Alias: LVOT VTI</b>	<b>(20354-7, LN, "Velocity Time Integral")</b>	<b>(G-C0E3, SRT, "Finding Site") = (T-32650, SRT, "Left Ventricle Outflow Tract")</b>
<b>ECG/HeartRate</b> <b>Alias: HR</b>	<b>(8867-4, LN, "Heart rate")</b>	
<b>LVEDV(4D)</b> <b>Alias: EDV</b>	<b>(18026-5, LN, "Left Ventricular End Diastolic Volume")</b>	<b>(G-0373, SRT, "Image Mode") = (125231, DCM, "3D mode") (G-C036, SRT, "Measurement Method") = (GEU-106-0023, 99GEMS, "4D Auto Left Ventricle Quantification")</b>

<p><b>LVESV(4D)</b>  <b>Alias: ESV</b></p>	<p><b>(18148-7, LN, "Left Ventricular End Systolic Volume")</b></p>	<p><b>(G-0373, SRT, "Image Mode") = (125231, DCM, "3D mode")</b>  <b>(G-C036, SRT, "Measurement Method") = (GEU-106-0023, 99GEMS, "4D Auto Left Ventricle Quantification")</b></p>
<p><b>EF(4D)</b>  <b>Alias: EF</b></p>	<p><b>(18043-0, LN, "Left Ventricular Ejection Fraction")</b></p>	<p><b>(G-0373, SRT, "Image Mode") = (125231, DCM, "3D mode")</b>  <b>(G-C036, SRT, "Measurement Method") = (GEU-106-0023, 99GEMS, "4D Auto Left Ventricle Quantification")</b></p>
<p><b>SV(4D)</b>  <b>Alias: SV</b></p>	<p><b>(F-32120, SRT, "Stroke Volume")</b></p>	<p><b>(G-0373, SRT, "Image Mode") = (125231, DCM, "3D mode")</b>  <b>(G-C036, SRT, "Measurement Method") = (GEU-106-0023, 99GEMS, "4D Auto Left Ventricle Quantification")</b></p>
<p><b>CO(4D)</b>  <b>Alias: CO</b></p>	<p><b>(F-32100, SRT, "Cardiac Output")</b></p>	<p><b>(G-0373, SRT, "Image Mode") = (125231, DCM, "3D mode")</b>  <b>(G-C036, SRT, "Measurement Method") = (GEU-106-0023, 99GEMS, "4D Auto Left Ventricle Quantification")</b></p>
<p><b>AWMA/GPeakSysSL(A2C)</b>  <b>Alias: G peak SL(A2C)</b></p>	<p><b>(GEU-106-0001, 99GEMS, "Global Peak Longitudinal Strain")</b></p>	<p><b>(111031, DCM, "Image View") = (G-A19B, SRT, "Apical two chamber")</b>  <b>(G-C036, SRT, "Measurement Method") = (GEU-106-0018, 99GEMS, "AFI")</b></p>
<p><b>AWMA/GPeakSysSL(A4C)</b>  <b>Alias: G peak SL(A4C)</b></p>	<p><b>(GEU-106-0001, 99GEMS, "Global Peak Longitudinal Strain")</b></p>	<p><b>(111031, DCM, "Image View") = (G-A19C, SRT, "Apical four chamber")</b>  <b>(G-C036, SRT, "Measurement Method") = (GEU-106-0018, 99GEMS, "AFI")</b></p>
<p><b>AWMA/GPeakSysSL(APLAX)</b>  <b>Alias: G peak SL(APLAX)</b></p>	<p><b>(GEU-106-0001, 99GEMS, "Global Peak Longitudinal Strain")</b></p>	<p><b>(111031, DCM, "Image View") = (G-0395, SRT, "Apical long axis")</b>  <b>(G-C036, SRT, "Measurement Method") = (GEU-106-0018, 99GEMS, "AFI")</b></p>
<p><b>AWMA/GPeakSysSL(Avg)</b></p>	<p><b>(GEU-106-0001, 99GEMS, "Global Peak Longitudinal Strain")</b></p>	<p><b>(G-C036, SRT, "Measurement Method") = (GEU-106-0018, 99GEMS, "AFI")</b></p>

Alias: G peak SL(Avg)	Strain")	99GEMS, "AFI")
<p><b>AWMA/AVC</b>   <b>Alias: AVC</b></p>	<p>(GEU-106-0003, 99GEMS,  "Aortic Valve Closure")</p>	<p>(G-C036, SRT, "Measurement Method") = (GEU-106-0018, 99GEMS, "AFI")</p>
<p><b>AWMA/BS PeakSysSL</b>   <b>Alias: BS peak sys SL</b></p>	<p>(GEU-106-0002, 99GEMS,  "Peak Longitudinal Strain")</p>	<p>(G-C0E3, SRT, "Finding Site") = (R-10076, SRT, "left ventricle basal inferoseptal segment")  (R-4089A, SRT, "Cardiac Cycle Point") = (F-32020, SRT, "Systole")  (G-C036, SRT, "Measurement Method") = (GEU-106-0018, 99GEMS, "AFI")</p>
<p><b>AWMA/MS PeakSysSL</b>   <b>Alias: MS peak sys SL</b></p>	<p>(GEU-106-0002, 99GEMS,  "Peak Longitudinal Strain")</p>	<p>(G-C0E3, SRT, "Finding Site") = (R-10078, SRT, "left ventricle mid inferoseptal segment")  (R-4089A, SRT, "Cardiac Cycle Point") = (F-32020, SRT, "Systole")  (G-C036, SRT, "Measurement Method") = (GEU-106-0018, 99GEMS, "AFI")</p>
<p><b>AWMA/AS PeakSysSL</b>   <b>Alias: AS peak sys SL</b></p>	<p>(GEU-106-0002, 99GEMS,  "Peak Longitudinal Strain")</p>	<p>(G-C0E3, SRT, "Finding Site") = (T-32614, SRT, "left ventricle apical septal segment")  (R-4089A, SRT, "Cardiac Cycle Point") = (F-32020, SRT, "Systole")  (G-C036, SRT, "Measurement Method") = (GEU-106-0018, 99GEMS, "AFI")</p>
<p><b>AWMA/BL PeakSysSL</b>   <b>Alias: BL peak sys SL</b></p>	<p>(GEU-106-0002, 99GEMS,  "Peak Longitudinal Strain")</p>	<p>(G-C0E3, SRT, "Finding Site") = (R-1007A, SRT, "left ventricle basal anterolateral segment")  (R-4089A, SRT, "Cardiac Cycle Point") = (F-32020, SRT, "Systole")  (G-C036, SRT, "Measurement Method") = (GEU-106-0018, 99GEMS, "AFI")</p>
<p><b>AWMA/ML PeakSysSL</b>   <b>Alias: ML peak sys SL</b></p>	<p>(GEU-106-0002, 99GEMS,  "Peak Longitudinal Strain")</p>	<p>(G-C0E3, SRT, "Finding Site") = (R-1007C, SRT, "left ventricle mid anterolateral segment")  (R-4089A, SRT, "Cardiac Cycle Point") = (F-32020, SRT, "Systole")  (G-C036, SRT, "Measurement Method") = (GEU-106-0018, 99GEMS, "AFI")</p>

<p><b>AWMA/AL PeakSysSL</b>   <b>Alias: AL peak sys SL</b></p>	<p><b>(GEU-106-0002, 99GEMS, "Peak Longitudinal Strain")</b></p>	<p><b>(G-C0E3, SRT, "Finding Site") = (T-3261C, SRT, "left ventricle apical lateral segment") (R-4089A, SRT, "Cardiac Cycle Point") = (F-32020, SRT, "Systole") (G-C036, SRT, "Measurement Method") = (GEU-106-0018, 99GEMS, "AFI")</b></p>
<p><b>AWMA/BI PeakSysSL</b>   <b>Alias: BI peak sys SL</b></p>	<p><b>(GEU-106-0002, 99GEMS, "Peak Longitudinal Strain")</b></p>	<p><b>(G-C0E3, SRT, "Finding Site") = (T-32615, SRT, "left ventricle basal inferior segment") (R-4089A, SRT, "Cardiac Cycle Point") = (F-32020, SRT, "Systole") (G-C036, SRT, "Measurement Method") = (GEU-106-0018, 99GEMS, "AFI")</b></p>
<p><b>AWMA/MI PeakSysSL</b>   <b>Alias: MI peak sys SL</b></p>	<p><b>(GEU-106-0002, 99GEMS, "Peak Longitudinal Strain")</b></p>	<p><b>(G-C0E3, SRT, "Finding Site") = (T-32616, SRT, "left ventricle mid inferior segment") (R-4089A, SRT, "Cardiac Cycle Point") = (F-32020, SRT, "Systole") (G-C036, SRT, "Measurement Method") = (GEU-106-0018, 99GEMS, "AFI")</b></p>
<p><b>AWMA/AI PeakSysSL</b>   <b>Alias: AI peak sys SL</b></p>	<p><b>(GEU-106-0002, 99GEMS, "Peak Longitudinal Strain")</b></p>	<p><b>(G-C0E3, SRT, "Finding Site") = (T-32618, SRT, "left ventricle apical inferior segment") (R-4089A, SRT, "Cardiac Cycle Point") = (F-32020, SRT, "Systole") (G-C036, SRT, "Measurement Method") = (GEU-106-0018, 99GEMS, "AFI")</b></p>
<p><b>AWMA/BA PeakSysSL</b>   <b>Alias: BA peak sys SL</b></p>	<p><b>(GEU-106-0002, 99GEMS, "Peak Longitudinal Strain")</b></p>	<p><b>(G-C0E3, SRT, "Finding Site") = (T-32619, SRT, "left ventricle basal anterior segment") (R-4089A, SRT, "Cardiac Cycle Point") = (F-32020, SRT, "Systole") (G-C036, SRT, "Measurement Method") = (GEU-106-0018, 99GEMS, "AFI")</b></p>
<p><b>AWMA/MA PeakSysSL</b>   <b>Alias: MA peak sys SL</b></p>	<p><b>(GEU-106-0002, 99GEMS, "Peak Longitudinal Strain")</b></p>	<p><b>(G-C0E3, SRT, "Finding Site") = (T-32617, SRT, "left ventricle mid anterior segment") (R-4089A, SRT, "Cardiac Cycle Point") = (F-32020, SRT, "Systole") (G-C036, SRT, "Measurement Method") = (GEU-106-0018, 99GEMS, "AFI")</b></p>



		Method") = (GEU-106-0018, 99GEMS, "AFI")
AWMA/AA PeakSysSL Alias: AA peak sys SL	(GEU-106-0002, 99GEMS, "Peak Longitudinal Strain")	(G-C0E3, SRT, "Finding Site") = (T-32613, SRT, "left ventricle apical anterior segment") (R-4089A, SRT, "Cardiac Cycle Point") = (F-32020, SRT, "Systole") (G-C036, SRT, "Measurement Method") = (GEU-106-0018, 99GEMS, "AFI")
AWMA/BP PeakSysSL Alias: BP peak sys SL	(GEU-106-0002, 99GEMS, "Peak Longitudinal Strain")	(G-C0E3, SRT, "Finding Site") = (R-10079, SRT, "left ventricle basal inferolateral segment") (R-4089A, SRT, "Cardiac Cycle Point") = (F-32020, SRT, "Systole") (G-C036, SRT, "Measurement Method") = (GEU-106-0018, 99GEMS, "AFI")
AWMA/MP PeakSysSL Alias: MP peak sys SL	(GEU-106-0002, 99GEMS, "Peak Longitudinal Strain")	(G-C0E3, SRT, "Finding Site") = (R-1007B, SRT, "left ventricle mid inferolateral segment") (R-4089A, SRT, "Cardiac Cycle Point") = (F-32020, SRT, "Systole") (G-C036, SRT, "Measurement Method") = (GEU-106-0018, 99GEMS, "AFI")
AWMA/AP PeakSysSL Alias: AP peak sys SL	(GEU-106-0002, 99GEMS, "Peak Longitudinal Strain")	(G-C0E3, SRT, "Finding Site") = (GEU-106-0025, 99GEMS, "left ventricle apical posterior segment") (R-4089A, SRT, "Cardiac Cycle Point") = (F-32020, SRT, "Systole") (G-C036, SRT, "Measurement Method") = (GEU-106-0018, 99GEMS, "AFI")
AWMA/BAS PeakSysSL Alias: BAS peak sys SL	(GEU-106-0002, 99GEMS, "Peak Longitudinal Strain")	(G-C0E3, SRT, "Finding Site") = (R-10075, SRT, "left ventricle basal anteroseptal segment") (R-4089A, SRT, "Cardiac Cycle Point") = (F-32020, SRT, "Systole") (G-C036, SRT, "Measurement Method") = (GEU-106-0018, 99GEMS, "AFI")
AWMA/MAS PeakSysSL	(GEU-106-0002, 99GEMS, "Peak Longitudinal Strain")	(G-C0E3, SRT, "Finding Site") = (R-10077, SRT, "left ventricle mid anteroseptal segment")

Alias: MAS peak sys SL		(R-4089A, SRT, "Cardiac Cycle Point") = (F-32020, SRT, "Systole") (G-C036, SRT, "Measurement Method") = (GEU-106-0018, 99GEMS, "AFI")
AWMA/AAS PeakSysSL Alias: AAS peak sys SL	(GEU-106-0002, 99GEMS, "Peak Longitudinal Strain")	(G-C0E3, SRT, "Finding Site") = (GEU-106-0026, 99GEMS, "left ventricle apical anteroseptal segment") (R-4089A, SRT, "Cardiac Cycle Point") = (F-32020, SRT, "Systole") (G-C036, SRT, "Measurement Method") = (GEU-106-0018, 99GEMS, "AFI")

Section Right Ventricle

GEU Parameter ID (and corresponding alias)	Base Measurement Concept Name	Concept or Acquisition Context Modifier
TomTec/RVFunction/EDV Alias: RVEDV(TomTec)	(8822-3, LN, "Right Ventricular ED Volume")	(G-C036, SRT, "Measurement Method") = (GEU-106-0022, 99GEMS, "4D Right Ventricle Volume")
TomTec/RVFunction/ESV Alias: RVESV(TomTec)	(8824-5, LN, "Right Ventricular ES Volume")	(G-C036, SRT, "Measurement Method") = (GEU-106-0022, 99GEMS, "4D Right Ventricle Volume")
TomTec/RVFunction/SV Alias: RVSV(TomTec)	(F-32120, SRT, "Stroke Volume")	(G-C036, SRT, "Measurement Method") = (GEU-106-0022, 99GEMS, "4D Right Ventricle Volume")
TomTec/RVFunction/EF Alias: RVEF(TomTec)	(10231-9, LN, "RV Ejection Fraction")	(G-C036, SRT, "Measurement Method") = (GEU-106-0022, 99GEMS, "4D Right Ventricle Volume")
MM/RVOT Alias: RVOT	(G-038F, SRT, "Cardiovascular Orifice Diameter")	(G-C0E3, SRT, "Finding Site") = (T-32550, SRT, "Right Ventricle Outflow Tract") (G-0373, SRT, "Image Mode") = (G-0394, SRT, "M mode")
2D/RVOT Diam Alias: RVOT Diam	(G-038F, SRT, "Cardiovascular Orifice Diameter")	(G-C0E3, SRT, "Finding Site") = (T-32550, SRT, "Right Ventricle Outflow Tract") (G-0373, SRT, "Image Mode") = (G-03A2, SRT, "2D mode") or (R-409E2,

		SRT, "Doppler Color Flow") depending on scan mode
<b>2D/RVAWd</b> Alias: RVAWd	(18153-7, LN, "Right Ventricular Anterior Wall Diastolic Thickness")	(G-0373, SRT, "Image Mode") = (G-03A2, SRT, "2D mode") or (R-409E2, SRT, "Doppler Color Flow") depending on scan mode
<b>2D/RVAWs</b> Alias: RVAWs	(18157-8, LN, "Right Ventricular Anterior Wall Systolic Thickness")	(G-0373, SRT, "Image Mode") = (G-03A2, SRT, "2D mode") or (R-409E2, SRT, "Doppler Color Flow") depending on scan mode
<b>2D/RVIDd</b> Alias: RVIDd	(20304-2, LN, "Right Ventricular Internal Diastolic Dimension")	
<b>2D/RVIDs</b> Alias: RVIDs	(20305-9, LN, "Right Ventricular Internal Systolic Dimension")	(G-0373, SRT, "Image Mode") = (G-03A2, SRT, "2D mode") or (R-409E2, SRT, "Doppler Color Flow") depending on scan mode
<b>2D/RVD Major</b> Alias: RV Major	(G-A193, SRT, "Major Axis")	(G-0373, SRT, "Image Mode") = (G-03A2, SRT, "2D mode") or (R-409E2, SRT, "Doppler Color Flow") depending on scan mode
<b>2D/RVD Minor</b> Alias: RV Minor	(G-A194, SRT, "Minor Axis")	(G-0373, SRT, "Image Mode") = (G-03A2, SRT, "2D mode") or (R-409E2, SRT, "Doppler Color Flow") depending on scan mode
<b>2D/RVOT Area</b> Alias: RVOT Area	(G-038E, SRT, "Cardiovascular Orifice Area")	(G-C0E3, SRT, "Finding Site") = (T-32550, SRT, "Right Ventricle Outflow Tract") (G-0373, SRT, "Image Mode") = (G-03A2, SRT, "2D mode") or (R-409E2, SRT, "Doppler Color Flow") depending on scan mode
<b>RVLd(A4C)</b> Alias: RVLd(A4C)	(18078-6, LN, "Right Ventricular Major Axis Diastolic Dimension")	(111031, DCM, "Image View") = (G-A19C, SRT, "Apical four chamber")
<b>RVAd(A4C)</b> Alias: RVAd(A4C)	(G-A166, SRT, "Area")	(111031, DCM, "Image View") = (G-A19C, SRT, "Apical four chamber") (R-4089A, SRT, "Cardiac Cycle Point") = (F-32010, SRT, "Diastole")

<b>RVEDV(A-L A4C)</b> Alias: RVEDV A-L A4C	(8822-3, LN, "Right Ventricular ED Volume")	(111031, DCM, "Image View") = (G-A19C, SRT, "Apical four chamber") (G-C036, SRT, "Measurement Method") = (125205, DCM, "Area-Length Single Plane")
<b>RVEDV(MOD A4C)</b> Alias: RVEDV(MOD A4C)	(8822-3, LN, "Right Ventricular ED Volume")	(111031, DCM, "Image View") = (G-A19C, SRT, "Apical four chamber") (G-C036, SRT, "Measurement Method") = (125208, DCM, "Method of Disks, Single Plane")
<b>RVLs(A4C)</b> Alias: RVLs(A4C)	(18079-4, LN, "Right Ventricular Major Axis Systolic Dimension")	(111031, DCM, "Image View") = (G-A19C, SRT, "Apical four chamber")
<b>RVAs(A4C)</b> Alias: RVAs(A4C)	(G-A166, SRT, "Area")	(111031, DCM, "Image View") = (G-A19C, SRT, "Apical four chamber") (R-4089A, SRT, "Cardiac Cycle Point") = (F-32020, SRT, "Systole")
<b>RVESV(A-L A4C)</b> Alias: RVESV A-L A4C	(8824-5, LN, "Right Ventricular ES Volume")	(111031, DCM, "Image View") = (G-A19C, SRT, "Apical four chamber") (G-C036, SRT, "Measurement Method") = (125205, DCM, "Area-Length Single Plane")
<b>RVESV(MOD A4C)</b> Alias: RVESV(MOD A4C)	(8824-5, LN, "Right Ventricular ES Volume")	(111031, DCM, "Image View") = (G-A19C, SRT, "Apical four chamber") (G-C036, SRT, "Measurement Method") = (125208, DCM, "Method of Disks, Single Plane")
<b>MM/RVIDd</b> Alias: RVIDd	(20304-2, LN, "Right Ventricular Internal Diastolic Dimension")	(G-0373, SRT, "Image Mode") = (G-0394, SRT, "M mode")
<b>MM/RVIDs</b> Alias: RVIDs	(20305-9, LN, "Right Ventricular Internal Systolic Dimension")	(G-0373, SRT, "Image Mode") = (G-0394, SRT, "M mode")
<b>MM/RVAWd</b> Alias: RVAWd	(18153-7, LN, "Right Ventricular Anterior Wall Diastolic Thickness")	(G-0373, SRT, "Image Mode") = (G-0394, SRT, "M mode")
<b>MM/RVAWs</b> Alias: RVAWs	(18157-8, LN, "Right Ventricular Anterior Wall Systolic Thickness")	(G-0373, SRT, "Image Mode") = (G-0394, SRT, "M mode")

<b>Est RVSP</b> Alias: RVSP	(G-0380, SRT, "Right Ventricular Peak Systolic Pressure")	
<b>RVOT Vmax</b> Alias: RVOT Vmax	(11726-7, LN, "Peak Velocity")	(G-C0E3, SRT, "Finding Site") = (T-32550, SRT, "Right Ventricle Outflow Tract")
<b>RVOT Vmax P</b> Alias: RVOT Vmax	(11726-7, LN, "Peak Velocity")	(G-C0E3, SRT, "Finding Site") = (T-32550, SRT, "Right Ventricle Outflow Tract")
<b>RVOT maxPG</b> Alias: RVOT maxPG	(20247-3, LN, "Peak Gradient")	(G-C0E3, SRT, "Finding Site") = (T-32550, SRT, "Right Ventricle Outflow Tract")
<b>RVOT Vmean</b> Alias: RVOT Vmean	(20352-1, LN, "Mean Velocity")	(G-C0E3, SRT, "Finding Site") = (T-32550, SRT, "Right Ventricle Outflow Tract")
<b>RVOT meanPG</b> Alias: RVOT meanPG	(20256-4, LN, "Mean Gradient")	(G-C0E3, SRT, "Finding Site") = (T-32550, SRT, "Right Ventricle Outflow Tract")
<b>RVOT VTI</b> Alias: RVOT VTI	(20354-7, LN, "Velocity Time Integral")	(G-C0E3, SRT, "Finding Site") = (T-32550, SRT, "Right Ventricle Outflow Tract")
<b>RVOT HR</b> Alias: HR	(8867-4, LN, "Heart rate")	
<b>RVOT SV</b> Alias: RVOT SV	(F-32120, SRT, "Stroke Volume")	(G-C0E3, SRT, "Finding Site") = (T-32550, SRT, "Right Ventricle Outflow Tract")
<b>RVOT SI</b> Alias: RVOT SI	(F-00078, SRT, "Stroke Index")	(G-C0E3, SRT, "Finding Site") = (T-32550, SRT, "Right Ventricle Outflow Tract")
<b>RVOT CO</b> Alias: RVOT CO	(F-32100, SRT, "Cardiac Output")	(G-C0E3, SRT, "Finding Site") = (T-32550, SRT, "Right Ventricle Outflow Tract")
<b>RVOT CI</b> Alias: RVOT CI	(F-32110, SRT, "Cardiac Index")	(G-C0E3, SRT, "Finding Site") = (T-32550, SRT, "Right Ventricle Outflow Tract")

<b>RIMP</b> Alias: RIMP	(G-0381, SRT, "Right Ventricular Index of Myocardial Performance")	
----------------------------	--	--

**Section Left Atrium**

GEU Parameter ID (and corresponding alias)	Base Measurement Concept Name	Concept or Acquisition Context Modifier
<b>2D/Ao/LA</b> Alias: Ao/LA	(17985-3, LN, "Left Atrium to Aortic Root Ratio")	(G-0373, SRT, "Image Mode") = (G-03A2, SRT, "2D mode") or (R-409E2, SRT, "Doppler Color Flow") depending on scan mode
<b>MM/Ao/LA</b> Alias: Ao/LA	(17985-3, LN, "Left Atrium to Aortic Root Ratio")	(G-0373, SRT, "Image Mode") = (G-0394, SRT, "M mode")
<b>MM/LAAo/LA/Ao</b> Alias: LA/Ao	(17985-3, LN, "Left Atrium to Aortic Root Ratio")	(G-0373, SRT, "Image Mode") = (G-0394, SRT, "M mode")
<b>MM/LAAo/Ao/LA</b> Alias: Ao/LA	(17985-3, LN, "Left Atrium to Aortic Root Ratio")	(G-0373, SRT, "Image Mode") = (G-0394, SRT, "M mode")
<b>2D/LA Major</b> Alias: LA Major	(G-A193, SRT, "Major Axis")	(G-0373, SRT, "Image Mode") = (G-03A2, SRT, "2D mode") or (R-409E2, SRT, "Doppler Color Flow") depending on scan mode
<b>2D/LA Minor</b> Alias: LA Minor	(G-A194, SRT, "Minor Axis")	(G-0373, SRT, "Image Mode") = (G-03A2, SRT, "2D mode") or (R-409E2, SRT, "Doppler Color Flow") depending on scan mode
<b>2D/LA</b> Alias: LA Diam	(M-02550, SRT, "Diameter")	(G-0373, SRT, "Image Mode") = (G-03A2, SRT, "2D mode") or (R-409E2, SRT, "Doppler Color Flow") depending on scan mode
<b>2D/LA/Ao</b> Alias: LA/Ao	(17985-3, LN, "Left Atrium to Aortic Root Ratio")	(G-0373, SRT, "Image Mode") = (G-03A2, SRT, "2D mode") or (R-409E2, SRT, "Doppler Color Flow") depending on scan mode

<p>2D/LA Area Alias: LA Area</p>	<p>(G-A166, SRT, "Area")</p>	<p>(G-0373, SRT, "Image Mode") = (G-03A2, SRT, "2D mode") or (R-409E2, SRT, "Doppler Color Flow") depending on scan mode</p>
<p>LALd(A4C) Alias: LALd A4C</p>	<p>(29467-8, LN, "Left Atrium Superior-Inferior Dimension, 4-chamber view")</p>	<p>(R-4089A, SRT, "Cardiac Cycle Point") = (F-32010, SRT, "Diastole")</p>
<p>LAAAd(A4C) Alias: LAAAd A4C</p>	<p>(17977-0, LN, "Left Atrium Area A4C view")</p>	<p>(R-4089A, SRT, "Cardiac Cycle Point") = (F-32010, SRT, "Diastole")</p>
<p>LAEDV(A-L A4C) Alias: LAEDV A-L A4C</p>	<p>(122407, DCM, "Left Atrial End Diastolic Volume")</p>	<p>(111031, DCM, "Image View") = (G-A19C, SRT, "Apical four chamber") (G-C036, SRT, "Measurement Method") = (125205, DCM, "Area-Length Single Plane")</p>
<p>LAESV(A-L A4C) Alias: LAESV A-L A4C</p>	<p>(G-0383, SRT, "Left Atrium Systolic Volume")</p>	<p>(111031, DCM, "Image View") = (G-A19C, SRT, "Apical four chamber") (G-C036, SRT, "Measurement Method") = (125205, DCM, "Area-Length Single Plane")</p>
<p>LAEDV(MOD A4C) Alias: LAEDV MOD A4C</p>	<p>(122407, DCM, "Left Atrial End Diastolic Volume")</p>	<p>(111031, DCM, "Image View") = (G-A19C, SRT, "Apical four chamber") (G-C036, SRT, "Measurement Method") = (125208, DCM, "Method of Disks, Single Plane")</p>
<p>LALs(A4C) Alias: LALs A4C</p>	<p>(29467-8, LN, "Left Atrium Superior-Inferior Dimension, 4-chamber view")</p>	<p>(R-4089A, SRT, "Cardiac Cycle Point") = (F-32020, SRT, "Systole")</p>
<p>LAAAs(A4C) Alias: LAAAs A4C</p>	<p>(17977-0, LN, "Left Atrium Area A4C view")</p>	<p>(R-4089A, SRT, "Cardiac Cycle Point") = (F-32020, SRT, "Systole")</p>
<p>LAESV(MOD A4C) Alias: LAESV MOD A4C</p>	<p>(G-0383, SRT, "Left Atrium Systolic Volume")</p>	<p>(111031, DCM, "Image View") = (G-A19C, SRT, "Apical four chamber") (G-C036, SRT, "Measurement Method") = (125208, DCM, "Method of Disks, Single Plane")</p>
<p>LAEDV(A-L A2C) Alias: LAEDV A-L A2C</p>	<p>(122407, DCM, "Left Atrial End Diastolic Volume")</p>	<p>(111031, DCM, "Image View") = (G-A19B, SRT, "Apical two chamber") (G-C036, SRT, "Measurement Method") = (125205, DCM, "Area-Length Single Plane")</p>



		Plane")
LAEDV(MOD A2C) Alias: LAEDV MOD A2C	(122407, DCM, "Left Atrial End Diastolic Volume")	(111031, DCM, "Image View") = (G-A19B, SRT, "Apical two chamber") (G-C036, SRT, "Measurement Method") = (125208, DCM, "Method of Disks, Single Plane")
LAESV(A-L A2C) Alias: LAESV A-L A2C	(G-0383, SRT, "Left Atrium Systolic Volume")	(111031, DCM, "Image View") = (G-A19B, SRT, "Apical two chamber") (G-C036, SRT, "Measurement Method") = (125205, DCM, "Area-Length Single Plane")
LAESV(MOD A2C) Alias: LAESV MOD A2C	(G-0383, SRT, "Left Atrium Systolic Volume")	(111031, DCM, "Image View") = (G-A19B, SRT, "Apical two chamber") (G-C036, SRT, "Measurement Method") = (125208, DCM, "Method of Disks, Single Plane")
MM/LA/Ao Alias: LA/Ao	(17985-3, LN, "Left Atrium to Aortic Root Ratio")	(G-0373, SRT, "Image Mode") = (G-0394, SRT, "M mode")
MM/LA Alias: LA Diam	(29469-4, LN, "Left Atrium Antero-posterior Systolic Dimension")	(G-0373, SRT, "Image Mode") = (G-0394, SRT, "M mode")
2D/LAEDV(A-L) Alias: LAEDV(A-L)	(122407, DCM, "Left Atrial End Diastolic Volume")	(G-0373, SRT, "Image Mode") = (G-03A2, SRT, "2D mode") or (R-409E2, SRT, "Doppler Color Flow") depending on scan mode (G-C036, SRT, "Measurement Method") = (125204, DCM, "Area-Length Biplane")
2D/LAEDVI(A-L) Alias: LAEDV Index (A-L)	(GEU-106-0027, 99GEMS, "Left Atrial End Diastolic Volume Index")	(G-0373, SRT, "Image Mode") = (G-03A2, SRT, "2D mode") or (R-409E2, SRT, "Doppler Color Flow") depending on scan mode (G-C036, SRT, "Measurement Method") = (125204, DCM, "Area-Length Biplane")
2D/LAESV(A-L) Alias: LAESV(A-L)	(G-0383, SRT, "Left Atrium Systolic Volume")	(G-0373, SRT, "Image Mode") = (G-03A2, SRT, "2D mode") or (R-409E2, SRT, "Doppler Color Flow") depending on scan mode (G-C036, SRT, "Measurement Method") = (125204, DCM, "Area-Length Biplane")
LAEDV(MOD BP)	(122407, DCM, "Left Atrial	(G-0373, SRT, "Image Mode") = (G-03A2,



Alias: LAEDV(MOD BP)	End Diastolic Volume")	SRT, "2D mode") or (R-409E2, SRT, "Doppler Color Flow") depending on scan mode (G-C036, SRT, "Measurement Method") = (125207, DCM, "Method of Disks, Biplane")
LAESV(MOD BP) Alias: LAESV(MOD BP)	(G-0383, SRT, "Left Atrium Systolic Volume")	(G-0373, SRT, "Image Mode") = (G-03A2, SRT, "2D mode") or (R-409E2, SRT, "Doppler Color Flow") depending on scan mode (G-C036, SRT, "Measurement Method") = (125207, DCM, "Method of Disks, Biplane")

Section Right Atrium

GEU Parameter ID (and corresponding alias)	Base Measurement Concept Name	Concept or Acquisition Context Modifier
2D/RA Alias: RA Diam	(M-02550, SRT, "Diameter")	(G-0373, SRT, "Image Mode") = (G-03A2, SRT, "2D mode") or (R-409E2, SRT, "Doppler Color Flow") depending on scan mode
2D/RAD Major Alias: RA Major	(G-A193, SRT, "Major Axis")	(G-0373, SRT, "Image Mode") = (G-03A2, SRT, "2D mode") or (R-409E2, SRT, "Doppler Color Flow") depending on scan mode
2D/RAD Minor Alias: RA Minor	(G-A194, SRT, "Minor Axis")	(G-0373, SRT, "Image Mode") = (G-03A2, SRT, "2D mode") or (R-409E2, SRT, "Doppler Color Flow") depending on scan mode
RAAs(A4C) Alias: RAAs	(17988-7, LN, "Right Atrium Systolic Area")	
RAP Alias: RAP	(18070-3, LN, "Right Atrium Systolic Pressure")	

Section Aortic Valve

GEU Parameter ID (and	Base Measurement Concept	Concept or Acquisition Context Modifier
-----------------------	--------------------------	---

corresponding alias)	Name	
2D/AVA/AV Diam Alias: AV Diam	(G-038F, SRT, "Cardiovascular Orifice Diameter")	(G-C048, SRT, "Direction of Flow") = (R-42047, SRT, "Antegrade Flow") (G-0373, SRT, "Image Mode") = (G-03A2, SRT, "2D mode") or (R-409E2, SRT, "Doppler Color Flow") depending on scan mode
AV Dec Time Alias: AV Dec Time	(20217-6, LN, "Deceleration Time")	(G-C048, SRT, "Direction of Flow") = (R-42047, SRT, "Antegrade Flow")
AV Dec Slope Alias: AV Dec Slope	(20216-8, LN, "Deceleration Slope")	(G-C048, SRT, "Direction of Flow") = (R-42047, SRT, "Antegrade Flow")
PISA/AR/RF Alias: AR RF	(G-0390, SRT, "Regurgitant Fraction")	(G-C036, SRT, "Measurement Method") = (125216, DCM, "Proximal Isovelocity Surface Area")
MM/AV Diam Alias: AV Diam	(G-038F, SRT, "Cardiovascular Orifice Diameter")	(G-C048, SRT, "Direction of Flow") = (R-42047, SRT, "Antegrade Flow") (G-0373, SRT, "Image Mode") = (G-0394, SRT, "M mode")
2D/AV Diam Alias: AV Diam	(G-038F, SRT, "Cardiovascular Orifice Diameter")	(G-C048, SRT, "Direction of Flow") = (R-42047, SRT, "Antegrade Flow") (G-0373, SRT, "Image Mode") = (G-03A2, SRT, "2D mode") or (R-409E2, SRT, "Doppler Color Flow") depending on scan mode
2D/AV Cusp Alias: AV Cusp	(17996-0, LN, "Aortic Valve Cusp Separation")	(G-0373, SRT, "Image Mode") = (G-03A2, SRT, "2D mode") or (R-409E2, SRT, "Doppler Color Flow") depending on scan mode
2D/LAX/Trans AVA diastole Alias: Trans AVA (d)	(G-038E, SRT, "Cardiovascular Orifice Area")	(G-0373, SRT, "Image Mode") = (G-03A2, SRT, "2D mode") or (R-409E2, SRT, "Doppler Color Flow") depending on scan mode (R-4089A, SRT, "Cardiac Cycle Point") = (F-32010, SRT, "Diastole")
2D/LAX/Trans AVA systole Alias: Trans AVA (s)	(G-038E, SRT, "Cardiovascular Orifice Area")	(G-0373, SRT, "Image Mode") = (G-03A2, SRT, "2D mode") or (R-409E2, SRT, "Doppler Color Flow") depending on scan mode (R-4089A, SRT, "Cardiac Cycle Point") =

		(F-32020, SRT, "Systole")
2D/SAX/Trans AVA diastole Alias: Trans AVA (d)	(G-038E, SRT, "Cardiovascular Orifice Area")	(G-0373, SRT, "Image Mode") = (G-03A2, SRT, "2D mode") or (R-409E2, SRT, "Doppler Color Flow") depending on scan mode (R-4089A, SRT, "Cardiac Cycle Point") = (F-32010, SRT, "Diastole")
2D/SAX/Trans AVA systole Alias: Trans AVA (s)	(G-038E, SRT, "Cardiovascular Orifice Area")	(G-0373, SRT, "Image Mode") = (G-03A2, SRT, "2D mode") or (R-409E2, SRT, "Doppler Color Flow") depending on scan mode (R-4089A, SRT, "Cardiac Cycle Point") = (F-32020, SRT, "Systole")
2D/AVA Planimetry Alias: AVA Planimetry	(G-038E, SRT, "Cardiovascular Orifice Area")	(G-C048, SRT, "Direction of Flow") = (R-42047, SRT, "Antegrade Flow") (G-0373, SRT, "Image Mode") = (G-03A2, SRT, "2D mode") or (R-409E2, SRT, "Doppler Color Flow") depending on scan mode (G-C036, SRT, "Measurement Method") = (125220, DCM, "Planimetry")
2D/AV Area Alias: AV Area	(G-038E, SRT, "Cardiovascular Orifice Area")	(G-C048, SRT, "Direction of Flow") = (R-42047, SRT, "Antegrade Flow") (G-0373, SRT, "Image Mode") = (G-03A2, SRT, "2D mode") or (R-409E2, SRT, "Doppler Color Flow") depending on scan mode
MM/AV Cusp Alias: AV Cusp	(17996-0, LN, "Aortic Valve Cusp Separation")	(G-0373, SRT, "Image Mode") = (G-0394, SRT, "M mode")
AV Vmax Alias: AV Vmax	(11726-7, LN, "Peak Velocity")	(G-C048, SRT, "Direction of Flow") = (R-42047, SRT, "Antegrade Flow")
AV Vmax P Alias: AV Vmax	(11726-7, LN, "Peak Velocity")	(G-C048, SRT, "Direction of Flow") = (R-42047, SRT, "Antegrade Flow")
AV maxPG Alias: AV maxPG	(20247-3, LN, "Peak Gradient")	(G-C048, SRT, "Direction of Flow") = (R-42047, SRT, "Antegrade Flow")
AV Vmean	(20352-1, LN, "Mean	(G-C048, SRT, "Direction of Flow") = (R-

Alias: AV Vmean	Velocity")	42047, SRT, "Antegrade Flow")
AV meanPG Alias: AV meanPG	(20256-4, LN, "Mean Gradient")	(G-C048, SRT, "Direction of Flow") = (R-42047, SRT, "Antegrade Flow")
AV Acc Time Alias: AV AccT	(20168-1, LN, "Acceleration Time")	(G-C048, SRT, "Direction of Flow") = (R-42047, SRT, "Antegrade Flow")
AV VTI Alias: AV VTI	(20354-7, LN, "Velocity Time Integral")	(G-C048, SRT, "Direction of Flow") = (R-42047, SRT, "Antegrade Flow")
AVA (VTI) Alias: AVA (VTI)	(G-038E, SRT, "Cardiovascular Orifice Area")	(G-C048, SRT, "Direction of Flow") = (R-42047, SRT, "Antegrade Flow") (G-C036, SRT, "Measurement Method") = (125215, DCM, "Continuity Equation by Velocity Time Integral")
AVA (Vmax) Alias: AVA Vmax	(G-038E, SRT, "Cardiovascular Orifice Area")	(G-C048, SRT, "Direction of Flow") = (R-42047, SRT, "Antegrade Flow") (G-C036, SRT, "Measurement Method") = (125214, DCM, "Continuity Equation by Peak Velocity")
AVA (Vmax)2 Alias: AVA Vmax, Pt	(G-038E, SRT, "Cardiovascular Orifice Area")	(G-C048, SRT, "Direction of Flow") = (R-42047, SRT, "Antegrade Flow") (G-C036, SRT, "Measurement Method") = (125214, DCM, "Continuity Equation by Peak Velocity")
AVA (Vmax)P Alias: AVA Vmax, Pt	(G-038E, SRT, "Cardiovascular Orifice Area")	(G-C048, SRT, "Direction of Flow") = (R-42047, SRT, "Antegrade Flow") (G-C036, SRT, "Measurement Method") = (125214, DCM, "Continuity Equation by Peak Velocity")
AVA (Vmax)P2 Alias: AVA Vmax	(G-038E, SRT, "Cardiovascular Orifice Area")	(G-C048, SRT, "Direction of Flow") = (R-42047, SRT, "Antegrade Flow") (G-C036, SRT, "Measurement Method") = (125214, DCM, "Continuity Equation by Peak Velocity")
AV SV Alias: AV SV	(F-32120, SRT, "Stroke Volume")	(G-C0E3, SRT, "Finding Site") = (T-42000, SRT, "Aorta")

<b>AV HR</b> Alias: HR	(8867-4, LN, "Heart rate")	
<b>AV SI</b> Alias: AV SI	(F-00078, SRT, "Stroke Index")	(G-C0E3, SRT, "Finding Site") = (T-42000, SRT, "Aorta")
<b>AV CO</b> Alias: AV CO	(F-32100, SRT, "Cardiac Output")	(G-C0E3, SRT, "Finding Site") = (T-42000, SRT, "Aorta")
<b>AV CI</b> Alias: AV CI	(F-32110, SRT, "Cardiac Index")	(G-C0E3, SRT, "Finding Site") = (T-42000, SRT, "Aorta")
<b>AV Acc Slope</b> Alias: AV Acc Slope	(20167-3, LN, "Acceleration Slope")	(G-C048, SRT, "Direction of Flow") = (R-42047, SRT, "Antegrade Flow")
<b>AVET</b> Alias: AVET	(18041-4, LN, "Aortic Valve Ejection Time")	
<b>AV Acc Time/ET Ratio</b> Alias: AV Acc Time/ET	(G-0382, SRT, "Ratio of Aortic Valve Acceleration Time to Ejection Time")	
<b>AR PHT</b> Alias: AR PHT	(20280-4, LN, "Pressure Half-Time")	(G-C048, SRT, "Direction of Flow") = (R-42E61, SRT, "Regurgitant Flow")
<b>AR Dec Time</b> Alias: AR Dec Time	(20217-6, LN, "Deceleration Time")	(G-C048, SRT, "Direction of Flow") = (R-42E61, SRT, "Regurgitant Flow")
<b>AR Dec Slope</b> Alias: AR Dec Slope	(20216-8, LN, "Deceleration Slope")	(G-C048, SRT, "Direction of Flow") = (R-42E61, SRT, "Regurgitant Flow")
<b>AR Vmax</b> Alias: AR Vmax	(11726-7, LN, "Peak Velocity")	(G-C048, SRT, "Direction of Flow") = (R-42E61, SRT, "Regurgitant Flow")
<b>AR maxPG</b> Alias: AR maxPG	(20247-3, LN, "Peak Gradient")	(G-C048, SRT, "Direction of Flow") = (R-42E61, SRT, "Regurgitant Flow")

<p><b>ARend Vmax</b> Alias: ARend Vmax</p>	<p>(11726-7, LN, "Peak Velocity")</p>	<p>(G-C048, SRT, "Direction of Flow") = (R-42E61, SRT, "Regurgitant Flow") (R-4089A, SRT, "Cardiac Cycle Point") = (109022, DCM, "End Diastole")</p>
<p><b>ARend maxPG</b> Alias: ARend PG</p>	<p>(20247-3, LN, "Peak Gradient")</p>	<p>(G-C048, SRT, "Direction of Flow") = (R-42E61, SRT, "Regurgitant Flow") (R-4089A, SRT, "Cardiac Cycle Point") = (109022, DCM, "End Diastole")</p>
<p><b>AR Vmean</b> Alias: AR Vmean</p>	<p>(20352-1, LN, "Mean Velocity")</p>	<p>(G-C048, SRT, "Direction of Flow") = (R-42E61, SRT, "Regurgitant Flow")</p>
<p><b>AR meanPG</b> Alias: AR meanPG</p>	<p>(20256-4, LN, "Mean Gradient")</p>	<p>(G-C048, SRT, "Direction of Flow") = (R-42E61, SRT, "Regurgitant Flow")</p>
<p><b>AR VTI</b> Alias: AR VTI</p>	<p>(20354-7, LN, "Velocity Time Integral")</p>	<p>(G-C048, SRT, "Direction of Flow") = (R-42E61, SRT, "Regurgitant Flow")</p>
<p><b>PISA/AR/Flow</b> Alias: AR Flow</p>	<p>(34141-2, LN, "Peak Instantaneous Flow Rate")</p>	<p>(G-C048, SRT, "Direction of Flow") = (R-42E61, SRT, "Regurgitant Flow") (G-C036, SRT, "Measurement Method") = (125216, DCM, "Proximal Isovelocity Surface Area")</p>
<p><b>PISA/AR/Radius</b> Alias: AR Rad</p>	<p>(GEU-106-0004, 99GEMS, "Flow Radius")</p>	<p>(G-C048, SRT, "Direction of Flow") = (R-42E61, SRT, "Regurgitant Flow") (G-C036, SRT, "Measurement Method") = (125216, DCM, "Proximal Isovelocity Surface Area")</p>
<p><b>PISA/AR/Velocity</b> Alias: AR Als.Vel</p>	<p>(GEU-106-0005, 99GEMS, "Alias Velocity")</p>	<p>(G-C048, SRT, "Direction of Flow") = (R-42E61, SRT, "Regurgitant Flow") (G-C036, SRT, "Measurement Method") = (125216, DCM, "Proximal Isovelocity Surface Area")</p>
<p><b>PISA/AR/Vmax</b> Alias: AR Vmax</p>	<p>(11726-7, LN, "Peak Velocity")</p>	<p>(G-C048, SRT, "Direction of Flow") = (R-42E61, SRT, "Regurgitant Flow") (G-C036, SRT, "Measurement Method") = (125216, DCM, "Proximal Isovelocity Surface Area")</p>
<p><b>PISA/AR/VTI</b> Alias: AR VTI</p>	<p>(20354-7, LN, "Velocity Time Integral")</p>	<p>(G-C048, SRT, "Direction of Flow") = (R-42E61, SRT, "Regurgitant Flow") (G-C036, SRT, "Measurement Method") = (125216, DCM, "Proximal Isovelocity Surface Area")</p>

		Surface Area")
<b>PISA/AR/ERO</b> Alias: AR ERO	(G-038E, SRT, "Cardiovascular Orifice Area")	(G-C048, SRT, "Direction of Flow") = (R-42E61, SRT, "Regurgitant Flow") (G-C036, SRT, "Measurement Method") = (125216, DCM, "Proximal Isovelocity Surface Area")
<b>PISA/AR/RV</b> Alias: AR RV	(33878-0, LN, "Volume Flow")	(G-C048, SRT, "Direction of Flow") = (R-42E61, SRT, "Regurgitant Flow") (G-C036, SRT, "Measurement Method") = (125216, DCM, "Proximal Isovelocity Surface Area")

Section Mitral Valve

GEU Parameter ID (and corresponding alias)	Base Measurement Concept Name	Concept or Acquisition Context Modifier
<b>MV Reg Frac</b> Alias: MV Reg Frac	(G-0390, SRT, "Regurgitant Fraction")	
<b>MR Acc Slope</b> Alias: MR Acc Slope	(20167-3, LN, "Acceleration Slope")	(G-C048, SRT, "Direction of Flow") = (R-42E61, SRT, "Regurgitant Flow")
<b>MR dp/dt</b> Alias: MR dp/dt	(18035-6, LN, "Mitral Regurgitation dP/dt derived from Mitral Reg. velocity")	
<b>PISA/MR/RF</b> Alias: MR RF	(G-0390, SRT, "Regurgitant Fraction")	(G-C036, SRT, "Measurement Method") = (125216, DCM, "Proximal Isovelocity Surface Area")
<b>2D/MV Annulus Diam</b> Alias: MV Ann Diam	(G-038F, SRT, "Cardiovascular Orifice Diameter")	(G-C0E3, SRT, "Finding Site") = (T-35313, SRT, "Mitral Annulus") (G-C048, SRT, "Direction of Flow") = (R-42047, SRT, "Antegrade Flow") (G-0373, SRT, "Image Mode") = (G-03A2, SRT, "2D mode") or (R-409E2, SRT, "Doppler Color Flow") depending on scan mode
<b>2D/SAX/MVA</b> Alias: MVA Planimetry	(G-038E, SRT, "Cardiovascular Orifice Area")	(G-C048, SRT, "Direction of Flow") = (R-42047, SRT, "Antegrade Flow") (G-0373, SRT, "Image Mode") = (G-

		03A2, SRT, "2D mode") or (R-409E2, SRT, "Doppler Color Flow") depending on scan mode (111031, DCM, "Image View") = (G-0397, SRT, "Parasternal short axis")
2D/MVA Planimetry Alias: MVA Planimetry	(G-038E, SRT, "Cardiovascular Orifice Area")	(G-C048, SRT, "Direction of Flow") = (R-42047, SRT, "Antegrade Flow") (G-0373, SRT, "Image Mode") = (G-03A2, SRT, "2D mode") or (R-409E2, SRT, "Doppler Color Flow") depending on scan mode (G-C036, SRT, "Measurement Method") = (125220, DCM, "Planimetry")
2D/MV Area Alias: MV Area	(G-038E, SRT, "Cardiovascular Orifice Area")	(G-C048, SRT, "Direction of Flow") = (R-42047, SRT, "Antegrade Flow") (G-0373, SRT, "Image Mode") = (G-03A2, SRT, "2D mode") or (R-409E2, SRT, "Doppler Color Flow") depending on scan mode
MM/EPSS Alias: EPSS	(18036-4, LN, "Mitral Valve EPSS, E wave")	(G-0373, SRT, "Image Mode") = (G-0394, SRT, "M mode")
MM/MV E-F Slope Alias: E-F Slope	(18040-6, LN, "Mitral Valve E-F Slope by M-Mode")	
MM/MV E/A Ratio Alias: E/A Ratio	(18038-0, LN, "Mitral Valve E to A Ratio")	(G-0373, SRT, "Image Mode") = (G-0394, SRT, "M mode")
MV Acc Time Alias: MV AccT	(20168-1, LN, "Acceleration Time")	(G-C048, SRT, "Direction of Flow") = (R-42047, SRT, "Antegrade Flow")
MV Acc Slope Alias: MV Acc Slope	(20167-3, LN, "Acceleration Slope")	(G-C048, SRT, "Direction of Flow") = (R-42047, SRT, "Antegrade Flow")
MV A Dur Alias: MV A Dur	(G-0385, SRT, "Mitral Valve A-Wave Duration")	
MV E Velocity Alias: MV E Vel	(18037-2, LN, "Mitral Valve E-Wave Peak Velocity")	



<b>MV E VTI</b> Alias: MV E VTI	(20354-7, LN, "Velocity Time Integral")	(R-4089A, SRT, "Cardiac Cycle Point") = (R-40B1B, SRT, "Early Diastole")
<b>MV A Velocity</b> Alias: MV A Vel	(17978-8, LN, "Mitral Valve A-Wave Peak Velocity")	
<b>MV A VTI</b> Alias: MV A VTI	(20354-7, LN, "Velocity Time Integral")	(R-4089A, SRT, "Cardiac Cycle Point") = (F-32030, SRT, "Atrial Systole")
<b>MV Dec Time</b> Alias: MV DecT	(20217-6, LN, "Deceleration Time")	(G-C048, SRT, "Direction of Flow") = (R-42047, SRT, "Antegrade Flow")
<b>MV PHT</b> Alias: MV PHT	(20280-4, LN, "Pressure Half-Time")	(G-C048, SRT, "Direction of Flow") = (R-42047, SRT, "Antegrade Flow")
<b>MV Dec Slope</b> Alias: MV Dec Slope	(20216-8, LN, "Deceleration Slope")	(G-C048, SRT, "Direction of Flow") = (R-42047, SRT, "Antegrade Flow")
<b>MVA (PHT)</b> Alias: MVA By PHT	(G-038E, SRT, "Cardiovascular Orifice Area")	(G-C048, SRT, "Direction of Flow") = (R-42047, SRT, "Antegrade Flow") (G-C036, SRT, "Measurement Method") = (125210, DCM, "Area by Pressure Half-Time")
<b>MVA (VTI)</b> Alias: MVA (VTI)	(G-038E, SRT, "Cardiovascular Orifice Area")	(G-C048, SRT, "Direction of Flow") = (R-42047, SRT, "Antegrade Flow") (G-C036, SRT, "Measurement Method") = (125215, DCM, "Continuity Equation by Velocity Time Integral")
<b>MV meanPG</b> Alias: MV meanPG	(20256-4, LN, "Mean Gradient")	(G-C048, SRT, "Direction of Flow") = (R-42047, SRT, "Antegrade Flow")
<b>MV Vmax</b> Alias: MV Vmax	(11726-7, LN, "Peak Velocity")	(G-C048, SRT, "Direction of Flow") = (R-42047, SRT, "Antegrade Flow")
<b>MV Vmean</b> Alias: MV Vmean	(20352-1, LN, "Mean Velocity")	(G-C048, SRT, "Direction of Flow") = (R-42047, SRT, "Antegrade Flow")
<b>MV maxPG</b>	(20247-3, LN, "Peak	(G-C048, SRT, "Direction of Flow") = (R-

Alias: MV maxPG	Gradient")	42047, SRT, "Antegrade Flow")
MV VTI Alias: MV VTI	(20354-7, LN, "Velocity Time Integral")	(G-C048, SRT, "Direction of Flow") = (R-42047, SRT, "Antegrade Flow")
MV HR Alias: HR	(8867-4, LN, "Heart rate")	
MV SV Alias: MV SV	(F-32120, SRT, "Stroke Volume")	(G-C0E3, SRT, "Finding Site") = (T-35300, SRT, "Mitral Valve")
MV SI Alias: MV SI	(F-00078, SRT, "Stroke Index")	(G-C0E3, SRT, "Finding Site") = (T-35300, SRT, "Mitral Valve")
MV CO Alias: MV CO	(F-32100, SRT, "Cardiac Output")	(G-C0E3, SRT, "Finding Site") = (T-35300, SRT, "Mitral Valve")
MV CI Alias: MV CI	(F-32110, SRT, "Cardiac Index")	(G-C0E3, SRT, "Finding Site") = (T-35300, SRT, "Mitral Valve")
MV E/A Ratio Alias: MV E/A Ratio	(18038-0, LN, "Mitral Valve E to A Ratio")	
MV Acc Time/MV Dec Time Alias: MV AccT/DecT	(G-0386, SRT, "Mitral Valve AT/DT Ratio")	
MR Vmax Alias: MR Vmax	(11726-7, LN, "Peak Velocity")	(G-C048, SRT, "Direction of Flow") = (R-42E61, SRT, "Regurgitant Flow")
MR meanPG Alias: MR meanPG	(20256-4, LN, "Mean Gradient")	(G-C048, SRT, "Direction of Flow") = (R-42E61, SRT, "Regurgitant Flow")
MR Vmean Alias: MR Vmean	(20352-1, LN, "Mean Velocity")	(G-C048, SRT, "Direction of Flow") = (R-42E61, SRT, "Regurgitant Flow")
MR maxPG	(20247-3, LN, "Peak	(G-C048, SRT, "Direction of Flow") = (R-

Alias: MR maxPG	Gradient")	42E61, SRT, "Regurgitant Flow")
MR VTI Alias: MR VTI	(20354-7, LN, "Velocity Time Integral")	(G-C048, SRT, "Direction of Flow") = (R-42E61, SRT, "Regurgitant Flow")
MCO Alias: MCO	(G-0387, SRT, "Mitral Valve Closure to Opening Time")	
PISA/MR/Flow Alias: MR Flow	(34141-2, LN, "Peak Instantaneous Flow Rate")	(G-C048, SRT, "Direction of Flow") = (R-42E61, SRT, "Regurgitant Flow") (G-C036, SRT, "Measurement Method") = (125216, DCM, "Proximal Isovelocity Surface Area")
PISA/MR/Radius Alias: MR Rad	(GEU-106-0004, 99GEMS, "Flow Radius")	(G-C048, SRT, "Direction of Flow") = (R-42E61, SRT, "Regurgitant Flow") (G-C036, SRT, "Measurement Method") = (125216, DCM, "Proximal Isovelocity Surface Area")
PISA/MR/Velocity Alias: MR Als.Vel	(GEU-106-0005, 99GEMS, "Alias Velocity")	(G-C048, SRT, "Direction of Flow") = (R-42E61, SRT, "Regurgitant Flow") (G-C036, SRT, "Measurement Method") = (125216, DCM, "Proximal Isovelocity Surface Area")
PISA/MR/Vmax Alias: MR Vmax	(11726-7, LN, "Peak Velocity")	(G-C048, SRT, "Direction of Flow") = (R-42E61, SRT, "Regurgitant Flow") (G-C036, SRT, "Measurement Method") = (125216, DCM, "Proximal Isovelocity Surface Area")
PISA/MR/VTI Alias: MR VTI	(20354-7, LN, "Velocity Time Integral")	(G-C048, SRT, "Direction of Flow") = (R-42E61, SRT, "Regurgitant Flow") (G-C036, SRT, "Measurement Method") = (125216, DCM, "Proximal Isovelocity Surface Area")
PISA/MR/ERO Alias: MR ERO	(G-038E, SRT, "Cardiovascular Orifice Area")	(G-C048, SRT, "Direction of Flow") = (R-42E61, SRT, "Regurgitant Flow") (G-C036, SRT, "Measurement Method") = (125216, DCM, "Proximal Isovelocity Surface Area")
PISA/MR/RV	(33878-0, LN, "Volume Flow")	(G-C048, SRT, "Direction of Flow") = (R-42E61, SRT, "Regurgitant Flow") (G-C036, SRT, "Measurement Method")

Alias: MR RV		= (125216, DCM, "Proximal Isovelocity Surface Area")
MV Eprime Velocity Alias: E'	(59133-9, LN, "Peak Tissue Velocity")	(G-C0E3, SRT, "Finding Site") = (T-35313, SRT, "Mitral Annulus") (R-4089A, SRT, "Cardiac Cycle Point") = (R-40B1B, SRT, "Early Diastole")
MV E/Eprime Ratio/Calc Alias: E/E'	(59111-5, LN, "E Velocity to Annulus E Velocity Ratio")	

Section Pulmonic Valve

GEU Parameter ID (and corresponding alias)	Base Measurement Concept Name	Concept or Acquisition Context Modifier
2D/PV Annulus Diam Alias: PV Ann Diam	(G-038F, SRT, "Cardiovascular Orifice Diameter")	(G-C048, SRT, "Direction of Flow") = (R-42047, SRT, "Antegrade Flow") (G-0373, SRT, "Image Mode") = (G-03A2, SRT, "2D mode") or (R-409E2, SRT, "Doppler Color Flow") depending on scan mode
2D/PV Area Alias: PV Area	(G-038E, SRT, "Cardiovascular Orifice Area")	(G-C048, SRT, "Direction of Flow") = (R-42047, SRT, "Antegrade Flow") (G-0373, SRT, "Image Mode") = (G-03A2, SRT, "2D mode") or (R-409E2, SRT, "Doppler Color Flow") depending on scan mode
MM/Q-to-PV close Alias: Q-to-PV close	(20295-2, LN, "Time from Q wave to Pulmonic Valve Closes")	(G-0373, SRT, "Image Mode") = (G-0394, SRT, "M mode")
PV Vmax Alias: PV Vmax	(11726-7, LN, "Peak Velocity")	(G-C048, SRT, "Direction of Flow") = (R-42047, SRT, "Antegrade Flow")
PV Vmax P Alias: PV Vmax	(11726-7, LN, "Peak Velocity")	(G-C048, SRT, "Direction of Flow") = (R-42047, SRT, "Antegrade Flow")
PV maxPG Alias: PV maxPG	(20247-3, LN, "Peak Gradient")	(G-C048, SRT, "Direction of Flow") = (R-42047, SRT, "Antegrade Flow")

<b>PV Vmean</b> Alias: PV Vmean	(20352-1, LN, "Mean Velocity")	(G-C048, SRT, "Direction of Flow") = (R-42047, SRT, "Antegrade Flow")
<b>PV meanPG</b> Alias: PV meanPG	(20256-4, LN, "Mean Gradient")	(G-C048, SRT, "Direction of Flow") = (R-42047, SRT, "Antegrade Flow")
<b>PV Acc Time</b> Alias: PV AccT	(20168-1, LN, "Acceleration Time")	(G-C048, SRT, "Direction of Flow") = (R-42047, SRT, "Antegrade Flow")
<b>PV VTI</b> Alias: PV VTI	(20354-7, LN, "Velocity Time Integral")	(G-C048, SRT, "Direction of Flow") = (R-42047, SRT, "Antegrade Flow")
<b>PVA (VTI)</b> Alias: PVA (VTI)	(G-038E, SRT, "Cardiovascular Orifice Area")	(G-C048, SRT, "Direction of Flow") = (R-42047, SRT, "Antegrade Flow") (G-C036, SRT, "Measurement Method") = (125215, DCM, "Continuity Equation by Velocity Time Integral")
<b>PVA (Vmax)</b> Alias: PVA (Vmax)	(G-038E, SRT, "Cardiovascular Orifice Area")	(G-C048, SRT, "Direction of Flow") = (R-42047, SRT, "Antegrade Flow") (G-C036, SRT, "Measurement Method") = (125214, DCM, "Continuity Equation by Peak Velocity")
<b>PVA (Vmax)P</b> Alias: PVA (Vmax)	(G-038E, SRT, "Cardiovascular Orifice Area")	(G-C048, SRT, "Direction of Flow") = (R-42047, SRT, "Antegrade Flow") (G-C036, SRT, "Measurement Method") = (125214, DCM, "Continuity Equation by Peak Velocity")
<b>PV HR</b> Alias: HR	(8867-4, LN, "Heart rate")	
<b>PV Acc Slope</b> Alias: PV Acc Slope	(20167-3, LN, "Acceleration Slope")	(G-C048, SRT, "Direction of Flow") = (R-42047, SRT, "Antegrade Flow")
<b>PVET</b> Alias: PVET	(18042-2, LN, "Pulmonic Valve Ejection Time")	
<b>SD/Q-to-PV close</b>	(20295-2, LN, "Time from Q wave to Pulmonic Valve")	(G-0373, SRT, "Image Mode") = (R-409E4, SRT, "Doppler Pulsed")

Alias: Q-to-PV close	Closes"))	
PV Acc Time/ET Ratio Alias: PV AccT/ET	(G-0388, SRT, "Ratio of Pulmonic Valve Acceleration Time to Ejection Time")	
PR PHT Alias: PR PHT	(20280-4, LN, "Pressure Half-Time")	(G-C048, SRT, "Direction of Flow") = (R-42E61, SRT, "Regurgitant Flow")
PR Dec Time Alias: PR DecT	(20217-6, LN, "Deceleration Time")	(G-C048, SRT, "Direction of Flow") = (R-42E61, SRT, "Regurgitant Flow")
PR Dec Slope Alias: PR Dec Slope	(20216-8, LN, "Deceleration Slope")	(G-C048, SRT, "Direction of Flow") = (R-42E61, SRT, "Regurgitant Flow")
PR Vmax Alias: PR Vmax	(11726-7, LN, "Peak Velocity")	(G-C048, SRT, "Direction of Flow") = (R-42E61, SRT, "Regurgitant Flow")
PR maxPG Alias: PR maxPG	(20247-3, LN, "Peak Gradient")	(G-C048, SRT, "Direction of Flow") = (R-42E61, SRT, "Regurgitant Flow")
PR Vmean Alias: PR Vmean	(20352-1, LN, "Mean Velocity")	(G-C048, SRT, "Direction of Flow") = (R-42E61, SRT, "Regurgitant Flow")
PR meanPG Alias: PR meanPG	(20256-4, LN, "Mean Gradient")	(G-C048, SRT, "Direction of Flow") = (R-42E61, SRT, "Regurgitant Flow")
PR VTI Alias: PR VTI	(20354-7, LN, "Velocity Time Integral")	(G-C048, SRT, "Direction of Flow") = (R-42E61, SRT, "Regurgitant Flow")
PRend Vmax Alias: PRend Vmax	(11726-7, LN, "Peak Velocity")	(G-C048, SRT, "Direction of Flow") = (R-42E61, SRT, "Regurgitant Flow") (R-4089A, SRT, "Cardiac Cycle Point") = (109022, DCM, "End Diastole")
PRend maxPG Alias: PRend PG	(20247-3, LN, "Peak Gradient")	(G-C048, SRT, "Direction of Flow") = (R-42E61, SRT, "Regurgitant Flow") (R-4089A, SRT, "Cardiac Cycle Point") = (109022, DCM, "End Diastole")
PISA/PR/Flow	(34141-2, LN, "Peak	(G-C048, SRT, "Direction of Flow") = (R-

Alias: PR Flow	Instantaneous Flow Rate")	42E61, SRT, "Regurgitant Flow") (G-C036, SRT, "Measurement Method") = (125216, DCM, "Proximal Isovelocity Surface Area")
PISA/PR/Radius Alias: PR Rad	(GEU-106-0004, 99GEMS, "Flow Radius")	(G-C048, SRT, "Direction of Flow") = (R-42E61, SRT, "Regurgitant Flow") (G-C036, SRT, "Measurement Method") = (125216, DCM, "Proximal Isovelocity Surface Area")
PISA/PR/Velocity Alias: PR Als. Vel	(GEU-106-0005, 99GEMS, "Alias Velocity")	(G-C048, SRT, "Direction of Flow") = (R-42E61, SRT, "Regurgitant Flow") (G-C036, SRT, "Measurement Method") = (125216, DCM, "Proximal Isovelocity Surface Area")
PISA/PR/Vmax Alias: PR Vmax	(11726-7, LN, "Peak Velocity")	(G-C048, SRT, "Direction of Flow") = (R-42E61, SRT, "Regurgitant Flow") (G-C036, SRT, "Measurement Method") = (125216, DCM, "Proximal Isovelocity Surface Area")
PISA/PR/VTI Alias: PR VTI	(20354-7, LN, "Velocity Time Integral")	(G-C048, SRT, "Direction of Flow") = (R-42E61, SRT, "Regurgitant Flow") (G-C036, SRT, "Measurement Method") = (125216, DCM, "Proximal Isovelocity Surface Area")
PISA/PR/ERO Alias: PR ERO	(G-038E, SRT, "Cardiovascular Orifice Area")	(G-C048, SRT, "Direction of Flow") = (R-42E61, SRT, "Regurgitant Flow") (G-C036, SRT, "Measurement Method") = (125216, DCM, "Proximal Isovelocity Surface Area")
PISA/PR/RV Alias: PR RV	(33878-0, LN, "Volume Flow")	(G-C048, SRT, "Direction of Flow") = (R-42E61, SRT, "Regurgitant Flow") (G-C036, SRT, "Measurement Method") = (125216, DCM, "Proximal Isovelocity Surface Area")

**Section Tricuspid Valve**

GEU Parameter ID (and corresponding alias)	Base Measurement Concept Name	Concept or Acquisition Context Modifier
2D/TVA Planimetry	(G-038E, SRT, "Cardiovascular Orifice	(G-C048, SRT, "Direction of Flow") = (R-42047, SRT, "Antegrade Flow")

Alias: TVA Planimetry	Area")	(G-0373, SRT, "Image Mode") = (G-03A2, SRT, "2D mode") or (R-409E2, SRT, "Doppler Color Flow") depending on scan mode (G-C036, SRT, "Measurement Method") = (125220, DCM, "Planimetry")
2D/TV Annulus Diam Alias: TV Ann Diam	(G-038F, SRT, "Cardiovascular Orifice Diameter")	(G-C0E3, SRT, "Finding Site") = (T-35111, SRT, "Tricuspid Annulus") (G-C048, SRT, "Direction of Flow") = (R-42047, SRT, "Antegrade Flow") (G-0373, SRT, "Image Mode") = (G-03A2, SRT, "2D mode") or (R-409E2, SRT, "Doppler Color Flow") depending on scan mode
2D/TV Area Alias: TV Area	(G-038E, SRT, "Cardiovascular Orifice Area")	(G-C048, SRT, "Direction of Flow") = (R-42047, SRT, "Antegrade Flow") (G-0373, SRT, "Image Mode") = (G-03A2, SRT, "2D mode") or (R-409E2, SRT, "Doppler Color Flow") depending on scan mode
MM/Q-to-TV open Alias: Q-to-TV open	(20296-0, LN, "Time from Q wave to Tricuspid Valve Opens")	(G-0373, SRT, "Image Mode") = (G-0394, SRT, "M mode")
TV Acc Time Alias: TV AccT	(20168-1, LN, "Acceleration Time")	(G-C048, SRT, "Direction of Flow") = (R-42047, SRT, "Antegrade Flow")
TV Acc Slope Alias: TV Acc Slope	(20167-3, LN, "Acceleration Slope")	(G-C048, SRT, "Direction of Flow") = (R-42047, SRT, "Antegrade Flow")
TV E Velocity Alias: TV E Vel	(18031-5, LN, "Tricuspid Valve E Wave Peak Velocity")	
TV A Velocity Alias: TV A Vel	(18030-7, LN, "Tricuspid Valve A Wave Peak Velocity")	
TV Dec Time Alias: TV Dec Time	(20217-6, LN, "Deceleration Time")	(G-C048, SRT, "Direction of Flow") = (R-42047, SRT, "Antegrade Flow")
TV Dec Slope	(20216-8, LN, "Deceleration Slope")	(G-C048, SRT, "Direction of Flow") = (R-42047, SRT, "Antegrade Flow")



Alias: TV Dec Slope		
TV PHT Alias: TV PHT	(20280-4, LN, "Pressure Half-Time")	(G-C048, SRT, "Direction of Flow") = (R-42047, SRT, "Antegrade Flow")
TVA Alias: TVA	(G-038E, SRT, "Cardiovascular Orifice Area")	(G-C048, SRT, "Direction of Flow") = (R-42047, SRT, "Antegrade Flow")
TV meanPG Alias: TV meanPG	(20256-4, LN, "Mean Gradient")	(G-C048, SRT, "Direction of Flow") = (R-42047, SRT, "Antegrade Flow")
TV Vmax Alias: TV Vmax	(11726-7, LN, "Peak Velocity")	(G-C048, SRT, "Direction of Flow") = (R-42047, SRT, "Antegrade Flow")
TV Vmax P Alias: TV Vmax	(11726-7, LN, "Peak Velocity")	(G-C048, SRT, "Direction of Flow") = (R-42047, SRT, "Antegrade Flow")
TV Vmean Alias: TV Vmean	(20352-1, LN, "Mean Velocity")	(G-C048, SRT, "Direction of Flow") = (R-42047, SRT, "Antegrade Flow")
TV maxPG Alias: TV maxPG	(20247-3, LN, "Peak Gradient")	(G-C048, SRT, "Direction of Flow") = (R-42047, SRT, "Antegrade Flow")
TV VTI Alias: TV VTI	(20354-7, LN, "Velocity Time Integral")	(G-C048, SRT, "Direction of Flow") = (R-42047, SRT, "Antegrade Flow")
TVA (VTI) Alias: TVA (VTI)	(G-038E, SRT, "Cardiovascular Orifice Area")	(G-C048, SRT, "Direction of Flow") = (R-42047, SRT, "Antegrade Flow") (G-C036, SRT, "Measurement Method") = (125215, DCM, "Continuity Equation by Velocity Time Integral")
TVA (Vmax) Alias: TVA (Vmax)	(G-038E, SRT, "Cardiovascular Orifice Area")	(G-C048, SRT, "Direction of Flow") = (R-42047, SRT, "Antegrade Flow") (G-C036, SRT, "Measurement Method") = (125214, DCM, "Continuity Equation by Peak Velocity")
TVA (Vmax)P	(G-038E, SRT, "Cardiovascular Orifice Area")	(G-C048, SRT, "Direction of Flow") = (R-42047, SRT, "Antegrade Flow") (G-C036, SRT, "Measurement Method") =

Alias: TVA (Vmax)	Area")	(125214, DCM, "Continuity Equation by Peak Velocity")
TV HR Alias: HR	(8867-4, LN, "Heart rate")	
TV E/A Ratio Alias: TV E/A Ratio	(18039-8, LN, "Tricuspid Valve E to A Ratio")	
SD/Q-to-TV open Alias: Q-to-TV open	(20296-0, LN, "Time from Q wave to Tricuspid Valve Opens")	(G-0373, SRT, "Image Mode") = (R-409E4, SRT, "Doppler Pulsed")
TR meanPG Alias: TR meanPG	(20256-4, LN, "Mean Gradient")	(G-C048, SRT, "Direction of Flow") = (R-42E61, SRT, "Regurgitant Flow")
TR Vmax Alias: TR Vmax	(11726-7, LN, "Peak Velocity")	(G-C048, SRT, "Direction of Flow") = (R-42E61, SRT, "Regurgitant Flow")
TR Vmean Alias: TR Vmean	(20352-1, LN, "Mean Velocity")	(G-C048, SRT, "Direction of Flow") = (R-42E61, SRT, "Regurgitant Flow")
TR maxPG Alias: TR maxPG	(20247-3, LN, "Peak Gradient")	(G-C048, SRT, "Direction of Flow") = (R-42E61, SRT, "Regurgitant Flow")
TR VTI Alias: TR VTI	(20354-7, LN, "Velocity Time Integral")	(G-C048, SRT, "Direction of Flow") = (R-42E61, SRT, "Regurgitant Flow")
TCO Alias: TCO	(G-0389, SRT, "Tricuspid Valve Closure to Opening Time")	
PISA/TR/Flow Alias: TR Flow	(34141-2, LN, "Peak Instantaneous Flow Rate")	(G-C048, SRT, "Direction of Flow") = (R-42E61, SRT, "Regurgitant Flow") (G-C036, SRT, "Measurement Method") = (125216, DCM, "Proximal Isovelocity Surface Area")
PISA/TR/Radius Alias: TR Rad	(GEU-106-0004, 99GEMS, "Flow Radius")	(G-C048, SRT, "Direction of Flow") = (R-42E61, SRT, "Regurgitant Flow") (G-C036, SRT, "Measurement Method") = (125216, DCM, "Proximal Isovelocity

		Surface Area")
PISA/TR/Velocity Alias: TR Als.Vel	(GEU-106-0005, 99GEMS, "Alias Velocity")	(G-C048, SRT, "Direction of Flow") = (R-42E61, SRT, "Regurgitant Flow") (G-C036, SRT, "Measurement Method") = (125216, DCM, "Proximal Isovelocity Surface Area")
PISA/TR/Vmax Alias: TR Vmax	(11726-7, LN, "Peak Velocity")	(G-C048, SRT, "Direction of Flow") = (R-42E61, SRT, "Regurgitant Flow") (G-C036, SRT, "Measurement Method") = (125216, DCM, "Proximal Isovelocity Surface Area")
PISA/TR/VTI Alias: TR VTI	(20354-7, LN, "Velocity Time Integral")	(G-C048, SRT, "Direction of Flow") = (R-42E61, SRT, "Regurgitant Flow") (G-C036, SRT, "Measurement Method") = (125216, DCM, "Proximal Isovelocity Surface Area")
PISA/TR/ERO Alias: TR ERO	(G-038E, SRT, "Cardiovascular Orifice Area")	(G-C048, SRT, "Direction of Flow") = (R-42E61, SRT, "Regurgitant Flow") (G-C036, SRT, "Measurement Method") = (125216, DCM, "Proximal Isovelocity Surface Area")
PISA/TR/RV Alias: TR RV	(33878-0, LN, "Volume Flow")	(G-C048, SRT, "Direction of Flow") = (R-42E61, SRT, "Regurgitant Flow") (G-C036, SRT, "Measurement Method") = (125216, DCM, "Proximal Isovelocity Surface Area")

Section Aorta

GEU Parameter ID (and corresponding alias)	Base Measurement Concept Name	Concept or Acquisition Context Modifier
MM/LAAo/Ao Root Diam Alias: Ao Diam	(18015-8, LN, "Aortic Root Diameter")	(G-0373, SRT, "Image Mode") = (G-0394, SRT, "M mode")
2D/Ao Root Diam Alias: Ao Diam	(18015-8, LN, "Aortic Root Diameter")	(G-0373, SRT, "Image Mode") = (G-03A2, SRT, "2D mode") or (R-409E2, SRT, "Doppler Color Flow") depending on scan mode
2D/Ao Asc Diam	(18012-5, LN,	(G-0373, SRT, "Image Mode") = (G-03A2, SRT,

Alias: Ao asc	"Ascending Aortic Diameter")	"2D mode") or (R-409E2, SRT, "Doppler Color Flow") depending on scan mode
2D/Ao Arch Diam Alias: Ao Arch Diam	(18011-7, LN, "Aortic Arch Diameter")	(G-0373, SRT, "Image Mode") = (G-03A2, SRT, "2D mode") or (R-409E2, SRT, "Doppler Color Flow") depending on scan mode
2D/Ao Desc Diam Alias: Ao Desc Diam	(18013-3, LN, "Descending Aortic Diameter")	(G-0373, SRT, "Image Mode") = (G-03A2, SRT, "2D mode") or (R-409E2, SRT, "Doppler Color Flow") depending on scan mode
2D/Ao Isthmus Alias: Ao Isthmus	(18014-1, LN, "Aortic Isthmus Diameter")	(G-0373, SRT, "Image Mode") = (G-03A2, SRT, "2D mode") or (R-409E2, SRT, "Doppler Color Flow") depending on scan mode
MM/Ao Root Diam Alias: Ao Diam	(18015-8, LN, "Aortic Root Diameter")	(G-0373, SRT, "Image Mode") = (G-0394, SRT, "M mode")
Asc Ao Vmax Alias: AAo Vmax	(11726-7, LN, "Peak Velocity")	(G-C0E3, SRT, "Finding Site") = (T-42100, SRT, "Ascending Aorta")
Asc Ao maxPG Alias: AAo maxPG	(20247-3, LN, "Peak Gradient")	(G-C0E3, SRT, "Finding Site") = (T-42100, SRT, "Ascending Aorta")
Dsc Ao Vmax Alias: DAo Vmax	(11726-7, LN, "Peak Velocity")	(G-C0E3, SRT, "Finding Site") = (T-D0765, SRT, "Descending Aorta")
Dsc Ao maxPG Alias: DAo maxPG	(20247-3, LN, "Peak Gradient")	(G-C0E3, SRT, "Finding Site") = (T-D0765, SRT, "Descending Aorta")

Section Pulmonary Artery

GEU Parameter ID (and corresponding alias)	Base Measurement Concept Name	Concept or Acquisition Context Modifier
2D/MPA Alias: MPA	(18020-8, LN, "Main Pulmonary Artery Diameter")	(G-0373, SRT, "Image Mode") = (G-03A2, SRT, "2D mode") or (R-409E2, SRT, "Doppler Color Flow") depending on scan mode

<b>2D/RPA</b> Alias: RPA	(18021-6, LN, "Right Pulmonary Artery Diameter")	(G-0373, SRT, "Image Mode") = (G-03A2, SRT, "2D mode") or (R-409E2, SRT, "Doppler Color Flow") depending on scan mode
<b>2D/LPA</b> Alias: LPA	(18019-0, LN, "Left Pulmonary Artery Diameter")	(G-0373, SRT, "Image Mode") = (G-03A2, SRT, "2D mode") or (R-409E2, SRT, "Doppler Color Flow") depending on scan mode
<b>RPA Vmax</b> Alias: RPA Vmax	(11726-7, LN, "Peak Velocity")	(G-C0E3, SRT, "Finding Site") = (T-44200, SRT, "Right Pulmonary Artery")
<b>RPA maxPG</b> Alias: RPA maxPG	(20247-3, LN, "Peak Gradient")	(G-C0E3, SRT, "Finding Site") = (T-44200, SRT, "Right Pulmonary Artery")
<b>LPA Vmax</b> Alias: LPA Vmax	(GEU-106-0014, 99GEMS, "Left Pulmonary Artery Peak Velocity")	
<b>LPA maxPG</b> Alias: LPA maxPG	(GEU-106-0015, 99GEMS, "Left Pulmonary Artery Peak Gradient")	
<b>MPA Vmax</b> Alias: MPA Vmax	(G-038A, SRT, "Main Pulmonary Artery Peak Velocity")	

**Section Pulmonary Venous Structure**

<b>GEU Parameter ID (and corresponding alias)</b>	<b>Base Measurement Concept Name</b>	<b>Concept or Acquisition Context Modifier</b>
<b>P_Vein S</b> Alias: P Vein S	(29450-4, LN, "Pulmonary Vein Systolic Peak Velocity")	
<b>P_Vein D</b> Alias: P Vein D	(29451-2, LN, "Pulmonary Vein Diastolic Peak Velocity")	
<b>P_Vein A</b> Alias: P Vein A	(29453-8, LN, "Pulmonary Vein Atrial Contraction Reversal Peak Velocity")	

<b>P_Vein A Dur</b> Alias: P Vein A Dur	(G-038B, SRT, "Pulmonary Vein A-Wave Duration")	
<b>P_Vein S/D Ratio</b> Alias: P Vein S/D Ratio	(29452-0, LN, "Pulmonary Vein Systolic to Diastolic Ratio")	
<b>P_Vein S VTI</b> Alias: P Vein S VTI	(G-038C, SRT, "Pulmonary Vein S-Wave Velocity Time Integral")	
<b>P_Vein D VTI</b> Alias: P Vein D VTI	(G-038D, SRT, "Pulmonary Vein D-Wave Velocity Time Integral")	

**Section Vena Cava**

<b>GEU Parameter ID (and corresponding alias)</b>	<b>Base Measurement Concept Name</b>	<b>Concept or Acquisition Context Modifier</b>
<b>2D/IVC Diam Ins</b> Alias: IVC Diam Ins	(18006-7, LN, "Inferior Vena Cava Diameter")	(R-40899, SRT, "Respiratory Cycle Point") = (F-20010, SRT, "During Inspiration")
<b>2D/IVC Diam Exp</b> Alias: IVC Diam Exp	(18006-7, LN, "Inferior Vena Cava Diameter")	(R-40899, SRT, "Respiratory Cycle Point") = (F-20020, SRT, "During Expiration")
<b>2D/IVC</b> Alias: IVC	(18006-7, LN, "Inferior Vena Cava Diameter")	(G-0373, SRT, "Image Mode") = (G-03A2, SRT, "2D mode") or (R-409E2, SRT, "Doppler Color Flow") depending on scan mode

**Section Cardiac Shunt Study**

<b>GEU Parameter ID (and corresponding alias)</b>	<b>Base Measurement Concept Name</b>	<b>Concept or Acquisition Context Modifier</b>
<b>Qp/Qs</b> Alias: Qp/Qs	(29462-9, LN, "Pulmonary-to-Systemic Shunt Flow Ratio")	
<b>Systemic VTI</b>	(20354-7, LN, "Velocity Time	(G-C048, SRT, "Direction of Flow") = (F-

Alias: Systemic VTI	Integral")	32330, SRT, "Left to right cardiovascular shunt")
Pulmonic VTI Alias: Pulmonic VTI	(20354-7, LN, "Velocity Time Integral")	(G-C048, SRT, "Direction of Flow") = (F-32340, SRT, "Right to left cardiovascular shunt")

Section Congenital Anomaly of Cardiovascular System

GEU Parameter ID (and corresponding alias)	Base Measurement Concept Name	Concept or Acquisition Context Modifier
2D/ASD Diam Alias: ASD Diam	(G-038F, SRT, "Cardiovascular Orifice Diameter")	(G-C0E3, SRT, "Finding Site") = (D4-31220, SRT, "Atrial Septal Defect") (G-0373, SRT, "Image Mode") = (G-03A2, SRT, "2D mode") or (R-409E2, SRT, "Doppler Color Flow") depending on scan mode
2D/VSD Diam Alias: VSD Diam	(G-038F, SRT, "Cardiovascular Orifice Diameter")	(G-C0E3, SRT, "Finding Site") = (D4-31150, SRT, "Ventricular Septal Defect") (G-0373, SRT, "Image Mode") = (G-03A2, SRT, "2D mode") or (R-409E2, SRT, "Doppler Color Flow") depending on scan mode
VSD Vmax Alias: VSD Vmax	(11726-7, LN, "Peak Velocity")	(G-C0E3, SRT, "Finding Site") = (D4-31150, SRT, "Ventricular Septal Defect")
VSD maxPG Alias: VSD maxPG	(20247-3, LN, "Peak Gradient")	(G-C0E3, SRT, "Finding Site") = (D4-31150, SRT, "Ventricular Septal Defect")
ASD Vmax Alias: ASD Vmax	(11726-7, LN, "Peak Velocity")	(G-C0E3, SRT, "Finding Site") = (D4-31220, SRT, "Atrial Septal Defect")
ASD maxPG Alias: ASD maxPG	(20247-3, LN, "Peak Gradient")	(G-C0E3, SRT, "Finding Site") = (D4-31220, SRT, "Atrial Septal Defect")

Section Pericardial cavity

GEU Parameter ID (and	Base Measurement	Concept or Acquisition Context Modifier
-----------------------	------------------	---

corresponding alias)	Concept Name	
<p><b>2D/PEs</b> Alias: PEs</p>	<p>(121206, DCM, "Distance")</p>	<p>(G-C0E3, SRT, "Finding Site") = (D3-90008, SRT, "Pericardial effusion")                      (G-0373, SRT, "Image Mode") = (G-03A2, SRT, "2D mode") or (R-409E2, SRT, "Doppler Color Flow") depending on scan mode                      (R-4089A, SRT, "Cardiac Cycle Point") = (F-32020, SRT, "Systole")</p>
<p><b>2D/PEd</b> Alias: PEd</p>	<p>(121206, DCM, "Distance")</p>	<p>(G-C0E3, SRT, "Finding Site") = (D3-90008, SRT, "Pericardial effusion")                      (G-0373, SRT, "Image Mode") = (G-03A2, SRT, "2D mode") or (R-409E2, SRT, "Doppler Color Flow") depending on scan mode                      (R-4089A, SRT, "Cardiac Cycle Point") = (F-32010, SRT, "Diastole")</p>
<p><b>MM/PEd</b> Alias: PEd</p>	<p>(121206, DCM, "Distance")</p>	<p>(G-C0E3, SRT, "Finding Site") = (D3-90008, SRT, "Pericardial effusion")                      (G-0373, SRT, "Image Mode") = (G-0394, SRT, "M mode")                      (R-4089A, SRT, "Cardiac Cycle Point") = (F-32010, SRT, "Diastole")</p>



### 13. VASCULAR ULTRASOUND PROCEDURE REPORT

This section describes the contents of the Vascular Ultrasound Procedure Report (TID 5100) SR.

Note: If “Use older SR version” is enabled (see 2.6, 3.6 and 7) the corresponding section present in the DICOM Conformance Statement of the selected version should be used.

#### 13.1 USAGE AND EXTENSION OF TID 5100 VASCULAR ULTRASOUND REPORT

	NL	Relation with Parent	Value Type	Concept Name	VM	Req Type	Condition	Value Set Constraint
1			CONTAINER	EV (125100, DCM, “Vascular Ultrasound Procedure Report”)	1	M		
	>	HAS OBS CONTEXT	INCLUDE	DTID (1001) Observation Context	1	M		
	>	CONTAINS	INCLUDE	DTID (5101) Vascular Patient Characteristics	1	U		
	>	CONTAINS	INCLUDE	DTID (5102) Vascular Procedure Summary Section	1	U		
	>	CONTAINS	INCLUDE	DTID (5103) Vascular Ultrasound Section	1-n	U		

#### 13.2 TID 5101 VASCULAR PATIENT CHARACTERISTICS

	NL	Relation with Parent	Value Type	Concept Name	VM	Req Type	Condition	Value Set Constraint
1			CONTAINER	EV (121118, DCM, “Patient Characteristics”)	1	M		
	>	CONTAINS	NUM	EV (121033, DCM, “Subject Age”)	1	U		Units = DCID (7456) Units of Measure for Age
	>	CONTAINS	CODE	EV (121032, DCM, “Subject Sex”)	1	U		DCID (7455) Sex
	>	CONTAINS	NUM	EV (8867-4, LN, “Heart Rate”)	1	U		

	>	CONTAINS	NUM	EV (F-008EC, SRT, "Systolic Blood Pressure")	1	U		
	>	CONTAINS	NUM	EV (F-008ED, SRT, "Diastolic Blood Pressure")	1	U		

**13.3 TID 5102 VASCULAR PROCEDURE SUMMARY SECTION**

	NL	Relation with Parent	Value Type	Concept Name	VM	Req Type	Condition	Value Set Constraint
1			CONTAINER	DT (121111, DCM, "Summary")	1	M		
	>	CONTAINS	TEXT	EV (121106, DCM, "Comment")	1	M		

**13.4 TID 5103 VASCULAR ULTRASOUND SECTION (EXTENDED)**

	NL	Relation with Parent	Value Type	Concept Name	VM	Req Type	Condition	Value Set Constraint
			CONTAINER	DT (121070, DCM, "Findings")	1	M		
	>	HAS CONCEPT MOD	CODE	EV (G-C0E3, SRT, "Finding Site")	1	M		See 13.6. GEU Applications and Extensions - \$SectionScope
	>	HAS CONCEPT MOD	CODE	EV (G-C171, SRT, "Laterality")	1	U		See 13.9 GE Ultrasound Sidedness and Vessel Location
	>	HAS CONCEPT MOD	CODE	EV (G-0373, SRT, "Image Mode")	1	M		See 13.8 GE Ultrasound modes.
	>	CONTAINS	INCLUDE	DTID (5104) Vascular Measurement Group	1-n	M		See 13.5 TID 5104 Vascular Ultrasound Measurement Group
	>	CONTAINS	INCLUDE	DTID (300) Measurement	1-n	U		\$Measurement = \$AnatomyRatio

\* This template is extended with the Image Mode row.

**13.5 TID 5104 VASCULAR ULTRASOUND MEASUREMENT GROUP**

	NL	Relation with Parent	Value Type	Concept Name	VM	Req Type	Condition	Value Set Constraint
1			CONTAINER	\$Anatomy GEU Parameters	1	M		See 13.6 GEU Applications and Extensions – Anatomy GEU Parameter
	>	HAS CONCEPT MOD	CODE	EV (G-A1F8, SRT, "Topographical Modifier")	1	U		See 13.9 GE Ultrasound Sidedness and Vessel Location
	>	CONTAINS	INCLUDE	DTID (300) Measurement	1-n	U		\$Measurement = See 13.10 Vascular Base Measurement \$Derivation = DCID (3626) Measurement

								Type
--	--	--	--	--	--	--	--	------

**13.6 GEU APPLICATIONS AND EXTENSIONS**

Section Scope	Section Laterality	Anatomy	Anatomy Ratio	GEU Parameters																			
(T-40501, SRT, "Blood Vessel of Head")	(G-A101, SRT, "Left") for Left,  (G-A100, SRT, "Right") for Right.  or  (G-A103, SRT, "Unilateral")	DCID 12105 Intracranial Cerebral Vessels  or  DCID 12106 Intracranial Cerebral Vessels (Unilateral)		<p style="text-align: center;"><b>BASE MEASUREMENT CONCEPT NAME</b></p> <table border="1" style="width: 100%; border-collapse: collapse;"> <thead> <tr> <th data-bbox="948 632 1146 730" style="text-align: center;">Anatomy GEU parameter</th> <th data-bbox="1146 632 1510 730" style="text-align: center;">Code and Description</th> </tr> </thead> <tbody> <tr> <td data-bbox="948 730 1146 829" style="text-align: center;">ICA</td> <td data-bbox="1146 730 1510 829">(T-45300, SRT, "Internal Carotid Artery")</td> </tr> <tr> <td data-bbox="948 829 1146 928" style="text-align: center;">MCA</td> <td data-bbox="1146 829 1510 928">G (T-45600, SRT, "Middle Cerebral Artery")</td> </tr> <tr> <td data-bbox="948 928 1146 1026" style="text-align: center;">ACA</td> <td data-bbox="1146 928 1510 1026">(T-45540, SRT, "Anterior Cerebral Artery")</td> </tr> <tr> <td data-bbox="948 1026 1146 1125" style="text-align: center;">PCA</td> <td data-bbox="1146 1026 1510 1125">(T-45900, SRT, "Posterior Cerebral Artery")</td> </tr> <tr> <td data-bbox="948 1125 1146 1224" style="text-align: center;">PComA</td> <td data-bbox="1146 1125 1510 1224">(T-45320, SRT, "Posterior Communicating Artery")</td> </tr> <tr> <td data-bbox="948 1224 1146 1323" style="text-align: center;">AComA</td> <td data-bbox="1146 1224 1510 1323">(T-45530, SRT, "Anterior Communicating Artery")</td> </tr> <tr> <td data-bbox="948 1323 1146 1421" style="text-align: center;">VERT</td> <td data-bbox="1146 1323 1510 1421">(T-45700, SRT, "Vertebral Artery")</td> </tr> <tr> <td data-bbox="948 1421 1146 1476" style="text-align: center;">BA</td> <td data-bbox="1146 1421 1510 1476">(T-45800, SRT, "Basilar Artery")</td> </tr> </tbody> </table>		Anatomy GEU parameter	Code and Description	ICA	(T-45300, SRT, "Internal Carotid Artery")	MCA	G (T-45600, SRT, "Middle Cerebral Artery")	ACA	(T-45540, SRT, "Anterior Cerebral Artery")	PCA	(T-45900, SRT, "Posterior Cerebral Artery")	PComA	(T-45320, SRT, "Posterior Communicating Artery")	AComA	(T-45530, SRT, "Anterior Communicating Artery")	VERT	(T-45700, SRT, "Vertebral Artery")	BA	(T-45800, SRT, "Basilar Artery")
				Anatomy GEU parameter	Code and Description																		
				ICA	(T-45300, SRT, "Internal Carotid Artery")																		
				MCA	G (T-45600, SRT, "Middle Cerebral Artery")																		
				ACA	(T-45540, SRT, "Anterior Cerebral Artery")																		
				PCA	(T-45900, SRT, "Posterior Cerebral Artery")																		
				PComA	(T-45320, SRT, "Posterior Communicating Artery")																		
				AComA	(T-45530, SRT, "Anterior Communicating Artery")																		
				VERT	(T-45700, SRT, "Vertebral Artery")																		
				BA	(T-45800, SRT, "Basilar Artery")																		
<b>TABLE 13.6.1 TCD Study Folder Code Maps</b>																							

(T-45005, SRT, "Artery of neck)	(G-A101, SRT, "Left") for Left, or (G-A100, SRT, "Right") for Right.	DCID 12104 Extracranial Arteries	DCID 12123 Carotid Ratios	<b>Anatomy GEU parameter</b>	<b>Code and Description</b>
				VERT	(T-45700, SRT, "Vertebral Artery")
				CCA	(T-45100, SRT, "Common Carotid Artery")
				ICA	(T-45300, SRT, "Internal Carotid Artery")
				BULB	(T-45170, SRT, "Carotid Bulb")
				ECA	(T-45200, SRT, "External Carotid Artery")
				SUBC	(T-46100, SRT, "Subclavian Artery")
				BIF	(SRT, T-45160, "Carotid Bifurcation")
<b>TABLE 13.6.2 CAROTID STUDY FOLDER CODE MAPS</b>					

(T-47040, SRT, "Artery of Lower Extremity") or (G-A101, SRT, "Left") for Left, or (G-A100, SRT, "Right") for Right. or (G-A103, SRT, "Unilateral")	DCID 12109 Lower Extremity Arteries or DCID 12112 Abdominal Arteries (unilateral)	<b>Anatomy GEU parameter</b>	<b>Code and Description</b>
		ComIliac	(T-46710, SRT, "Common Iliac Artery")
		ExtIliac (EIA)	(T-46910, SRT, "External Iliac Artery")
		ComFemoral (CFA)	(T-47400, SRT, "Common Femoral Artery")
		SupFemoral (SFA)	(T-47403, SRT, "Superficial Femoral Artery")
		Popliteal (Pop A)	(T-47500, SRT, "Popliteal Artery")
		AntTibial (ATA)	(T-47700, SRT, "Anterior Tibial Artery")
		PostTibial (PTA)	T-47600, SRT, "Posterior Tibial Artery")
		Peroneal (Peron A)	(T-47630, SRT, "Peroneal Artery")
		DorsPedis (DPA)	(T-47741, SRT, "Dorsalis Pedis Artery")
		DeepFemoral (DFA)	(T-47440, SRT, "Profunda Femoris Artery")
		Profunda (Pro)	(T-47440, SRT, "Profunda Femoris Artery")
		Aorta	(T-4200, SRT, "Aorta")
		TABLE 13.6.3 <b>LEA</b> STUDY FOLDER CODE MAPS	

(T-49403, SRT, “Vein of Lower Extremity”)	(G-A101, SRT, “Left”) for Left, or (G-A100, SRT, “Right”) for Right. Or (G-A103, SRT, “Unilateral”)	DCID 12110 Lower Extremity of Veins or DCID 12114 Abdominal Veins (unilateral)	<b>Anatomy GEU parameter</b>	<b>Code and Description</b>
			Popliteal	(T-49640, SRT, “Popliteal Vein”)
			LSaphenous	(T-49550, SRT, “Lesser Saphenous Vein”)
			AntTibial	(T-49630, SRT, “Anterior Tibial Vein”)
			PostTibial	(T-49620, SRT, “Posterior Tibial Vein”)
			Peroneal	(T-49650, SRT, “Peroneal Vein”)
			Profunda	(T-49660, SRT, “Profunda Femoris Vein”)
			ExtIliac	(T-48930, SRT, “External Iliac Vein”)
			ComFemoral	(G-035B, SRT, “Common Femoral Vein”)
			ComIliac	(T-48920, SRT, “Common Iliac Vein”)
			Great saphenous	(T-49530, SRT, “Great Saphenous Vein”)
			Femoral	(G-035B, SRT, “Femoral Vein”)
			IVC	(T-48710, SRT, “Inferior Vena Cava”)
			DeepFemoral	(T-49660, SRT, “Profunda Femoris Vein”)
<b>TABLE 13.6.4 LEV STUDY FOLDER CODE MAPS</b>				



(T-47020, SRT, "Artery of Upper Extremity")	(G-A101, SRT, "Left") for Left, or (G-A100, SRT, "Right") for Right.	DCID (12107) Upper Extremity Arteries		<b>Anatomy GEU parameter</b>	<b>Code and Description</b>
				SUBC	(T-46100, SRT, "Subclavian artery")
				Axill	(T-47100, SRT, "Axillary artery")
				BrachialA	(T-47160, SRT, "Brachial artery")
				RadialA	(T-47300, SRT, "Radial artery")
				UlnarA	(T-47200, SRT, "Ulnar artery")
				Palmar	(T-47340, SRT, "Deep Palmar Arch of Radial Artery")
				Innominate	(T-46010, SRT, "Innominate Artery")
				TABLE 13.6.5 <b>UEA</b> STUDY FOLDER CODE MAPS	

(T-49103, SRT, "Vein of Upper Extremity")	(G-A101, SRT, "Left") for Left, or (G-A100, SRT, "Right") for Right.	DCID 12108 Upper Extremity Veins		<b>Anatomy GEU parameter</b>	<b>Code and Description</b>
				JugularV	(T-48170, SRT, "Internal Jugular vein")
				InnoV	(T-48620, SRT, "Innominate vein")
				SUBCV	(T-48330, SRT, "Subclavian vein")
				AxillV	(T-49110, SRT, "Axillary vein")
				CephV	(T-49240, SRT, "Cephalic vein")
				BasilV	(T-48052, SRT, "Basilic vein")
				BracV	(T-49350, SRT, "Brachial vein")
				McubV	(T-49250, SRT, "Median Cubital vein")
				RadialV	(T-49340, SRT, "Radial vein")
				UlnarV	(T-49330, SRT, "Ulnar vein")
				<b>TABLE 13.6.6 UEV STUDY FOLDER CODE MAPS</b>	

(T-71019, SRT, "Vascular Structure of Kidney")	(G-A101, SRT, "Left") for Left, or (G-A100, SRT, "Right") for Right.	DCID 12115 Renal Vessels	DCID 12124 Renal Ratios	<b>Anatomy GEU parameter</b>	<b>Code and Description</b>
				MRenalA	(T-46600, SRT, "Renal Artery")
				RenalV	(T-48740, SRT, "Renal Vein")
				SegmentalA	(T-46659, SRT, "Segmental Artery")
				InterlobarA	(T-4667D, SRT, "Interlobar Artery of Kidney")
				ArcurateA	(T-4668A, SRT, "Arcuate Artery of the Kidney")
				Aorta	(T-4200, SRT, "Aorta")
				<b>TABLE 13.6.7. RENAL STUDY FOLDER CODE MAPS</b>	

(T-46002, SRT, "Artery of Abdomen")  (G-A101, SRT, "Left") for Left  (G-A100, SRT, "Right") for Right  or  (G-A103, SRT, "Unilateral")	DCID 12111 or 12112 Abdominal Arteries (lateral or unilateral).  DCID 12113 or 12114 Abdominal Veins (lateral or unilateral)  or  DCID 12115 Renal Vessels	<b>Anatomy GEU parameter</b>	<b>Code and Description</b>
		Aorta	(T-42000, SRT, "Aorta")
		Celiac	(T-46400, SRT, "Celiac Axis")
		CHA	(T-46421, SRT, "Common Hepatic Artery")
		Splenic A	(T-46460, SRT, "Splenic Artery")
		SMA	(T-46510, SRT, "Superior Mesenteric Artery")
		IMA	(T-46520, SRT, "Inferior Mesenteric Artery")
		MRenalA	(T-46600, SRT, "Renal Artery")
		RenalV	(T-48740, SRT, "Renal Vein")
		SegmentalA	(T-46659, SRT, "Segmental Artery")
		InterlobarA	(T-4667D, SRT, "Interlobar Artery of Kidney")
		ArcurateA	(T-4668A, SRT, "Arcuate Artery of the Kidney")
		CIA	(T-46710, SRT, "Common Iliac Artery")
		PrHepatic	(T-46422, SRT, "Proper Hepatic Artery")
		GDA	(T-46440, SRT, Gastroduodenal Artery)
		IVC	(T-48710, SRT, "Inferior Vena Cava")
		Splenic V	(T-48890, SRT, Splenic Vein")
		Hepatic V	(T-48720, SRT, Hepatic Vein")
		MHV	(T-48726, SRT, Middle Hepatic Vein")
		MPV	(GEU-1004-65, 99GEMS, "Main Branch of Portal Vein")
		Portal V	(T-48810, SRT, "Portal Vein")
		SMV	(T-48840, SRT, "Superior Mesenteric Vein")
		TIPS	(G-036C, SRT, "Transjugular Intrahepatic Portosystemic Shunt")
		CIV	(T-48920, SRT, "Common Iliac Vein")

TABLE 13.6.8 ABDOMEN STUDY FOLDER CODE MAPS

**13.7 TID 300 MEASUREMENT**

	NL	Relation with Parent	Value Type	Concept Name	VM	Req Type	Condition	Value Set Constraint
1			NUM	\$Measurement	1	M		Units = \$Units
4	>	HAS CONCEPT MOD	CODE	EV(G-A1F8, SRT, "Topographical modifier")	1	U		See 13.9 GE Ultrasound Sidedness and Vessel Location
5	>	HAS CONCEPT MOD	CODE	EV(121401, DCM, "Derivation")	1	U		See 13.11 Derivation and Selection
6	>	HAS PROPERTIES	CODE	EV(121404, DCM, "Selection Status")	1	U		See 13.11 Derivation and Selection

**13.8 GE ULTRASOUND MODES**

<b>GE Ultrasound Modes</b>	<b>Code Value</b>
2D	(G-03A2, SRT, "2D mode")
CF	(R-409E2, SRT, "Doppler Color Flow")
PW	(R-409E4, SRT, "Doppler Pulsed")
MM	(G-0394, SRT, "M mode")
CW	(R-409E3, SRT, "Doppler Continuous Wave")

**13.9 GE ULTRASOUND SIDEDNESS AND VESSEL LOCATION**

<b>Side</b>	<b>Code Value</b>
Rt	(G-A100, SRT, "Right")
Lt	(G-A101, SRT, "Left")

<b>Vessel Location</b>	<b>Code Value</b>
Prox	(G-A118, SRT, "Proximal")

Mid	(G-A188, SRT, “Mid-longitudinal”)
Dist	(G-A119, SRT, “Distal”)

Note (\*) when there is no Sidedness or Locations, the SR nodes are not populated.

**13.10 SR MAPPING TABLE FOR VASCULAR BASE MEASUREMENT CONCEPT**

<b>GEU Measurement Parameter</b>	<b>Standard Measurement Concept Name</b>
PS	(11726-7, LN, “Peak Systolic Velocity”)
ED	(11653-3, LN, “End Diastolic Velocity”)
MD	(11665-7, LN, “Minimum Diastolic Velocity”)
Tamax	(11692-1, LN, “Time averaged peak velocity”)
PI	(12008-9, LN, “Pulsatility Index”)
RI	(12023-8, LN, “Resistivity Index”)
PV	(11726-7, LN, Peak Velocity)
SD Ratio	(12144-2, LN, “Systolic to Diastolic Velocity Ratio”)
DS Ratio	(122218, DCM, Diastolic/Systolic Velocity Ratio)
Accel	(20167-3, LN, “Acceleration Index”)
AT	(20168-1, LN, “Acceleration Time”)
TAMEAN	(20352-1, LN, “Time averaged mean velocity”)
VOLFLOW	(33878-0, LN, “Volume flow”)
ICACCA Ratio (PS)	(33868-1, LN, “ICA/CCA velocity ratio”)
HR (Heart Rate)	(8867-4, LN, Heart Rate)
AC	(GEU-1004-9, 99GEMS, “Angular Correction”)
RAR	(33869-9, LN, “Renal Artery/Aorta velocity ratio”)

**TABLE 13.10.1 PWD-MODE MEASUREMENTS**

<b>GEU Measurement Parameter</b>	<b>Standard Measurement Concept Name</b>
DiamStenD1/D2	(G-0364 , SRT, " Vessel Lumen Diameter")
AreaStenA1/A2	(G-0366, SRT, "Vessel Lumen Cross-Sectional Area")
StenosisD	(R-101BB, SRT, " Lumen Diameter Stenosis")
StenosisA	(R-101BA, SRT, "Lumen Area Stenosis")
IMT Ant Avg	(GEU-1005-20, 99GEMS, "IMT Anterior Average")
IMT Ant Max	(GEU-1005-21, 99GEMS, "IMT Anterior Max")
IMT Ant Min	(GEU-1005-22, 99GEMS, "IMT Anterior Min")
IMT Ant SD	(GEU-1005-23, 99GEMS, "IMT Anterior SD")
IMT Ant nMeas	(GEU-1005-24, 99GEMS, "IMT Anterior nMeas")
IMT Post Avg	(GEU-1005-26, 99GEMS, "IMT Posterior Average")
IMT Post Max	(GEU-1005-27, 99GEMS, "IMT Posterior Max")
IMT Post Min	(GEU-1005-28, 99GEMS, "IMT Posterior Min")
IMT Post SD	(GEU-1005-29, 99GEMS, "IMT Posterior SD")
IMT Post nMeas	(GEU-1005-30, 99GEMS, "IMT Posterior nMeas")

**TABLE 13.10.2 VASCULAR B-MODE MEASUREMENTS**

**13.11 DERIVATION AND SELECTION**

<b>GEU Name</b>	<b>Derivation</b>	<b>Selection</b>
Av	Mean	User chosen value
Mx	Maximum	User chosen value
Mn	Minimum	User chosen value
Lt	Most recent value chosen	User chosen value
*(decided by another parameter)	Best Value	User chosen value