



Technical Publications

**Direction DOC1585895
Revision 2**

LOGIQ E8 R2 DICOM CONFORMANCE STATEMENT

Copyright© 2014 by General Electric Co.

Do not duplicate



GE Healthcare



GE Healthcare

THIS PAGE LEFT INTENTIONALLY BLANK

CONFORMANCE STATEMENT OVERVIEW

LOGIQ E8 is an Ultrasound Scanner acting as an acquisition modality in a DICOM network. LOGIQ E8 Product is compliance to DICOM 3.0.

Table 0.1 provides an overview of the network services supported by LOGIQ E8.

Table 0.1 – NETWORK SERVICES

SOP Classes	User of Service (SCU)	Provider of Service (SCP)
Transfer		
Ultrasound Image Storage	Yes	Yes
Ultrasound Image Storage (Retired)	Yes	Yes
Ultrasound Multi-frame Image Storage	Yes	Yes
Ultrasound Multi-frame Image Storage (Retired)	Yes	Yes
Enhanced US Volume Storage	Yes	Yes
Secondary Capture Image Storage	Yes	Yes
Comprehensive SR	Yes	No
Key Object Selection Document	Yes	No
Verification SOP Class	Yes	Yes
CT Image Storage	Yes	Yes
MR Image Storage	Yes	Yes
Positron Emission Tomography Image Storage	Yes	Yes
Digital Mammography X-Ray Image Storage – For Presentation	Yes	Yes
Digital Mammography X-Ray Image Storage – For Processing	Yes	Yes
Query/Retrieve		
Study Root Query/Retrieve Information Model – FIND	Yes	No
Study Root Query/Retrieve Information Model – MOVE	Yes	No
Print Management		
Basic Grayscale Print Management Meta SOP Class	Yes	No
Basic Color Print Management Meta SOP Class	Yes	No
Basic Annotation Box	Yes	No
Printer SOP Class	Yes	No
Basic Film Session SOP Class	Yes	No
Basic Film Box SOP Class	Yes	No
Basic Grayscale Image Box SOP Class	Yes	No
Basic Color Image Box SOP Class	Yes	No
Workflow Management		
Storage Commitment Push Model SOP Class	Yes	No

DIR DOC1585895 REV 2

Modality Performed Procedure Step SOP Class	Yes	No
Modality Worklist Information Model – FIND SOP Class	Yes	No

Table 0.2 provides an overview of the Media Storage Application Profiles supported by LOGIQ E8.

Table 0.2 - MEDIA SERVICES

Media Storage Application Profile	Write Files (FSC or FSU)	Read Files (FSR)
Compact Disk - Recordable		
General Purpose CD-R	Yes	Yes
DVD		
General Purpose DVD Interchange with JPEG	Yes	Yes
General Purpose DVD Interchange with JPEG 2000	Yes	Yes
USB		
General Purpose USB Media Interchange with JPEG	Yes	Yes
General Purpose USB Media Interchange with JPEG 2000	Yes	Yes

TABLE OF CONTENTS

1.	INTRODUCTION	7
1.1	Overview	7
1.2	Overall DICOM Conformance Statement Document Structure	9
1.3	Intended Audience	10
1.4	Scope and Field of Application	10
1.5	Important Remarks	10
1.6	References	11
1.7	Definitions	11
1.8	Symbols and Abbreviations.....	13
2.	NETWORK CONFORMANCE STATEMENT.....	15
2.1	Introduction	15
2.2	Implementation Model	15
2.3	AE Specifications.....	17
2.4	COMMUNICATION PROFILES.....	40
3.	MEDIA STORAGE CONFORMANCE STATEMENT.....	43
3.4	AUGMENTED AND PRIVATE APPLICATION PROFILES.....	47
4.	ULTRASOUND IMAGE INFORMATION OBJECT IMPLEMENTATION.....	49
4.1	Introduction	49
4.2	LOGIQ E8 Mapping of DICOM Entities	49
4.3	IOD Module Table	49
4.4	Information Module Definitions	50
5.	ULTRASOUND MULTI-FRAME IMAGE INFORMATION OBJECT IMPLEMENTATION.....	62
5.1	Introduction	62
5.2	LOGIQ E8 Mapping of DICOM Entities	62

DIR DOC1585895 REV 2

5.3	IOD Module Table	62
5.4	Information Module Definitions	63
6.	ENHANCED US VOLUME INFORMATION OBJECT IMPLEMENTATION	65
6.1	Introduction	65
6.2	LOGIQ E8 Mapping of DICOM Entities	65
6.3	IOD Module Table	65
6.4	Information Module Definitions	66
7.	SECONDARY CAPTURE INFORMATION OBJECT IMPLEMENTATION	76
7.1	Introduction	76
7.2	LOGIQ E8 Mapping of DICOM Entities	76
7.3	IOD Module Table	76
7.4	Information Module Definitions	77
8.	COMPREHENSIVE STRUCTURED REPORT INFORMATION OBJECT IMPLEMENTATION.....	79
8.1	Introduction	79
8.2	LOGIQ E8 Mapping of DICOM Entities	79
8.3	IOD Module Table	79
8.4	Information Module Definitions	80
8.5	Standard Extended and Private Data Attributes	85
8.6	Standard Extended and Private Context Groups	85
8.7	Standard, Standard Extended and Private Templates.....	85
9.	KEY OBJECT SELECTION DOCUMENT INFORMATION OBJECT IMPLEMENTATION	87
9.1	Introduction	87
9.2	LOGIQ E8 Mapping of DICOM Entities	87
9.3	IOD Module Table	87
9.4	Information Module Definitions	88
9.5	Standard, Standard Extended and Private Templates.....	89

10. MODALITY WORKLIST INFORMATION MODEL DEFINITION	90
10.1 Introduction	90
10.2 Modality Worklist Information Model Description	90
10.3 Modality Worklist Information Model Entity-Relationship Model.....	90
10.4 Information Model Module Table	92
10.5 Information Model Keys	93
11. MODALITY PERFORMED PROCEDURE STEP IMPLEMENTATION	99
11.1 Introduction	99
11.2 MODALITY PERFORMED PROCEDURE STEP MODULE TABLE.....	99
11.3 MODALITY PERFORMED PROCEDURE STEP MODULE DEFINITIONS.....	100
11.4 SOP Common Module	100
11.5 Performed Procedure Step Relationship Module	100
11.6 Performed Procedure Step Information Module.....	102
11.7 Image Acquisition Results Module.....	102
12. STORAGE COMMITMENT PUSH MODEL IMPLEMENTATION	104
12.1 Introduction	104
12.2 Storage Commitment Push Model Sop Class Definition.....	104
13. BASIC DIRECTORY INFORMATION OBJECT IMPLEMENTATION	108
13.1 Introduction	108
13.2 Basic Directory Iod Implementation	108
13.3 Basic Directory Entity-Relationship Model.....	108
13.4 IOD Module Table	109
13.5 Information Module Definitions	110
13.6 PRIVATE DATA DICTIONARY	117
14. PRINT MANAGEMENT IMPLEMENTATION.....	119
14.1 INTRODUCTION.....	119
14.2 Basic Print Management Meta Sop Classes	119

DIR DOC1585895 REV 2

14.3	Print Management Sop Class Definitions	120
14.4	Print Management Iods	123
14.5	Information Module Definitions	124
15.	STUDY ROOT QUERY/RETRIEVE INFORMATION MODEL	131
15.1	Introduction	131
15.2	Study Root Information Model Description	131
15.3	Study Root Information Model Entity-Relationship Model	131
15.4	Information Model Keys	132
15.5	Private Data Dictionary	136
16.	DICOM SR TEMPLATES	137
16.1	Vascular Ultrasound Procedure Report	137
16.2	Echocardiography Procedure Report	153
16.3	OB-GYN Ultrasound Procedure Report.....	184
16.4	Breast Imaging Report	193
16.5	Soft tissue neck and head Imaging Report	199
16.6	Key Object Selection Document Template	208
16.7	GE Ultrasound M&A Report.....	209

1. INTRODUCTION

1.1 OVERVIEW

This DICOM Conformance Statement is divided into Sections as described below:

Section 1 (Introduction), which describes the overall structure, intent, and references for this Conformance Statement

Section 2 (Network Conformance Statement), which specifies the GEHC equipment compliance to the DICOM requirements for the implementation of Networking features.

Section 3 (Media Storage Conformance Statement), which specifies the GEHC equipment compliance to the DICOM requirements for the implementation of Media Storage features.

Section 4 (Ultrasound Image Information Object Implementation), which specifies the GEHC equipment compliance to DICOM requirements for the implementation of an Ultrasound Image Information Object.

Section 5 (Ultrasound Multi-Frame Image Information Object Implementation), which specifies the GEHC equipment compliance to DICOM requirements for the implementation of an Ultrasound Multi-Frame Image Information.

Section 6 (Enhanced US Volume Information Object Implementation), which specifies the GEHC equipment compliance to DICOM requirements for the implementation of an Enhanced US Volume Information.

Section 7 (Secondary Capture Object Implementation), which specifies the GEHC equipment compliance to DICOM requirements for the implementation of a Secondary Capture Information Object.

Section 8 (Comprehensive Structured Report Object Implementation), which specifies the GEHC equipment compliance to DICOM requirements for the implementation of a Comprehensive Structured Reporting Information Object.

Section 9 (Key Object Selection Document Implementation), which specifies the GEHC equipment compliance to DICOM requirements for the implementation of a Key Object Selection Document Object.

Section 10 (Modality Worklist Information Model), which specifies the GEHC equipment compliance to DICOM requirements for the implementation of the Modality Worklist service.

Section 11 (Modality Performed Procedure Step Implementation), which specifies the GEHC equipment compliance to DICOM requirements for the implementation of Modality Performed Procedure Step Service.

Section 12 (Storage Commitment Push Model SOP Implementation), which specifies the GEHC equipment compliance to DICOM requirements for the implementation of the Storage Commitment Push Model Service.

Section 13 (Basic Directory Information Object Implementation), which specifies the GEHC equipment compliance to DICOM requirements for the implementation of a Basic Directory Information Object.

Section 14 (Print Management), which specifies the GEHC equipment compliance to DICOM requirements for the implementation of Basic Print Meta SOP Classes (Gray and Color).

Section 15 (Study Root Query/Retrieve Information Model), which specifies the GEHC equipment compliance to DICOM requirements for the Study Root Query/Retrieve Information Model.

Section 16 (DICOM SR Templates), which specifies all LOGIQ E8 supported DICOM SR Templates.

1.2 OVERALL DICOM CONFORMANCE STATEMENT DOCUMENT STRUCTURE

The Documentation Structure of the GEHC DICOM Conformance Statements is shown in the Illustration below.

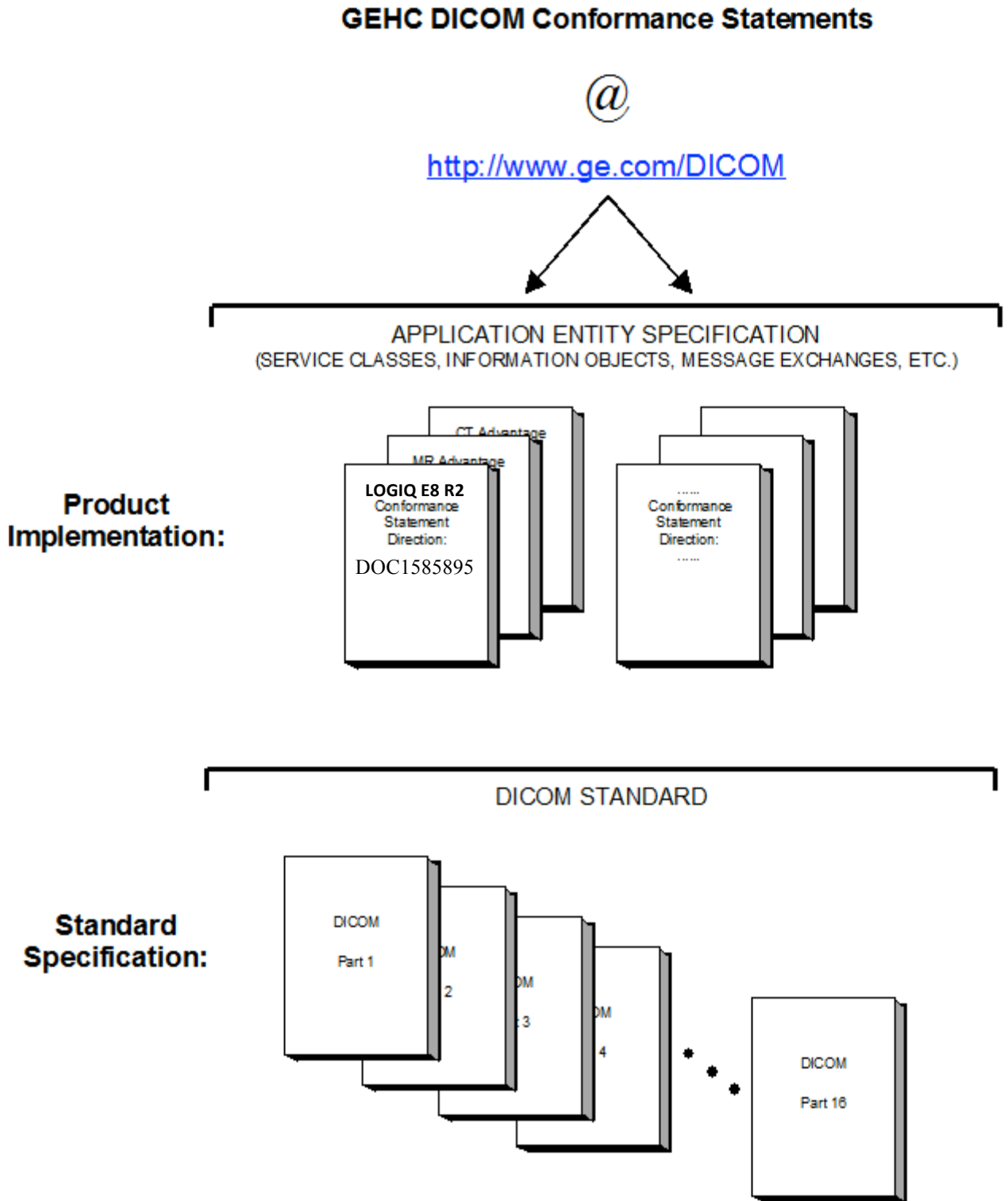

This document specifies the DICOM implementation. It is entitled:

LOGIQ E8 R2
Conformance Statement for DICOM
Direction DOC1585895

This DICOM Conformance Statement documents the DICOM Conformance Statement and Technical Specification required to interoperate with the GEHC network interface.

The GEHC Conformance Statement, contained in this document, also specifies the Lower Layer communications which it supports (e.g., TCP/IP). However, the Technical Specifications are defined in the DICOM Part 8 standard.

For more information regarding DICOM, copies of the Standard may be obtained on the Internet at <http://medical.nema.org>. Comments on the Standard may be addressed to:

DICOM Secretariat
NEMA
1300 N. 17th Street, Suite 1752
Rosslyn, VA 22209
USA
Phone: +1.703.841.3200

1.3 INTENDED AUDIENCE

The reader of this document is concerned with software design and/or system integration issues. It is assumed that the reader of this document is familiar with the DICOM Standard and with the terminology and concepts which are used in that Standard.

1.4 SCOPE AND FIELD OF APPLICATION

It is the intent of this document to provide an unambiguous specification for GEHC implementations. This specification, called a Conformance Statement, includes a DICOM Conformance Statement and is necessary to ensure proper processing and interpretation of GEHC medical data exchanged using DICOM. The GEHC Conformance Statements are available to the public.

The reader of this DICOM Conformance Statement should be aware that different GEHC devices are capable of using different Information Object Definitions. For example, a GEHC CT Scanner may send images using the CT Information Object, MR Information Object, Secondary Capture Object, etc.

Included in this DICOM Conformance Statement are the Module Definitions which define all data elements used by this GEHC implementation. If the user encounters unspecified private data elements while parsing a GEHC Data Set, the user is well advised to ignore those data elements (per the DICOM standard). Unspecified private data element information is subject to change without notice. If, however, the device is acting as a "full fidelity storage device", it should retain and re-transmit all of the private data elements which are sent by GEHC devices.

1.5 IMPORTANT REMARKS

The use of these DICOM Conformance Statements, in conjunction with the DICOM Standards, is intended to facilitate communication with GE imaging equipment. However, **by itself, it is not sufficient to ensure that inter-operation will be successful.** The user (or user's agent) needs to proceed with caution and address at least four issues:

Integration - The integration of any device into an overall system of interconnected devices goes beyond the scope of standards (DICOM v3.0), and of this introduction and associated DICOM Conformance Statements when interoperability with non-GE equipment is desired. The responsibility to analyze the applications requirements and to design a solution that

DIR DOC1585895 REV 2

integrates GE imaging equipment with non-GE systems is the **user's** responsibility and should not be underestimated. The **user** is strongly advised to ensure that such an integration analysis is correctly performed.

Validation - Testing the complete range of possible interactions between any GE device and non-GE devices, before the connection is declared operational, should not be overlooked. Therefore, the **user** should ensure that any non-GE provider accepts full responsibility for all validation required for their connection with GE devices. This includes the accuracy of the image data once it has crossed the interface between the GE imaging equipment and the non-GE device and the stability of the image data for the intended applications.

Such a validation is required before any clinical use (diagnosis and/or treatment) is performed. It applies when images acquired on GE imaging equipment are processed/displayed on a non-GE device, as well as when images acquired on non-GE equipment is processed/displayed on a GE console or workstation.

Future Evolution - GE understands that the DICOM Standard will evolve to meet the user's growing requirements. GE is actively involved in the development of the DICOM Standard. DICOM will incorporate new features and technologies and GE may follow the evolution of the Standard. The GEHC protocol is based on DICOM as specified in each DICOM Conformance Statement. Evolution of the Standard may require changes to devices which have implemented DICOM. **In addition, GE reserves the right to discontinue or make changes to the support of communications features (on its products) described by these DICOM Conformance Statements.** The **user** should ensure that any non-GE provider, which connects with GE devices, also plans for the future evolution of the DICOM Standard. Failure to do so will likely result in the loss of function and/or connectivity as the DICOM Standard changes and GE Products are enhanced to support these changes.

Interaction - It is the sole responsibility of the **non-GE provider** to ensure that communication with the interfaced equipment does not cause degradation of GE imaging equipment performance and/or function.

1.6 REFERENCES

NEMA PS3 Digital Imaging and Communications in Medicine (DICOM) Standard, available free at <http://medical.nema.org/>

1.7 DEFINITIONS

Informal definitions are provided for the following terms used in this Conformance Statement. The DICOM Standard is the authoritative source for formal definitions of these terms.

Abstract Syntax – the information agreed to be exchanged between applications, generally equivalent to a Service/Object Pair (SOP) Class. Examples: Verification SOP Class, Modality Worklist Information Model Find SOP Class, Computed Radiography Image Storage SOP Class.

Application Entity (AE) – an end point of a DICOM information exchange, including the DICOM network or media interface software; i.e., the software that sends or receives DICOM information objects or messages. A single device may have multiple Application Entities.

Application Entity Title – the externally known name of an *Application Entity*, used to identify a DICOM application to other DICOM applications on the network.

Application Context – the specification of the type of communication used between *Application Entities*. Example: DICOM network protocol.

Association – a network communication channel set up between *Application Entities*.

Attribute – a unit of information in an object definition; a data element identified by a *tag*. The information may be a complex data structure (Sequence), itself composed of lower level data elements. Examples: Patient ID (0010,0020), Accession Number (0008,0050), Photometric Interpretation (0028,0004), Procedure Code Sequence (0008,1032).

Information Object Definition (IOD) – the specified set of *Attributes* that comprise a type of data object; does not represent a specific instance of the data object, but rather a class of similar data objects that have the same properties. The *Attributes* may be specified as Mandatory (Type 1), Required but possibly unknown (Type 2), or Optional (Type 3), and there may be

GE Healthcare

DIR DOC1585895 REV 2

conditions associated with the use of an Attribute (Types 1C and 2C). Examples: MR Image IOD, CT Image IOD, Print Job IOD.

Joint Photographic Experts Group (JPEG) – a set of standardized image compression techniques, available for use by DICOM applications.

Media Application Profile – the specification of DICOM information objects and encoding exchanged on removable media (e.g., CDs)

Module – a set of *Attributes* within an *Information Object Definition* that are logically related to each other. Example: Patient Module includes Patient Name, Patient ID, Patient Birth Date, and Patient Sex.

Negotiation – first phase of *Association* establishment that allows *Application Entities* to agree on the types of data to be exchanged and how that data will be encoded.

Presentation Context – the set of DICOM network services used over an *Association*, as negotiated between *Application Entities*; includes *Abstract Syntaxes* and *Transfer Syntaxes*.

Protocol Data Unit (PDU) – a packet (piece) of a DICOM message sent across the network. Devices must specify the maximum size packet they can receive for DICOM messages.

Security Profile – a set of mechanisms, such as encryption, user authentication, or digital signatures, used by an *Application Entity* to ensure confidentiality, integrity, and/or availability of exchanged DICOM data

Service Class Provider (SCP) – role of an *Application Entity* that provides a DICOM network service; typically, a server that performs operations requested by another *Application Entity* (*Service Class User*). Examples: Picture Archiving and Communication System (image storage SCP, and image query/retrieve SCP), Radiology Information System (modality worklist SCP).

Service Class User (SCU) – role of an *Application Entity* that uses a DICOM network service; typically, a client. Examples: imaging modality (image storage SCU, and modality worklist SCU), imaging workstation (image query/retrieve SCU)

Service/Object Pair (SOP) Class – the specification of the network or media transfer (service) of a particular type of data (object); the fundamental unit of DICOM interoperability specification. Examples: Ultrasound Image Storage Service, Basic Grayscale Print Management.

Service/Object Pair (SOP) Instance – an information object; a specific occurrence of information exchanged in a *SOP Class*. Examples: a specific x-ray image.

Tag – a 32-bit identifier for a data element, represented as a pair of four digit hexadecimal numbers, the “group” and the “element”. If the “group” number is odd, the tag is for a private (manufacturer-specific) data element. Examples: (0010,0020) [Patient ID], (07FE,0010) [Pixel Data], (0019,0210) [private data element]

Transfer Syntax – the encoding used for exchange of DICOM information objects and messages. Examples: *JPEG* compressed (images), little endian explicit value representation.

Unique Identifier (UID) – a globally unique “dotted decimal” string that identifies a specific object or a class of objects; an ISO-8824 Object Identifier. Examples: Study Instance UID, SOP Class UID, SOP Instance UID.

Value Representation (VR) – the format type of an individual DICOM data element, such as text, an integer, a person’s name, or a code. DICOM information objects can be transmitted with either explicit identification of the type of each data element (Explicit VR), or without explicit identification (Implicit VR); with Implicit VR, the receiving application must use a DICOM data dictionary to look up the format of each data element.

GE Healthcare

DIR DOC1585895 REV 2

1.8 SYMBOLS AND ABBREVIATIONS

AE	Application Entity
AET	Application Entity Title
CD-R	Compact Disk Recordable
CT	Computed Tomography
DHCP	Dynamic Host Configuration Protocol
DICOM	Digital Imaging and Communications in Medicine
DNS	Domain Name System
FSC	File-Set Creator
FSU	File-Set Updater
FSR	File-Set Reader
HIS	Hospital Information System
HL7	Health Level 7 Standard
IHE	Integrating the Healthcare Enterprise
IOD	Information Object Definition
IPv4	Internet Protocol version 4
IPv6	Internet Protocol version 6
ISO	International Organization for Standards
JPEG	Joint Photographic Experts Group
LUT	Look-up Table
MPEG	Moving Picture Experts Group
MG	Mammography (X-ray)
MPPS	Modality Performed Procedure Step
MR	Magnetic Resonance Imaging
MWL	Modality Worklist
O	Optional (Key Attribute)
OP	Ophthalmic Photography
OSI	Open Systems Interconnection
PACS	Picture Archiving and Communication System

GE Healthcare

DIR DOC1585895 REV 2

PET Positron Emission Tomography

PDU Protocol Data Unit

R Required (Key Attribute)

RIS Radiology Information System

SC Secondary Capture

SCP Service Class Provider

SCU Service Class User

SOP Service-Object Pair

SPS Scheduled Procedure Step

SR Structured Reporting

TCP/IP Transmission Control Protocol/Internet Protocol

U Unique (Key Attribute)

UL Upper Layer

US Ultrasound

VR Value Representation

KOS Key Object Selection

2. NETWORK CONFORMANCE STATEMENT

2.1 INTRODUCTION

This section of the DICOM Conformance Statement specifies the LOGIQ E8 compliance to DICOM requirements for **Networking** features.

Sending and receiving Echo messages to and from DICOM Verification SCP and client.

Sending DICOM Images to remote DICOM Storage SCP.

Sending measurements as DICOM SR objects to remote DICOM Storage SCP.

Querying and retrieving DICOM Modality Worklist from a Worklist SCP.

Sending start and end of examination to a DICOM Modality Performed Procedure Step SCP.

Sending storage commitment requests (and receiving replies) to a DICOM Storage Commitment SCP.

Printing images to a DICOM Printer.

Querying and retrieving examinations from a DICOM Query/Retrieve SCP.

2.2 IMPLEMENTATION MODEL

2.2.1 Application Data Flow Diagram

The network application model for the LOGIQ E8 is shown in the following Illustration :

ILLUSTRATION 2-1
LOGIQ E8 NETWORK APPLICATION MODEL AND DATA FLOW DIAGRAM

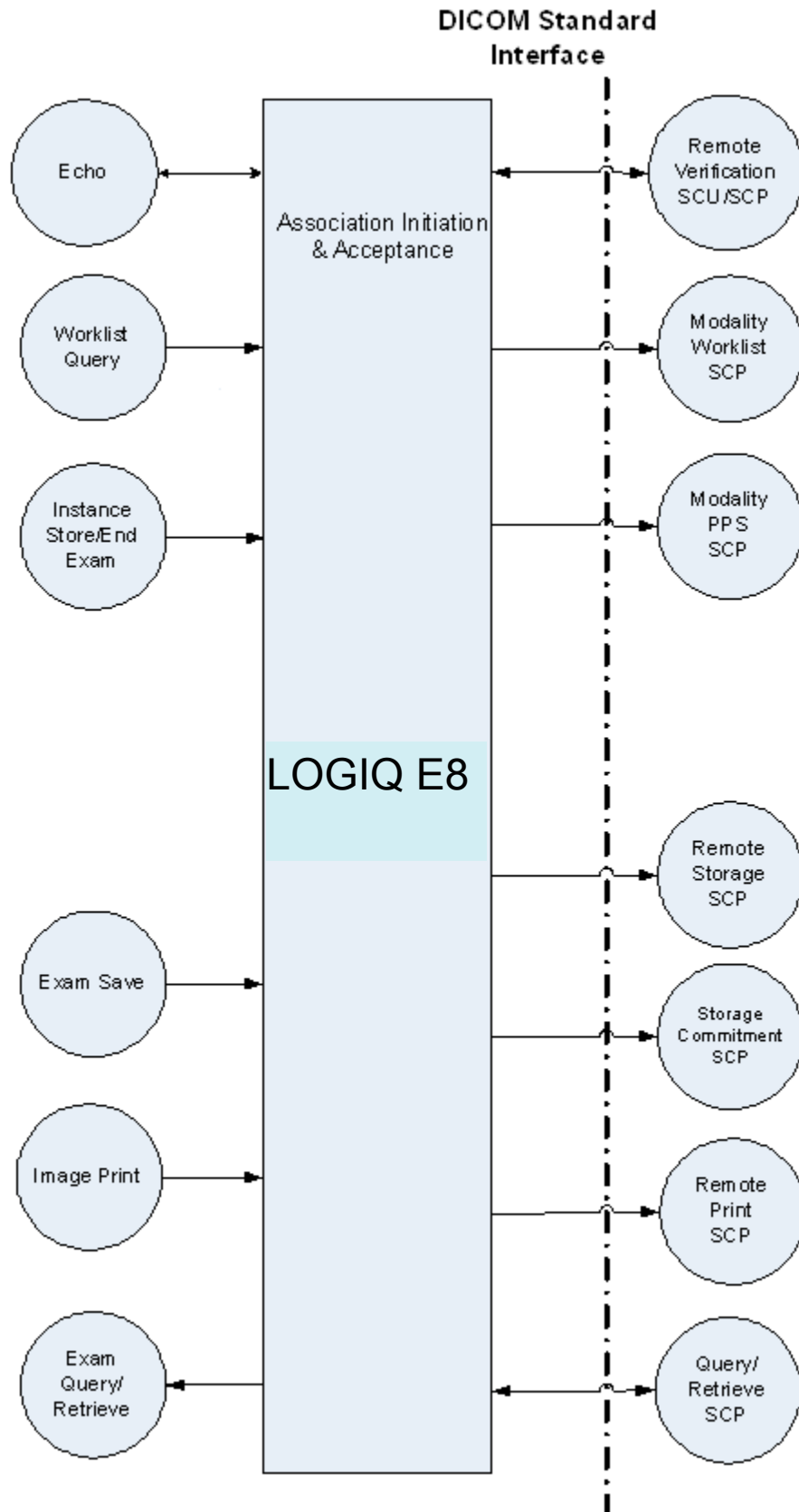

DIR DOC1585895 REV 2

There are six local real-world activities that occur in LOGIQ E8 - **Exam Save, Echo, Worklist Query, Image Store/End Exam, Image Print** and **Exam Query/Retrieve**

Exam save initiates a connection with the DICOM SCP and transmits images and results to the DICOM SCP. If Storage Commitment is configured a commitment request will be sent for the images and results.

Echo initiates a connection with the DICOM SCP, posts a Verification request and closes the connection. It also responds to incoming Verification requests (for service use).

Worklist Query initiates a connection with the DICOM SCP, performs a query and retrieves the matching entries to the product.

Image Store/End exam: If Modality Performed Procedure Step is configured N-CREATE and N-SET messages will be sent for the exam.

Image Print will send images to a DICOM Print SCP.

Exam Query/Retrieve initiates a connection with the DICOM SCP, performs a query and retrieves selected examination.

2.2.2 Functional Definition of AE's

Application Entity LOGIQ E8 supports the following functions:

Initiates a DICOM association to send images and results.

Initiates a DICOM verification to assist in network diagnostics.

Initiates a DICOM worklist query to receive worklist information.

Initiates a DICOM association to notify start of examination.

Initiates a DICOM association to notify end of examination.

Initiates a DICOM association to request storage commitment of images.

Responds to replies for storage commitment requests of images.

Initiates a DICOM association to print images.

Initiates a DICOM association to query for and retrieve examinations.

Responds to storage requests for images triggered by examination retrieve requests.

2.2.3 Sequencing of Real-World Activities

Non Applicable.

2.3 AE SPECIFICATIONS

2.3.1 LOGIQ E8 AE Specification

This Application Entity provides Standard Conformance to the following DICOM SOP Classes as an **SCU** and/or as an **SCP**:

SOP Class Name	SOP Class UID	SCU	SCP
Ultrasound Image Storage	1.2.840.10008.5.1.4.1.1.6.1	Yes	Yes
Ultrasound Image Storage (Retired)	1.2.840.10008.5.1.4.1.1.6	Yes	Yes
Ultrasound Multi-frame Image Storage	1.2.840.10008.5.1.4.1.1.3.1	Yes	Yes
Ultrasound Multi-frame Image Storage (Retired)	1.2.840.10008.5.1.4.1.1.3	Yes	Yes
Enhanced US Volume Storage	1.2.840.10008.5.1.4.1.1.6.2	Yes	Yes
Secondary Capture Image Storage	1.2.840.10008.5.1.4.1.1.7	Yes	Yes
Comprehensive SR	1.2.840.10008.5.1.4.1.1.88.33	Yes	No
Key Object Selection Document Storage	1.2.840.10008.5.1.4.1.1.88.59	Yes	No
Verification SOP Class	1.2.840.10008.1.1	Yes	Yes
Digital Mammography Image Storage - For Presentation	1.2.840.10008.5.1.4.1.1.1.2	Yes	Yes
Digital Mammography Image Storage - For Processing	1.2.840.10008.5.1.4.1.1.1.2.1	Yes	Yes
CT Image Storage	1.2.840.10008.5.1.4.1.1.2	Yes	Yes
MR Image Storage	1.2.840.10008.5.1.4.1.1.4	Yes	Yes
Positron Emission Tomography Image Storage	1.2.840.10008.5.1.4.1.1.128	Yes	Yes
Study Root Query/Retrieve Information Model - FIND	1.2.840.10008.5.1.4.1.2.2.1	Yes	No
Study Root Query/Retrieve Information Model - MOVE	1.2.840.10008.5.1.4.1.2.2.2	Yes	No
Modality Worklist Information Model - FIND	1.2.840.10008.5.1.4.31	Yes	No
Modality Performed Procedure Step	1.2.840.10008.3.1.2.3.3	Yes	No
Storage Commitment Push Model	1.2.840.10008.1.20.1	Yes	No
Basic Grayscale Print Management Meta SOP Class	1.2.840.10008.5.1.1.9	Yes	No
Basic Color Print Management Meta SOP Class	1.2.840.10008.5.1.1.18	Yes	No
Basic Annotation Box	1.2.840.10008.5.1.1.15	Yes	No
Printer SOP Class	1.2.840.10008.5.1.1.16	Yes	No
Basic Film Session SOP Class	1.2.840.10008.5.1.1.1	Yes	No
Basic Film Box SOP Class	1.2.840.10008.5.1.1.2	Yes	No
Basic Grayscale Image Box SOP Class	1.2.840.10008.5.1.1.4	Yes	No
Basic Color Image Box SOP Class	1.2.840.10008.5.1.1.4.1	Yes	No

DIR DOC1585895 REV 2

2.3.1.1 Association Establishment Policies**2.3.1.1.1 General**

The DICOM Application Context Name (ACN), which is always proposed, is:

Application Context Name	1.2.840.10008.3.1.1.1
---------------------------------	------------------------------

The Maximum Length PDU negotiation is included in all association establishment requests. The maximum length PDU for an association initiated by LOGIQ E8 is:

Maximum Length PDU	32768
---------------------------	--------------

The maximum length PDU is a fixed number - not configurable.

The SOP Class Extended Negotiation is not supported.

The user information Items sent by this product are:

Maximum PDU Length

Implementation UID

Implementation Version Name

2.3.1.1.2 Number of Associations

The LOGIQ E8 AE will initiate multiple DICOM associations. The maximum numbers of associations are based on the connectivity service configuration.

2.3.1.1.3 Asynchronous Nature

Asynchronous mode is not supported. All operations will be performed synchronously.

2.3.1.1.4 Implementation Identifying Information

The Implementation UID for this DICOM Implementation is:

LOGIQ E8 Implementation UID	1.2.840.113619.6.352
LOGIQ E8 Implementation Version Name	LOGIQE8_1

2.3.1.2 Association Initiation Policy

The LOGIQ E8 AE attempts to establish a new association with a remote device due to six Real-World Activities:
Exam save initiated by the operator for images, key object selection document and structured reports and sending request for Storage Commitment.

Verification, which verifies application level communication between peer DICOM AE's for service purposes.

Worklist initiated by the operator for receiving worklist information.

Image Store/End Exam sending messages to Modality Performed Procedure Step.

Print initiated by the operator for a specific image or group of images.

Exam Query/Retrieve initiated by the operator for receiving examination information and selecting examination to retrieve.

GE Healthcare

DIR DOC1585895 REV 2

2.3.1.2.1 Real-World Activity - 'Exam save' Operation

2.3.1.2.1.1 Associated Real-World Activity

Upon a request by the operator (manual or automatic), images will be sent to a DICOM Storage SCP.

2.3.1.2.1.2 Proposed Presentation Context Tables

The Proposed Presentation Context Table depends on compression according to the following table:

Presentation Context Table – Proposed					
Abstract Syntax		Transfer Syntax		Role	Extended Negotiation
Name	UID	Name List	UID List		
Presentation Context Table: Still Compression set to None, Clip/Volume Compression set to None					
Ultrasound Image Storage	1.2.840.10008.5.1.4.1.1.6.1	Explicit VR Little Endian Explicit VR Big Endian Implicit VR Little Endian	1.2.840.10008.1.2.1 1.2.840.10008.1.2.2 1.2.840.10008.1.2	SCU	None
Ultrasound Image Storage (retired)	1.2.840.10008.5.1.4.1.1.6	Explicit VR Little Endian Explicit VR Big Endian Implicit VR Little Endian	1.2.840.10008.1.2.1 1.2.840.10008.1.2.2 1.2.840.10008.1.2	SCU	None
Ultrasound Multi-frame Image Storage	1.2.840.10008.5.1.4.1.1.3.1	Explicit VR Little Endian Explicit VR Big Endian Implicit VR Little Endian	1.2.840.10008.1.2.1 1.2.840.10008.1.2.2 1.2.840.10008.1.2	SCU	None
Ultrasound Multi-frame Image Storage (retired)	1.2.840.10008.5.1.4.1.1.3	Explicit VR Little Endian Explicit VR Big Endian Implicit VR Little Endian	1.2.840.10008.1.2.1 1.2.840.10008.1.2.2 1.2.840.10008.1.2	SCU	None
Enhanced US Volume Storage	1.2.840.10008.5.1.4.1.1.6.2	Explicit VR Little Endian Explicit VR Big Endian Implicit VR Little Endian	1.2.840.10008.1.2.1 1.2.840.10008.1.2.2 1.2.840.10008.1.2	SCU	None
Secondary Capture Image Storage	1.2.840.10008.5.1.4.1.1.7	Explicit VR Little Endian Explicit VR Big Endian Implicit VR Little Endian	1.2.840.10008.1.2.1 1.2.840.10008.1.2.2 1.2.840.10008.1.2	SCU	None
CT Image Storage	1.2.840.10008.5.1.4.1.1.2	Explicit VR Little Endian Explicit VR Big Endian Implicit VR Little Endian	1.2.840.10008.1.2.1 1.2.840.10008.1.2.2 1.2.840.10008.1.2	SCU	None
MR Image Storage	1.2.840.10008.5.1.4.1.1.4	Explicit VR Little Endian Explicit VR Big Endian Implicit VR Little Endian	1.2.840.10008.1.2.1 1.2.840.10008.1.2.2 1.2.840.10008.1.2	SCU	None
Positron Emission Tomography Image Storage	1.2.840.10008.5.1.4.1.1.128	Explicit VR Little Endian Explicit VR Big Endian Implicit VR Little Endian	1.2.840.10008.1.2.1 1.2.840.10008.1.2.2 1.2.840.10008.1.2	SCU	None
Digital Mammography Storage For Presentation	1.2.840.10008.5.1.4.1.1.1.2	Explicit VR Little Endian Explicit VR Big Endian Implicit VR Little Endian	1.2.840.10008.1.2.1 1.2.840.10008.1.2.2 1.2.840.10008.1.2	SCU	None
Digital Mammography Storage For Processing	1.2.840.10008.5.1.4.1.1.1.2.1	Explicit VR Little Endian Explicit VR Big Endian Implicit VR Little Endian	1.2.840.10008.1.2.1 1.2.840.10008.1.2.2 1.2.840.10008.1.2	SCU	None
Presentation Context Table: Still Compression set to RLE, Clip/Volume Compression set to RLE					
Secondary Capture Image Storage	1.2.840.10008.5.1.4.1.1.7	Run Length Encoding	1.2.840.10008.1.2.5	SCU	None
Ultrasound Image Storage	1.2.840.10008.5.1.4.1.1.6.1	Run Length Encoding	1.2.840.10008.1.2.5	SCU	None
Ultrasound Image Storage (retired)	1.2.840.10008.5.1.4.1.1.6	Run Length Encoding	1.2.840.10008.1.2.5	SCU	None
Ultrasound Multi-frame Image Storage	1.2.840.10008.5.1.4.1.1.3.1	Run Length Encoding	1.2.840.10008.1.2.5	SCU	None
Enhanced US Volume Storage	1.2.840.10008.5.1.4.1.1.6.2	Run Length Encoding	1.2.840.10008.1.2.5	SCU	None
Ultrasound Multi-frame Image Storage	1.2.840.10008.5.1.4.1.1.3	Run Length Encoding	1.2.840.10008.1.2.5	SCU	None

(retired)					
Presentation Context Table: Still Compression set to JPEG Lossy, Clip/Volume Compression set to JPEG Lossy					
Secondary Capture Image Storage	1.2.840.10008.5.1.4.1.1.7	JPEG Baseline	1.2.840.10008.1.2.4.50	SCU	None
Ultrasound Image Storage	1.2.840.10008.5.1.4.1.1.6.1	JPEG Baseline	1.2.840.10008.1.2.4.50	SCU	None
Ultrasound Image Storage (retired)	1.2.840.10008.5.1.4.1.1.6	JPEG Baseline	1.2.840.10008.1.2.4.50	SCU	None
Ultrasound Multi-frame Image Storage	1.2.840.10008.5.1.4.1.1.3.1	JPEG Baseline	1.2.840.10008.1.2.4.50	SCU	None
Enhanced US Volume Storage	1.2.840.10008.5.1.4.1.1.6.2	JPEG Baseline	1.2.840.10008.1.2.4.50	SCU	None
Ultrasound Multi-frame Image Storage (retired)	1.2.840.10008.5.1.4.1.1.3	JPEG Baseline	1.2.840.10008.1.2.4.50	SCU	None
Presentation Context Table: Still Compression set to JPEG Lossless, Clip/Volume Compression set to JPEG Lossless					
Secondary Capture Image Storage	1.2.840.10008.5.1.4.1.1.7	JPEG Lossless Non Hierarchical (Proc 14)	1.2.840.10008.1.2.4.70	SCU	None
Ultrasound Image Storage	1.2.840.10008.5.1.4.1.1.6.1	JPEG Lossless Non Hierarchical (Proc 14)	1.2.840.10008.1.2.4.70	SCU	None
Ultrasound Image Storage (retired)	1.2.840.10008.5.1.4.1.1.6	JPEG Lossless Non Hierarchical (Proc 14)	1.2.840.10008.1.2.4.70	SCU	None
Ultrasound Multi-frame Image Storage	1.2.840.10008.5.1.4.1.1.3.1	JPEG Lossless Non Hierarchical (Proc 14)	1.2.840.10008.1.2.4.70	SCU	None
Enhanced US Volume Storage	1.2.840.10008.5.1.4.1.1.6.2	JPEG Lossless Non Hierarchical (Proc 14)	1.2.840.10008.1.2.4.70	SCU	None
Ultrasound Multi-frame Image Storage (retired)	1.2.840.10008.5.1.4.1.1.3	JPEG Lossless Non Hierarchical (Proc 14)	1.2.840.10008.1.2.4.70	SCU	None
Presentation Context Table: Still Compression set to JPEG 2000 Lossy, Clip/Volume Compression set to JPEG 2000 Lossy					
Secondary Capture Image Storage	1.2.840.10008.5.1.4.1.1.7	JPEG 2000 Lossy	1.2.840.10008.1.2.4.91	SCU	None
Ultrasound Image Storage	1.2.840.10008.5.1.4.1.1.6.1	JPEG 2000 Lossy	1.2.840.10008.1.2.4.91	SCU	None
Ultrasound Image Storage (retired)	1.2.840.10008.5.1.4.1.1.6	JPEG 2000 Lossy	1.2.840.10008.1.2.4.91	SCU	None
Ultrasound Multi-frame Image Storage	1.2.840.10008.5.1.4.1.1.3.1	JPEG 2000 Lossy	1.2.840.10008.1.2.4.91	SCU	None
Enhanced US Volume Storage	1.2.840.10008.5.1.4.1.1.6.2	JPEG 2000 Lossy	1.2.840.10008.1.2.4.91	SCU	None
Ultrasound Multi-frame Image Storage (retired)	1.2.840.10008.5.1.4.1.1.3	JPEG 2000 Lossy	1.2.840.10008.1.2.4.91	SCU	None
Presentation Context Table: Still Compression set to JPEG 2000 Lossless, Clip/Volume Compression set to JPEG 2000 Lossless					
Secondary Capture Image Storage	1.2.840.10008.5.1.4.1.1.7	JPEG 2000 Lossless	1.2.840.10008.1.2.4.90	SCU	None
Ultrasound Image Storage	1.2.840.10008.5.1.4.1.1.6.1	JPEG 2000 Lossless	1.2.840.10008.1.2.4.90	SCU	None
Ultrasound Image Storage (retired)	1.2.840.10008.5.1.4.1.1.6	JPEG 2000 Lossless	1.2.840.10008.1.2.4.90	SCU	None
Ultrasound Multi-frame Image Storage	1.2.840.10008.5.1.4.1.1.3.1	JPEG 2000 Lossless	1.2.840.10008.1.2.4.90	SCU	None
Enhanced US Volume Storage	1.2.840.10008.5.1.4.1.1.6.2	JPEG 2000 Lossless	1.2.840.10008.1.2.4.90	SCU	None
Ultrasound Multi-	1.2.840.10008.5.1.4.1.1.3	JPEG 2000 Lossless	1.2.840.10008.1.2.4.90	SCU	None

frame Image Storage (retired)					
Presentation Context Table: Still Compression set to None, Clip/Volume Compression set to RLE					
Secondary Capture Image Storage	1.2.840.10008.5.1.4.1.1.7	Explicit VR Little Endian Explicit VR Big Endian Implicit VR Little Endian	1.2.840.10008.1.2.1 1.2.840.10008.1.2.2 1.2.840.10008.1.2	SCU	None
Ultrasound Image Storage	1.2.840.10008.5.1.4.1.1.6.1	Explicit VR Little Endian Explicit VR Big Endian Implicit VR Little Endian	1.2.840.10008.1.2.1 1.2.840.10008.1.2.2 1.2.840.10008.1.2	SCU	None
Ultrasound Image Storage (retired)	1.2.840.10008.5.1.4.1.1.6	Explicit VR Little Endian Explicit VR Big Endian Implicit VR Little Endian	1.2.840.10008.1.2.1 1.2.840.10008.1.2.2 1.2.840.10008.1.2	SCU	None
Ultrasound Multi-frame Image Storage	1.2.840.10008.5.1.4.1.1.3.1	Run Length Encoding	1.2.840.10008.1.2.5	SCU	None
Enhanced US Volume Storage	1.2.840.10008.5.1.4.1.1.6.2	Run Length Encoding	1.2.840.10008.1.2.5	SCU	None
Ultrasound Multi-frame Image Storage (retired)	1.2.840.10008.5.1.4.1.1.3	Run Length Encoding	1.2.840.10008.1.2.5	SCU	None
Presentation Context Table: Still Compression set to None, Clip/Volume Compression set to JPEG Lossy					
Secondary Capture Image Storage	1.2.840.10008.5.1.4.1.1.7	Explicit VR Little Endian Explicit VR Big Endian Implicit VR Little Endian	1.2.840.10008.1.2.1 1.2.840.10008.1.2.2 1.2.840.10008.1.2	SCU	None
Ultrasound Image Storage	1.2.840.10008.5.1.4.1.1.6.1	Explicit VR Little Endian Explicit VR Big Endian Implicit VR Little Endian	1.2.840.10008.1.2.1 1.2.840.10008.1.2.2 1.2.840.10008.1.2	SCU	None
Ultrasound Image Storage (retired)	1.2.840.10008.5.1.4.1.1.6	Explicit VR Little Endian Explicit VR Big Endian Implicit VR Little Endian	1.2.840.10008.1.2.1 1.2.840.10008.1.2.2 1.2.840.10008.1.2	SCU	None
Ultrasound Multi-frame Image Storage	1.2.840.10008.5.1.4.1.1.3.1	JPEG Baseline	1.2.840.10008.1.2.4.50	SCU	None
Enhanced US Volume Storage	1.2.840.10008.5.1.4.1.1.6.2	JPEG Baseline	1.2.840.10008.1.2.4.50	SCU	None
Ultrasound Multi-frame Image Storage (retired)	1.2.840.10008.5.1.4.1.1.3	JPEG Baseline	1.2.840.10008.1.2.4.50	SCU	None
Presentation Context Table: Still Compression set to None, Clip/Volume Compression set to JPEG Lossless					
Secondary Capture Image Storage	1.2.840.10008.5.1.4.1.1.7	Explicit VR Little Endian Explicit VR Big Endian Implicit VR Little Endian	1.2.840.10008.1.2.1 1.2.840.10008.1.2.2 1.2.840.10008.1.2	SCU	None
Ultrasound Image Storage	1.2.840.10008.5.1.4.1.1.6.1	Explicit VR Little Endian Explicit VR Big Endian Implicit VR Little Endian	1.2.840.10008.1.2.1 1.2.840.10008.1.2.2 1.2.840.10008.1.2	SCU	None
Ultrasound Image Storage (retired)	1.2.840.10008.5.1.4.1.1.6	Explicit VR Little Endian Explicit VR Big Endian Implicit VR Little Endian	1.2.840.10008.1.2.1 1.2.840.10008.1.2.2 1.2.840.10008.1.2	SCU	None
Ultrasound Multi-frame Image Storage	1.2.840.10008.5.1.4.1.1.3.1	JPEG Lossless Non Hierarchical (Proc 14)	1.2.840.10008.1.2.4.70	SCU	None
Enhanced US Volume Storage	1.2.840.10008.5.1.4.1.1.6.2	JPEG Lossless Non Hierarchical (Proc 14)	1.2.840.10008.1.2.4.70	SCU	None
Ultrasound Multi-frame Image Storage (retired)	1.2.840.10008.5.1.4.1.1.3	JPEG Lossless Non Hierarchical (Proc 14)	1.2.840.10008.1.2.4.70	SCU	None
Presentation Context Table: Still Compression set to None, Clip/Volume Compression set to JPEG 2000 Lossy					
Secondary Capture Image Storage	1.2.840.10008.5.1.4.1.1.7	Explicit VR Little Endian Explicit VR Big Endian	1.2.840.10008.1.2.1 1.2.840.10008.1.2.2	SCU	None

		Implicit VR Little Endian	1.2.840.10008.1.2		
Ultrasound Image Storage	1.2.840.10008.5.1.4.1.1.6.1	Explicit VR Little Endian Explicit VR Big Endian Implicit VR Little Endian	1.2.840.10008.1.2.1 1.2.840.10008.1.2.2 1.2.840.10008.1.2	SCU	None
Ultrasound Image Storage (retired)	1.2.840.10008.5.1.4.1.1.6	Explicit VR Little Endian Explicit VR Big Endian Implicit VR Little Endian	1.2.840.10008.1.2.1 1.2.840.10008.1.2.2 1.2.840.10008.1.2	SCU	None
Ultrasound Multi-frame Image Storage	1.2.840.10008.5.1.4.1.1.3.1	JPEG 2000 Lossy	1.2.840.10008.1.2.4.91	SCU	None
Enhanced US Volume Storage	1.2.840.10008.5.1.4.1.1.6.2	JPEG 2000 Lossy	1.2.840.10008.1.2.4.91	SCU	None
Ultrasound Multi-frame Image Storage (retired)	1.2.840.10008.5.1.4.1.1.3	JPEG 2000 Lossy	1.2.840.10008.1.2.4.91	SCU	None
Presentation Context Table: Still Compression set to None, Clip/Volume Compression set to JPEG 2000 Lossless					
Secondary Capture Image Storage	1.2.840.10008.5.1.4.1.1.7	Explicit VR Little Endian Explicit VR Big Endian Implicit VR Little Endian	1.2.840.10008.1.2.1 1.2.840.10008.1.2.2 1.2.840.10008.1.2	SCU	None
Ultrasound Image Storage	1.2.840.10008.5.1.4.1.1.6.1	Explicit VR Little Endian Explicit VR Big Endian Implicit VR Little Endian	1.2.840.10008.1.2.1 1.2.840.10008.1.2.2 1.2.840.10008.1.2	SCU	None
Ultrasound Image Storage (retired)	1.2.840.10008.5.1.4.1.1.6	Explicit VR Little Endian Explicit VR Big Endian Implicit VR Little Endian	1.2.840.10008.1.2.1 1.2.840.10008.1.2.2 1.2.840.10008.1.2	SCU	None
Ultrasound Multi-frame Image Storage	1.2.840.10008.5.1.4.1.1.3.1	JPEG 2000 Lossless	1.2.840.10008.1.2.4.90	SCU	None
Enhanced US Volume Storage	1.2.840.10008.5.1.4.1.1.6.2	JPEG 2000 Lossless	1.2.840.10008.1.2.4.90	SCU	None
Ultrasound Multi-frame Image Storage (retired)	1.2.840.10008.5.1.4.1.1.3	JPEG 2000 Lossless	1.2.840.10008.1.2.4.90	SCU	None
Presentation Context Table: Still Compression set to RLE, Clip/Volume Compression set to None					
Secondary Capture Image Storage	1.2.840.10008.5.1.4.1.1.7	Run Length Encoding	1.2.840.10008.1.2.5	SCU	None
Ultrasound Image Storage	1.2.840.10008.5.1.4.1.1.6.1	Run Length Encoding	1.2.840.10008.1.2.5	SCU	None
Ultrasound Image Storage (retired)	1.2.840.10008.5.1.4.1.1.6	Run Length Encoding	1.2.840.10008.1.2.5	SCU	None
Ultrasound Multi-frame Image Storage	1.2.840.10008.5.1.4.1.1.3.1	Explicit VR Little Endian Explicit VR Big Endian Implicit VR Little Endian	1.2.840.10008.1.2.1 1.2.840.10008.1.2.2 1.2.840.10008.1.2	SCU	None
Enhanced US Volume Storage	1.2.840.10008.5.1.4.1.1.6.2	Explicit VR Little Endian Explicit VR Big Endian Implicit VR Little Endian	1.2.840.10008.1.2.1 1.2.840.10008.1.2.2 1.2.840.10008.1.2	SCU	None
Ultrasound Multi-frame Image Storage (retired)	1.2.840.10008.5.1.4.1.1.3	Explicit VR Little Endian Explicit VR Big Endian Implicit VR Little Endian	1.2.840.10008.1.2.1 1.2.840.10008.1.2.2 1.2.840.10008.1.2	SCU	None
Presentation Context Table: Still Compression set to RLE, Clip/Volume Compression set to JPEG Lossy					
Secondary Capture Image Storage	1.2.840.10008.5.1.4.1.1.7	Run Length Encoding	1.2.840.10008.1.2.5	SCU	None
Ultrasound Image Storage	1.2.840.10008.5.1.4.1.1.6.1	Run Length Encoding	1.2.840.10008.1.2.5	SCU	None
Ultrasound Image Storage (retired)	1.2.840.10008.5.1.4.1.1.6	Run Length Encoding	1.2.840.10008.1.2.5	SCU	None
Ultrasound Multi-frame Image Storage	1.2.840.10008.5.1.4.1.1.3.1	JPEG Baseline	1.2.840.10008.1.2.4.50	SCU	None
Enhanced US Volume Storage	1.2.840.10008.5.1.4.1.1.6.2	JPEG Baseline	1.2.840.10008.1.2.4.50	SCU	None

Ultrasound Multi-frame Image Storage (retired)	1.2.840.10008.5.1.4.1.1.3	JPEG Baseline	1.2.840.10008.1.2.4.50	SCU	None
Presentation Context Table: Still Compression set to RLE, Clip/Volume Compression set to JPEG Lossless					
Secondary Capture Image Storage	1.2.840.10008.5.1.4.1.1.7	Run Length Encoding	1.2.840.10008.1.2.5	SCU	None
Ultrasound Image Storage	1.2.840.10008.5.1.4.1.1.6.1	Run Length Encoding	1.2.840.10008.1.2.5	SCU	None
Ultrasound Image Storage (retired)	1.2.840.10008.5.1.4.1.1.6	Run Length Encoding	1.2.840.10008.1.2.5	SCU	None
Ultrasound Multi-frame Image Storage	1.2.840.10008.5.1.4.1.1.3.1	JPEG Lossless Non Hierarchical (Proc 14)	1.2.840.10008.1.2.4.70	SCU	None
Enhanced US Volume Storage	1.2.840.10008.5.1.4.1.1.6.2	JPEG Lossless Non Hierarchical (Proc 14)	1.2.840.10008.1.2.4.70	SCU	None
Ultrasound Multi-frame Image Storage (retired)	1.2.840.10008.5.1.4.1.1.3	JPEG Lossless Non Hierarchical (Proc 14)	1.2.840.10008.1.2.4.70	SCU	None
Presentation Context Table: Still Compression set to RLE, Clip/Volume Compression set to JPEG 2000 Lossy					
Secondary Capture Image Storage	1.2.840.10008.5.1.4.1.1.7	Run Length Encoding	1.2.840.10008.1.2.5	SCU	None
Ultrasound Image Storage	1.2.840.10008.5.1.4.1.1.6.1	Run Length Encoding	1.2.840.10008.1.2.5	SCU	None
Ultrasound Image Storage (retired)	1.2.840.10008.5.1.4.1.1.6	Run Length Encoding	1.2.840.10008.1.2.5	SCU	None
Ultrasound Multi-frame Image Storage	1.2.840.10008.5.1.4.1.1.3.1	JPEG 2000 Lossy	1.2.840.10008.1.2.4.91	SCU	None
Enhanced US Volume Storage	1.2.840.10008.5.1.4.1.1.6.2	JPEG 2000 Lossy	1.2.840.10008.1.2.4.91	SCU	None
Ultrasound Multi-frame Image Storage (retired)	1.2.840.10008.5.1.4.1.1.3	JPEG 2000 Lossy	1.2.840.10008.1.2.4.91	SCU	None
Presentation Context Table: Still Compression set to RLE, Clip/Volume Compression set to JPEG 2000 Lossless					
Secondary Capture Image Storage	1.2.840.10008.5.1.4.1.1.7	Run Length Encoding	1.2.840.10008.1.2.5	SCU	None
Ultrasound Image Storage	1.2.840.10008.5.1.4.1.1.6.1	Run Length Encoding	1.2.840.10008.1.2.5	SCU	None
Ultrasound Image Storage (retired)	1.2.840.10008.5.1.4.1.1.6	Run Length Encoding	1.2.840.10008.1.2.5	SCU	None
Ultrasound Multi-frame Image Storage	1.2.840.10008.5.1.4.1.1.3.1	JPEG 2000 Lossless	1.2.840.10008.1.2.4.90	SCU	None
Enhanced US Volume Storage	1.2.840.10008.5.1.4.1.1.6.2	JPEG 2000 Lossless	1.2.840.10008.1.2.4.90	SCU	None
Ultrasound Multi-frame Image Storage (retired)	1.2.840.10008.5.1.4.1.1.3	JPEG 2000 Lossless	1.2.840.10008.1.2.4.90	SCU	None
Presentation Context Table: Still Compression set to JPEG Lossy, Clip/Volume Compression set to None					
Secondary Capture Image Storage	1.2.840.10008.5.1.4.1.1.7	JPEG Baseline	1.2.840.10008.1.2.4.50	SCU	None
Ultrasound Image Storage	1.2.840.10008.5.1.4.1.1.6.1	JPEG Baseline	1.2.840.10008.1.2.4.50	SCU	None
Ultrasound Image Storage (retired)	1.2.840.10008.5.1.4.1.1.6	JPEG Baseline	1.2.840.10008.1.2.4.50	SCU	None
Ultrasound Multi-frame Image Storage	1.2.840.10008.5.1.4.1.1.3.1	Explicit VR Little Endian Explicit VR Big Endian Implicit VR Little Endian	1.2.840.10008.1.2.1 1.2.840.10008.1.2.2 1.2.840.10008.1.2	SCU	None

Enhanced US Volume Storage	1.2.840.10008.5.1.4.1.1.6.2	Explicit VR Little Endian Explicit VR Big Endian Implicit VR Little Endian	1.2.840.10008.1.2.1 1.2.840.10008.1.2.2 1.2.840.10008.1.2	SCU	None
Ultrasound Multi-frame Image Storage (retired)	1.2.840.10008.5.1.4.1.1.3	Explicit VR Little Endian Explicit VR Big Endian Implicit VR Little Endian	1.2.840.10008.1.2.1 1.2.840.10008.1.2.2 1.2.840.10008.1.2	SCU	None
Presentation Context Table: Still Compression set to JPEG Lossy, Clip/Volume Compression set to RLE					
Secondary Capture Image Storage	1.2.840.10008.5.1.4.1.1.7	JPEG Baseline	1.2.840.10008.1.2.4.50	SCU	None
Ultrasound Image Storage	1.2.840.10008.5.1.4.1.1.6.1	JPEG Baseline	1.2.840.10008.1.2.4.50	SCU	None
Ultrasound Image Storage (retired)	1.2.840.10008.5.1.4.1.1.6	JPEG Baseline	1.2.840.10008.1.2.4.50	SCU	None
Ultrasound Multi-frame Image Storage	1.2.840.10008.5.1.4.1.1.3.1	Run Length Encoding	1.2.840.10008.1.2.5	SCU	None
Enhanced US Volume Storage	1.2.840.10008.5.1.4.1.1.6.2	Run Length Encoding	1.2.840.10008.1.2.5	SCU	None
Ultrasound Multi-frame Image Storage (retired)	1.2.840.10008.5.1.4.1.1.3	Run Length Encoding	1.2.840.10008.1.2.5	SCU	None
Presentation Context Table: Still Compression set to JPEG Lossy, Clip/Volume Compression set to JPEG Lossless					
Secondary Capture Image Storage	1.2.840.10008.5.1.4.1.1.7	JPEG Baseline	1.2.840.10008.1.2.4.50	SCU	None
Ultrasound Image Storage	1.2.840.10008.5.1.4.1.1.6.1	JPEG Baseline	1.2.840.10008.1.2.4.50	SCU	None
Ultrasound Image Storage (retired)	1.2.840.10008.5.1.4.1.1.6	JPEG Baseline	1.2.840.10008.1.2.4.50	SCU	None
Ultrasound Multi-frame Image Storage	1.2.840.10008.5.1.4.1.1.3.1	JPEG Lossless Non Hierarchical (Proc 14)	1.2.840.10008.1.2.4.70	SCU	None
Enhanced US Volume Storage	1.2.840.10008.5.1.4.1.1.6.2	JPEG Lossless Non Hierarchical (Proc 14)	1.2.840.10008.1.2.4.70	SCU	None
Ultrasound Multi-frame Image Storage (retired)	1.2.840.10008.5.1.4.1.1.3	JPEG Lossless Non Hierarchical (Proc 14)	1.2.840.10008.1.2.4.70	SCU	None
Presentation Context Table: Still Compression set to JPEG Lossy, Clip/Volume Compression set to JPEG 2000 Lossy					
Secondary Capture Image Storage	1.2.840.10008.5.1.4.1.1.7	JPEG Baseline	1.2.840.10008.1.2.4.50	SCU	None
Ultrasound Image Storage	1.2.840.10008.5.1.4.1.1.6.1	JPEG Baseline	1.2.840.10008.1.2.4.50	SCU	None
Ultrasound Image Storage (retired)	1.2.840.10008.5.1.4.1.1.6	JPEG Baseline	1.2.840.10008.1.2.4.50	SCU	None
Ultrasound Multi-frame Image Storage	1.2.840.10008.5.1.4.1.1.3.1	JPEG 2000 Lossy	1.2.840.10008.1.2.4.91	SCU	None
Enhanced US Volume Storage	1.2.840.10008.5.1.4.1.1.6.2	JPEG 2000 Lossy	1.2.840.10008.1.2.4.91	SCU	None
Ultrasound Multi-frame Image Storage (retired)	1.2.840.10008.5.1.4.1.1.3	JPEG 2000 Lossy	1.2.840.10008.1.2.4.91	SCU	None
Presentation Context Table: Still Compression set to JPEG Lossy, Clip/Volume Compression set to JPEG 2000 Lossless					
Secondary Capture Image Storage	1.2.840.10008.5.1.4.1.1.7	JPEG Baseline	1.2.840.10008.1.2.4.50	SCU	None
Ultrasound Image Storage	1.2.840.10008.5.1.4.1.1.6.1	JPEG Baseline	1.2.840.10008.1.2.4.50	SCU	None
Ultrasound Image Storage (retired)	1.2.840.10008.5.1.4.1.1.6	JPEG Baseline	1.2.840.10008.1.2.4.50	SCU	None

Ultrasound Multi-frame Image Storage	1.2.840.10008.5.1.4.1.1.3.1	JPEG 2000 Lossless	1.2.840.10008.1.2.4.90	SCU	None
Enhanced US Volume Storage	1.2.840.10008.5.1.4.1.1.6.2	JPEG 2000 Lossless	1.2.840.10008.1.2.4.90	SCU	None
Ultrasound Multi-frame Image Storage (retired)	1.2.840.10008.5.1.4.1.1.3	JPEG 2000 Lossless	1.2.840.10008.1.2.4.90	SCU	None
Presentation Context Table: Still Compression set to JPEG Lossless, Clip/Volume Compression set to None					
Secondary Capture Image Storage	1.2.840.10008.5.1.4.1.1.7	JPEG Lossless Non Hierarchical (Proc 14)	1.2.840.10008.1.2.4.70	SCU	None
Ultrasound Image Storage	1.2.840.10008.5.1.4.1.1.6.1	JPEG Lossless Non Hierarchical (Proc 14)	1.2.840.10008.1.2.4.70	SCU	None
Ultrasound Image Storage (retired)	1.2.840.10008.5.1.4.1.1.6	JPEG Lossless Non Hierarchical (Proc 14)	1.2.840.10008.1.2.4.70	SCU	None
Ultrasound Multi-frame Image Storage	1.2.840.10008.5.1.4.1.1.3.1	Explicit VR Little Endian Explicit VR Big Endian Implicit VR Little Endian	1.2.840.10008.1.2.1 1.2.840.10008.1.2.2 1.2.840.10008.1.2	SCU	None
Enhanced US Volume Storage	1.2.840.10008.5.1.4.1.1.6.2	Explicit VR Little Endian Explicit VR Big Endian Implicit VR Little Endian	1.2.840.10008.1.2.1 1.2.840.10008.1.2.2 1.2.840.10008.1.2	SCU	None
Ultrasound Multi-frame Image Storage (retired)	1.2.840.10008.5.1.4.1.1.3	Explicit VR Little Endian Explicit VR Big Endian Implicit VR Little Endian	1.2.840.10008.1.2.1 1.2.840.10008.1.2.2 1.2.840.10008.1.2	SCU	None
Presentation Context Table: Still Compression set to JPEG Lossless, Clip/Volume Compression set to RLE					
Secondary Capture Image Storage	1.2.840.10008.5.1.4.1.1.7	JPEG Lossless Non Hierarchical (Proc 14)	1.2.840.10008.1.2.4.70	SCU	None
Ultrasound Image Storage	1.2.840.10008.5.1.4.1.1.6.1	JPEG Lossless Non Hierarchical (Proc 14)	1.2.840.10008.1.2.4.70	SCU	None
Ultrasound Image Storage (retired)	1.2.840.10008.5.1.4.1.1.6	JPEG Lossless Non Hierarchical (Proc 14)	1.2.840.10008.1.2.4.70	SCU	None
Ultrasound Multi-frame Image Storage	1.2.840.10008.5.1.4.1.1.3.1	Run Length Encoding	1.2.840.10008.1.2.5	SCU	None
Enhanced US Volume Storage	1.2.840.10008.5.1.4.1.1.6.2	Run Length Encoding	1.2.840.10008.1.2.5	SCU	None
Ultrasound Multi-frame Image Storage (retired)	1.2.840.10008.5.1.4.1.1.3	Run Length Encoding	1.2.840.10008.1.2.5	SCU	None
Presentation Context Table: Still Compression set to JPEG Lossless, Clip/Volume Compression set to JPEG Lossy					
Secondary Capture Image Storage	1.2.840.10008.5.1.4.1.1.7	JPEG Lossless Non Hierarchical (Proc 14)	1.2.840.10008.1.2.4.70	SCU	None
Ultrasound Image Storage	1.2.840.10008.5.1.4.1.1.6.1	JPEG Lossless Non Hierarchical (Proc 14)	1.2.840.10008.1.2.4.70	SCU	None
Ultrasound Image Storage (retired)	1.2.840.10008.5.1.4.1.1.6	JPEG Lossless Non Hierarchical (Proc 14)	1.2.840.10008.1.2.4.70	SCU	None
Ultrasound Multi-frame Image Storage	1.2.840.10008.5.1.4.1.1.3.1	JPEG Baseline	1.2.840.10008.1.2.4.50	SCU	None
Enhanced US Volume Storage	1.2.840.10008.5.1.4.1.1.6.2	JPEG Baseline	1.2.840.10008.1.2.4.50	SCU	None
Ultrasound Multi-frame Image Storage (retired)	1.2.840.10008.5.1.4.1.1.3	JPEG Baseline	1.2.840.10008.1.2.4.50	SCU	None
Presentation Context Table: Still Compression set to JPEG Lossless, Clip/Volume Compression set to JPEG 2000 Lossy					
Secondary Capture Image Storage	1.2.840.10008.5.1.4.1.1.7	JPEG Lossless Non Hierarchical (Proc 14)	1.2.840.10008.1.2.4.70	SCU	None
Ultrasound Image Storage	1.2.840.10008.5.1.4.1.1.6.1	JPEG Lossless Non Hierarchical (Proc 14)	1.2.840.10008.1.2.4.70	SCU	None

Storage		Hierarchical (Proc 14)			
Ultrasound Image Storage (retired)	1.2.840.10008.5.1.4.1.1.6	JPEG Lossless Non Hierarchical (Proc 14)	1.2.840.10008.1.2.4.70	SCU	None
Ultrasound Multi-frame Image Storage	1.2.840.10008.5.1.4.1.1.3.1	JPEG 2000 Lossy	1.2.840.10008.1.2.4.91	SCU	None
Enhanced US Volume Storage	1.2.840.10008.5.1.4.1.1.6.2	JPEG 2000 Lossy	1.2.840.10008.1.2.4.91	SCU	None
Ultrasound Multi-frame Image Storage (retired)	1.2.840.10008.5.1.4.1.1.3	JPEG 2000 Lossy	1.2.840.10008.1.2.4.91	SCU	None
Presentation Context Table: Still Compression set to JPEG Lossless, Clip/Volume Compression set to JPEG 2000 Lossless					
Secondary Capture Image Storage	1.2.840.10008.5.1.4.1.1.7	JPEG Lossless Non Hierarchical (Proc 14)	1.2.840.10008.1.2.4.70	SCU	None
Ultrasound Image Storage	1.2.840.10008.5.1.4.1.1.6.1	JPEG Lossless Non Hierarchical (Proc 14)	1.2.840.10008.1.2.4.70	SCU	None
Ultrasound Image Storage (retired)	1.2.840.10008.5.1.4.1.1.6	JPEG Lossless Non Hierarchical (Proc 14)	1.2.840.10008.1.2.4.70	SCU	None
Ultrasound Multi-frame Image Storage	1.2.840.10008.5.1.4.1.1.3.1	JPEG 2000 Lossless	1.2.840.10008.1.2.4.90	SCU	None
Enhanced US Volume Storage	1.2.840.10008.5.1.4.1.1.6.2	JPEG 2000 Lossless	1.2.840.10008.1.2.4.90	SCU	None
Ultrasound Multi-frame Image Storage (retired)	1.2.840.10008.5.1.4.1.1.3	JPEG 2000 Lossless	1.2.840.10008.1.2.4.90	SCU	None
Presentation Context Table: Still Compression set to JPEG 2000 Lossy, Clip/Volume Compression set to None					
Secondary Capture Image Storage	1.2.840.10008.5.1.4.1.1.7	JPEG 2000 Lossy	1.2.840.10008.1.2.4.91	SCU	None
Ultrasound Image Storage	1.2.840.10008.5.1.4.1.1.6.1	JPEG 2000 Lossy	1.2.840.10008.1.2.4.91	SCU	None
Ultrasound Image Storage (retired)	1.2.840.10008.5.1.4.1.1.6	JPEG 2000 Lossy	1.2.840.10008.1.2.4.91	SCU	None
Ultrasound Multi-frame Image Storage	1.2.840.10008.5.1.4.1.1.3.1	Explicit VR Little Endian Explicit VR Big Endian Implicit VR Little Endian	1.2.840.10008.1.2.1 1.2.840.10008.1.2.2 1.2.840.10008.1.2	SCU	None
Enhanced US Volume Storage	1.2.840.10008.5.1.4.1.1.6.2	Explicit VR Little Endian Explicit VR Big Endian Implicit VR Little Endian	1.2.840.10008.1.2.1 1.2.840.10008.1.2.2 1.2.840.10008.1.2	SCU	None
Ultrasound Multi-frame Image Storage (retired)	1.2.840.10008.5.1.4.1.1.3	Explicit VR Little Endian Explicit VR Big Endian Implicit VR Little Endian	1.2.840.10008.1.2.1 1.2.840.10008.1.2.2 1.2.840.10008.1.2	SCU	None
Presentation Context Table: Still Compression set to JPEG 2000 Lossy, Clip/Volume Compression set to RLE					
Secondary Capture Image Storage	1.2.840.10008.5.1.4.1.1.7	JPEG 2000 Lossy	1.2.840.10008.1.2.4.91	SCU	None
Ultrasound Image Storage	1.2.840.10008.5.1.4.1.1.6.1	JPEG 2000 Lossy	1.2.840.10008.1.2.4.91	SCU	None
Ultrasound Image Storage (retired)	1.2.840.10008.5.1.4.1.1.6	JPEG 2000 Lossy	1.2.840.10008.1.2.4.91	SCU	None
Ultrasound Multi-frame Image Storage	1.2.840.10008.5.1.4.1.1.3.1	Run Length Encoding	1.2.840.10008.1.2.5	SCU	None
Enhanced US Volume Storage	1.2.840.10008.5.1.4.1.1.6.2	Run Length Encoding	1.2.840.10008.1.2.5	SCU	None
Ultrasound Multi-frame Image Storage (retired)	1.2.840.10008.5.1.4.1.1.3	Run Length Encoding	1.2.840.10008.1.2.5	SCU	None
Presentation Context Table: Still Compression set to JPEG 2000 Lossy, Clip/Volume Compression set to JPEG Lossy					

DIR DOC1585895 REV 2

Secondary Capture Image Storage	1.2.840.10008.5.1.4.1.1.7	JPEG 2000 Lossy	1.2.840.10008.1.2.4.91	SCU	None
Ultrasound Image Storage	1.2.840.10008.5.1.4.1.1.6.1	JPEG 2000 Lossy	1.2.840.10008.1.2.4.91	SCU	None
Ultrasound Image Storage (retired)	1.2.840.10008.5.1.4.1.1.6	JPEG 2000 Lossy	1.2.840.10008.1.2.4.91	SCU	None
Ultrasound Multi-frame Image Storage	1.2.840.10008.5.1.4.1.1.3.1	JPEG Baseline	1.2.840.10008.1.2.4.50	SCU	None
Enhanced US Volume Storage	1.2.840.10008.5.1.4.1.1.6.2	JPEG Baseline	1.2.840.10008.1.2.4.50	SCU	None
Ultrasound Multi-frame Image Storage (retired)	1.2.840.10008.5.1.4.1.1.3	JPEG Baseline	1.2.840.10008.1.2.4.50	SCU	None
Presentation Context Table: Still Compression set to JPEG 2000 Lossy, Clip/Volume Compression set to JPEG Lossless					
Secondary Capture Image Storage	1.2.840.10008.5.1.4.1.1.7	JPEG 2000 Lossy	1.2.840.10008.1.2.4.91	SCU	None
Ultrasound Image Storage	1.2.840.10008.5.1.4.1.1.6.1	JPEG 2000 Lossy	1.2.840.10008.1.2.4.91	SCU	None
Ultrasound Image Storage (retired)	1.2.840.10008.5.1.4.1.1.6	JPEG 2000 Lossy	1.2.840.10008.1.2.4.91	SCU	None
Ultrasound Multi-frame Image Storage	1.2.840.10008.5.1.4.1.1.3.1	JPEG Lossless Non Hierarchical (Proc 14)	1.2.840.10008.1.2.4.70	SCU	None
Enhanced US Volume Storage	1.2.840.10008.5.1.4.1.1.6.2	JPEG Lossless Non Hierarchical (Proc 14)	1.2.840.10008.1.2.4.70	SCU	None
Ultrasound Multi-frame Image Storage (retired)	1.2.840.10008.5.1.4.1.1.3	JPEG Lossless Non Hierarchical (Proc 14)	1.2.840.10008.1.2.4.70	SCU	None
Presentation Context Table: Still Compression set to JPEG 2000 Lossy, Clip/Volume Compression set to JPEG 2000 Lossless					
Secondary Capture Image Storage	1.2.840.10008.5.1.4.1.1.7	JPEG 2000 Lossy	1.2.840.10008.1.2.4.91	SCU	None
Ultrasound Image Storage	1.2.840.10008.5.1.4.1.1.6.1	JPEG 2000 Lossy	1.2.840.10008.1.2.4.91	SCU	None
Ultrasound Image Storage (retired)	1.2.840.10008.5.1.4.1.1.6	JPEG 2000 Lossy	1.2.840.10008.1.2.4.91	SCU	None
Ultrasound Multi-frame Image Storage	1.2.840.10008.5.1.4.1.1.3.1	JPEG 2000 Lossless	1.2.840.10008.1.2.4.90	SCU	None
Enhanced US Volume Storage	1.2.840.10008.5.1.4.1.1.6.2	JPEG 2000 Lossless	1.2.840.10008.1.2.4.90	SCU	None
Ultrasound Multi-frame Image Storage (retired)	1.2.840.10008.5.1.4.1.1.3	JPEG 2000 Lossless	1.2.840.10008.1.2.4.90	SCU	None
Presentation Context Table: Still Compression set to JPEG 2000 Lossless, Clip/Volume Compression set to None					
Secondary Capture Image Storage	1.2.840.10008.5.1.4.1.1.7	JPEG 2000 Lossless	1.2.840.10008.1.2.4.90	SCU	None
Ultrasound Image Storage	1.2.840.10008.5.1.4.1.1.6.1	JPEG 2000 Lossless	1.2.840.10008.1.2.4.90	SCU	None
Ultrasound Image Storage (retired)	1.2.840.10008.5.1.4.1.1.6	JPEG 2000 Lossless	1.2.840.10008.1.2.4.90	SCU	None
Ultrasound Multi-frame Image Storage	1.2.840.10008.5.1.4.1.1.3.1	Explicit VR Little Endian Explicit VR Big Endian Implicit VR Little Endian	1.2.840.10008.1.2.1 1.2.840.10008.1.2.2 1.2.840.10008.1.2	SCU	None
Enhanced US Volume Storage	1.2.840.10008.5.1.4.1.1.6.2	Explicit VR Little Endian Explicit VR Big Endian Implicit VR Little Endian	1.2.840.10008.1.2.1 1.2.840.10008.1.2.2 1.2.840.10008.1.2	SCU	None
Ultrasound Multi-frame Image Storage (retired)	1.2.840.10008.5.1.4.1.1.3	Explicit VR Little Endian Explicit VR Big Endian Implicit VR Little Endian	1.2.840.10008.1.2.1 1.2.840.10008.1.2.2 1.2.840.10008.1.2	SCU	None

Presentation Context Table: Still Compression set to JPEG 2000 Lossless, Clip/Volume Compression set to RLE					
Secondary Capture Image Storage	1.2.840.10008.5.1.4.1.1.7	JPEG 2000 Lossless	1.2.840.10008.1.2.4.90	SCU	None
Ultrasound Image Storage	1.2.840.10008.5.1.4.1.1.6.1	JPEG 2000 Lossless	1.2.840.10008.1.2.4.90	SCU	None
Ultrasound Image Storage (retired)	1.2.840.10008.5.1.4.1.1.6	JPEG 2000 Lossless	1.2.840.10008.1.2.4.90	SCU	None
Ultrasound Multi-frame Image Storage	1.2.840.10008.5.1.4.1.1.3.1	Run Length Encoding	1.2.840.10008.1.2.5	SCU	None
Enhanced US Volume Storage	1.2.840.10008.5.1.4.1.1.6.2	Run Length Encoding	1.2.840.10008.1.2.5	SCU	None
Ultrasound Multi-frame Image Storage (retired)	1.2.840.10008.5.1.4.1.1.3	Run Length Encoding	1.2.840.10008.1.2.5	SCU	None
Presentation Context Table: Still Compression set to JPEG 2000 Lossless, Clip/Volume Compression set to JPEG Lossy					
Secondary Capture Image Storage	1.2.840.10008.5.1.4.1.1.7	JPEG 2000 Lossless	1.2.840.10008.1.2.4.90	SCU	None
Ultrasound Image Storage	1.2.840.10008.5.1.4.1.1.6.1	JPEG 2000 Lossless	1.2.840.10008.1.2.4.90	SCU	None
Ultrasound Image Storage (retired)	1.2.840.10008.5.1.4.1.1.6	JPEG 2000 Lossless	1.2.840.10008.1.2.4.90	SCU	None
Ultrasound Multi-frame Image Storage	1.2.840.10008.5.1.4.1.1.3.1	JPEG Baseline	1.2.840.10008.1.2.4.50	SCU	None
Enhanced US Volume Storage	1.2.840.10008.5.1.4.1.1.6.2	JPEG Baseline	1.2.840.10008.1.2.4.50	SCU	None
Ultrasound Multi-frame Image Storage (retired)	1.2.840.10008.5.1.4.1.1.3	JPEG Baseline	1.2.840.10008.1.2.4.50	SCU	None
Presentation Context Table: Still Compression set to JPEG 2000 Lossless, Clip/Volume Compression set to JPEG Lossless					
Secondary Capture Image Storage	1.2.840.10008.5.1.4.1.1.7	JPEG 2000 Lossless	1.2.840.10008.1.2.4.90	SCU	None
Ultrasound Image Storage	1.2.840.10008.5.1.4.1.1.6.1	JPEG 2000 Lossless	1.2.840.10008.1.2.4.90	SCU	None
Ultrasound Image Storage (retired)	1.2.840.10008.5.1.4.1.1.6	JPEG 2000 Lossless	1.2.840.10008.1.2.4.90	SCU	None
Ultrasound Multi-frame Image Storage	1.2.840.10008.5.1.4.1.1.3.1	JPEG Lossless Non Hierarchical (Proc 14)	1.2.840.10008.1.2.4.70	SCU	None
Enhanced US Volume Storage	1.2.840.10008.5.1.4.1.1.6.2	JPEG Lossless Non Hierarchical (Proc 14)	1.2.840.10008.1.2.4.70	SCU	None
Ultrasound Multi-frame Image Storage (retired)	1.2.840.10008.5.1.4.1.1.3	JPEG Lossless Non Hierarchical (Proc 14)	1.2.840.10008.1.2.4.70	SCU	None
Presentation Context Table: Still Compression set to JPEG 2000 Lossless, Clip/Volume Compression set to JPEG 2000 Lossy					
Secondary Capture Image Storage	1.2.840.10008.5.1.4.1.1.7	JPEG 2000 Lossless	1.2.840.10008.1.2.4.90	SCU	None
Ultrasound Image Storage	1.2.840.10008.5.1.4.1.1.6.1	JPEG 2000 Lossless	1.2.840.10008.1.2.4.90	SCU	None
Ultrasound Image Storage (retired)	1.2.840.10008.5.1.4.1.1.6	JPEG 2000 Lossless	1.2.840.10008.1.2.4.90	SCU	None
Ultrasound Multi-frame Image Storage	1.2.840.10008.5.1.4.1.1.3.1	JPEG 2000 Lossy	1.2.840.10008.1.2.4.91	SCU	None
Enhanced US Volume Storage	1.2.840.10008.5.1.4.1.1.6.2	JPEG 2000 Lossy	1.2.840.10008.1.2.4.91	SCU	None
Ultrasound Multi-frame Image Storage	1.2.840.10008.5.1.4.1.1.3	JPEG 2000 Lossy	1.2.840.10008.1.2.4.91	SCU	None

(retired)					
Presentation Context Table for Structured Reports					
Comprehensive Structured Report	1.2.840.10008.5.1.4.1.1.88.33	Explicit VR Little Endian Implicit VR Little Endian	1.2.840.10008.1.2.1 1.2.840.10008.1.2	SCU	None
Presentation Context Table for Key Object Selection Document					
Key Object Selection Document	1.2.840.10008.5.1.4.1.1.88.59	Explicit VR Little Endian Implicit VR Little Endian	1.2.840.10008.1.2.1 1.2.840.10008.1.2	SCU	None

This operation also sends a Storage Commitment Request, with the following proposed presentation context. The result from the SCP is expected on another association for the Storage Commitment result.

Presentation Context Table Proposed					
Abstract Syntax		Transfer Syntax		Role	Extended Negotiation
Name	UID	Name List	UID List		
Storage Commitment Push Model SOP Class	1.2.840.10008.1.20.1	Explicit VR Little Endian Implicit VR Little Endian	1.2.840.10008.1.2.1 1.2.840.10008.1.2	SCU	None

2.3.1.2.1.2.1 SOP Specific Conformance Statement for Image Storage SOP Classes

For these SOP class all status codes with status Refused or Error are treated as failures and terminate the association and operation. On a failure, the request will be put in a holding queue for the user to manually retry the request. All status codes with status Warning or Success are treated as successes.

Service Status	Further Meaning	Status Codes	Application Behavior When receiving Status Codes
Failure	Refused: Out of Resources	A7xx	Terminate association. Mark the job failed.
	Error: Data Set does not match SOP Class	A9xx	
	Error: Cannot understand	Cxxx	
Warning	Coercion of Data Elements	B000	Treat the job success.
	Data Set does not match SOP Class	B007	
	Elements Discarded	B006	
Success		0000	
*	Any other status code	*	Terminate association. Mark the job failed.

C-STORE SCU operation supports an “Association Timer” and “Operation Inactivity Timer” with default time out value of 30 seconds each. Operation Inactivity Timer is configurable and different values that can be assigned to it are 1, 2, 3, 4, 5, 10, 20, 30, 60, 120 and 360 seconds.

2.3.1.2.2 Real-World Activity - ‘Echo’ Operation

2.3.1.2.2.1 Associated Real-World Activity

The user may initiate a DICOM Verification Request in the config screen.

Associations will be released upon the receipt of each C-ECHO confirmation.

2.3.1.2.2.2 Proposed Presentation Context Table

Presentation Context Table - Proposed					
Abstract Syntax		Transfer Syntax		Role	Extended Negotiation
Name	UID	Name List	UID List		
Verification SOP Class	1.2.840.10008.1.1	Explicit VR Little Endian	1.2.840.10008.1.2.1	SCU	None
		Implicit VR Little Endian	1.2.840.10008.1.2		

2.3.1.2.2.2.1 SOP Specific DICOM Conformance Statement for Verify SOP Class

The AE provides standard conformance to the Verification SOP Class as an SCU. In the event that the SCP does not respond for some reason, the operation will time out and LOGIQ E8 will close the association.

C-ECHO SCU operation supports an “Association Timer” and “Operation Inactivity Timer” with default time out value of 30 seconds and 10secs each. Operation Inactivity Timer is configurable and different values that can be assigned to it are 1 to 10 seconds.

2.3.1.2.3 Real-World Activity - ‘Worklist Query’ Operation

2.3.1.2.3.1 Associated Real-World Activity

The user may initiate a DICOM Worklist Query in Search screen, which will send a C-FIND-RQ to the Worklist SCP. Associations will be released upon the receipt of C-FIND-RSP confirmation.

2.3.1.2.3.2 Proposed Presentation Context Tables

Presentation Context Table – Proposed					
Abstract Syntax		Transfer Syntax		Role	Extended Negotiation
Name	UID	Name List	UID List		
Modality Worklist Information Model – FIND	1.2.840.10008.5.1.4.31	Explicit VR Little Endian	1.2.840.10008.1.2.1	SCU	None
		Implicit VR Little Endian	1.2.840.10008.1.2		

2.3.1.2.3.2.1 SOP Specific DICOM Conformance Statement for Worklist SOP Classes

The LOGIQ E8 includes matching keys in the Modality Worklist queries as described in Section 10. All status codes with status Refused or Error are treated as failures and terminate the association and operation. On a failure, the user will be informed and the last successful query will be used as Worklist. All status codes with status Warning or Success are treated as successes. Application doesn’t support C-FIND-CANCEL request.

Service Status	Status Code	Further Meaning	Application Behavior When receiving Status Codes
Refused	A700	Out of resources	Terminate the association and operation
	0122	SOP Class not Supported	
Failed	A900	Identifier does not match SOP Class	
	Cxxx	Unable to process	

Success	0000	Matching is complete – No final identifier is supplied	
Pending	FF00	Matches are continuing – Current Match is supplied and any Optional Keys were supported in the same manner	Receiving process of the matches continues.
	FF01	Matches are continuing – Warning that one or more Optional Keys were not supported for existence for this Identifier	
*	*	Any other status code.	Terminate the association and operation

Worklist operation supports an “Association Timer” and “Operation Inactivity Timer” with default time out value of 30 seconds each. Operation Inactivity Timer is configurable and different values that can be assigned to it are 1, 2, 3, 4, 5, 10, 20, 30, 60, 120 and 360 seconds.

2.3.1.2.4 Real-World Activity - ‘Image Store/End exam’ Operation

2.3.1.2.4.1 Associated Real-World Activity

The Modality Performed Procedure Step messages are sent when the first image is acquired for the start of an exam and when the exam is ended (for the case where there are no images, the N-CREATE is sent when the exam is ended). For an exam with saved images or results, the N-SET will be sent with status COMPLETED. For an exam without saved images or results, the N-SET will be sent with status DISCONTINUED.

2.3.1.2.4.2 Proposed Presentation Context Table

Presentation Context Table – Proposed					
Abstract Syntax		Transfer Syntax		Role	Extended Negotiation
Name	UID	Name List	UID List		
Modality Performed Procedure Step SOP Class	1.2.840.10008.3.1.2.3.3	Explicit VR Little Endian Implicit VR Little Endian	1.2.840.10008.1.2.1 1.2.840.10008.1.2	SCU	None

2.3.1.2.4.2.1 SOP Specific DICOM Conformance Statement for Modality Performed Procedure Step Class

LOGIQ E8 includes attributes in the Modality Performed Procedure Step N-CREATE and N-SET as described in Section 10.2.

LOGIQ E8 includes attributes in the Modality Performed Procedure Step N-SET as described in Section 11. The mapping from Worklist attributes is described in Section 10.5. LOGIQ E8 sends N-SET after the exam is ended. The N-SET will include all acquired images’ UIDs and the status of COMPLETED or DISCONTINUED.

For this SOP class, all status codes with status Refused or Error are treated as failures and terminate the association and operation. All status codes with status Warning or Success are treated as successes.

Modality Performed Procedure Step N-CREATE response status Handling Behavior

Service Status	Status Code	Further Meaning	Application Behavior When receiving Status Codes
Success	0000	Success	
*	*	Any other status	Treat as failure. Aborts the association.

Modality Performed Procedure Step N-SET response status Handling Behavior

Service Status	Status Code	Further Meaning	Application Behavior When receiving Status Codes
Failure	0110H	Processing Failure. Performed Procedure Step Object may no longer be updated	Aborts the operation.
Success	0000	Success	Completes the operation.
*	*	Any other status	Aborts the operation.

MPPS operation supports an “Association Timer” and “Operation Inactivity Timer” with default time out value of 30 seconds each. Operation Inactivity Timer is configurable and different values that can be assigned to it are 1, 2, 3, 4, 5, 10, 20, 30, 60, 120 and 360 seconds.

2.3.1.2.5 Real-World Activity - ‘Image Print’ Operation

2.3.1.2.5.1 Associated Real-World Activity

Upon a request by the operator, print jobs will be sent to a DICOM Print SCP. If an error occurs during the transmission, the current association is released and a new association initiated. The maximum number of retries is configurable.

2.3.1.2.5.2 Proposed Presentation Context Tables

The following table is used:

Presentation Context Table - Proposed					
Abstract Syntax		Transfer Syntax		Role	Extended Negotiation
Name	UID	Name List	UID List		
Basic Grayscale Print Management Meta SOP Class	1.2.840.10008.5.1.1.9	Explicit VR Little Endian Implicit VR Little Endian	1.2.840.10008.1.2.1 1.2.840.10008.1.2	SCU	None
Basic Color Print Management Meta SOP Class	1.2.840.10008.5.1.1.18	Explicit VR Little Endian Implicit VR Little Endian	1.2.840.10008.1.2.1 1.2.840.10008.1.2	SCU	None
Basic Annotation Box SOP Class	1.2.840.10008.5.1.1.15	Explicit VR Little Endian Implicit VR Little Endian	1.2.840.10008.1.2.1 1.2.840.10008.1.2	SCU	None

2.3.1.2.5.2.1 SOP Specific DICOM Conformance Statement for all Print Management SOP Classes

All status codes with status Refused or Error are treated as failures and terminate the association and operation. All status codes with status Warning or Success are treated as successes.

Services supported for each Print Meta SOP Classes

SOP Class	SOP Class UID	DIMSE Service Element	SCU Usage
Basic Film Session	1.2.840.10008.5.1.1.1	N-CREATE	Used
		N-SET	Not Used
		N-DELETE	Not Used
		N-ACTION	Not Used
Basic Film Box	1.2.840.10008.5.1.1.2	N-CREATE	Used
		N-ACTION	Used
		N-DELETE	Used
		N-SET	Not Used
Printer	1.2.840.10008.5.1.1.16	N-EVENT-REPORT	Not Used
		N-GET	Used
Basic Grayscale Image Box	1.2.840.10008.5.1.1.4	N-SET	Used
Basic Color Image Box	1.2.840.10008.5.1.1.4.1	N-SET	Used
Basic Annotation Box	1.2.840.10008.5.1.1.15	N-SET	Used

DICOM Print response status Handling Behavior

Service Status	Status Code	Further Meaning	Application Behavior When receiving Status Codes
Success	0000	Success	
Warning	B600	Warning	Treated as success with warning log.
*	*	Any other status	Treated as failure. Aborts the association.

Dicom Print operation supports an “Association Timer” and “Operation Inactivity Timer” with default time out value of 30 seconds each. Operation Inactivity Timer is configurable and different values that can be assigned to it are 1, 2, 3, 4, 5, 10, 20, 30, 60, 120 and 360 seconds.

2.3.1.2.6 Real-World Activity - ‘Exam Query/Retrieve’ Operation

2.3.1.2.6.1 Associated Real-World Activity

The user may initiate a DICOM Exam Query in Search screen, which will send a C-FIND-RQ to the Query/Retrieve SCP. Associations will be released upon the receipt of C-FIND-RSP confirmation.

The user may then select an examination to be retrieved, using the C-MOVE-RQ command to the Query/Retrieve SCP. The result from the SCP is expected on another association for the retrieved examinations.

2.3.1.2.6.2 Proposed Presentation Context Tables

Presentation Context Table – Proposed			
Abstract Syntax	Transfer Syntax	Role	Extended

Name	UID	Name List	UID List		Negotiation
Study Root Query/Retrieve Information Model - FIND	1.2.840.10008.5.1.4.1.2.2.1	Explicit VR Little Endian Implicit VR Little Endian	1.2.840.10008.1.2.1 1.2.840.10008.1.2	SCU	None
Study Root Query/Retrieve Information Model - MOVE	1.2.840.10008.5.1.4.1.2.2.2	Explicit VR Little Endian Implicit VR Little Endian	1.2.840.10008.1.2.1 1.2.840.10008.1.2	SCU	None

2.3.1.2.6.2.1 SOP Specific DICOM Conformance Statement for Study Root Query/Retrieve Information Model - FIND SOP Classes

Only a single information model, Study Root, is supported.

All queries are initiated at the highest level of the information model (the STUDY level), and then for each response received, recursively repeated at the next lower levels (the SERIES and then IMAGE levels).

C-FIND-CANCEL request is not supported.

All status codes with status Refused or Error are treated as failures and terminate the association and operation. All status codes with status Warning or Success are treated as successes. LOGIQ E8 will only support hierarchical query.

Service Status	Status Code	Further Meaning	Application Behavior When Receiving Status Code
Failure	A700	Refused: Out of resources	Operation aborted.
	A900	Error: Identifier does not match SOP Class	
	C000-CFFF	Error: Unable to process	
	0122	SOP Class Not Supported	
Cancel	FE00	Matching terminated due to cancel	Display the results in UI.
Success	0000	Matching is complete - No final identifier is supplied	Display the results in UI.
Pending	FF00	Matches are continuing - Current Match is supplied and any Optional Keys were supported in the same manner as Required Keys.	Stores the results internally and waits for the more results.
	FF01	Matches are continuing - Warning that one or more Optional Keys were not supported for existence and/or matching for this Identifier	
*	*	Any other status code.	Operation aborted.

GE Healthcare

DIR DOC1585895 REV 2

C-FIND SCU operation supports an “Association Timer” and “Operation Inactivity Timer” with default time out value of 30 seconds each. Operation Inactivity Timer is configurable and different values that can be assigned to it are 1, 2, 3, 4, 5, 10, 20, 30, 60, 120 and 360 seconds.

LOGIQ E8 query responses for Key Object Selection documents and Structured Report documents.

Study Level attributes for the Study Root Query/Retrieve Information Model is described in Section 15.2.

Types of Matching:

- Single Value matching (S)
- Universal Matching (U)
- Wild Card Matching (*)
- Range of date, Range of Time (R)

The types of Matching supported by the C-FIND SCU are: ‘S’ indicates the identifier attribute uses Single Value Matching, an ‘R’ indicates Range Matching, a “*” indicates wildcard matching, a ‘U’ indicates Universal Matching, and ‘UNIQUE’ indicates that this is the Unique Key for that query level, in which case Universal Matching or Single Value Matching is used depending on the query level.

“Filtering is supported” means that matching strings can be controlled from the Search screen at Data Transfer. All other matching fields can be configured in Config screen to be either enabled, enabled with a matching string value or disabled. The constant value will be used as entered by user.

2.3.1.2.6.2.2 SOP Specific DICOM Conformance Statement for Study Root Query/Retrieve Information Model - MOVE SOP Classes

All status codes with status Refused or Error are treated as failures and terminate the association and operation. All status codes with status Warning or Success are treated as successes.

C-MOVE-CANCEL request is not supported.

Service Status	Status Code	Further Meaning	Application Behavior When Receiving Status Code
Failure	A701	Refused: Out of resources - Unable to calculate number of matches	Retrieve operation will be aborted.
	A702	Refused: Out of resources - Unable to perform sub-operations	
	A801	Refused: Move Destination Unknown	
	A900	Error: Identifier does not match SOP Class	
	C000-CFFF	Error: Unable to process	
	0122	SOP Class Not Supported	

Cancel	FE00	Sub-operations terminated due to a Cancel indication	
Warning	B000	Sub-operations Complete - One or more Failures.	Imports selected patient(s).
Success	0000	Sub-operations Complete - No Failure.	
Pending	FF00	Sub-operations are continuing -	Stores the patients internally until final response.
*	*	Any other status code.	Retrieve operation will be aborted.

C-MOVE SCU operation supports an “Association Timer” and “Operation Inactivity Timer” with default time out value of 30 seconds each. Operation Inactivity Timer is configurable and different values that can be assigned to it are 1, 2, 3, 4, 5, 10, 20, 30, 60, 120 and 360 seconds.

2.3.1.3 Association Acceptance Policy

The AE accepts an association when it receives a Verification Request from another network device or a store request from a Q/R SCP or a Storage Commitment result from a Storage Commitment SCP.

2.3.1.3.1 Real-World Activity - ‘Echo’ operation

2.3.1.3.1.1 Associated Real-World Activity

An incoming Verification Request will cause the AE to accept the association and respond with a Verification Response.

2.3.1.3.1.2 Accepted Presentation Context Table

Presentation Context Table - Accepted					
Abstract Syntax		Transfer Syntax		Role	Extended
Name	UID	Name List	UID List		Negotiation
Verification SOP Class	1.2.840.10008.1.1	Explicit VR Little Endian Implicit VR Little Endian	1.2.840.10008.1.2.1 1.2.840.10008.1.2	SCP	None

2.3.1.3.1.2.1 SOP Specific DICOM Conformance Statement for Verify SOP Class

The AE provides standard conformance to the Verification SOP Class as an SCP. The port number used is configured on config screen, default is 104.

2.3.1.3.1.3 Presentation Context Acceptance Criterion

No criterion.

2.3.1.3.1.4 Transfer Syntax Selection Policies

The selected transfer syntax is based on the proposed transfer syntax list. The priority order is Explicit VR Little Endian and Implicit VR Little Endian.

2.3.1.3.2 Real-World Activity - 'Exam Query/Retrieve' Operation

2.3.1.3.2.1 Associated Real-World Activity

If the user has initiated a retrieve by a C-MOVE-RQ, the AE will accept associations for C-STORE-RQs. The images will be stored locally.

2.3.1.3.2.2 Accepted Presentation Context Table

Abstract Syntax		Transfer Syntax		Role	Extended Negotiation
Name	UID	Name List	UID List		
Ultrasound Image Storage	1.2.840.10008.5.1.4.1.1.6.1	JPEG 2000 Lossless JPEG 2000 Lossy JPEG Baseline JPEG Lossless Non Hierarchical (Proc 14) Run Length Encoding Exp VR Little Endian Explicit VR Big Endian Imp VR Little Endian	1.2.840.10008.1.2.4.90 1.2.840.10008.1.2.4.91 1.2.840.10008.1.2.4.50 1.2.840.10008.1.2.4.70 1.2.840.10008.1.2.5 1.2.840.10008.1.2.1 1.2.840.10008.1.2.2 1.2.840.10008.1.2	SCP	None
Ultrasound Multi-frame Image Storage	1.2.840.10008.5.1.4.1.1.3.1	JPEG 2000 Lossless JPEG 2000 Lossy JPEG Baseline JPEG Lossless Non Hierarchical (Proc 14) Run Length Encoding Exp VR Little Endian Explicit VR Big Endian Imp VR Little Endian	1.2.840.10008.1.2.4.90 1.2.840.10008.1.2.4.91 1.2.840.10008.1.2.4.50 1.2.840.10008.1.2.4.70 1.2.840.10008.1.2.5 1.2.840.10008.1.2.1 1.2.840.10008.1.2.2 1.2.840.10008.1.2	SCP	None
Enhanced US Volume Storage	1.2.840.10008.5.1.4.1.1.6.2	JPEG 2000 Lossless JPEG 2000 Lossy JPEG Baseline JPEG Lossless Non Hierarchical (Proc 14) Run Length Encoding Exp VR Little Endian Explicit VR Big Endian Imp VR Little Endian	1.2.840.10008.1.2.4.90 1.2.840.10008.1.2.4.91 1.2.840.10008.1.2.4.50 1.2.840.10008.1.2.4.70 1.2.840.10008.1.2.5 1.2.840.10008.1.2.1 1.2.840.10008.1.2.2 1.2.840.10008.1.2	SCP	None
Ultrasound Image Storage (retired)	1.2.840.10008.5.1.4.1.1.6	JPEG 2000 Lossless JPEG 2000 Lossy JPEG Baseline JPEG Lossless Non Hierarchical (Proc 14) Run Length Encoding Exp VR Little Endian Explicit VR Big Endian Imp VR Little Endian	1.2.840.10008.1.2.4.90 1.2.840.10008.1.2.4.91 1.2.840.10008.1.2.4.50 1.2.840.10008.1.2.4.70 1.2.840.10008.1.2.5 1.2.840.10008.1.2.1 1.2.840.10008.1.2.2 1.2.840.10008.1.2	SCP	None
Ultrasound Multi-frame Image Storage (retired)	1.2.840.10008.5.1.4.1.1.3	JPEG 2000 Lossless JPEG 2000 Lossy JPEG Baseline JPEG Lossless Non Hierarchical (Proc 14) Run Length Encoding Exp VR Little Endian Explicit VR Big Endian Imp VR Little Endian	1.2.840.10008.1.2.4.90 1.2.840.10008.1.2.4.91 1.2.840.10008.1.2.4.50 1.2.840.10008.1.2.4.70 1.2.840.10008.1.2.5 1.2.840.10008.1.2.1 1.2.840.10008.1.2.2 1.2.840.10008.1.2	SCP	None

Secondary Capture Image Storage	1.2.840.10008.5.1.4.1.1.7	JPEG 2000 Lossless JPEG 2000 Lossy JPEG Baseline JPEG Lossless Non Hierarchical (Proc 14) Run Length Encoding Exp VR Little Endian Explicit VR Big Endian Imp VR Little Endian	1.2.840.10008.1.2.4.90 1.2.840.10008.1.2.4.91 1.2.840.10008.1.2.4.50 1.2.840.10008.1.2.4.70 1.2.840.10008.1.2.5 1.2.840.10008.1.2.1 1.2.840.10008.1.2.2 1.2.840.10008.1.2	SCP	None
CT Image Storage	1.2.840.10008.5.1.4.1.1.2	Exp VR Little Endian Explicit VR Big Endian Imp VR Little Endian	1.2.840.10008.1.2.1 1.2.840.10008.1.2.2 1.2.840.10008.1.2	SCP	None
MR Image Storage	1.2.840.10008.5.1.4.1.1.4	Exp VR Little Endian Explicit VR Big Endian Imp VR Little Endian	1.2.840.10008.1.2.1 1.2.840.10008.1.2.2 1.2.840.10008.1.2	SCP	None
Digital Mammography Storage For Presentation	1.2.840.10008.5.1.4.1.1.2	Exp VR Little Endian Explicit VR Big Endian Imp VR Little Endian	1.2.840.10008.1.2.1 1.2.840.10008.1.2.2 1.2.840.10008.1.2	SCP	None
Digital Mammography Storage For Processing	1.2.840.10008.5.1.4.1.1.2.1	Exp VR Little Endian Explicit VR Big Endian Imp VR Little Endian	1.2.840.10008.1.2.1 1.2.840.10008.1.2.2 1.2.840.10008.1.2	SCP	None
Positron Emission Tomography Image Storage	1.2.840.10008.5.1.4.1.1.128	Exp VR Little Endian Explicit VR Big Endian Imp VR Little Endian	1.2.840.10008.1.2.1 1.2.840.10008.1.2.2 1.2.840.10008.1.2	SCP	None

2.3.1.3.2.2.1 SOP Specific DICOM Conformance Statement for Storage SOP Classes

The AE provides standard conformance to the Storage SOP Classes as an SCP. The port number used is 104. Below are all possible status codes which LOGIQ E8 would send upon storage request.

Application doesn't support extended negotiation hence the Storage Level is set to Level 2.

Service Status	Status Code	Conditions
Failed	C000	Processing Error
Success	0000	SOP Instance is stored successfully.

The system currently supports retrieval of Enhanced US Volume dataset if the dataset is generated by LOGIQ E8 scanner and the LOGIQ E8 generated volume raw data is present.

2.3.1.3.2.3 Presentation Context Acceptance Criterion

No criterion.

2.3.1.3.2.4 Transfer Syntax Selection Policies

The selected transfer syntax is based on the proposed transfer syntax list.

The priority order in case of Ultrasound Image Storage, Ultrasound Multi-frame Image Storage, Ultrasound Image Storage (retired), Ultrasound Multi-frame Image Storage (retired), Enhanced US Volume Storage and Secondary Capture Image Storage is JPEG2000 Lossless, JPEG2000 Lossy, JPEG Lossless Non Hierarchical, JPEG Baseline, Run Length Encoding (RLE), Explicit VR Little Endian, Explicit VR Big Endian and Implicit VR Little Endian.

The priority order in case of CT Image Storage, MR Image Storage, Digital Mammography Storage For Presentation, Digital Mammography Storage For Processing and Positron Emission Tomography Image Storage is Explicit VR Little Endian, Explicit VR Big Endian and Implicit VR Little Endian.

2.3.1.3.3 Real-World Activity - 'Exam save' Operation

GE Healthcare

DIR DOC1585895 REV 2

2.3.1.3.3.1 Associated Real-World Activity

LOGIQ E8 will only listen for an N-EVENT-REPORT (Storage Commitment Result) from a Storage Commitment SCP in a new association.

2.3.1.3.3.2 Proposed Presentation Context Tables

The Proposed Presentation Context Table depends on compression according to the following table:

Presentation Context Table – Proposed					
Abstract Syntax		Transfer Syntax		Role	Extended
Name	UID	Name List	UID List		Negotiation
Storage Commitment Push Model SOP Class	1.2.840.10008.1.20.1	Explicit VR Little Endian Implicit VR Little Endian	1.2.840.10008.1.2.1 1.2.840.10008.1.2	SCU	None

2.3.1.3.3.2.1 SOP Specific DICOM Conformance Statement for the Storage Commitment Push Model SOP Class SCU

LOGIQ E8 will only accept the SCU role (which must be proposed via SCP/SCU Role Selection Negotiation) within a Presentation Context for the Storage Commitment Push Model SOP Class. The result from the SCP is expected on another association for the Storage Commitment result.

The LOGIQ E8 behavior after receiving an N-EVENT-REPORT (Storage Commitment Result) is described in Section 12.2.4. Below are all possible status codes which LOGIQ E8 would send upon N-EVENT-REPORT request as EVENT-REPORT response.

Service Status	Status Code	Conditions
Failed	0110H	Processing Error
Success	0000	N-Even Report received successfully.

2.4 COMMUNICATION PROFILES**2.4.1 Supported Communication Stacks (PS 3.8)**

DICOM Upper Layer (PS 3.8) is supported using TCP/IP.

2.4.2 TCP/IP Stack

The TCP/IP stack is inherited from the product's operating system. Please refer to product documentation for more information.

2.4.2.1 API

Not applicable to this product.

2.4.3 Additional Protocols

LOGIQ E8 R2 supports DHCP.

2.4.4 IPv4 and IPv6 support

LOGIQ E8 R2 supports IPv4 only.

DIR DOC1585895 REV 2

2.5 EXTENSIONS / SPECIALIZATIONS / PRIVATIZATIONS

If so configured, the product will send ultrasound raw data information in private data elements designated by the Private Creator element:

Element Name	Tag	VR	VM	Description
Private Creator	7FE1,00xx	LO	1	GEMS_Ultrasound_MovieGroup_001

This means that all private tags starting with 7FE1,xx will belong to the GEMS_Ultrasound_MovieGroup_001.

If so configured, the product will send preview image in private data elements designated by the Private Creator element:

Element Name	Tag	VR	VM	Description
Private Creator	6003,00xx	LO	1	GEMS_Ultrasound_ImageGroup_001

This means that all private tags starting with 6003,xx will belong to the GEMS_Ultrasound_ImageGroup_001.

The product will send measurements raw data information in private data elements designated by the Private Creator element:

Element Name	Tag	VR	VM	Description
Private Creator	6005,00xx	LO	1	GE_GROUP

This means that all private tags starting with 6005,xx will belong to the GE_GROUP.

2.6 CONFIGURATION**2.6.1 AE Title/Presentation Address Mapping**

The Local AE title is configurable through the Config screen, see below.

2.6.2 Configurable Parameters**Network:**

- Local IP address
- Local IP netmask
- Default Gateway
- Local network speed information

Local:

- Local AE Title
- Local port number

Verification:

- The AE Title, IP address and port number of the SCP
- Max retries, Retry interval, Timeout

Modality Worklist:

- The AE Title, IP address and port number of the SCP
- Max retries, Retry interval, Timeout
- Refresh interval - the interval between downloads from the worklist. Searching for a patient within the time of a refresh interval does not perform a new worklist query.
- Disabling/enabling and setting constant values for query fields – This is a way to disable search criteria in the worklist query or setting them to a fixed value.
- Maximum number of downloaded entries

Storage:

DIR DOC1585895 REV 2

- The AE Title, IP address and port number of the SCP
- Max retries, Retry interval, Timeout
- Enable/disable raw data
- Frame rate reduction
- Enable/disable multi-frame
- Compression selections
- Color support
- Association strategies: one association per image or one association per exam
- Include structured report (SR).
- Included Key Object Selection Document for Image Rejection (KOS)

Modality Performed Procedure Step:

- The AE Title, IP address and port number of the SCP
- Max retries, Retry interval, Timeout

Storage Commitment:

- The AE Title, IP address and port number of the SCP
- Max retries, Retry interval, Timeout
- The associated Storage service which triggers the sending of Storage Commitment requests

Print:

- The AE Title, IP address and port number of the SCP
- Max retries, Retry interval, Timeout
- Include Annotation Box
- Configuration for each job according to attribute description in Section 12 of this document.

Query/Retrieve:

- The AE Title, IP address and port number of the SCP
- Max retries, Retry interval, Timeout
- Disabling/enabling and setting constant values for query fields
- Maximum number of downloaded entries

2.7 SUPPORT OF EXTENDED CHARACTER SETS

LOGIQ E8 supports the ISO IR 100 (ISO 8859-1:1987 Latin alphabet N 1. supplementary set). Other character sets won't be displayed correctly if received.

2.8 CODES AND CONTROLLED TERMINOLOGY

2.8.1 Fixed Coded Terminology

The product uses the fixed (non-configurable, non-extensible) coded terminology in SR Document and Key Object Selection attributes, as described in Section: 8 and Section: 9.

2.9 SECURITY PROFILES

The product does not conform to any defined DICOM Security Profiles.

It is assumed that the product is used within a secured environment. It is assumed that a secured environment includes at a minimum:

1. Firewall or router protections to ensure that only approved external hosts have network access to the product.
2. Firewall or router protections to ensure that the product only has network access to approved external hosts and services.
3. Any communications with external hosts and services outside the locally secured environment use appropriate secure network channels (such as a Virtual Private Network (VPN))

3. MEDIA STORAGE CONFORMANCE STATEMENT

3.1 INTRODUCTION

This section of the conformance statement (CS) specifies the LOGIQ E8 compliance to DICOM Media Interchange. It details the DICOM Media Storage Application Profiles and roles, which are supported by this product. LOGIQ E8 is able to export images to DICOM media, browse DICOM media or read images from DICOM media. And this product doesn't support DICOM SR and KOS document objects.

3.2 IMPLEMENTATION MODEL

3.2.1 Application Data Flow Diagram

The Basic and Specific Application models for this device are shown in the following Illustration:

ILLUSTRATION 3-1
SPECIFIC AE APPLICATION MODEL

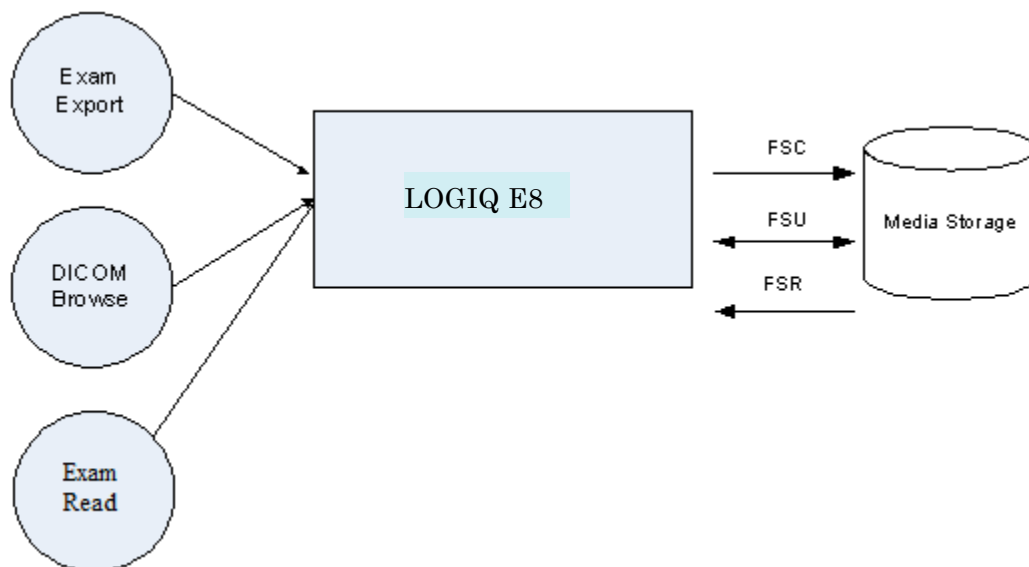

LOGIQ E8 can initialize Media by acting as an FSC to create a new DICOM File-set on CD/DVD media of various sizes. The SOP instances written to media must be one of the instances supported by LOGIQ E8. A pre-existing File-set will be updated with the information in DICOM files copied to media.

3.2.2 Functional Definition of AE's

LOGIQ E8 can perform these functions:

- Create a new DICOM File-set on media
- Update DICOM File-set by adding new SOP instances to the File-set
- Read information and images from the existing File-set

3.2.3 Sequencing Requirements

None applicable

3.2.4 File Meta Information Options (See PS3.10)

The File Meta-Information for this implementation is:

File Meta-Information Version	1
-------------------------------	---

LOGIQ E8 Implementation UID	1.2.840.113619.6.352
Implementation Version Name	LOGIQE8_1

Note: The Implementation Version Name and may change in the future without modification of this document.

3.3 AE SPECIFICATIONS

3.3.1 LOGIQ E8 AE Specification

The LOGIQ E8 Application Entity provides standard conformance to DICOM Interchange Option of the Media Storage Service Class. The Application Profiles and roles are listed below; the standard profiles are augmented with Secondary Capture images.

TABLE 3-1

Supported Application Profile	Real World Activity	Role	Description
STD-GEN-CD	Exam export	FSC/FSU	Interchange
	Browse	FSR	Interchange
	Exam Read	FSR	Interchange
STD-GEN-DVD-JPEG	Exam export	FSC/ FSU	Interchange
	Browse	FSR	Interchange
	Exam Read	FSR	Interchange
STD-GEN-DVD-J2K	Exam export	FSC/ FSU	Interchange
	Browse	FSR	Interchange
	Exam Read	FSR	Interchange
STD-GEN-USB-JPEG	Exam export	FSC/ FSU	Interchange
	Browse	FSR	Interchange
	Exam Read	FSR	Interchange
STD-GEN-USB-J2K	Exam export	FSC/ FSU	Interchange
	Browse	FSR	Interchange
	Exam Read	FSR	Interchange

3.3.1.1 File Meta Information for the LOGIQ E8 Application Entity

The Source Application Entity is set from the LOGIQ E8 local AE title. The local AE is configurable. Following are the default value set in the File Meta Information for this AE Title:

Source Application Entity Title	LOGIQE8-000000 (User Configurable)
--	---

3.3.1.2 Real-World Activities for the LOGIQ E8 Application Entity

3.3.1.2.1 Real-World Activity “Exam export”

“Exam export” saves a DICOM SOP instance to media and updates DICOM File Set.

DIR DOC1585895 REV 2

3.3.1.2.1.1 Media Storage Application Profile for the Real-World Activity “Exam export”:

For the list of Application Profiles that invoke this AE for “Exam export” Real-World Activity, see the Table in Section 3.3 “LOGIQ E8 AE Specification” where the table describing the profiles and real-world activities is defined.

3.3.1.2.1.1.1 Options

Following are the SOP Classes supported by the Real-World Activity “Exam export”:

TABLE 3-2

Information Object Definition	SOP Class UID	Transfer Syntax	Transfer Syntax UID
Ultrasound Image Storage	1.2.840.10008.5.1.4.1.1.6.1	JPEG 2000 Lossless JPEG 2000 Lossy JPEG Baseline JPEG Lossless Non Hierarchical (Proc 14) Run Length Encoding Exp VR Little Endian Explicit VR Big Endian Imp VR Little Endian	1.2.840.10008.1.2.4.90 1.2.840.10008.1.2.4.91 1.2.840.10008.1.2.4.50 1.2.840.10008.1.2.4.70 1.2.840.10008.1.2.5 1.2.840.10008.1.2.1 1.2.840.10008.1.2.2 1.2.840.10008.1.2
Ultrasound Multi-frame Image Storage	1.2.840.10008.5.1.4.1.1.3.1	JPEG 2000 Lossless JPEG 2000 Lossy JPEG Baseline JPEG Lossless Non Hierarchical (Proc 14) Run Length Encoding Exp VR Little Endian Explicit VR Big Endian Imp VR Little Endian	1.2.840.10008.1.2.4.90 1.2.840.10008.1.2.4.91 1.2.840.10008.1.2.4.50 1.2.840.10008.1.2.4.70 1.2.840.10008.1.2.5 1.2.840.10008.1.2.1 1.2.840.10008.1.2.2 1.2.840.10008.1.2
Enhanced US Volume Storage	1.2.840.10008.5.1.4.1.1.6.2	JPEG 2000 Lossless JPEG 2000 Lossy JPEG Baseline JPEG Lossless Non Hierarchical (Proc 14) Run Length Encoding Exp VR Little Endian Explicit VR Big Endian Imp VR Little Endian	1.2.840.10008.1.2.4.90 1.2.840.10008.1.2.4.91 1.2.840.10008.1.2.4.50 1.2.840.10008.1.2.4.70 1.2.840.10008.1.2.5 1.2.840.10008.1.2.1 1.2.840.10008.1.2.2 1.2.840.10008.1.2
Ultrasound Image Storage (retired)	1.2.840.10008.5.1.4.1.1.6	JPEG 2000 Lossless JPEG 2000 Lossy JPEG Baseline JPEG Lossless Non Hierarchical (Proc 14) Run Length Encoding Exp VR Little Endian Explicit VR Big Endian Imp VR Little Endian	1.2.840.10008.1.2.4.90 1.2.840.10008.1.2.4.91 1.2.840.10008.1.2.4.50 1.2.840.10008.1.2.4.70 1.2.840.10008.1.2.5 1.2.840.10008.1.2.1 1.2.840.10008.1.2.2 1.2.840.10008.1.2
Ultrasound Multi-frame Image Storage (retired)	1.2.840.10008.5.1.4.1.1.3	JPEG 2000 Lossless JPEG 2000 Lossy JPEG Baseline JPEG Lossless Non Hierarchical (Proc 14) Run Length Encoding Exp VR Little Endian Explicit VR Big Endian Imp VR Little Endian	1.2.840.10008.1.2.4.90 1.2.840.10008.1.2.4.91 1.2.840.10008.1.2.4.50 1.2.840.10008.1.2.4.70 1.2.840.10008.1.2.5 1.2.840.10008.1.2.1 1.2.840.10008.1.2.2 1.2.840.10008.1.2

Secondary Capture Image Storage	1.2.840.10008.5.1.4.1.1.7	JPEG 2000 Lossless JPEG 2000 Lossy JPEG Baseline JPEG Lossless Non Hierarchical (Proc 14) Run Length Encoding Exp VR Little Endian Explicit VR Big Endian Imp VR Little Endian	1.2.840.10008.1.2.4.90 1.2.840.10008.1.2.4.91 1.2.840.10008.1.2.4.50 1.2.840.10008.1.2.4.70 1.2.840.10008.1.2.5 1.2.840.10008.1.2.1 1.2.840.10008.1.2.2 1.2.840.10008.1.2
CT Image Storage	1.2.840.10008.5.1.4.1.1.2	Exp VR Little Endian Explicit VR Big Endian Imp VR Little Endian	1.2.840.10008.1.2.1 1.2.840.10008.1.2.2 1.2.840.10008.1.2
MR Image Storage	1.2.840.10008.5.1.4.1.1.4	Exp VR Little Endian Explicit VR Big Endian Imp VR Little Endian	1.2.840.10008.1.2.1 1.2.840.10008.1.2.2 1.2.840.10008.1.2
Digital Mammography Storage For Presentation	1.2.840.10008.5.1.4.1.1.1.2	Exp VR Little Endian Explicit VR Big Endian Imp VR Little Endian	1.2.840.10008.1.2.1 1.2.840.10008.1.2.2 1.2.840.10008.1.2
Digital Mammography Storage For Processing	1.2.840.10008.5.1.4.1.1.1.2.1	Exp VR Little Endian Explicit VR Big Endian Imp VR Little Endian	1.2.840.10008.1.2.1 1.2.840.10008.1.2.2 1.2.840.10008.1.2
Positron Emission Tomography Image Storage	1.2.840.10008.5.1.4.1.1.128	Exp VR Little Endian Explicit VR Big Endian Imp VR Little Endian	1.2.840.10008.1.2.1 1.2.840.10008.1.2.2 1.2.840.10008.1.2

3.3.1.2.2 Real-World Activity “DICOM Browse”

DICOM Browse is activated when the user searches for an exam in Search screen.

3.3.1.2.2.1 Media Storage Application Profile for the Real-World Activity “DICOM Browse”

For the list of Application Profiles that invoke this AE for Image Read Real-World Activity, see the Table in Section 3.3.1 “LOGIQ E8 AE Specification”.

3.3.1.2.2.1.1 Options

Following are the SOP Classes supported by the Real-World Activity DICOM Browse:

TABLE 3-3

Information Object Definition	SOP Class UID	Transfer Syntax	Transfer Syntax UID
Media Storage Directory Storage	1.2.840.10008.1.3.10	Explicit VR Little Endian	1.2.840.10008.1.2.1

3.3.1.2.3 Real-World Activity “Exam read“

“Exam read” reads and displays a DICOM SOP instance from media.

3.3.1.2.3.1 Media Storage Application Profile for the Real-World Activity “Exam read “

For the list of Application Profiles that invoke this AE for Exam read Real-World Activity, see the Table in Section 3.3.1 “LOGIQ E8 AE Specification”.

3.3.1.2.3.1.1 Options

Following are the SOP Classes supported by the Exam read Real-World Activity:

TABLE 3-4

Information Object Definition	SOP Class UID	Transfer Syntax	Transfer Syntax UID
-------------------------------	---------------	-----------------	---------------------

Ultrasound Image Storage	1.2.840.10008.5.1.4.1.1.6.1	JPEG 2000 Lossless JPEG 2000 Lossy JPEG Baseline JPEG Lossless Non Hierarchical (Proc 14) Run Length Encoding Exp VR Little Endian Explicit VR Big Endian Imp VR Little Endian	1.2.840.10008.1.2.4.90 1.2.840.10008.1.2.4.91 1.2.840.10008.1.2.4.50 1.2.840.10008.1.2.4.70 1.2.840.10008.1.2.5 1.2.840.10008.1.2.1 1.2.840.10008.1.2.2 1.2.840.10008.1.2
Ultrasound Multi-frame Image Storage	1.2.840.10008.5.1.4.1.1.3.1	JPEG 2000 Lossless JPEG 2000 Lossy JPEG Baseline JPEG Lossless Non Hierarchical (Proc 14) Run Length Encoding Exp VR Little Endian Explicit VR Big Endian Imp VR Little Endian	1.2.840.10008.1.2.4.90 1.2.840.10008.1.2.4.91 1.2.840.10008.1.2.4.50 1.2.840.10008.1.2.4.70 1.2.840.10008.1.2.5 1.2.840.10008.1.2.1 1.2.840.10008.1.2.2 1.2.840.10008.1.2
Enhanced US Volume Storage	1.2.840.10008.5.1.4.1.1.6.2	JPEG 2000 Lossless JPEG 2000 Lossy JPEG Baseline JPEG Lossless Non Hierarchical (Proc 14) Run Length Encoding Exp VR Little Endian Explicit VR Big Endian Imp VR Little Endian	1.2.840.10008.1.2.4.90 1.2.840.10008.1.2.4.91 1.2.840.10008.1.2.4.50 1.2.840.10008.1.2.4.70 1.2.840.10008.1.2.5 1.2.840.10008.1.2.1 1.2.840.10008.1.2.2 1.2.840.10008.1.2

3.4 AUGMENTED AND PRIVATE APPLICATION PROFILES

3.4.1 Roles and Service Class Options

3.4.1.1 File Set Creator

File Set Creator shall be able to generate the Basic Directory SOP Class in the DICOMDIR File with all types of Directory Records related to the SOP Classes stored in the File-set.

3.4.1.2 File Set Reader

File Set Readers shall be able to read all the SOP Classes defined for the specific Application Profile for which a Conformance Statement is made using all the defined Transfer Syntaxes.

3.4.2 Augmented Application Profiles

The CD-R, DVD and USB Media Archive Interchange AE does not support any augmented Application Profiles.

3.4.3 Private Application Profiles

The CD-R, DVD and USB Media Interchange AE does not support any private Application Profiles.

3.5 EXTENSIONS, SPECIALIZATIONS, PRIVATIZATIONS OF SOP CLASSES AND TRANSFER SYNTAXES

If so configured, the product will send ultrasound raw data information in private data elements designated by the Private Creator element:

Element Name	Tag	VR	VM	Description
--------------	-----	----	----	-------------

DIR DOC1585895 REV 2

Private Creator	7FE1,00xx	LO	1	GEMS_Ultrasound_MovieGroup_001
-----------------	-----------	----	---	--------------------------------

This means that all private tags starting with 7FE1,xx will belong to the GEMS_Ultrasound_MovieGroup_001.

If so configured, the product will send ultrasound preview image in private data elements designated by the Private Creator element:

Element Name	Tag	VR	VM	Description
Private Creator	6003,00xx	LO	1	GEMS_Ultrasound_ImageGroup_001

This means that all private tags starting with 6003,xx will belong to the GEMS_Ultrasound_ImageGroup_001.

3.6 CONFIGURATION

Not Applicable.

3.7 SUPPORT OF EXTENDED CHARACTER SETS

LOGIQ E8 will support the ISO IR 100 (ISO 8859-1:1987 Latin alphabet N 1. supplementary set). Any incoming SOP instance that is encoded using another extended character set will not be read.

4. ULTRASOUND IMAGE INFORMATION OBJECT IMPLEMENTATION

4.1 INTRODUCTION

This section specifies the use of the DICOM US Image IOD to represent the information included in US Images produced by this implementation. Corresponding attributes are conveyed using the module construct.

4.2 LOGIQ E8 MAPPING OF DICOM ENTITIES

The LOGIQ E8 maps DICOM Information Entities to local Information Entities in the product's database and user interface.

TABLE 4-1
MAPPING OF DICOM ENTITIES TO LOGIQ E8 ENTITIES

DICOM IE	LOGIQ E8 Entity
Patient	Patient
Study	Exam
Series	Series
Image	Image

4.3 IOD MODULE TABLE

The Ultrasound Image Information Object Definition comprises the modules of the following table. The elements not listed are not used by the application.

TABLE 4-2
US IMAGE IOD MODULES

Entity Name	Module Name	Usage	Reference
Patient	Patient	Used	4.4.1.1
	Clinical Trial Subject	Not used	N/A
Study	General Study	Used	4.4.2.1
	Patient Study	Used	4.4.2.2
	Clinical Trial Study	Not used	N/A
Series	General Series	Used	4.4.3.1
	Clinical Trial Series	Not used	N/A
Frame of Reference	Frame of Reference	Not used	N/A
	Synchronization	Not used	N/A
Equipment	General Equipment	Used	4.4.4.1
Image	General Image	Used	4.4.5.1
	Image Pixel	Used	4.4.5.2
	Contrast/Bolus	Used Required if contrast media was	4.4.5.3

	used in this image	
Palette Color Lookup Table	Used Required if photometric Interpretation (0028,0004) has a value of PALETTE COLOR	4.4.5.4
Device	Not used	N/A
US Region Calibration	Used	4.4.5.5
US Image	Used	4.4.5.6
Overlay Plane	Not used	N/A
VOI LUT	Used	0
SOP Common	Used	4.4.5.8

4.4 INFORMATION MODULE DEFINITIONS

Please refer to DICOM Part 3 (Information Object Definitions) for a description of each of the entities, modules, and attributes contained within the US Information Object.

The following modules are included to convey Enumerated Values, Defined Terms, and Optional Attributes supported. Type 1 & Type 2 Attributes are also included for completeness and to define what values they may take and where these values are obtained from when generating the instance. It should be noted that they are the same ones as defined in the DICOM Standard Part 3 (Information Object Definitions). Also note that Attributes not present in tables are not supported.

4.4.1 Patient Entity Modules

4.4.1.1 Patient Module

TABLE 4-3
PATIENT MODULE ATTRIBUTES

Attribute Name	Tag	Type	Attribute Description
Patient's Name	(0010,0010)	2	May be entered from User Interface. Taken from worklist if it is there.
Patient ID	(0010,0020)	2	May be entered from User Interface. Taken from worklist if it is there.
Issuer of Patient ID	(0010,0021)	3	Taken from worklist if it is there.
Patient's Birth Date	(0010,0030)	2	May be entered from User Interface. Taken from worklist if it is there.
Patient's Sex	(0010,0040)	2	May be entered from User Interface. Taken from worklist if it is there.
Referenced Patient Sequence	(0008,1120)	3	Taken from worklist if it is there.
<i>>Include 'SOP Instance Reference Macro'</i>			
Patient's Birth Time	(0010,0032)	3	Taken from worklist if it is there.
Other Patient IDs	(0010,1000)	3	Taken from worklist if it is there.
Other Patient IDs Sequence	(0010,1002)	3	Not supported.
Ethnic Group	(0010,2160)	3	Taken from worklist if it is there.

Patient Comments	(0010,4000)	3	Taken from worklist if it is there.
------------------	-------------	---	-------------------------------------

4.4.2 Study Entity Modules

4.4.2.1 General Study Module

TABLE 4-4
GENERAL STUDY MODULE ATTRIBUTES

Attribute Name	Tag	Type	Attribute Description
Study Instance UID	(0020,000D)	1	Uniquely generated by the equipment. Taken from worklist if it is there.
Study Date	(0008,0020)	2	Is set to examination date
Study Time	(0008,0030)	2	Is set to examination time
Referring Physician's Name	(0008,0090)	2	May be entered from User Interface. Taken from worklist if it is there.
Study ID	(0020,0010)	2	Taken from worklist if it is there (from Requested Procedure ID).
Accession Number	(0008,0050)	2	May be entered from User Interface. Taken from worklist if it is there.
Study Description	(0008,1030)	3	Taken from worklist if it is there (from Requested Procedure Description).
Physician(s) of Record	(0008,1048)	3	Taken from worklist if it is there (from Names of Intended Recipients of Result)
Referenced Study Sequence	(0008,1110)	3	Taken from worklist if it is there. (Not used in SR Documents.)
>Include 'SOP Instance Reference Macro'			

4.4.2.2 Patient Study Module

TABLE 4-5
PATIENT STUDY MODULE ATTRIBUTES

Attribute Name	Tag	Type	Attribute Description
Patient's Size	(0010,1020)	3	May be entered from User Interface. Taken from worklist if it is there.
Patient's Weight	(0010,1030)	3	May be entered from User Interface. Taken from worklist if it is there.
Additional Patient's History	(0010,21B0)	3	Taken from worklist if it is there.

4.4.3 Series Entity Modules

4.4.3.1 General Series Module

TABLE 4-6
GENERAL SERIES MODULE ATTRIBUTES

Attribute Name	Tag	Type	Attribute Description
Modality	(0008,0060)	1	Defined Term "US" used. When reading SC all modalities are accepted.
Series Instance UID	(0020,000E)	1	Uniquely generated by the equipment
Series Number	(0020,0011)	2	Internal number which is incremented for each new series (exam) within a study.
Series Date	(0008,0021)	3	Is set to Series date
Series Time	(0008,0031)	3	Is set to Series time
Performing Physicians' Name	(0008,1050)	3	May be entered from User Interface. Taken from worklist if it is there (from Scheduled Performing Physician's Name)
Protocol Name	(0018,1030)	3	Used in Stress Echo Exam Protocol
Operators' Name	(0008,1070)	3	May be entered from User Interface. Default is login id.
Request Attributes Sequence	(0040,0275)	3	Used if Modality Worklist is enabled.
>Requested Procedure ID	(0040,1001)	1C	Taken from worklist if it is there.
>Accession Number	(0008,0050)	3	Not supported.
>Study Instance UID	(0020,000D)	3	Not supported.
>Referenced Study Sequence	(0008,1110)	3	Not supported.
>> <i>Include 'SOP Instance Reference Macro'</i>			
>Requested Procedure Description	(0032,1060)	3	Not supported.
>Requested Procedure Code Sequence	(0032,1064)	3	Not supported.
>Scheduled Procedure Step ID	(0040,0009)	1C	Taken from worklist if it is there.
>Scheduled Procedure Step Description	(0040,0007)	3	Taken from worklist if it is there.
>Scheduled Protocol Code Sequence	(0040,0008)	3	Not supported.
Performed Procedure Step ID	(0040,0253)	3	Used if Modality Performed Procedure Step is enabled.
Performed Procedure Step Start Date	(0040,0244)	3	Used if Modality Performed Procedure Step is enabled.
Performed Procedure Step Start Time	(0040,0245)	3	Used if Modality Performed Procedure Step is enabled.
Performed Procedure Step Description	(0040,0254)	3	Used if Modality Performed Procedure Step is enabled.
Performed Protocol Code Sequence	(0040,0260)	3	Taken from worklist if it is there (from Scheduled Protocol Code Sequence) or in case of Stress test
>Include 'Code Sequence Macro'		Please refer Table: Table 4-7	

TABLE 4-7
PERFORMED PROTOCOL CODE SEQUENCE MAPPING

GE Value	DICOM Mapping
Bicycle Normal	(P2-31102,SRT,Stress test using Bicycle Ergometer)
Bicycle Sporty	(P2-31102,SRT,Stress test using Bicycle Ergometer)
Contrast Pharmacological	(P2-31107,SRT,Pharmacologic Stress protocol)
Pharmacological 4x4	(P2-31107,SRT,Pharmacologic Stress protocol)
Pharmacological 8x5	(P2-31107,SRT,Pharmacologic Stress protocol)
Exercise 2x4	(P5-B3050,SRT,Exercise stress echocardiography)
Exercise 2x4 B	(P5-B3050,SRT,Exercise stress echocardiography)
Pharmacological US 4x4	(P2-31107,SRT,Pharmacologic Stress protocol)

4.4.4 Equipment Entity Modules

4.4.4.1 General Equipment Module

TABLE 4-8
GENERAL EQUIPMENT MODULE ATTRIBUTES

Attribute Name	Tag	Type	Attribute Description
Manufacturer	(0008,0070)	2	Is set to "GE Healthcare"
Institution Name	(0008,0080)	3	Is set to configured Institution Name.
Station Name	(0008,1010)	3	Is set to configured Station Name.
Institutional Department Name	(0008,1040)	3	May be entered from User Interface. Default is configured Department name.
Manufacturer's Model Name	(0008,1090)	3	Is set to "LOGIQE8".
Software Versions	(0018,1020)	3	Is set to LOGIQ E8 software version

4.4.5 Image Entity Modules

4.4.5.1 General Image Module

TABLE 4-9
GENERAL IMAGE MODULE ATTRIBUTES

Attribute Name	Tag	Type	Attribute Description
Instance Number	(0020,0013)	2	Internal value which is incremented for each captured image within a series. (within an exam)
Patient Orientation	(0020,0020)	2C	Sent with empty value.
Content Date	(0008,0023)	2C	Set from Image date
Content Time	(0008,0033)	2C	Set from Image time
Image Type	(0008,0008)	3	The first two values contain 'ORIGINAL/PRIMARY' or 'DERIVED/ PRIMARY'. Value 3 is the description of the type of

			<p>application per the DICOM PS3.3-2011, section C.8.5.6.1.1; Supported enumerated values are: ABDOMINAL GYNECOLOGY OBSTETRICAL PEDIATRIC SMALL PARTS VASCULAR SCROTAL INTRACARDIAC</p> <p>Value 4 is a description of the mode per the DICOM PS3.3-2011, section C.8.5.6.1.1; Supported enumerated values are sum of values in hexadecimal encoded, which based on:</p> <table border="0"> <tr> <td>Value</td> <td>Meaning</td> </tr> <tr> <td>0001</td> <td>2D Imaging</td> </tr> <tr> <td>0002</td> <td>M- Mode</td> </tr> <tr> <td>0004</td> <td>CW Doppler</td> </tr> <tr> <td>0008</td> <td>PW Doppler</td> </tr> <tr> <td>0010</td> <td>Color Doppler</td> </tr> <tr> <td>0020</td> <td>Color M-Mode</td> </tr> <tr> <td>0040</td> <td>3D Rendering</td> </tr> <tr> <td>0100</td> <td>Color Power Mode</td> </tr> </table> <p>Values 5 and 6 may be used for private data.</p>	Value	Meaning	0001	2D Imaging	0002	M- Mode	0004	CW Doppler	0008	PW Doppler	0010	Color Doppler	0020	Color M-Mode	0040	3D Rendering	0100	Color Power Mode
Value	Meaning																				
0001	2D Imaging																				
0002	M- Mode																				
0004	CW Doppler																				
0008	PW Doppler																				
0010	Color Doppler																				
0020	Color M-Mode																				
0040	3D Rendering																				
0100	Color Power Mode																				
Lossy Image Compression	(0028,2110)	3	Set to 01, if image is lossy compressed.																		
Lossy Image Compression Ratio	(0028,2112)	3	Used if lossy compressed.																		

4.4.5.2 Image Pixel Module

TABLE 4-10
IMAGE PIXEL MODULE ATTRIBUTES

Attribute Name	Tag	Type	Attribute Description
Samples per Pixel	(0028,0002)	1	<p>Value of '1' if Photometric Interpretation element value has value 'MONOCHROME2', 'PALETTE COLOR'</p> <p>Value of '3' when Photometric Interpretation element value has value 'RGB',</p>

			'YBR_FULL' 'YBR_FULL_422' 'YBR_RCT' 'YBR_ICT'
Photometric Interpretation	(0028,0004)	1	Defined Values used: 'MONOCHROME2 ', (Encoding and Display) 'PALETTE COLOR' (Display only) 'RGB', (Compression sets to JPEG Lossless) 'YBR_FULL' (Compression sets to RLE) 'YBR_FULL_422' (Compression sets to JPEG Lossy) 'YBR_RCT' (Compression sets to JPEG 2000 Lossless) 'YBR_ICT' (Compression sets to JPEG 2000 Lossy)
Rows	(0028,0010)	1	Value depends on scanning mode and configuration setup
Columns	(0028,0011)	1	Value depends on scanning mode and configuration setup
Bits Allocated	(0028,0100)	1	Value always = 0008H.
Bits Stored	(0028,0101)	1	Value always = 0008H.
High Bit	(0028,0102)	1	Value always = 0007H.
Pixel Representation	(0028,0103)	1	Defined Value '0' - unsigned integer.
Pixel Data	(7FE0,0010)	1	Pixel Data of image.
Planar Configuration	(0028,0006)	1C	Enumerated Values: 0000H = color-by-pixel, if Photometric Interpretation element value has value RGB, YBR_RCT, YBR_ICT or YBR_FULL_422. 0001H = color by plane, if Photometric Interpretation element has value YBR_FULL.
Pixel Aspect Ratio	(0028,0034)	1C	Not used
Red Palette Color Lookup Table Descriptor	(0028,1101)	1C	Only used when reading Palette images.
Green Palette Color Lookup Table Descriptor	(0028,1102)	1C	Only used when reading Palette images.
Blue Palette Color Lookup Table Descriptor	(0028,1103)	1C	Only used when reading Palette images.
Red Palette Color Lookup Table Data	(0028,1201)	1C	Only used when reading Palette images.
Green Palette Color Lookup Table Data	(0028,1202)	1C	Only used when reading Palette images.
Blue Palette Color Lookup Table Data	(0028,1203)	1C	Only used when reading Palette images.

4.4.5.3 Contrast/Bolus Module

TABLE 4-11
CONTRAST/BOLUS MODULE ATTRIBUTES

Attribute Name	Tag	Type	Attribute Description
Contrast/Bolus Agent	(0018,0010)	2	Contrast Agent won't be sent if no Contrast Agent was used to acquire images. If contrast agent is used, the value is taken from worklist (Requested Contrast Agent).

4.4.5.4 Palette Color Lookup Table Module

TABLE 4-12
PALETTE COLOR LOOKUP MODULE

Attribute Name	Tag	Type	Use
Red Palette Color Lookup Table Descriptor	(0028,1101)	1	Only used when reading Palette images.
Green Palette Color Lookup Table Descriptor	(0028,1102)	1	Only used when reading Palette images.
Blue Palette Color Lookup Table Descriptor	(0028,1103)	1	Only used when reading Palette images.
Red Palette Color Lookup Table Data	(0028,1201)	1C	Only used when reading Palette images.
Green Palette Color Lookup Table Data	(0028,1202)	1C	Only used when reading Palette images.
Blue Palette Color Lookup Table Data	(0028,1203)	1C	Only used when reading Palette images.

4.4.5.5 US Region Calibration Module

US Region Calibration Module is used to describe multiple regions. Note: if a multi-frame image has been acquired with different calibration, the US Region Calibration Module will not be used.

TABLE 4-13
US REGION CALIBRATION MODULE ATTRIBUTES

Attribute Name	Tag	Type	Use
Sequence of Ultrasound Regions	(0018,6011)	1	Object contains 1 or more regions
>Region Location Min x_0	(0018,6018)	1	Value is 0
>Region Location Min y_0	(0018,601A)	1	Value is 0
>Region Location Max x_1	(0018,601C)	1	Value is image width-1
>Region Location Max y_1	(0018,601E)	1	Value is image height-1
>Physical Units X Direction	(0018,6024)	1	Enumerated Values supported: 0003H cm 0004H seconds
>Physical Units Y Direction	(0018,6026)	1	Enumerated Values supported: 0003H cm 0004H seconds 0007H cm/sec

>Physical Delta X	(0018,602C)	1	Varies with scanning mode
>Physical Delta Y	(0018,602E)	1	Varies with scanning mode
>Reference Pixel x_0	(0018,6020)	3	Varies with scanning mode
>Reference Pixel y_0	(0018,6022)	3	Varies with scanning mode
>Ref. Pixel Physical Value X	(0018,6028)	3	Varies with scanning mode
>Ref. Pixel Physical Value Y	(0018,602A)	3	Varies with scanning mode
>Region Spatial Format	(0018,6012)	1	Supported. The spatial organization of the data within the region. Supported enumerated values are: Value Meaning 0000H None or not applicable 0001H 2D (tissue or flow) 0002H M -Mode (tissue or flow) 0003H Spectral (CW or PW Doppler) Per the DICOM PS3.3-2011, section C.8.5.5.1.1
>Region Data Type	(0018,6014)	1	Supported. The type of data within the region. Supported enumerated values are: Value Meaning 0000H None or not applicable 0001H Tissue 0002H Color Flow 0003H PW Spectral Doppler 0004H CW Spectral Doppler 0006H Doppler Mode Trace Per the DICOM PS3.3-2011, section C.8.5.5.1.2
>Region Flags	(0018,6016)	1	Bit 0: 0 = Opaque Bit 1: 0 = Not Protected because there may be other regions within the image Bit 2: 0 = Velocity
>Transducer Frequency	(0018,6030)	3	Supported
>Pulse Repetition Frequency	(0018,6032)	3	Supported

4.4.5.6 US Image Module

This section specifies the Attributes that describe ultrasound images.

TABLE 4-14
US IMAGE MODULE ATTRIBUTES

Attribute Name	Tag	Type	Use
Samples Per Pixel	(0028,0002)	1	Value of '1' if Photometric Interpretation element value has value 'MONOCHROME2' or 'PALETTE COLOR' Value of '3' when Photometric Interpretation

			<p>element value has value</p> <p>'RGB', (Compression sets to JPEG Lossless)</p> <p>'YBR_FULL' (Compression sets to RLE)</p> <p>'YBR_FULL_422' (Compression sets to JPEG Lossy)</p> <p>'YBR_RCT' (Compression sets to JPEG 2000 Lossless)</p> <p>'YBR_ICT' (Compression sets to JPEG 2000 Lossy)</p>
Photometric Interpretation	(0028,0004)	1	<p>Defined Values used:</p> <p>'MONOCHROME2',</p> <p>'RGB',</p> <p>'PALETTE COLOR'</p> <p>'YBR_FULL',</p> <p>'YBR_FULL_422',</p> <p>'YBR_RCT',</p> <p>'YBR_ICT'</p>
Bits Allocated	(0028,0100)	1	Value always = 0008H
Bits Stored	(0028,0101)	1	Value always = 0008H
High Bit	(0028,0102)	1	Value always = 0007H
Planar Configuration	(0028,0006)	1C	<p>Enumerated Values:</p> <p>0000H = color-by-pixel, if Photometric Interpretation element value has value RGB, YBR_RCT, YBR_ICT or YBR_FULL_422.</p> <p>0001H = color by plane, if Photometric Interpretation element has value YBR_FULL.</p>
Pixel Representation	(0028,0103)	1	Always 0000H = unsigned integer.
Frame Increment Pointer	(0028,0009)	1C	Export: Is set to Frame Time (0018,1063) or Frame Time Vector (0018,1065) if the image is multiframe IOD, Not used if the image is a single frame IOD.
Image Type	(0008,0008)	2	<p>The first two values contain 'ORIGINAL/PRIMARY' or 'DERIVED/ PRIMARY'.</p> <p>Value 3 is the description of the type of application per the DICOM PS3.3-2011, section C.8.5.6.1.1; Supported enumerated values are:</p> <p>ABDOMINAL</p> <p>GYNECOLOGY</p> <p>OBSTETRICAL</p> <p>PEDIATRIC</p> <p>SMALL PARTS</p>

			<p>VASCULAR SCROTAL INTRACARDIAC</p> <p>Value 4 is a description of the mode per the DICOM PS3.3-2011, section C.8.5.6.1.1; Supported enumerated values are sum of values in hexadecimal encoded, which based on:</p> <table> <thead> <tr> <th>Value</th> <th>Meaning</th> </tr> </thead> <tbody> <tr> <td>0001</td> <td>2D Imaging</td> </tr> <tr> <td>0002</td> <td>M- Mode</td> </tr> <tr> <td>0004</td> <td>CW Doppler</td> </tr> <tr> <td>0008</td> <td>PW Doppler</td> </tr> <tr> <td>0010</td> <td>Color Doppler</td> </tr> <tr> <td>0020</td> <td>Color M-Mode</td> </tr> <tr> <td>0040</td> <td>3D Rendering</td> </tr> <tr> <td>0100</td> <td>Color Power Mode</td> </tr> </tbody> </table> <p>Values 5 and 6 may be used for private data.</p>	Value	Meaning	0001	2D Imaging	0002	M- Mode	0004	CW Doppler	0008	PW Doppler	0010	Color Doppler	0020	Color M-Mode	0040	3D Rendering	0100	Color Power Mode
Value	Meaning																				
0001	2D Imaging																				
0002	M- Mode																				
0004	CW Doppler																				
0008	PW Doppler																				
0010	Color Doppler																				
0020	Color M-Mode																				
0040	3D Rendering																				
0100	Color Power Mode																				
Lossy Image Compression	(0028,2110)	1C	Set to 01 if image is compressed using JPEG Baseline or JPEG 2000 Lossy compression.																		
Number of Stages	(0008,2124)	2C	Used in case of Stress Echo exams.																		
Number of Views in Stage	(0008,212A)	2C	Used in case of Stress Echo exams.																		
Stage Name	(0008,2120)	3	Name of stage of stress test. Sent if image is acquired in a stress test. The name is defined in the User Interface.																		
Stage Code Sequence	(0040,000A)	3	Used in case of Stress Echo exams. Please refer Table: Table 4-15 for Stage Code Sequence macros.																		
Stage Number	(0008,2122)	3	Number of stage, starting at one. Sent if image is acquired in a stress test.																		
View Name	(0008,2127)	3	Name of view of stress test. Sent if image is acquired in a stress test. The name is defined in the User Interface.																		
View Number	(0008,2128)	3	Number of view, starting at one. Sent if image is acquired in a stress test.																		
View Code Sequence	(0054,0220)	3	Used in case of Stress Echo exams. Please refer Table: Table 4-16 for View Code Sequence macros.																		
Acquisition DateTime	(0008,002A)	1C	Not Used.																		
Heart Rate	(0018,1088)	3	Set to heart rate																		

TABLE 4-15
STAGE CODE SEQUENCE MAPPING

GE Value	DICOM Mapping
Rest	(F-01604,SRT,Resting State)
Peak	(F-05028,SRT,Peak cardiac stress state)
Baseline	(F-01604,SRT,Resting State)
Low dose	(F-05019,SRT,Cardiac stress state)
Peak dose	(F-05028,SRT,Peak cardiac stress state)
Recovery	(F-05018,SRT,Cardiac stress recovery state)

TABLE 4-16
VIEW CODE SEQUENCE MAPPING

GE Value	DICOM Mapping
4CH	(G-A19C,SRT,Apical four chamber)
2CH	(G-A19B,SRT,Apical two chamber)
PLAX	(G-0396,SRT,Parasternal long axis)
APLAX	(G-0395,SRT,Apical long axis)
SAX-PM	(G-039B,SRT,Parasternal short axis at the Papillary Muscle level)
SAX-MV	(G-039A,SRT,Parasternal short axis at the Mitral Valve level)

4.4.5.7 VOI LUT module

TABLE 4-17
VOI LUT MODULE ATTRIBUTES

Attribute Name	Tag	Type	Attribute Description
Window Center	(0028,1050)	1C	Value set to 127 if Photometric Interpretation has value MONOCHROME2.
Window Width	(0028,1051)	1C	Value set to 256 if Photometric Interpretation has value MONOCHROME2.

4.4.5.8 SOP Common Module

TABLE 4-18
SOP COMMON MODULE ATTRIBUTES

Attribute Name	Tag	Type	Attribute Description
SOP Class UID	(0008,0016)	1	Set to “1.2.840.10008.5.1.4.1.1.3.1” “1.2.840.10008.5.1.4.1.1.3” “1.2.840.10008.5.1.4.1.1.6.1” “1.2.840.10008.5.1.4.1.1.6” “1.2.840.10008.5.1.4.1.1.7” “1.2.840.10008.5.1.4.1.1.6.2” “1.2.840.10008.5.1.4.1.1.88.59” or “1.2.840.10008.5.1.4.1.1.88.33”
SOP Instance UID	(0008,0018)	1	Uniquely generated by the equipment

DIR DOC1585895 REV 2

Specific Character Set	(0008,0005)	1C	Set to ISO_IR100 if extended characters are used. Image Read: images using other set than ISO_IR 100 are rejected.
Instance Number	(0020,0013)	3	Internal value which is incremented for each captured image within a series. (within an exam)

5. ULTRASOUND MULTI-FRAME IMAGE INFORMATION OBJECT IMPLEMENTATION

5.1 INTRODUCTION

This section specifies the use of the DICOM US Multi-Frame Image IOD to represent the information included in US Multi-Frame Images produced by this implementation. Corresponding attributes are conveyed using the module construct.

5.2 LOGIQ E8 MAPPING OF DICOM ENTITIES

The LOGIQ E8 maps DICOM Information Entities to local Information Entities in the product's database and user interface.

TABLE 5-1
MAPPING OF DICOM ENTITIES TO LOGIQ E8 ENTITIES

DICOM IE	LOGIQ E8 Entity
Patient	Patient
Study	Exam
Series	Series
Image	Image

5.3 IOD MODULE TABLE

The Ultrasound Multi-Frame Image Information Object Definition comprises the modules of the following table. The elements not listed are not used by the application.

TABLE 5-2
US MULTI-FRAME IMAGE IOD MODULES

Entity Name	Module Name	Usage	Reference
Patient	Patient	Used	4.4.1.1
	Clinical Trial Subject	Not used	N/A
Study	General Study	Used	4.4.2.1
	Patient Study	Used	4.4.2.2
	Clinical Trial Study	Not used	N/A
Series	General Series	Used	4.4.3.1
	Clinical Trial Series	Not used	N/A
Frame of Reference	Frame of Reference	Not Used	N/A
	Synchronization	Not Used	N/A
Equipment	General Equipment	Used	4.4.4.1
Image	General Image	Used	4.4.5.1
	Image Pixel	Used	4.4.5.2
	Contrast/Bolus	Used	4.4.5.3
	Cine	Used	5.4.1.1

Multi-Frame	Used	5.4.1.2
Frame Pointers	Not used	N/A
Palette Color Lookup Table	Used	4.4.5.4
Device	Not used	N/A
US Region Calibration	Used	4.4.5.5
US Image	Used	4.4.5.6
VOI LUT	Used	0
SOP Common	Used	4.4.5.8

5.4 INFORMATION MODULE DEFINITIONS

Please refer to DICOM Part 3 (Information Object Definitions) for a description of each of the entities, modules, and attributes contained within the US Multi-Frame Information Object.

The following modules are included to convey Enumerated Values, Defined Terms, and Optional Attributes supported. Type 1 & Type 2 Attributes are also included for completeness and to define what values they may take and where these values are obtained from when generating the instance. It should be noted that they are the same ones as defined in the DICOM Standard Part 3 (Information Object Definitions). Also note that Attributes not present in tables are not supported.

5.4.1 Image Entity Modules

5.4.1.1 Cine Module

**TABLE 5-3
CINE MODULE ATTRIBUTES**

Attribute Name	Tag	Type	Attribute Description
Preferred Playback Sequencing	(0018,1244)	3	Supported
Frame Time	(0018,1063)	1C	Is set to the interframe time
Frame Time Vector	(0018,1065)	1C	Supported. Reading: Average value is set to interframe time
Start Trim	(0008,2142)	3	Supported
Stop Trim	(0008,2143)	3	Supported
Recommended Display Frame Rate	(0008,2144)	3	Supported
Cine Rate	(0018,0040)	3	Supported
Frame Delay	(0018,1066)	3	Supported
Effective Duration	(0018,0072)	3	Supported
Actual Frame Duration	(0018,1242)	3	Supported

5.4.1.2 Multi-Frame Module

**TABLE 5-4
MULTI-FRAME MODULE ATTRIBUTES**

Attribute Name	Tag	Type	Attribute Description
----------------	-----	------	-----------------------

DIR DOC1585895 REV 2

Number of Frames	(0028,0008)	1	Is set to the number of frames in image
Frame Increment Pointer	(0028,0009)	1	Is set to Frame Time (0018,1063) or Frame Time Vector (0018,1065)

6. ENHANCED US VOLUME INFORMATION OBJECT IMPLEMENTATION

6.1 INTRODUCTION

This section specifies the use of the DICOM Enhanced US Volume IOD to represent the information included in Enhanced US Volume Images produced by this implementation. Corresponding attributes are conveyed using the module construct.

6.2 LOGIQ E8 MAPPING OF DICOM ENTITIES

The LOGIQ E8 maps DICOM Information Entities to local Information Entities in the product's database and user interface.

TABLE 6-1
MAPPING OF DICOM ENTITIES TO LOGIQ E8 ENTITIES

DICOM IE	LOGIQ E8 Entity
Patient	Patient
Study	Exam
Series	Series
Image	Image

6.3 IOD MODULE TABLE

The Enhanced US Volume Information Object Definition comprises the modules of the following table. The elements not listed are not used by the application.

TABLE 6-2
ENHANCED US VOLUME IOD MODULES

Entity Name	Module Name	Usage	Reference
Patient	Patient	Used	4.4.1.1
	Clinical Trial Subject	Not used	N/A
Study	General Study	Used	4.4.2.1
	Patient Study	Used	4.4.2.2
	Clinical Trial Study	Not used	N/A
Series	General Series	Used	4.4.3.1
	Enhanced US Series	Used	6.4.1.1
	Clinical Trial Series	Not used	N/A
Frame of Reference	Frame of Reference	Used	6.4.2.1
	Ultrasound Frame of Reference	Used	6.4.2.1.1
	Synchronization	Used	6.4.2.2

Equipment	General Equipment	Used	4.4.4.1
	Enhanced General Equipment	Used	6.4.3.1
Image	General Image	Used	4.4.5.1
	Image Pixel	Used	4.4.5.2
	Enhanced Contrast/Bolus	Not used	N/A
	Multi-frame Functional Groups	Used	6.4.4.1
	Multi-frame Dimension	Used	6.4.4.2
	Cardiac Synchronization	Not used	N/A
	Respiratory Synchronization	Not used	N/A
	Device	Not used	N/A
	Acquisition Context	Used	6.4.4.3
	Specimen	Not used	N/A
	Enhanced Palette Color Lookup Table	Used	6.4.4.4
	Enhanced US Image	Used	6.4.4.5
	IVUS Image	Not used	N/A
	Excluded Intervals	Not used	N/A
	ICC Profile	Not used	N/A
	SOP Common	Used	4.4.5.8
Frame Extraction	Not used	N/A	

6.4 INFORMATION MODULE DEFINITIONS

Please refer to DICOM Part 3 (Information Object Definitions) for a description of each of the entities, modules, and attributes contained within the Enhanced US Volume Information Object.

The following modules are included to convey Enumerated Values, Defined Terms, and Optional Attributes supported. Type 1 & Type 2 Attributes are also included for completeness and to define what values they may take and where these values are obtained from when generating the instance as well as what are the expected values when loading such instance. It should be noted that they are the same ones as defined in the DICOM Standard Part 3 (Information Object Definitions). Also note that Attributes not present in tables are not supported.

DIR DOC1585895 REV 2

6.4.1 Series Entity Modules**6.4.1.1 Enhanced US Series**

**TABLE 6-3
ENHANCED US SERIES MODULE ATTRIBUTES**

Attribute Name	Tag	Type	Attribute Description
Modality	(0008,0060)	1	Set to US.
Referenced Performed Procedure Step Sequence	(0008,1111)	1C	Used if Modality Performed Procedure Step is enabled.
<i>>Include 'SOP Instance Reference Macro' Table 10-11</i>			
Performed Protocol Code Sequence	(0040,0260)	1C	Not Used.
Performed Protocol Type	(0040,0261)	1C	Not applicable.

6.4.2 Frame Of Reference Entity Modules**6.4.2.1 Frame Of Reference Module**

**TABLE 6-4
FRAME OF REFERENCE MODULE ATTRIBUTES**

Attribute Name	Tag	Type	Attribute Description
Frame of Reference UID	(0020,0052)	1	Used.
Position Reference Indicator	(0020,1040)	2	Set as empty.

6.4.2.1.1 Ultrasound Frame of Reference

**TABLE 6-5
ULTRASOUND FRAME OF REFERENCE MODULE ATTRIBUTES**

Attribute Name	Tag	Type	Attribute Description
Volume Frame of Reference UID	(0020,9312)	1	Used.
Ultrasound Acquisition Geometry	(0020,9307)	1	Set with defined term "APEX".
Apex Position	(0020,9308)	1C	Used.
Volume to Transducer Mapping Matrix	(0020,9309)	1	Used.
Patient Frame of Reference Source	(0020,930C)	1C	Not used.
Table Frame of Reference UID	(0020,9313)	1C	Not used.
Volume to Table Mapping Matrix	(0020,930A)	1C	Not used.

6.4.2.2 Synchronization Module

**TABLE 6-6
SYNCHRONIZATION MODULE ATTRIBUTES**

Attribute Name	Tag	Type	Attribute Description
Synchronization Frame of Reference UID	(0020,0200)	1	Used.
Synchronization Trigger	(0018,106A)	1	Enumerated Value "NO TRIGGER" used.

Synchronization Channel	(0018,106C)	1C	Not used.
Acquisition Time Synchronized	(0018,1800)	1	Enumerated Value "N" used.

6.4.3 Equipment Entity Modules

6.4.3.1 Enhanced General Equipment Module

TABLE 6-7
ENHANCED GENERAL EQUIPMENT MODULE ATTRIBUTES

Attribute Name	Tag	Type	Attribute Description
Manufacturer	(0008,0070)	1	Set with "GE Healthcare".
Manufacturer's Model Name	(0008,1090)	1	Set with "LOGIQE8".
Device Serial Number	(0018,1000)	1	Set with "LOGIQEDCM3D".
Software Versions	(0018,1020)	1	Is set to LOGIQ E8 software version.

6.4.4 Image Entity Modules

6.4.4.1 Multi-frame Functional Groups

TABLE 6-8
MULTI-FRAME FUNCTIONAL GROUPS MODULE ATTRIBUTES

Attribute Name	Tag	Type	Attribute Description
Shared Functional Groups Sequence	(5200,9229)	2	Used.
>US Image Description Sequence	(0018,9806)	1	Used.
>>Frame Type	(0008,9007)	1	<p>The first two values contain 'ORIGINAL/PRIMARY' or 'DERIVED/ PRIMARY'.</p> <p>Value 3 is the description of the type of application per the DICOM PS3.3-2011, section C.8.5.6.1.1;</p> <p>Supported enumerated values are:</p> <p>ABDOMINAL GYNECOLOGY OBSTETRICAL PEDIATRIC SMALL PARTS VASCULAR SCROTAL INTRACARDIAC</p> <p>Value 4 is a description of the mode per the DICOM PS3.3-2011, section C.8.5.6.1.1;</p> <p>Supported enumerated values are sum of values in hexadecimal encoded, which based on:</p>

			Value	Meaning
			0001	2D Imaging
			0002	M- Mode
			0004	CW Doppler
			0008	PW Doppler
			0010	Color Doppler
			0020	Color M-Mode
			0040	3D Rendering
			0100	Color Power Mode
			Values 5 and 6 may be used for private data..	
>>Volumetric Properties	(0008,9206)	1	Set with "VOLUME".	
>>Volume Based Calculation Technique	(0008,9207)	1	Set with "NONE".	
>Plane Orientation (Volume) Sequence	(0020,930F)	1	Used.	
>>Image Orientation (Volume)	(0020,9302)	1	Set with "1¥0¥0¥0¥1¥0".	
>Temporal Position Sequence	(0020,9310)	1	Used.	
>>Temporal Position Time Offset	(0020,930D)	1	Used.	
>Frame VOI LUT Sequence	(0028,9132)	1	Used.	
>>Window Center	(0028,1050)	1	Used.	
>>Window Width	(0028,1051)	1	Used.	
Per-frame Functional Groups Sequence	(5200,9230)	1	Used.	
>Image Data Type Sequence	(0018,9807)	1	Used.	
>>Data Type	(0018,9808)	1	Set with "TISSUE_INTENSITY" or "FLOW_VELOCITY" or "FLOW_POWER".	
>>Aliased Data Type	(0018,980B)	1	Set to "NO".	

>Frame Content Sequence	(0020,9111)	1	Used.
>>Frame Reference DateTime	(0018,9151)	1C	Set with the date and time of the acquisition frame created. Used if Frame Type (0008,9007) Value 1 of this frame is ORIGINAL. May be present otherwise..
>>Frame Acquisition DateTime	(0018,9074)	1C	Set with the date and time of the acquisition frame started. Used if Frame Type (0008,9007) Value 1 of this frame is ORIGINAL. May be present otherwise.
>>Frame Acquisition Duration	(0018,9220)	1C	Set with the duration of the time. Used if Frame Type (0008,9007) Value 1 of this frame is ORIGINAL. May be present otherwise.
>>Dimension Index Values	(0020,9157)	1C	Set with 3 values. Each value fills with the dimension specific information. Used if Frame Type (0008,9007) Value 1 of this frame is ORIGINAL. May be present otherwise.
>Plane Position (Volume) Sequence	(0020,930E)	1	Used.
>>Image Position (Volume)	(0020,9301)	1	First value (X) and second value (Y) are set to zero. The third value is set to the plane position in mm.
>Temporal Position Sequence	(0020,9310)	1	Used.
>>Temporal Position Time Offset	(0020,930D)	1	Used.
>Frame VOI LUT Sequence	(0028,9132)	1	Used.
>>Window Center	(0028,1050)	1	Used.
>>Window Width	(0028,1051)	1	Used.
Instance Number	(0020,0013)	1	Used.
Content Date	(0008,0023)	1	Used.
Content Time	(0008,0033)	1	Used.
Number of Frames	(0028,0008)	1	Used.
Concatenation UID	(0020,9161)	1C	Not used.

6.4.4.2 Multi-frame Dimension

TABLE 6-9
MULTI-FRAME DIMENSION MODULE ATTRIBUTES

Attribute Name	Tag	Type	Attribute Description
Dimension Organization Sequence	(0020,9221)	1	Used.
>Dimension Organization UID	(0020,9164)	1	Used.
Dimension Organization Type	(0020,9311)	3	Set with “3D” in case of Static 3D dataset or “3D_TEMPORAL” in case of 4D dataset.
Dimension Index Sequence	(0020,9222)	1	Three items are sent.
>Dimension Index Pointer	(0020,9165)	1	There are three values. “Temporal Position Time Offset” or “Image Position (Volume)” or “Data Type”.
>Functional Group Pointer	(0020,9167)	1C	There are three values. “Temporal Position Sequence” or “Plane Position Volume Sequence” or “Image Data Type Sequence”.
>Dimension Organization UID	(0020,9164)	1C	Set with unique id.

6.4.4.3 Acquisition Context

TABLE 6-10
ACQUISITION CONTEXT MODULE ATTRIBUTES

Attribute Name	Tag	Type	Attribute Description
Acquisition Context Sequence	(0040,0555)	2	Set as empty.

6.4.4.4 Enhanced Palette Color Lookup Table

TABLE 6-11
ENHANCED PALETTE COLOR LOOKUP TABLE MODULE ATTRIBUTES

Attribute Name	Tag	Type	Attribute Description
Data Frame Assignment Sequence	(0028,1401)	1	Sequence of items each assigning frames of one particular value of Data Type (0018,9808) to a data path in the Enhanced Blending and Display Pipeline. One, two, or three items shall be included in this sequence.
>Data Type	(0018,9808)	1	Set with “TISSUE_INTENSITY” or “FLOW_VELOCITY” or “FLOW_POWER”.
>Data Path Assignment	(0028,1402)	1	Set with following Enumerated values. PRIMARY_SINGLE SECONDARY_SINGLE SECONDARY_HIGH SECONDARY_LOW
Blending LUT 1 Sequence	(0028,1404)	1C	Used if there are one or more items of the Data Path Assignment Sequence (0028,1402) other than PRIMARY_PVALUES.

>Blending LUT 1 Transfer Function	(0028,1405)	1	Supported Enumerated values: CONSTANT ALPHA_1 ALPHA_2 TABLE See DICOM PS3.3, section C.7.6.23.4 for details.
>Blending Weight Constant	(0028,1406)	1C	Used if (0028,1405) value is "CONSTANT".
>Blending Lookup Table Descriptor	(0028,1407)	1C	Used if (0028,1405) value is "TABLE".
>Blending Lookup Table Data	(0028,1408)	1C	Used if (0028,1405) value is "TABLE".
Blending LUT 2 Sequence	(0028,140C)	1C	Used if there are one or more items of the Data Path Assignment Sequence (0028,1402) other than PRIMARY_PVALUES.
>Blending LUT 2 Transfer Function	(0028,140D)	1	Supported Enumerated values: CONSTANT ONE_MINUS ALPHA_1 ALPHA_2 TABLE See DICOM PS3.3, C.7.6.23.4 for details.
>Blending Weight Constant	(0028,1406)	1C	Used if (0028,140D) is CONSTANT.
>Blending Lookup Table Descriptor	(0028,1407)	1C	Used if (0028,140D) is TABLE.
>Blending Lookup Table Data	(0028,1408)	1C	Used if (0028,140D) is TABLE.
Enhanced Palette Color Lookup Table Sequence	(0028,140B)	1C	Used if Data Path Assignment (0028,1402) is present with a value other than PRIMARY_PVALUES.
>Data Path ID	(0028,140E)	1	Used below enumerated values. PRIMARY SECONDARY
>RGB LUT Transfer Function	(0028,140F)	1	Set with "TABLE".
>Alpha LUT Transfer Function	(0028,1410)	1	Set with either "NONE" or "TABLE".
>Red Palette Color Lookup Table Descriptor	(0028,1101)	1C	Used.
>Green Palette Color Lookup Table Descriptor	(0028,1102)	1C	Used.
>Blue Palette Color Lookup Table Descriptor	(0028,1103)	1C	Used.
>Alpha Palette Color Lookup Table Descriptor	(0028,1104)	1C	Used.
>Red Palette Color Lookup Table Data	(0028,1201)	1C	Used.
>Green Palette Color Lookup Table Data	(0028,1202)	1C	Used.
>Blue Palette Color Lookup Table Data	(0028,1203)	1C	Used.
>Alpha Palette Color Lookup Table Data	(0028,1204)	1C	Used.
ICC Profile	(0028,2000)	1C	Not used.

**TABLE 6-12
ENHANCED US IMAGE MODULE ATTRIBUTES**

Attribute Name	Tag	Type	Attribute Description																		
Image Type	(0008,0008)	1	<p>The first two values contain 'ORIGINAL/PRIMARY' or 'DERIVED/ PRIMARY'.</p> <p>Value 3 is the description of the type of application per the DICOM PS3.3-2011, section C.8.5.6.1.1;</p> <p>Supported enumerated values are: ABDOMINAL GYNECOLOGY OBSTETRICAL PEDIATRIC SMALL PARTS VASCULAR SCROTAL INTRACARDIAC</p> <p>Value 4 is a description of the mode per the DICOM PS3.3-2011, section C.8.5.6.1.1;</p> <p>Supported enumerated values are sum of values in hexadecimal encoded, which based on:</p> <table border="0"> <tr> <td>Value</td> <td>Meaning</td> </tr> <tr> <td>0001</td> <td>2D Imaging</td> </tr> <tr> <td>0002</td> <td>M- Mode</td> </tr> <tr> <td>0004</td> <td>CW Doppler</td> </tr> <tr> <td>0008</td> <td>PW Doppler</td> </tr> <tr> <td>0010</td> <td>Color Doppler</td> </tr> <tr> <td>0020</td> <td>Color M-Mode</td> </tr> <tr> <td>0040</td> <td>3D Rendering</td> </tr> <tr> <td>0100</td> <td>Color Power Mode</td> </tr> </table> <p>Values 5 and 6 may be used for private data.</p>	Value	Meaning	0001	2D Imaging	0002	M- Mode	0004	CW Doppler	0008	PW Doppler	0010	Color Doppler	0020	Color M-Mode	0040	3D Rendering	0100	Color Power Mode
Value	Meaning																				
0001	2D Imaging																				
0002	M- Mode																				
0004	CW Doppler																				
0008	PW Doppler																				
0010	Color Doppler																				
0020	Color M-Mode																				
0040	3D Rendering																				
0100	Color Power Mode																				
Samples Per Pixel	(0028,0002)	1	Set with 1.																		
Photometric Interpretation	(0028,0004)	1	Set with MONOCHROME2.																		
Bits Allocated	(0028,0100)	1	Set with 8.																		
Bits Stored	(0028,0101)	1	Set with 8.																		
High Bit	(0028,0102)	1	Set with 7.																		
Pixel Representation	(0028,0103)	1	Set with 0.																		

Dimension Organization Type	(0020,9311)	1	Set with “3D” in case of Static 3D dataset or “3D_TEMPORAL” in case of 4D dataset.
Acquisition DateTime	(0008,002A)	1	Used.
Acquisition Duration	(0018,9073)	1	Used.
Pixel Spacing	(0028,0030)	1	Used.
Position Measuring Device Used	(0018,980C)	1C	Set with “RIGID”.
Lossy Image Compression	(0028,2110)	1C	Set to 1 in case of Lossy otherwise set with 0.
Lossy Image Compression Ratio	(0028,2112)	1C	Used if (0028,2110) value is 1.
Lossy Image Compression Method	(0028,2114)	1C	Used if (0028,2110) value is 1.
Presentation LUT Shape	(2050,0020)	1	Set with “IDENTITY”.
Rescale Intercept	(0028,1052)	1	Set to 0.
Rescale Slope	(0028,1053)	1	Set to 1.
Source Image Sequence	(0008,2112)	1C	Not used.
Number of Stages	(0008,2124)	1C	Not used.
Stage Number	(0008,2122)	1C	Not used.
Stage Code Sequence	(0040,000A)	1C	Not used.
View Code Sequence	(0054,0220)	1	Used.
>Code Value	(0008,0100)	1	Set to “G-A117”.
>Coding Scheme Designator	(0008,0102)	1	Set to “SRT”.
>Code Meaning	(0008,0104)	1	Set to “Transverse”.
Burned In Annotation	(0028,0301)	1	Set to “NO”.
Transducer Scan Pattern Code Sequence	(0018,9809)	1	The scan pattern the transducer is capable of. Only a single item is included in this sequence. See DICOM PS3.3, C.8.24.3.4 for further explanation.
>Code Value	(0008,0100)	1	Set to “125241”.
>Coding Scheme Designator	(0008,0102)	1	Set to “DCM”.
>Code Meaning	(0008,0104)	1	Set to “Plane scan pattern”.
Transducer Geometry Code Sequence	(0018,980D)	1	Geometric structure of the transducer. Only a single item shall be included in this sequence. See DICOM PS3.3, C.8.24.3.4 for further explanation.
>Code Value	(0008,0100)	1	Set to “125254”.
>Coding Scheme Designator	(0008,0102)	1	Set to “DCM”.
>Code Meaning	(0008,0104)	1	Set to “Sector ultrasound transducer geometry”.

Transducer Beam Steering Code Sequence	(0018,980E)	1	Technique used by the transducer for beam steering. One or more items shall be included in this sequence. If more than one item is present, the order is significant from plane-forming technique to volume-forming technique. See DICOM PS3.3, C.8.24.3.4 for further explanation.
>Code Value	(0008,0100)	1	Set to "125258".
>Coding Scheme Designator	(0008,0102)	1	Set to "DCM".
>Code Meaning	(0008,0104)	1	Set to "Mechanical beam steering".
Transducer Application Code Sequence	(0018,980F)	1	The primary clinical application of the transducer. Only a single Item is included in this sequence. See DICOM PS3.3, C.8.24.3.4 for further explanation.
>Code Value	(0008,0100)	1	Set to "125261".
>Coding Scheme Designator	(0008,0102)	1	Set to "DCM".
>Code Meaning	(0008,0104)	1	Set to "External Transducer".
Mechanical Index	(0018,5022)	1	Used.
Bone Thermal Index	(0018,5024)	1	Used.
Cranial Thermal Index	(0018,5026)	1	Used.
Soft Tissue Thermal Index	(0018,5027)	1	Used.
Depth(s) of Focus	(0018,9801)	1	Used.
Depth of Scan Field	(0018,5050)	1	Used.

7. SECONDARY CAPTURE INFORMATION OBJECT IMPLEMENTATION

7.1 INTRODUCTION

This section specifies the use of the DICOM SC Image IOD to represent the information included in SC Images produced by this implementation. Corresponding attributes are conveyed using the module construct.

7.2 LOGIQ E8 MAPPING OF DICOM ENTITIES

The LOGIQ E8 maps DICOM Information Entities to local Information Entities in the product's database and user interface.

TABLE 7-1
MAPPING OF DICOM ENTITIES TO LOGIQ E8 ENTITIES

DICOM IE	LOGIQ E8 Entity
Patient	Patient
Study	Exam
Series	Series
Image	Image

7.3 IOD MODULE TABLE

The Secondary Capture Information Object Definition comprises the modules of the following table. The elements not listed are not used by the application.

TABLE 7-2
SC IMAGE IOD MODULES

Entity Name	Module Name	Usage	Reference
Patient	Patient	Used	4.4.1.1
	Clinical Trial Subject	Not used	N/A
Study	General Study	Used	4.4.2.1
	Patient Study	Used < Need to specify when>	4.4.2.2
	Clinical Trial Study	Not used	N/A
Series	General Series	Used	4.4.3.1
	Clinical Trial Series	Not used	N/A
Equipment	General Equipment	Used < Need to specify when>	4.4.4.1
	SC Equipment	Used	7.4.1.1
Image	General Image	Used	4.4.5.1
	Image Pixel	Used	4.4.5.2
	Device	Not used	N/A
	SC Image	Used	7.4.2.1
	Overlay Plane	Not used	N/A
	Modality LUT	Not used	N/A
	VOI LUT	Used < Need to specify when>	0
	SOP Common	Used	4.4.5.8

7.4 INFORMATION MODULE DEFINITIONS

Please refer to DICOM Standard Part 3 (Information Object Definitions) for a description of each of the entities and modules contained within the SC Information Object.

The following modules are included to convey Enumerated Values, Defined Terms, and Optional Attributes supported. Type 1 & Type 2 Attributes are also included for completeness and to define what values they may take and where these values are obtained from when generating the instance. It should be noted that they are the same ones as defined in the DICOM Standard Part 3 (Information Object Definitions). Also note that Attributes not present in tables are not supported.

7.4.1 Equipment Entity Modules

7.4.1.1 SC Equipment Module

TABLE 7-3
SC EQUIPMENT MODULE ATTRIBUTES

Attribute Name	Tag	Type	Use
Conversion Type	(0008,0064)	1	Set to "WSD"
Modality	(0008,0060)	3	Defined Value "US" used. When reading SC all modalities are accepted
Secondary Capture Device ID	(0018,1010)	3	Defined Value "LOGIQE8"
Secondary Capture Device Manufacturer	(0018,1016)	3	Implementation defined string "GE Healthcare"
Secondary Capture Device Manufacturer's Model Name	(0018,1018)	3	Implementation defined string "LOGIQE8"

DIR DOC1585895 REV 2

Secondary Capture Device Software Version	(0018,1019)	3	Is set to LOGIQ E8 software version
---	-------------	---	-------------------------------------

7.4.2 Image Entity Modules

7.4.2.1 SC Image Module

TABLE 7-4
SC IMAGE MODULE ATTRIBUTES

Attribute Name	Tag	Type	Use
Date of Secondary Capture	(0018,1012)	3	Image capture date
Time of Secondary Capture	(0018,1014)	3	Image capture time

8. COMPREHENSIVE STRUCTURED REPORT INFORMATION OBJECT IMPLEMENTATION

8.1 INTRODUCTION

This section specifies the use of the DICOM Comprehensive SR IOD to represent results produced by this implementation. Corresponding attributes are conveyed using the module construct.

8.2 LOGIQ E8 MAPPING OF DICOM ENTITIES

The LOGIQ E8 maps DICOM Information Entities to local Information Entities in the product's database and user interface.

TABLE 8-1
MAPPING OF DICOM ENTITIES TO LOGIQ E8 ENTITIES

DICOM IE	LOGIQ E8 Entity
Patient	Patient
Study	Exam
Series	Series
Document	Document

8.3 IOD MODULE TABLE

The Comprehensive Structured Report Information Object Definitions comprise the modules of the following tables, plus Standard Extended and Private attributes. Standard Extended and Private attributes are described in Section 8.5. The elements not listed are not used by the application.

The contents of the SR Document Content are constrained by the supported template, as identified in Section 8.4.2.2.1.1. Standard, Standard Extended and Private templates are further described in Section 8.7.

TABLE 8-2
STRUCTURE REPORT IOD MODULES

Entity Name	Module Name	Usage	Reference
Patient	Patient	Used	4.4.1.1
	Specimen Identification	Not used	N/A
	Clinical Trial Subject	Not used	N/A
Study	General Study	Used	4.4.2.1
	Patient Study	Used	4.4.2.2
	Clinical Trial Study	Not used	N/A
Series	SR Document Series	Used	8.4.1.1
	Clinical Trial Series	Not used	N/A
Equipment	General Equipment	Used	4.4.4.1
Document	SR Document General	Used	8.4.2.1
	SR Document Content	Used	8.4.2.2

	SOP Common	Used	4.4.5.8
--	------------	------	---------

8.4 INFORMATION MODULE DEFINITIONS

Please refer to DICOM Part 3 (Information Object Definitions) for a description of each of the entities, modules, and attributes contained within the SR Information Objects.

The following modules are included to convey Enumerated Values, Defined Terms, and Optional Attributes supported. Type 1 & Type 2 Attributes are also included for completeness and to define what values they may take and where these values are obtained from when generating the instance. It should be noted that they are the same ones as defined in the DICOM Standard Part 3 (Information Object Definitions). Also note that Attributes not present in tables are not supported.

8.4.1 Series Entity Modules

8.4.1.1 SR Document Series Module

TABLE 8-3
SR DOCUMENT SERIES MODULE ATTRIBUTES

Attribute Name	Tag	Type	Use
Modality	(0008,0060)	1	Value = SR
Series Instance UID	(0020,000E)	1	Uniquely generated by the equipment
Series Number	(0020,0011)	1	Internal number which is incremented for each new exam within a study.
Referenced Performed Procedure Step Sequence	(0008,1111)	2	Sent as empty.
> <i>Referenced SOP Class / Instance UIDs</i>			

8.4.2 Document Entity Modules

8.4.2.1 SR Document General Module

TABLE 8-4
SR DOCUMENT GENERAL MODULE ATTRIBUTES

Attribute Name	Tag	Type	Use
Instance Number	(0020,0013)	1	Internal number which is incremented for each new SR document within a study.
Completion Flag	(0040,A491)	1	Defined Term "PARTIAL" used.
Verification Flag	(0040,A493)	1	Defined Term "UNVERIFIED" used.
Content Date	(0008,0023)	1	Date of creation, based upon user action that invoked the use of the object
Content Time	(0008,0033)	1	Time of creation, based upon user action that invoked the use of the object.
Referenced Request Sequence	(0040,A370)	1C	Filled in if the exam is based on a Worklist entry
>Study Instance UID	(0020,000D)	1	Taken from Study Instance UID in General Study Module
>Referenced Study Sequence	(0008,1110)	2	Sent as empty.

>>Include 'SOP Instance Reference Macro'			
>Accession Number	(0008,0050)	2	Taken from Accession Number in General Study Module
>Placer Order Number/Imaging Service Request	(0040,2016)	2	Sent as empty.
>Filler Order Number/Imaging Service Request	(0040,2017)	2	Sent as empty.
>Requested Procedure ID	(0040,1001)	2	Taken from worklist if it is there
>Requested Procedure Description	(0032,1060)	2	Taken from worklist if it is there
>Requested Procedure Code Sequence	(0032,1064)	2	Sent as empty.
>>Include 'Code Sequence Macro'			
Performed Procedure Code Sequence	(0040,A372)	2	Sent as empty.
>Include 'Code Sequence Macro'			

8.4.2.2 SR Document Content Module

TABLE 8-5
SR DOCUMENT CONTENT MODULE ATTRIBUTES

Attribute Name	Tag	Type	Use
Observation DateTime	(0040,A032)	1C	Not used

Content Template Sequence	(0040,A504)	1C	Depending on application, see template	
			Application	Template ID
			Small Parts	GEMS_US_0100 Ultrasound M&A document title (99GEMS)
			Pediatrics	GEMS_US_0100 Ultrasound M&A document title (99GEMS)
			Urology	GEMS_US_0100 Ultrasound M&A document title (99GEMS)
			Vascular	5100 Vascular US Proc Rep (DCMR)
			Abdomen	5100 Vascular US Proc Rep (DCMR)
			OB	5000 OB-GYN US Proc Rep (DCMR)
			GYN	5000 OB-GYN US Proc Rep (DCMR)
			Cardiac	5200 Echocardiography Proc Rep (DCMR)
			Thyroid	GEMS_US_SP_0100 Soft Tissue Neck and Head Imaging Report (99GEMS)
Breast	4200 Breast Imaging Report (DCMR)			
			For flagging images rejected with quality reasons: Template ID: 2010 - Key Object Selection (DCMR)	
>Mapping Resource	(0008,0105)	1		
>Template Identifier	(0040,DB00)	1		
Value Type	(0040,A040)	1	CONTAINER	
Continuity of Content	(0040,A050)	1C	SEPARATE	
Concept Name Code Sequence	(0040,A043)	1C	Depending on application, see template	
			<ul style="list-style-type: none"> 'Ultrasound M&A document title' (GEMS_US_0100) 'OB-GYN Ultrasound Procedure Report' 'Vascular Ultrasound Procedure Report' or 'Echocardiography Procedure Report' 'Breast Imaging Report' 'Soft Tissue Neck and Head Imaging Report' 	
			For flagging images which are rejected or deleted during direct store (in progress sending): (113001, DCM, 'Rejected for Quality Reasons')	

<i>>Include 'Code Sequence Macro'</i>			
<i>Insert Concept Value attribute(s)</i>			
Content Sequence	(0040,A730)	1C	Depending on application, see template 'Ultrasound M&A document title' 'OB-GYN Ultrasound Procedure Report' 'Vascular Ultrasound Procedure Report' or 'Echocardiography Procedure Report' 'Breast Imaging Report' 'Soft Tissue Neck and Head Imaging Report' For flagging images see 'Key Object Selection'
> Relationship Type	(0040,A010)	1	Depending on application, see template 'Ultrasound M&A document title', 'OB-GYN Ultrasound Procedure Report', 'Vascular Ultrasound Procedure Report' or 'Echocardiography Procedure Report'. 'Breast Imaging Report' 'Soft Tissue Neck and Head Imaging Report' For flagging images see 'Key Object Selection'
> Referenced Content Item Identifier	(0040,DB73)	1C	Not used
<i>> Insert SR DocumentContent Module</i>			Depending on application, see template 'Ultrasound M&A document title', 'OB-GYN Ultrasound Procedure Report', 'Vascular Ultrasound Procedure Report' or 'Echocardiography Procedure Report'. 'Breast Imaging Report' 'Soft Tissue Neck and Head Imaging Report' For flagging images see 'Key Object Selection'

8.4.2.2.1 SR Document Content Descriptions

8.4.2.2.1.1 Content Template

The product supports the following root Templates for SR SOP Instances created, processed, or displayed by the product.

TABLE 8-6
SR ROOT TEMPLATES

SOP Class	Template ID	Template Name	Use
-----------	-------------	---------------	-----

Comprehensive SR	GEMS_US_010 0	Ultrasound M&A document title	Create
Comprehensive SR	5000	OB-GYN Ultrasound Procedure Report	Create
Comprehensive SR	5100	Vascular Ultrasound Procedure Report	Create
Comprehensive SR	5200	Echocardiography Procedure Report	Create
Comprehensive SR	4200	Breast Imaging Report	Create
Comprehensive SR	GEMS_US_SP_ 0100	Soft Tissue Neck and Head Imaging Report'	Create
Key Object Selection Document	2010	Key Object Selection Document	Create

Refer to section 8.7 for a detailed description of the supported templates.

8.5 STANDARD EXTENDED AND PRIVATE DATA ATTRIBUTES

The product will send measurements raw data information in private data elements designated by the Private Creator element:

Element Name	Tag	VR	VM	Description
Private Creator	6005,00xx	LO	1	GE_GROUP

This means that all private tags starting with 6005,xx will belong to the GE_GROUP.

8.6 STANDARD EXTENDED AND PRIVATE CONTEXT GROUPS

The Product supports coded terminology using Standard Extended, Private, and Configurable Context Groups defined in the following sections.

DICOM SR Templates

Vascular Ultrasound Procedure Report

Echocardiography Procedure Report

OB-GYN Ultrasound Procedure Report

Breast Imaging Report

Soft tissue neck and head Imaging Report

GE Ultrasound M&A Report

8.7 STANDARD, STANDARD EXTENDED AND PRIVATE TEMPLATES

The Product supports the Standard Extended and Private Templates defined in the following sections.

8.7.1 Standard Templates

The Product supports the following standard templates for SOP Instances created by this product.

Application	Template ID
Vascular	5100 Vascular US Proc Rep (DCMR)
Abdomen	5100 Vascular US Proc Rep (DCMR)
OB	5000 OB-GYN US Proc Rep (DCMR)
GYN	5000 OB-GYN US Proc Rep (DCMR)
Cardiac	5200 Echocardiography Proc Rep (DCMR)
Breast	4200 Breast Imaging Report (DCMR)

8.7.2 Standard Extended Templates

Not applicable

DIR DOC1585895 REV 2

8.7.3 Private Templates

The Product supports the following private templates for SOP Instances created by this product.

Application	Template ID
Small Parts	GEMS_US_0100 Ultrasound M&A document title (99GEMS)
Pediatrics	GEMS_US_0100 Ultrasound M&A document title (99GEMS)
Urology	GEMS_US_0100 Ultrasound M&A document title (99GEMS)
Thyroid	GEMS_US_SP_0100 Soft Tissue Neck and Head Imaging Report (99GEMS)

9. KEY OBJECT SELECTION DOCUMENT INFORMATION OBJECT IMPLEMENTATION

9.1 INTRODUCTION

This section specifies the use of the DICOM key Object Selection Document IOD to represent results produced by this implementation. Corresponding attributes are conveyed using the module construct. Use of Key Object Selection is limited to identification of images rejected for quality reasons.

Note: This use is in accordance with Image Object Change Management Profile specified by IHE Radiology."

9.2 LOGIQ E8 MAPPING OF DICOM ENTITIES

The LOGIQ E8 maps DICOM Information Entities to local Information Entities in the product's database and user interface.

TABLE 9-1
MAPPING OF DICOM ENTITIES TO LOGIQ E8 ENTITIES

DICOM IE	LOGIQ E8 Entity
Patient	Patient
Study	Exam
Series	Series
Document	Document

9.3 IOD MODULE TABLE

The Key Object Selection Document Information Object Definitions comprise the modules of the following tables. The elements not listed are not used by the application.

Standard, Standard Extended and Private templates are further described in Section 9.5.

TABLE 9-2
KEY OBJECT SELECTION DOCUMENT IOD MODULES

Entity Name	Module Name	Usage	Reference
Patient	Patient	Used	4.4.1.1
	Specimen Identification	Not used	N/A
	Clinical Trial Subject	Not used	N/A
Study	General Study	Used	4.4.2.1
	Patient Study	Used	4.4.2.2
	Clinical Trial Study	Not used	N/A
Series	Key Object Document Series	Used	9.4.1.1
	Clinical Trial Series	Not used	N/A
Equipment	General Equipment	Used	4.4.3.1

Document	Key Object Document	Used	9.4.2.1
	SR Document Content	Used	8.4.2.2
	SOP Common	Used	4.4.5.8

9.4 INFORMATION MODULE DEFINITIONS

Please refer to DICOM Part 3 (Information Object Definitions) for a description of each of the entities, modules, and attributes contained within the SR Information Objects.

The following modules are included to convey Enumerated Values, Defined Terms, and Optional Attributes supported. Type 1 & Type 2 Attributes are also included for completeness and to define what values they may take and where these values are obtained from when generating the instance. It should be noted that they are the same ones as defined in the DICOM Standard Part 3 (Information Object Definitions). Also note that Attributes not present in tables are not supported.

9.4.1 Series Entity Modules

9.4.1.1 Key Object Document Series Module

TABLE 9-3
KEY OBJECT DOCUMENT SERIES MODULE ATTRIBUTES

Attribute Name	Tag	Type	Use
Modality	(0008,0060)	1	Value = KO
Series Instance UID	(0020,000E)	1	Uniquely generated by the equipment
Series Number	(0020,0011)	1	Internal number which is incremented for each new exam within a study.
Series Date	(0008,0021)	3	Set as date of exam (series) created
Series Time	(0008,0031)	3	Set as time of exam (series) created
Referenced Performed Procedure Step Sequence	(0008,1111)	2	Sent as empty.
> <i>'Referenced SOP Class / Instance UIDs'</i>			

9.4.2 Document Entity Modules

9.4.2.1 Key Object Document Module

TABLE 9-4
KEY OBJECT DOCUMENT MODULE ATTRIBUTES

Attribute Name	Tag	Type	Use
Instance Number	(0020,0013)	1	Internal number which is incremented for each new Key Object Selection document within a study.
Content Date	(0008,0023)	1	Date of creation, based upon user action that invoked the use of the object
Content Time	(0008,0033)	1	Time of creation, based upon user action that invoked the use of the object.
Referenced Request Sequence	(0040,A370)	1C	Filled in if the exam is based on a Worklist entry

>Study Instance UID	(0020,000D)	1	Taken from Study Instance UID in General Study Module
>Referenced Study Sequence	(0008,1110)	2	Sent as empty
>>Include 'SOP Instance Reference Macro'			
>Accession Number	(0008,0050)	2	Taken from Accession Number in General Study Module
>Placer Order Number/Imaging Service Request	(0040,2016)	2	Sent as empty
>Filler Order Number/Imaging Service Request	(0040,2017)	2	Sent as empty
>Requested Procedure ID	(0040,1001)	2	Taken from worklist if it is there
>Requested Procedure Description	(0032,1060)	2	Taken from worklist if it is there
>Requested Procedure Code Sequence	(0032,1064)	2	Sent as empty.
>>Include 'Code Sequence Macro'			
Current Requested Procedure Evidence Sequence	(0040,A375)	1	List of all composite SOP Instances of US Single, US MF, Enhanced US Volume or Secondary Capture referenced in the Content Sequence (0040,A730).
>Include 'Hierarchical SOP Instance Reference Macro'			

9.5 STANDARD, STANDARD EXTENDED AND PRIVATE TEMPLATES

The Product supports the Standard Extended and Private Templates defined in the following sections.

9.5.1 Standard Templates

The Product supports the following standard templates for SOP Instances created by this product.

9.5.1.1 Template ID 2010 Key Object Selection

Please refer following section.

Key Object Selection Document Template

9.5.2 Standard Extended Templates

Not applicable

9.5.3 Private Templates

Not applicable.

10. MODALITY WORKLIST INFORMATION MODEL DEFINITION

10.1 INTRODUCTION

This section specifies the use of the DICOM Modality Worklist Information Model used to organize data and against which a Modality Worklist Query will be performed. The contents of this section are:

10.2- Information Model Description

10.3- Information Model Entity-Relationship Model

10.4- Information Model Module Table

10.5- Information Model Keys

10.2 MODALITY WORKLIST INFORMATION MODEL DESCRIPTION

This section defines the implementation of Modality Worklist Information Model.

10.3 MODALITY WORKLIST INFORMATION MODEL ENTITY-RELATIONSHIP MODEL

The Entity-Relationship diagram for the Modality Worklist Information Model schema is shown in Illustration 10.3-1. It represents the information that composes a Worklist Item. In this figure, the following diagrammatic convention is established to represent the information organization:

- Each entity is represented by a rectangular box.
- Each relationship is represented by a diamond shaped box.
- The fact that a relationship exists between two entities is depicted by lines connecting the corresponding entity boxes to the relationship boxes.

ILLUSTRATION 10.3-1
MODALITY WORKLIST INFORMATION MODEL E/R DIAGRAM

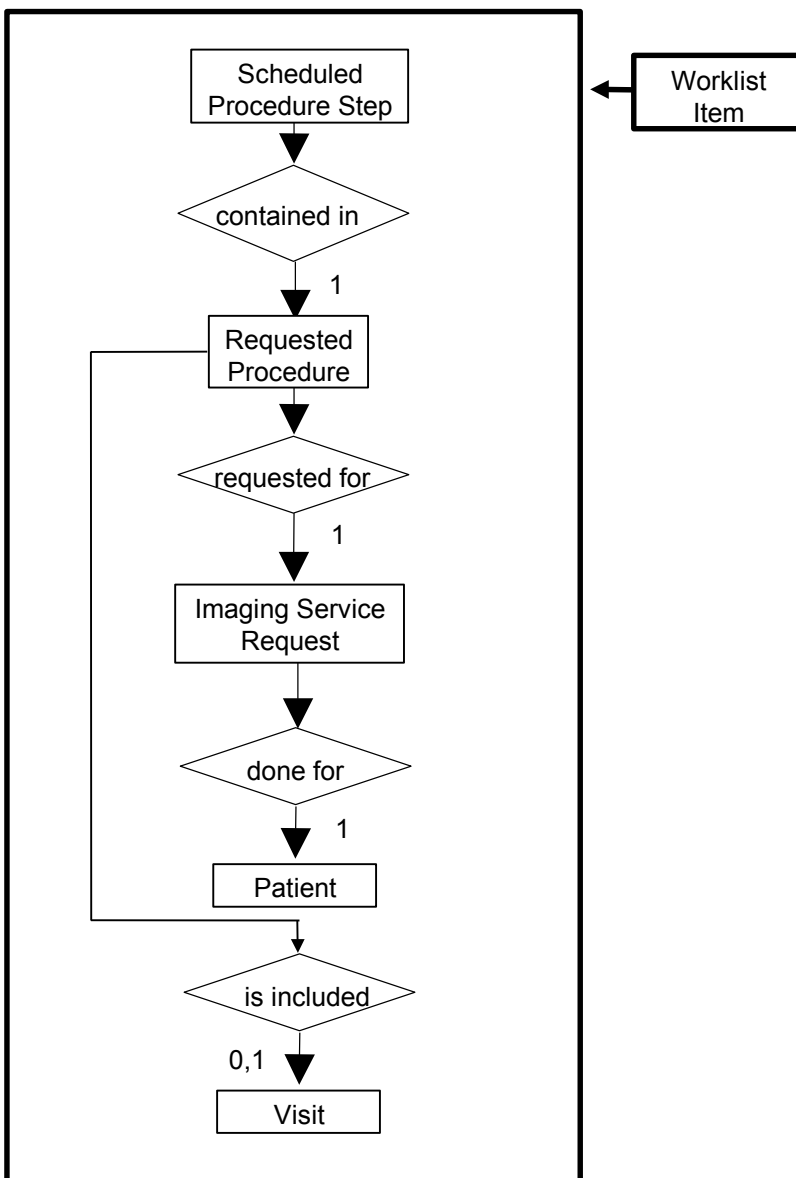

10.3.1 Entity Descriptions

Please refer to DICOM Standard PS 3.3. (Information Object Definitions) and PS 3.4 (Service Class Specifications) for a description of each of the Entities contained within the Modality Worklist Information Model.

10.3.1.1 Scheduled Procedure Step

Schedule Procedure Step is implemented in a basic form to allow for the user to retrieve a subset of attributes.

10.3.1.2 Requested Procedure Entity Description

Requested Procedure Step is implemented in a basic form to allow for the user to retrieve a subset of attributes.

DIR DOC1585895 REV 2

10.3.1.3 Imaging Service Request Entity Description

Image Service is implemented in a basic form to allow for the user to retrieve a subset of attributes.

10.3.1.4 Visit Entity Description

Visit Entity is implemented in a basic form to allow for the user to retrieve a subset of attributes.

10.3.1.5 Patient Entity Description

Patient Entity Description is implemented in a basic form to allow for the user to retrieve a subset of attributes.

10.3.2 LOGIQ E8 Mapping of DICOM entities**TABLE 10-1 MAPPING OF DICOM ENTITIES TO LOGIQ E8 ENTITIES**

DICOM	LOGIQ E8 Entity
Scheduled Procedure Step	Worklist entry
Requested Procedure	Exam
Imaging Service Request	Exam
Visit	Not Applicable
Patient	Patient

10.4 INFORMATION MODEL MODULE TABLE

Within an entity of the DICOM Modality Worklist Information Model, attributes are grouped into related set of attributes. A set of related attributes is termed a module. A module facilitates the understanding of the semantics concerning the attributes and how the attributes are related with each other. A module grouping does not infer any encoding of information into datasets.

Table 10-2 identifies the defined modules within the entities that comprise the DICOM Modality Worklist Information Model. Modules are identified by Module Name.

See DICOM PS 3.3 and PS 3.4 for a complete definition of the entities, modules, and attributes.

TABLE 10-2 MODALITY WORKLIST INFORMATION MODEL MODULES

Entity Name	Module Name	Reference
Scheduled Procedure Step	SOP Common	10.5.2.1
	Scheduled Procedure Step	10.5.2.2
Requested Procedure	Requested Procedure	10.5.3.1
Imaging Service Request	Imaging Service Request	10.5.4.1
Visit	Visit Identification	10.5.5.1
	Visit Status	10.5.5.2
	Visit Relationship	10.5.5.3
	Visit Admission	Not Used
Patient	Patient Relationship	Not Used
	Patient Identification	10.5.6.1
	Patient Demographic	10.5.6.2
	Patient Medical	10.5.6.3

10.5 INFORMATION MODEL KEYS

Please refer to DICOM Standard PS 3.3. (Information Object Definitions) and PS 3.4 (Service Class Specifications) for a description of each of the Entities contained within the Modality Worklist Information Model.

The following Module descriptions are included to specify what data elements are supported and what type of matching can be applied. It should be noted that they are the same ones as defined in the DICOM Standard PS 3.4 (Service Class Specifications).

The term Instance is used for Images and Results in examinations that are based on Worklist entries. Please note that tags that are not defined for SR documents will not be mapped (see Section: 8).

10.5.1 Supported Matching

Following are the types of matching that can be requested by the implementation:

- Single Value Matching.
- Wild Card Matching.
- Range of date.

Fields with “Filtering is supported” in the Matching column can be controlled from the Search screen. This means that the user can filter the downloaded C-FIND result, to view a limited set of the result.

All non-required matching fields can be configured in Config screen to be either enabled, enabled with a constant value or disabled. The constant value will be used as entered by user.

Wild Card Matching is only used for Patient’s Name (0010,0010).

DIR DOC1585895 REV 2

10.5.2 Scheduled Procedure Step Entity**10.5.2.1 SOP Common Module****TABLE 10-3 SOP COMMON MODULE ATTRIBUTES**

Attribute Name	Tag	Expected Matching Key Type	Expected Returned Key Type	Mapped into Instance/MP PS	Matching
Specific Character Set	(0008,0005)	O	1C	Yes/Yes	Attribute is supported if the query contains matching keys in other than the default character repertoire. ISO_IR 100 is supported in responses.

10.5.2.2 Scheduled Procedure Step Module**TABLE 10-4 SCHEDULED PROCEDURE STEP MODULE ATTRIBUTES**

Attribute Name	Tag	Expected Matching Key Type	Expected Returned Key Type	Mapped into Instance/MP PS	Matching
Scheduled Procedure Step Sequence	(0040,0100)	R	1	No/No	Matching is supported.
>Scheduled Station AE Title	(0040,0001)	R	1	No/No	Matching is supported. Filtering is supported.
>Scheduled Procedure Step Start Date	(0040,0002)	R	1	No/No	Matching is supported. Filtering is supported.
>Scheduled Procedure Step Start Time	(0040,0003)	R	1	No/No	Matching is supported. Filtering is supported.
>Modality	(0008,0060)	R	1	Yes/Yes (but always "US")	Matching is supported. Filtering is supported.
>Scheduled Performing Physician's Name	(0040,0006)	R	2	Yes/Yes (to Performing Physician's Name)	Matching is supported. Filtering is supported.
>Scheduled Procedure Step Description	(0040,0007)	O	1C	Yes/Yes	Matching is supported. Filtering is supported.
>Scheduled Station Name	(0040,0010)	O	2	No/No	Matching is supported. Filtering is supported.

>Scheduled Procedure Step Location	(0040,0011)	O	2	No/No	Matching is supported.
>Scheduled Procedure Step ID	(0040,0009)	O	1	Yes/Yes	Matching is supported. Filtering is supported.
>Scheduled Protocol Code Sequence	(0040,0008)	O	1C	Yes/Yes	Matching is supported. Filtering is supported.

10.5.3 Requested Procedure Entity

10.5.3.1 Requested Procedure Module

TABLE 10-5 REQUESTED PROCEDURE MODULE ATTRIBUTES

Attribute Name	Tag	Expected Matching Key Type	Expected Returned Key Type	Mapped into Instance/MPPS	Matching
Requested Procedure ID	(0040,1001)	O	1	Yes/Yes (to Requested Procedure ID and Study ID)	Matching is supported. Filtering is supported.
Requested Procedure Description	(0032,1060)	O	1C	Yes/Yes (to Study Description)	Matching is supported. Filtering is supported.
Requested Procedure Code Sequence	(0032,1064)	O	1C	No/Yes (to Procedure Code Sequence)	Matching is supported. Filtering is supported.
Requested Procedure Comments	(0040,1400)	O	3	No/No	Matching is supported. Filtering is supported.
Study Instance UID	(0020,000D)	O	1	Yes/Yes	Matching is supported. Filtering is supported.
Referenced Study Sequence	(0008,1110)	O	2	Yes/Yes	Matching is supported. Filtering is supported.
>Referenced SOP Class UID	(0008,1150)	O	1C	Yes/Yes	Matching is supported.
>Referenced SOP Instance UID	(0008,1155)	O	1C	Yes/Yes	Matching is supported.
Names of Intended Recipients of Results	(0040,1010)	O	3	No/No (to Physician(s) of Record)	Matching is supported. Filtering is supported.

DIR DOC1585895 REV 2

10.5.4 Imaging Service Request Entity**10.5.4.1 Imaging Service Request Module****TABLE 10-6 IMAGING SERVICE REQUEST MODULE ATTRIBUTES**

Attribute Name	Tag	Expected Matching Key Type	Expected Returned Key Type	Mapped into Instance/MP PS	Matching
Accession Number	(0008,0050)	O	2	Yes/Yes	Matching is supported. Filtering is supported.
Referring Physician's Name	(0008,0090)	O	2	Yes/No	Matching is supported. Filtering is supported.
Imaging Service Request Comments	(0040,2400)	O	3	No/No	Matching is supported. Filtering is supported.
Requesting Physician	(0032,1032)	O	2	No/No	Matching is supported. Filtering is supported.
Requesting Service	(0032,1033)	O	3	No/No	Matching is supported. Filtering is supported.

10.5.5 Visit Entity**10.5.5.1 Visit Identification****TABLE 10-7 VISIT IDENTIFICATION MODULE ATTRIBUTES**

Attribute Name	Tag	Expected Matching Key Type	Expected Returned Key Type	Mapped into Instance/MP PS	Matching
Admission ID	(0038,0010)	O	2	No/Yes	Matching is supported. Filtering is supported.

10.5.5.2 Visit Status**TABLE 10-8 VISIT STATUS MODULE ATTRIBUTES**

Attribute Name	Tag	Expected Matching Key Type	Expected Returned Key Type	Mapped into Instance/MP PS	Matching
Current Patient Location	(0038,0300)	O	2	No/No	Matching is supported. Filtering is supported.

10.5.5.3 Visit Relationship**TABLE 10-9 VISIT RELATIONSHIP MODULE ATTRIBUTES**

Attribute Name	Tag	Expected Matching Key Type	Expected Returned Key Type	Mapped into Instance/MP PS	Matching
----------------	-----	----------------------------	----------------------------	----------------------------	----------

Referenced Patient Sequence	(0008,1120)	O	2	Yes/Yes	Matching is supported.
>Referenced SOP Class UID	(0008,1150)	O	2	Yes/Yes	Matching is supported.
>Referenced SOP Instance UID	(0008,1155)	O	2	Yes/Yes	Matching is supported.

10.5.6 Patient Entity

10.5.6.1 Patient Identification

TABLE 10-10 PATIENT IDENTIFICATION MODULE ATTRIBUTES

Attribute Name	Tag	Expected Matching Key Type	Expected Returned Key Type	Mapped into Instance/MP PS	Matching
Patient's Name	(0010,0010)	R	1	Yes/Yes	<p>Matching is supported. Filtering is supported.</p> <p>Matching is supported as follows: either no Patient's Name is supplied (universal matching), the patient's last (family) name or first name specified on the worklist screen is supplied, for matching; this is user selectable. Wild card matching is implemented for leading and trailing characters.</p> <p>Patient Name is displayed on the "Worklist Schedule" screen.</p> <p>Application does support matching for Patient Last name and First name component groups. The caret characters (^) will be automatically inserted between the supported component groups.</p>
Patient ID	(0010,0020)	R	1	Yes/Yes	Matching is supported. Filtering is supported.
Other Patient Ids	(0010,1000)	O	3	Yes/No	Matching is supported. Filtering is supported.
Other Patient IDs Sequence	(0010,1002)	O	3	No/No	Not used.

10.5.6.2 Patient Demographic

TABLE 10-11 PATIENT DEMOGRAPHIC MODULE ATTRIBUTES

Attribute Name	Tag	Expected Matching Key Type	Expected Returned Key Type	Mapped into Instance/MP PS	Matching
Patients Birth Date	(0010,0030)	O	2	Yes/Yes	Matching is supported. Filtering is supported.
Patients Birth Time	(0010,0032)	O	3	Yes/No	Matching is supported. Filtering is supported.
Patient's Sex	(0010,0040)	O	2	Yes/Yes	Matching is supported. Filtering is supported.
Patient's Size	(0010,1020)	O	3	Yes/No	Matching is supported. Filtering is supported.
Patient's Weight	(0010,1030)	O	2	Yes/No	Matching is supported. Filtering is supported.
Patient's Address	(0010,1040)	O	3	No/No	Matching is supported.
Ethnic Group	(0010,2160)	O	3	Yes/No	Matching is supported. Filtering is supported.
Patient Comments	(0010,4000)	O	3	Yes/No	Matching is supported. Filtering is supported.

10.5.6.3 Patient Medical

TABLE 10-12 PATIENT MEDICAL MODULE ATTRIBUTES

Attribute Name	Tag	Expected Matching Key Type	Expected Returned Key Type	Mapped into Instance/MP PS	Matching
Additional Patient History	(0010,21B0)	O	3	Yes/No	Matching is supported. Filtering is supported.
Contrast Allergies	(0010,2110)	O	2	No/No	Matching is supported. Filtering is supported.
Medical Alerts	(0010,2000)	O	2	No/No	Matching is supported. Filtering is supported.
Pregnancy Status	(0010,21C0)	O	2	No/No	Matching is supported. Filtering is supported.

11. MODALITY PERFORMED PROCEDURE STEP IMPLEMENTATION

11.1 INTRODUCTION

This section specifies the use of the DICOM Modality Performed Procedure Step information to be communicated to the Hospital/Radiology information system.

This feature works in conjunction with DICOM Modality Worklist feature, if installed. However the conformance of this feature is independent of Modality Worklist feature. For information on conformance of Modality Worklist feature to DICOM standard please refer to the appropriate section in this document.

11.1.1 RELATIONSHIP BETWEEN SCHEDULED AND PERFORMED PROCEDURE STEPS

The scanner supports a one-to-one relationship between Scheduled Procedure Step and PPS and a zero-to-one relationship (aka Unscheduled Case or Acquisition without MWL Data).

11.2 MODALITY PERFORMED PROCEDURE STEP MODULE TABLE

See DICOM PS 3.3 and PS 3.4 for a complete definition of the entities, modules, and attributes.

TABLE 11-1 MODALITY PERFORMED PROCEDURE STEP MODULES

Module Name	Reference
SOP Common	Error! Reference source not found.
Performed Procedure Step Relationship	Error! Reference source not found.
Performed Procedure Step Information	Error! Reference source not found.
Image Acquisition Results	Error! Reference source not found.
Radiation Dose	Not Used
Billing and Material Management Codes	Not Used

DIR DOC1585895 REV 2

11.3 MODALITY PERFORMED PROCEDURE STEP MODULE DEFINITIONS

Please refer to DICOM Standard PS 3.3. (Information Object Definitions) for a description of each of the attributes contained within the Modality Performed Procedure Step Information Object Definition.

11.4 SOP COMMON MODULE**TABLE 11-2 SOP COMMON MODULE ATTRIBUTES**

Attribute Name	Tag	Type for SCU N-CREATE	Type for SCU N-SET	Use
Specific Character Set	(0008,0005)	1C	1C	Not used.

11.5 PERFORMED PROCEDURE STEP RELATIONSHIP MODULE**TABLE 11-3 PERFORMED PROCEDURE STEP RELATIONSHIP MODULE ATTRIBUTES**

Attribute Name	Tag	Type for SCU - N-CREATE	
		Acquisition with MWL Entry	Acquisition without MWL Entry
Scheduled Step Attributes Sequence	(0040,0270)	1, One item sent	1, One item sent
>Study Instance UID	(0020,000D)	1, Copied from SPS	1, Created by scanner
>Referenced Study Sequence	(0008,1110)	2, Copied from SPS. Single item sent.	2, Empty
>>Referenced SOP Class UID	(0008,1150)	1, Copied from SPS.	1, Not sent
>>Referenced SOP Instance UID	(0008,1155)	1, Copied from SPS.	1, Not sent
>Accession Number	(0008,0050)	2, Copied from SPS.	2, Empty
>Placer Order Number/Imaging Service Request	(0040,2016)	3, Not sent.	3, Not sent.
>Filler Order Number/Imaging Service Request	(0040,2017)	3, Not sent.	3, Not sent.
>Requested Procedure ID	(0040,1001)	2, Copied from SPS.	2, Empty
>Requested Procedure Code Sequence	(0032,1064)	3, Not sent.	3, Not sent.

>>Code Value	(0008,0100)	1, Not sent.	1, Not sent.
>>Coding Scheme Designator	(0008,0102)	1, Not sent.	1, Not sent.
>>Code Meaning	(0008,0104)	1, Not sent.	1, Not sent.
>Requested Procedure Description	(0032,1060)	2, Empty	2, Empty
>Scheduled Procedure Step ID	(0040,0009)	2, Copied from SPS.	2, Sent empty.
>Scheduled Procedure Step Description	(0040,0007)	2, Copied from SPS.	2, Sent Empty
>Scheduled Protocol Code Sequence	(0040,0008)	2, Copied from SPS. One item sent.	2, Sent Empty.
>>Code Value	(0008,0100)	1, Copied from SPS.	1, Not sent
>>Coding Scheme Designator	(0008,0102)	1, Copied from SPS.	1, Not sent
>>Coding Scheme Version	(0008,0103)	3, Copied from SPS.	3, Not sent
>>Code Meaning	(0008,0104)	3, Copied from SPS.	3, Not sent
Patient's Name	(0010,0010)	2, Copied from worklist.	2 Created by scanner.
Patient ID	(0010,0020)	2, Copied from worklist.	2, Created by scanner.
Issuer of Patient ID	(0010,0021)	3, Copied from worklist.	3, Not sent
Patient's Birth Date	(0010,0030)	2, Copied from worklist.	2, Created by scanner.
Patient's Sex	(0010,0040)	2, Copied from worklist.	2, Created by scanner.
Referenced Patient Sequence	(0008,1120)	2, Copied from worklist.	2, Empty
>Referenced SOP Class UID	(0008,1150)	1, Copied from worklist.	1, Not sent
>Referenced SOP Instance UID	(0008,1155)	1, Copied from worklist.	1, Not sent
Admission ID	(0038,0010)	3, Not sent	3, Not sent
Issuer of Admission ID	(0038,0011)	3, Not sent	3, Not sent
Service Episode ID	(0038,0060)	3, <Not sent	3, Not sent
Issuer of Service Episode ID	(0038,0061)	3, Not sent	3, Not sent
Service Episode Description	(0038,0062)	3, Not sent	3, Not sent

11.6 PERFORMED PROCEDURE STEP INFORMATION MODULE

TABLE 11-4 PERFORMED PROCEDURE STEP INFORMATION MODULE ATTRIBUTES

Attribute Name	Tag	Type for SCU N-CREATE	Type for SCU N-SET	Use
Performed Procedure Step ID	(0040,0253)	1	-	Supported.
Performed Station AE Title	(0040,0241)	1	-	Supported.
Performed Station Name	(0040,0242)	2	-	Supported.
Performed Location	(0040,0243)	2	-	Supported.
Performed Procedure Step Start Date	(0040,0244)	1	-	Supported.
Performed Procedure Step Start Time	(0040,0245)	1	-	Supported.
Performed Procedure Step Status	(0040,0252)	1	3	Supported.
Performed Procedure Step Description	(0040,0254)	2	3	Supported.
Performed Procedure Type Description	(0040,0255)	2	3	Supported.
Procedure Code Sequence	(0008,1032)	2	3	Supported.
>Code Value	(0008,0100)	1	1	Supported.
>Coding Scheme Designator	(0008,0102)	1	1	Supported.
>Coding Scheme Version	(0008,0103)	3	3	Supported.
>Code Meaning	(0008,0104)	3	3	Supported.
Performed Procedure Step End Date	(0040,0250)	2	3	Supported.
Performed Procedure Step End Time	(0040,0251)	2	3	Supported.
Comments on the Performed Procedure Step	(0040,0280)	3	3	Not sent.
Performed Procedure Step Discontinuation Reason Code Sequence	(0040,0281)	3	3	Not sent.
>Code Value	(0008,0100)	1	1	Not sent.
>Coding Scheme Designator	(0008,0102)	1	1	Not sent.
>Coding Scheme Version	(0008,0103)	3	3	Not sent.
>Code Meaning	(0008,0104)	3	3	Not sent.

11.7 IMAGE ACQUISITION RESULTS MODULE

TABLE 11-5 IMAGE ACQUISITION RESULTS MODULE ATTRIBUTES

Attribute Name	Tag	Type for SCU N-CREATE	Type for SCU N-SET	Use
Modality	(0008,0060)	1	-	Supported.

DIR DOC1585895 REV 2

Study ID	(0020,0010)	2	-	Supported.
Performed Protocol Code Sequence	(0040,0260)	2	3	Supported.
>Code Value	(0008,0100)	1	1	Supported.
>Coding Scheme Designator	(0008,0102)	1	1	Supported.
>Coding Scheme Version	(0008,0103)	3	3	Supported.
>Code Meaning	(0008,0104)	3	3	Supported.
Performed Series Sequence	(0040,0340)	2	3	Supported.
>Performing Physician's Name	(0008,1050)	2	2	Sent empty.
>Protocol Name	(0018,1030)	1	1	Supported.
>Operator's Name	(0008,1070)	2	2	Supported.
>Series Instance UID	(0020,000E)	1	1	Supported.
>Series Description	(0008,103E)	2	2	Sent empty.
>Retrieve AE Title	(0008,0054)	2	2	Sent empty.
> Archive Requested	(0040,A494)	3	3	Not sent.
>Referenced Image Sequence	(0008,1140)	2	2	Supported.
>>Referenced SOP Class UID	(0008,1150)	1	1	Supported.
>>Referenced SOP Instance UID	(0008,1155)	1	1	Supported.
>Referenced Non-Image Composite SOP Instance Sequence	(0040,0220)	2	2	Sent empty.
>>Referenced SOP Class UID	(0008,1150)	1	1	Not sent.
>>Referenced SOP Instance UID	(0008,1155)	1	1	Not sent.

12. STORAGE COMMITMENT PUSH MODEL IMPLEMENTATION

12.1 INTRODUCTION

This section of the DICOM Conformance Statement specifies the Storage Commitment Push Model SOP Class, the optional attributes and service elements supported, the valid range of values for mandatory and optional attributes, and the status code behavior.

12.2 STORAGE COMMITMENT PUSH MODEL SOP CLASS DEFINITION

12.2.1 IOD Description

12.2.1.1 STORAGE COMMITMENT MODULE

TABLE 12-1 STORAGE COMMITMENT MODULE

Attribute Name	Tag	Attribute Description
Transaction UID	(0008,1195)	Uniquely generated by the equipment
Retrieve AE Title	(0008,0054)	Not used
Storage Media File-Set ID	(0088,0130)	Not used
Storage Media File-Set UID	(0088,0140)	Not used
Referenced SOP Sequence	(0008,1199)	Supported
>Referenced SOP Class UID	(0008,1150)	Supported
>Referenced SOP Instance UID	(0008,1155)	Supported
>Retrieve AE Title	(0008,0054)	Not used
>Storage Media File-Set ID	(0088,0130)	Not used
>Storage Media File-Set UID	(0088,0140)	Not used
Failed SOP Sequence	(0008,1198)	Supported
>Referenced SOP Class UID	(0008,1150)	Supported
>Referenced SOP Instance UID	(0008,1155)	Supported
>Failure Reason	(0008,1197)	Supported

12.2.2 DIMSE Service Group

TABLE 12-2

DIMSE Service Element	Usage SCU/SCP
N-EVENT-REPORT	M/M
N-ACTION	M/M

12.2.3 Operations

12.2.3.1 Action Information

TABLE 12-3 STORAGE COMMITMENT REQUEST - ACTION INFORMATION

Action Type Name	Action Type ID	Attribute	Tag	Requirement Type SCU/SCP
Request Storage Commitment	1	Transaction UID	(0008,1195)	1/1
		Storage Media File-Set ID	(0088,0130)	Not used
		Storage Media File-Set UID	(0088,0140)	Not used
		Referenced SOP Sequence	(0008,1199)	1/1
		>Referenced SOP Class UID	(0008,1150)	1/1
		>Referenced SOP Instance UID	(0008,1155)	1/1
		>Storage Media File-Set ID	(0088,0130)	Not used
		>Storage Media File-Set UID	(0088,0140)	Not used

12.2.3.2 Service Class User Behavior

LOGIQ E8 sends the N-ACTION primitive (Storage Commitment Request) after successful exam save to a DICOM Storage SCP.

LOGIQ E8 may request storage commitment for all generated SOP Class UIDs:

TABLE 12-4

SOP Class Name	SOP Class UID
Ultrasound Multi-frame Image Storage	1.2.840.10008.5.1.4.1.1.3.1
Ultrasound Multi-frame Image Storage (Retired)	1.2.840.10008.5.1.4.1.1.3
Ultrasound Image Storage	1.2.840.10008.5.1.4.1.1.6.1
Ultrasound Image Storage (Retired)	1.2.840.10008.5.1.4.1.1.6
Enhanced US Volume Storage	1.2.840.10008.5.1.4.1.1.6.2
Secondary Capture Image Storage	1.2.840.10008.5.1.4.1.1.7
Comprehensive Structured Report	1.2.840.10008.5.1.4.1.1.88.33
Key Object Selection Document	1.2.840.10008.5.1.4.1.1.88.59

The association for the N-ACTION is disconnected after processing the response. Thus, the N-EVENT-REPORT must be sent on a separate association.

The Referenced Study Component Sequence Attribute is not supported.

The Transaction UID is valid for two days. If no answer is received, the request will be removed without warning the user.

The optional Storage Media File-Set ID & UID Attributes in the N-ACTION are not supported.

12.2.4 Notifications

LOGIQ E8 will only listen for an N-EVENT-REPORT from the SCP in a new association on the listen port for Verification and Storage Commitment.

Role Negotiation is supported and expected in the new association requested.

12.2.4.1 Event Information

TABLE 12-5
STORAGE COMMITMENT RESULT - EVENT INFORMATION

Event Type Name	Event Type ID	Attribute	Tag	Requirement Type SCU/SCP
Storage Commitment Request Successful	1	Transaction UID	(0008,1195)	-/1
		Retrieve AE Title	(0008,0054)	Not used
		Storage Media File-Set ID	(0088,0130)	Not used
		Storage Media File-Set UID	(0088,0140)	Not used
		Referenced SOP Sequence	(0008,1199)	-/1
		>Referenced SOP Class UID	(0008,1150)	-/1
		>Referenced SOP Instance UID	(0008,1155)	-/1
		>Retrieve AE Title	(0008,0054)	Not used
		>Storage Media File-Set ID	(0088,0130)	Not used
		>Storage Media File-Set UID	(0088,0140)	Not used
Storage Commitment Request Complete - Failures Exist	2	Transaction UID	(0008,1195)	-/1
		Retrieve AE Title	(0008,0054)	Not used
		Storage Media File-Set ID	(0088,0130)	Not used
		Storage Media File-Set UID	(0088,0140)	Not used
		Referenced SOP Sequence	(0008,1199)	-/1C
		>Referenced SOP Class UID	(0008,1150)	-/1
		>Referenced SOP Instance UID	(0008,1155)	-/1
		>Retrieve AE Title	(0008,0054)	Not used
		>Storage Media File-Set ID	(0088,0130)	Not used
		>Storage Media File-Set UID	(0088,0140)	Not used
		Failed SOP Sequence	(0008,1198)	-/1
		>Referenced SOP Class UID	(0008,1150)	-/1
		>Referenced SOP Instance UID	(0008,1155)	-/1
		>Failure Reason	(0008,1197)	Not used.

12.2.4.2 Service Class User Behavior

Upon receipt of N-EVENT-REPORT request with valid Transaction UID, the request will be removed without warning the user, otherwise the job will be left in the holding queue.

If no N-EVENT-REPORT request is received, the job will be removed without warning the user after two days.

13. BASIC DIRECTORY INFORMATION OBJECT IMPLEMENTATION

13.1 INTRODUCTION

This section specifies the use of the DICOM Basic Directory IOD to represent the information included in directories produced by this implementation. Corresponding attributes are conveyed using the module construct. The contents of this section are:

13.2 - IOD Implementation

13.3 - IOD Entity-Relationship Model

13.4- IOD Module Table

13.5 - IOD Module Definition

13.2 BASIC DIRECTORY IOD IMPLEMENTATION

This section defines the implementation of Basic Directory information object.

13.3 BASIC DIRECTORY ENTITY-RELATIONSHIP MODEL

The Entity-Relationship diagram for the Basic Directory interoperability schema is shown in Illustration 13.3-1. In this figure, the following diagrammatic convention is established to represent the information organization:

- each entity is represented by a rectangular box
- each relationship is represented by a diamond shaped box
- the fact that a relationship exists between two entities is depicted by lines connecting the corresponding entity boxes to the relationship boxes.

13.3.1 LOGIQ E8 Mapping of DICOM entities

TABLE 13-1 MAPPING OF DICOM ENTITIES TO LOGIQ E8 ENTITIES

DICOM	LOGIQ E8
Patient	Patient
Study	Exam
Series	Exam
Image or SR Document	Image or Results

**Illustration 13.3-1
BASIC DIRECTORY ENTITY RELATIONSHIP DIAGRAM**

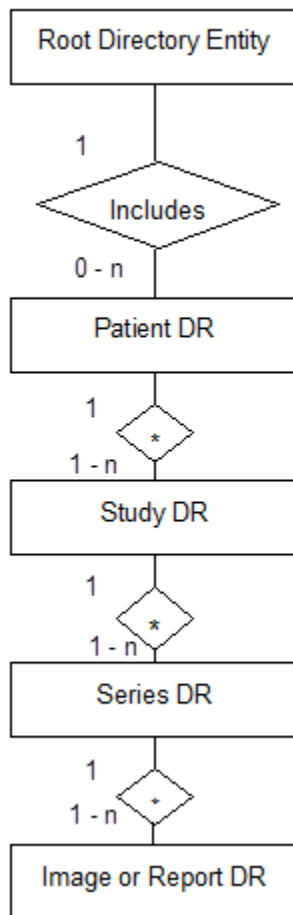

13.4 IOD MODULE TABLE

Within an entity of the Basic Directory IOD, attributes are grouped into related set of attributes. A set of related attributes is termed a module. A module facilitates the understanding of the semantics concerning the attributes and how the attributes are related with each other. A module grouping does not infer any encoding of information into datasets.

Table 13-2 identifies the defined modules within the entities, which comprise the Basic Directory IOD. Modules are identified by Module Name.

See DICOM Part 3 for a complete definition of the entities, modules, and attributes.

TABLE 13-2 BASIC DIRECTORY IOD MODULES

Entity Name	Module Name	Reference
File Set Identification	File Set Identification	13.5.1.1
Directory Information	Directory Information	13.5.2.1

The Directory Information Module is created when initializing the media. If it already exists, the existing information is not changed regarding patient, study, series or image/result data.

DIR DOC1585895 REV 2

An existing Directory Information Module may have been obtained from application entities using removable media. These instances are external to this conformance claim and the origin of the SOP instances is outside the scope of this claim.

13.5 INFORMATION MODULE DEFINITIONS

Please refer to DICOM Standard Part 3 (Information Object Definitions) for a description of each of the entities and modules contained within the Basic Directory Information Object.

The following modules are included to convey Enumerated Values, Defined Terms, and Optional Attributes supported. Type 1 & Type 2 Attributes are also included for completeness and to define what values they may take and where these values are obtained. It should be noted that they are the same ones as defined in the DICOM Standard Part 3 (Information Object Definitions).

13.5.1 Common File Set identification Modules

13.5.1.1 File Set identification Module

TABLE 13-3 FILE-SET IDENTIFICATION MODULE

Attribute Name	Tag	Type	Attribute Description
File-set ID	(0004,1130)	2	Set to empty value.
File-set Descriptor File ID	(0004,1141)	3	Not used
Specific Character Set of File-set Descriptor File	(0004,1142)	1C	Not used

13.5.2 Common Directory Information Modules

13.5.2.1 Directory Information Module

TABLE 13-4 DIRECTORY INFORMATION MODULE

Attribute Name	Tag	Type	Attribute Description
Offset of the First Directory Record of the Root Directory Entity	(0004,1200)	1	Is set
Offset of the Last Directory Record of the Root Directory Entity	(0004,1202)	1	Is set
File-set Consistency Flag	(0004,1212)	1	FSC/FSU/FSR: Has the value 0000H: no known inconsistencies, ignored when reading.
Directory Record Sequence	(0004,1220)	2	Is created by FSC or updated by FSU
>Offset of the Next Directory Record	(0004,1400)	1C	Is set

Attribute Name	Tag	Type	Attribute Description
>Record In-use Flag	(0004,1410)	1C	FSC/FSU: Is set to FFFFH FSR: A value of 0000H: imply skipping this record
>Offset of Referenced Lower-Level Directory Entity	(0004,1420)	1C	Is set
>Directory Record Type	(0004,1430)	1C	The values support by FSC and FSU are PATIENT STUDY SERIES IMAGE
>Private Record UID	(0004,1432)	1C	Not used
>Referenced File ID	(0004,1500)	1C	Is set if Directory Record Type is IMAGE Contains the file path consisting of 5 elements: 1. "GEMS_IMG" (if IMAGE) 2. Month of exam 3. Day of exam 4. Patient initials and time of exam 5. Time stamp
>Referenced SOP Class UID in File	(0004,1510)	1C	Is set to the SOP class UID in File if Directory Record Type is IMAGE
>Referenced SOP Instance UID in File	(0004,1511)	1C	Is set to the SOP instance UID in File if Directory Record Type is IMAGE
>Referenced Transfer Syntax UID in File	(0004,1512)	1C	Is set to the Transfer Syntax UID in File if Directory Record Type is IMAGE
>Record Selection Keys			See 13.5.3.

13.5.3 Definition of Specific Directory Records

13.5.3.1 Patient Directory Record Definition

TABLE 13-5 PATIENT KEYS

Key	Tag	Type	Attribute Description
Specific Character Set	(0008,0005)	1C	Is filled in by FSC and FSU as in chapter 4, 5, 6 and 7.
Patient's Name	(0010,0010)	2	Is filled in by FSC and FSU as in chapter 4, 5, 6 and 7.
Patient ID	(0010,0020)	1	Is filled in by FSC and FSU as in chapter 4, 5, 6 and 7. If empty, a Patient Id is created by the equipment.
Patient's Birth Date	(0010,0030)	2	Is filled in by FSC and FSU as in chapter 4, 5, 6 and 7.
Patient's Sex	(0010,0040)	2	Is filled in by FSC and FSU as in chapter 4, 5, 6 and 7.
Referenced Patient Sequence	(0008,1120)	3	Is filled in by FSC and FSU as in chapter 4, 5, 6 and 7.
>Referenced SOP Class UID	(0008,1150)	3	Is filled in by FSC and FSU as in chapter 4, 5, 6 and 7.
>Referenced SOP Instance UID	(0008,1155)	3	Is filled in by FSC and FSU as in chapter 4, 5, 6 and 7.
Patient's Birth Time	(0010,0032)	3	Is filled in by FSC and FSU as in chapter 4, 5, 6 and 7.
Other Patient Ids	(0010,1000)	3	Is filled in by FSC and FSU as in chapter 4, 5, 6 and 7.
Other Patient Names	(0010,1001)	3	Is filled in by FSC and FSU as in chapter 4, 5, 6 and 7.
Ethnic Group	(0010,2160)	3	Is filled in by FSC and FSU as in chapter 4, 5, 6 and 7.
Patient Comments	(0010,4000)	3	Is filled in by FSC and FSU as in chapter 4, 5, 6 and 7.

13.5.3.2 Study Directory Record Definition

TABLE 13-6 STUDY KEYS

Key	Tag	Type	Attribute Description
Specific Character Set	(0008,0005)	1C	Is filled in by FSC and FSU as in chapter 4, 5, 6 and 7.
Study Instance UID	(0020,000D)	1C	Is filled in by FSC and FSU as in chapter 4, 5, 6 and 7.

Key	Tag	Type	Attribute Description
Study Date	(0008,0020)	1	Is filled in by FSC and FSU as in chapter 4, 5, 6 and 7. If empty, a Study Date is created by the equipment.
Study Time	(0008,0030)	1	Is filled in by FSC and FSU as in chapter 4, 5, 6 and 7. If empty, a Study Time is created by the equipment.
Referring Physician's Name	(0008,0090)	3	Is filled in by FSC and FSU as in chapter 4, 5, 6 and 7.
Study ID	(0020,0010)	1	Is filled in by FSC and FSU as in chapter 4, 5, 6 and 7. If empty, a Study Id is created by the equipment.
Accession Number	(0008,0050)	2	Is filled in by FSC and FSU as in chapter 4, 5, 6 and 7.
Study Description	(0008,1030)	2	Is filled in by FSC and FSU as in chapter 4, 5, 6 and 7.
Physician(s) of Record	(0008,1048)	3	Is filled in by FSC and FSU as in chapter 4, 5, 6 and 7.
Name of Physician(s) Reading Study	(0008,1060)	3	Is filled in by FSC and FSU as in chapter 4, 5, 6 and 7.
Referenced Study Sequence	(0008,1110)	3	Is filled in by FSC and FSU as in chapter 4, 5, 6 and 7.
>Referenced SOP Class UID	(0008,1150)	3	Is filled in by FSC and FSU as in chapter 4, 5, 6 and 7.
>Referenced SOP Instance UID	(0008,1155)	3	Is filled in by FSC and FSU as in chapter 4, 5, 6 and 7.
Admitting Diagnoses Description	(0008,1080)	3	Is filled in by FSC and FSU as in chapter 4, 5, 6 and 7.
Patient's Age	(0010,1010)	3	Is filled in by FSC and FSU as in chapter 4, 5, 6 and 7.
Patient's Size	(0010,1020)	3	Is filled in by FSC and FSU as in chapter 4, 5, 6 and 7.
Patient's Weight	(0010,1030)	3	Is filled in by FSC and FSU as in chapter 4, 5, 6 and 7.

Key	Tag	Type	Attribute Description
Occupation	(0010,2180)	3	Is filled in by FSC and FSU as in chapter 4, 5, 6 and 7.
Additional Patient's History	(0010,21B0)	3	Is filled in by FSC and FSU as in chapter 4, 5, 6 and 7.

13.5.3.3 Series Directory Record Definition

TABLE 13-7 SERIES KEYS

Key	Tag	Type	Attribute Description
Specific Character Set	(0008,0005)	1C	Is filled in by FSC or FSU as contained in the image or SR document message, if one of the tags contains extended characters
Modality	(0008,0060)	1	Is filled in by FSC and FSU as in chapter 4, 5, 6 and 7.
Series Instance UID	(0020,000E)	1	Is filled in by FSC and FSU as in chapter 4, 5, 6 and 7.
Series Number	(0020,0011)	1	Is filled in by FSC and FSU as in chapter 4, 5, 6 and 7. If empty, a Series Number is created by the equipment.
Icon Image Sequence	(0088,0200)	3	Not used.
Series Date	(0008,0021)	3	Is filled in by FSC and FSU as in chapter 4, 5, 6 and 7 if instance is IMAGE.
Series Time	(0008,0031)	3	Is filled in by FSC and FSU as in chapter 4, 5, 6 and 7 if instance is IMAGE.
Performing Physicians' Name	(0008,1050)	3	Is filled in by FSC and FSU as in chapter 4, 5, 6 and 7 if instance is IMAGE.
Protocol Name	(0018,1030)	3	Is filled in by FSC and FSU as in chapter 4, 5, 6 and 7 if instance is IMAGE.
Series Description	(0008,103E)	3	Is filled in by FSC and FSU as in chapter 4, 5, 6 and 7 if instance is IMAGE.

Key	Tag	Type	Attribute Description
Operator's Name	(0008,1070)	3	Is filled in by FSC and FSU as in chapter 4, 5, 6 and 7 if instance is IMAGE.
Referenced Performed Procedure Step Sequence	(0008,1111)	3	Is filled in by FSC and FSU as in chapter 4, 5, 6 and 7.
>Referenced SOP Class UID	(0008,1150)	3	Is filled in by FSC and FSU as in chapter 4, 5, 6 and 7.
>Referenced SOP Instance UID	(0008,1155)	3	Is filled in by FSC and FSU as in chapter 4, 5, 6 and 7.
Request Attributes Sequence	(0040,0275)	3	Is filled in by FSC and FSU as in chapter 4, 5, 6 and 7 if instance is IMAGE.
>Requested Procedure ID	(0040,1001)	3	Is filled in by FSC and FSU as in chapter 4, 5, 6 and 7 if instance is IMAGE.
>Scheduled Procedure Step ID	(0040,0009)	3	Is filled in by FSC and FSU as in chapter 4, 5, 6 and 7 if instance is IMAGE.
>Scheduled Procedure Step Description	(0040,0007)	3	Is filled in by FSC and FSU as in chapter 4, 5, 6 and 7 if instance is IMAGE.
>Scheduled Protocol Code Sequence	(0040,0008)	3	Is filled in by FSC and FSU as in chapter 4, 5, 6 and 7 if instance is IMAGE.
>>Include 'Code Sequence Macro'			Is filled in by FSC and FSU as in chapter 4, 5, 6 and 7 if instance is IMAGE.
Performed Procedure Step ID	(0040,0253)	3	Is filled in by FSC and FSU as in chapter 4, 5, 6 and 7 if instance is IMAGE.
Performed Procedure Step Start Date	(0040,0244)	3	Is filled in by FSC and FSU as in chapter 4, 5, 6 and 7 if instance is IMAGE.
Performed Procedure Step Start Time	(0040,0245)	3	Is filled in by FSC and FSU as in chapter 4, 5, 6 and 7 if instance is IMAGE.
Performed Procedure Step Description	(0040,0254)	3	Is filled in by FSC and FSU as in chapter 4, 5, 6 and 7 if instance is IMAGE.

Key	Tag	Type	Attribute Description
Performed Protocol Code Sequence	(0040,0260)	3	Is filled in by FSC and FSU as in chapter 4, 5, 6 and 7 if instance is IMAGE.
>Include 'Code Sequence Macro'			
Manufacturer	(0008,0070)	3	Is filled in by FSC and FSU as in chapter 4, 5, 6 and 7.
Institution Name	(0008,0080)	3	Is filled in by FSC and FSU as in chapter 4, 5, 6 and 7.
Station Name	(0008,1010)	3	Is filled in by FSC and FSU as in chapter 4, 5, 6 and 7.
Institutional Department Name	(0008,1040)	3	Is filled in by FSC and FSU as in chapter 4, 5, 6 and 7.
Manufacturer's Model Name	(0008,1090)	3	Is filled in by FSC and FSU as in chapter 4, 5, 6 and 7.
Software Versions	(0018,1020)	3	Is filled in by FSC and FSU as in chapter 4, 5, 6 and 7.

13.5.3.4 Image Directory Record Definition

TABLE 13-8 IMAGE KEYS

Key	Tag	Type	Attribute Description
Specific Character Set	(0008,0005)	1C	Is filled in by FSC and FSU as in chapter 4, 5, 6 and 7.
Instance Number	(0020,0013)	1	Is filled in by FSC and FSU as in chapter 4, 5, 6 and 7. If empty, a Instance Number is created by the equipment.
Icon Image Sequence	(0088,0200)	3	Not used
Content Date	(0008,0023)	3	Is filled in by FSC and FSU as in chapter 4, 5, 6 and 7.
Content Time	(0008,0033)	3	Is filled in by FSC and FSU as in chapter 4, 5, 6 and 7.
Image Type	(0008,0008)	3	Is filled in by FSC and FSU as in chapter 4, 5, 6 and 7.
Rows	(0028,0010)	3	Is filled in by FSC and FSU as in chapter 4, 5, 6 and 7.

Columns	(0028,0011)	3	Is filled in by FSC and FSU as in chapter 4, 5, 6 and 7.
Number Of Frames	(0028,0008)	3	Is filled in by FSC and FSU as in chapter 4, 5, 6 and 7.
Photometric Interpretation	(0028,0004)	3	Is filled in by FSC and FSU as in chapter 4, 5, 6 and 7.
Contrast/Bolus Agent	(0018,0010)	3	Is filled in by FSC and FSU as in chapter 4, 5, 6 and 7.
Lossy Image Compression	(0028,2110)	3	Is filled in by FSC and FSU as in chapter 4, 5, 6 and 7.
Lossy Image Compression Ratio	(0028,2112)	3	Is filled in by FSC and FSU as in chapter 4, 5, 6 and 7.

13.5.3.5 Private Directory Record Definition

Not used.

13.6 PRIVATE DATA DICTIONARY

If so configured, the product will send ultrasound raw data information in private data elements designated by the Private Creator element:

TABLE 13-9

Element Name	Tag	VR	VM	Description
Private Creator	7FE1,00xx	LO	1	GEMS_Ultrasound_MovieGroup_001

This means that all private tags starting with 7FE1,xx will belong to the GEMS_Ultrasound_MovieGroup_001.

If so configured, the product will send preview image in private data elements designated by the Private Creator element:

TABLE 13-10

Element Name	Tag	VR	VM	Description
Private Creator	6003,00xx	LO	1	GEMS_Ultrasound_ImageGroup_001

This means that all private tags starting with 6003,xx will belong to the GEMS_Ultrasound_ImageGroup_001.

If so configured, the product will send exam information in private data elements designated by the Private Creator element:

TABLE 13-11

Element Name	Tag	VR	VM	Description
--------------	-----	----	----	-------------

DIR DOC1585895 REV 2

Private Creator	6005,00xx	LO	1	GEMS_Ultrasound_ExamGroup_001
-----------------	-----------	----	---	-------------------------------

This means that all private tags starting with 6005,xx will belong to the GEMS_Ultrasound_ExamGroup_001.

14. PRINT MANAGEMENT IMPLEMENTATION

14.1 INTRODUCTION

This section of the DICOM Conformance Statement specifies the supported Print Management SOP and Meta SOP Classes, the optional attributes and service elements supported, the valid range of values for mandatory and optional attributes, and the status code behavior.

14.2 - Basic Print Management Meta SOP Classes

14.3 - Print Management SOP Class Definitions

14.4 - Print Management IODs

14.5 - IOD Module Definition

14.2 BASIC PRINT MANAGEMENT META SOP CLASSES

The Basic Print Management Meta SOP Classes correspond with the minimum functionality that an implementation of the Print Management Service Class shall support.

LOGIQ E8 supports the Basic Grayscale Print Management Meta SOP Class and the Basic Color Print Management Meta SOP Class. These are defined in Table 14-1 and Table 14-2.

14.2.1 Basic Grayscale Print Management Meta SOP Class

The Basic Grayscale Print Management Meta SOP Class is defined by the following set of supported SOP Classes.

TABLE 14-1
BASIC GRAYSCALE PRINT MANAGEMENT META SOP CLASS

SOP Class Name	Usage SCU	Reference
Basic Film Session SOP Class	M	see 14.3.1
Basic Film Box SOP Class	M	see 14.3.2
Basic Grayscale Image Box SOP Class	M	see 14.3.3.1
Printer SOP Class	M	see 14.3.4
Basic Annotation Box SOP Class	U	See 14.3.5

14.2.2 Basic Color Print Management Meta SOP Class

The Basic Color Print Management Meta SOP Class is defined by the following set of supported SOP Classes

TABLE 14-2
BASIC COLOR PRINT MANAGEMENT META SOP CLASS

SOP Class Name	Usage SCU	Reference
Basic Film Session SOP Class	M	see 14.3.1
Basic Film Box SOP Class	M	see 14.3.2
Basic Color Image Box SOP Class	M	see 14.3.3.2
Printer SOP Class	M	see 14.3.4
Basic Annotation Box SOP Class	U	See 14.3.5

14.3 PRINT MANAGEMENT SOP CLASS DEFINITIONS

14.3.1 Basic Film Session SOP Class

The Basic Film Session IOD describes the presentation parameters, which are common for all the films of a film session. The DIMSE services that are applicable to the IOD are shown in below table

TABLE 14-3
DIMSE SERVICE GROUP

DIMSE Service Element	Usage SCU	Reference
N-CREATE	M	see 14.3.1.1.1
N-SET	U	see 14.3.1.1.2
N-DELETE	U	see 14.3.1.1.3
N-ACTION	U	see 14.3.1.1.4

14.3.1.1 DIMSE Service Group

14.3.1.1.1 N-CREATE

The N-CREATE DIMSE Service is used by LOGIQ E8 to request that the SCP (printer) create a Film Session SOP Instance. Table 14-15 defines the Basic Film Session Presentation Module attributes used in this request.

14.3.1.1.2 N-SET

Not used in this implementation.

14.3.1.1.3 N-DELETE

Not used in this implementation.

14.3.1.1.4 N-ACTION

Not used in this implementation

DIR DOC1585895 REV 2

14.3.2 Basic Film Box SOP Class

The Basic Film Box IOD is an abstraction of the presentation of one film of the film session. The DIMSE services that are applicable to the IOD are shown in below table

TABLE 14-4
DIMSE SERVICE GROUP

DIMSE Service Element	Usage SCU	Reference
N-CREATE	M	see 14.3.2.1.1
N-ACTION	M	see 14.3.2.1.2
N-DELETE	U	see 14.3.2.1.3
N-SET	U	see 14.3.2.1.4

14.3.2.1 DIMSE Service Group**14.3.2.1.1 N-CREATE**

The N-CREATE DIMSE Service is used by LOGIQ E8 to request that the SCP create a Film Box SOP Instance. Table 14-17 defines the Basic Film Box Presentation Module attributes used in this request. The Table 14-18 defines the Basic Film Box Relationship module attributes.

14.3.2.1.2 N-ACTION

The N-ACTION DIMSE Service is used by LOGIQ E8 to request the SCP (printer) to print the number of copies configured by the user to a film of the film session.

14.3.2.1.3 N-DELETE

The N-DELETE DIMSE Service is used by LOGIQ E8 to request the SCP (printer) to delete the complete Film Box. The root Film Box Instance UID is sent to the SCP to accomplish this.

14.3.2.1.4 N-SET

Not used in this implementation.

14.3.3 Image Box SOP Class**14.3.3.1 Basic Grayscale Image Box SOP Class**

The Basic Grayscale Image Box IOD is an abstraction of the presentation of an image and image related data in the image area of a film. The DIMSE services that are applicable to the IOD are shown in below table.

TABLE 14-5
DIMSE SERVICE GROUP

DIMSE Service Element	Usage SCU	Reference
N-SET	M	see 14.3.3.1.1

DIR DOC1585895 REV 2

14.3.3.1.1 DIMSE Service Group (N-SET)

The N-SET DIMSE Service is used by LOGIQ E8 to update the Basic Grayscale Image Box SOP Instance. Table 14-19 defines the Basic Image Box Pixel Presentation Module attributes used.

14.3.3.2 Basic Color Image Box SOP Class

The Basic Color Image Box IOD is an abstraction of the presentation of an image and image related data in the image area of a film. The DIMSE services that are applicable to the IOD are shown in below table

TABLE 14-6
DIMSE SERVICE GROUP

DIMSE Service Element	Usage SCU	Reference
N-SET	M	see 14.3.3.2.1

14.3.3.2.1 DIMSE Service Group (N-SET)

The N-SET DIMSE Service is used by LOGIQ E8 to update the Basic Color Image Box SOP Instance. The Table 14-19B defines the Basic Image Box Pixel Presentation Module attributes used.

14.3.4 Printer SOP Class

The Printer IOD is an abstraction of the hard copy printer and is the basic Information Entity to monitor the status of the printer. The DIMSE services that are applicable to the IOD are shown in below table

14.3.4.1 DIMSE Service Group

TABLE 14-7
DIMSE SERVICE GROUP

DIMSE Service Element	Usage SCU	Reference
N-SET	M	see 14.3.3.2.1

14.3.4.1.1 N-EVENT_REPORT

LOGIQ E8 confirms the N-EVENT-REPORT initiated by the SCP (printer).

14.3.4.1.2 N-GET

Used by LOGIQ E8 to request the SCP to get a Printer SOP Instance. Table 14-20 defines the Printer Module attributes.

14.3.5 Basic Annotation Box SOP Class

The Basic Annotation Box IOD is an abstraction to create an annotation box to print server. The DIMSE services that are applicable to the IOD are shown in below table.

14.3.5.1 DIMSE Service Group

TABLE 14-8
DIMSE SERVICE GROUP

DIMSE Service Element	Usage SCU	Reference
-----------------------	-----------	-----------

N-SET	M	see 14.3.5.1.1
-------	---	----------------

14.3.5.1.1 DIMSE Service Group (N-SET)

The N-SET DIMSE Service is used by LOGIQ E8 to update the Basic Annotation Box SOP Instance. Table 14-21 defines Basic Annotation Presentation Module Attributes used.

14.4 PRINT MANAGEMENT IODS

Within an entity of a DICOM Print Management, attributes are grouped into a related set of attributes. A set of related attributes is termed a module. A module facilitates the understanding of the semantics concerning the attributes and how the attributes are related with each other. A module grouping does not infer any encoding of information into datasets.

Table 14-9, Table 14-10, Table 14-11, Table 14-12 and Table 14-13 identify the defined modules within the entities which comprise the DICOM Print Management Service IODs. Modules are identified by Module Name.

See DICOM for a complete definition of the entities, modules and attributes.

14.4.1 Film Session IOD Module

TABLE 14-9 FILM SESSION IOD MODULES

Module Name	Reference
SOP Common Module	14.5.1.1
Basic Film Session Presentation Module	14.5.2.1
Basic Film Session Relationship Module	14.5.2.2

14.4.2 Basic Film Box IOD Module Table

TABLE 14-10 BASIC FILM BOX IOD MODULES

Module Name	Reference
SOP Common Module	14.5.1.1
Basic Film Box Presentation Module	14.5.2.3
Basic Film Box Relationship Module	14.5.2.4

14.4.3 Basic Image Box IOD Module Table

TABLE 14-11 BASIC IMAGE BOX IOD MODULES

Module Name	Reference
SOP Common Module	14.5.1.1
Image Box Pixel Presentation Module	14.5.2.5

14.4.4 Printer IOD Module Table

TABLE 14-12 PRINTER IOD MODULES

Module Name	Reference
SOP Common Module	14.5.1.1
Printer Module	14.5.2.6

14.4.5 Basic Annotation Box IOD Module Table

TABLE 14-13 BASIC ANNOTATION IOD MODULES

Module Name	Reference
SOP Common Module	14.5.1.1
Basic Annotation Presentation Module	14.5.2.7

14.5 INFORMATION MODULE DEFINITIONS

Please refer to DICOM Standard Part 3 (Information Object Definitions) for a description of each of the entities and modules that comprise the Print Management.

The following modules are included to convey Enumerated Values, Defined Terms, and Optional Attributes supported.

14.5.1 General Modules

14.5.1.1 SOP Common Module

This section defines the attributes that are required for proper functioning and identification of the associated SOP Instances. They do not specify any semantics about the Real-World Object represented by the IOD.

TABLE 14-14 SOP COMMON MODULE ATTRIBUTES

Attribute Name	Tag	Type	Attribute Description
SOP Class UID	(0008,0016)	1	Varies with Module Instance and DIMSE Service being used. 1.2.840.100011.5.1.1.1 (Film Session) 1.2.840.100011.5.1.1.2 (Film Box) 1.2.840.100011.5.1.1.4 (Image Box) 1.2.840.100011.5.1.1.15 (Basic Annotation Box) 1.2.840.100011.5.1.1.14 (Print Job)
SOP Instance UID	(0008,0018)	1	Provided by SCP (printer).
Specific Character Set	(0008,0005)	1C	Not used as expanded or replacement character sets not used.

14.5.2 Print Management Modules

For all user configurable tags with no default, no value will be sent if the tag is not configured.

14.5.2.1 Basic Film Session Presentation Module

This section defines the attributes that are common for all films of a film session. The attributes described in below table apply when the N-CREATE DIMSE service is used.

TABLE 14-15 BASIC FILM SESSION PRESENTATION MODULE ATTRIBUTES

Attribute Name	Tag	USAGE (SCU)	Attribute Description
Number of Copies	(2000,0010)	U	Defined Terms used (user configurable): Default is 1. Max is 99.
Print Priority	(2000,0020)	U	Defined Terms used (user configurable): HIGH, MED, LOW. Default is HIGH.
Medium Type	(2000,0030)	U	Defined Terms used (user configurable): PAPER BLUE FILM CLEAR FILM Default is CLEAR FILM.
Film Destination	(2000,0040)	U	Defined Terms used (user configurable): MAGAZINE - default PROCESSOR
Film Session Label	(2000,0050)	U	User configurable. No default.
Memory Allocation	(2000,0060)	U	Not Used
Owner Id	(2100,0160)	U	Not Used

14.5.2.2 Basic Film Session Relationship Module

TABLE 14-16 BASIC FILM SESSION RELATIONSHIP MODULE ATTRIBUTES

Attribute Name	Tag	USAGE (SCU)	Attribute Description
Referenced Film Box Sequence	(2000,0500)	U	Not used
>Referenced SOP Class UID	(0008,1150)	U	
>Referenced SOP Instance UID	(0008,1155)	U	

14.5.2.3 Basic Film Box Presentation Module

The attributes described in below table apply when the N-CREATE DIMSE service is used.

TABLE 14-17 BASIC FILM BOX PRESENTATION MODULE ATTRIBUTES

Attribute Name	Tag	USAGE (SCU)	Attribute Description
Image Display Format	(2010,0010)	M	Enumerated values used (user configurable): STANDARD\X,Y, where X and Y can take values from 1 to 5. Default is STANDARD\1,1.
Annotation Display Format ID	(2010,0030)	U	Not used.
Film Orientation	(2010,0040)	U	Defined Terms used (user configurable): PORTRAIT - default LANDSCAPE
Film Size ID	(2000,0050)	U	Defined Terms used (user configurable): 8INX10IN - default 10INX12IN 10INX14IN 11INX14IN 14INX14IN 14INX17IN 24CMX24CM 24CMX30CM
Magnification Type	(2010,0060)	U	Defined Terms Used (user configurable): REPLICATE - default BILINEAR CUBIC NONE
Smoothing Type	(2010,0080)	U	Free form text entry field (user configurable) and only sent if Magnification Type is CUBIC. No default
Border Density	(2010,0100)	U	Defined Terms Used (user configurable): BLACK WHITE Default is BLACK.
Empty Image Density	(2010,0110)	U	Defined Terms Used (user configurable): BLACK WHITE Default is WHITE.

Min Density	(2010,0120)	U	User configurable. No default. Max is 999.
Max Density	(2010,0130)	U	User configurable. No default. Max is 999.
Trim	(2010,0140)	U	Enumerated Values Used (user configurable): YES NO Default is NO.
Configuration Information	(2010,0150)	U	User configurable. No default.

14.5.2.4 Basic Film Box Relationship Module

This section defines the attributes that describe the common parameters, which apply for all images on a given sheet of film.

TABLE 14-18 BASIC FILM BOX RELATIONSHIP MODULE ATTRIBUTES

Attribute Name	Tag	USAGE (SCU)	Attribute Description
Referenced Film Session Sequence	(2010,0500)	M	
>Referenced SOP Class UID	(0008,1150)	M	1.2.840.10008.5.1.1.1
>Referenced SOP Instance UID	(0008,1155)	M	Provided by SCP (printer)
Referenced Image Box Sequence	(2010,0510)	U	Used for the subsequent handling of Image Boxes
>Referenced SOP Class UID	(0008,1150)	U	In case of Basic Color ImageBox, SOP class UID 1.2.840.10008.5.1.1.4.1 is used. In case of Basic Grayscale Image Box, SOP class UID 1.2.840.10008.5.1.1.4 is used.
>Referenced SOP Instance UID	(0008,1155)	U	
Referenced Basic Annotation Sequence	(2010,0520)	U	Used. Provided by Printer SCP.
>Referenced SOP Class UID	(0008,1150)	U	Set with Basic Annotation Box SOP Class UID.
>Referenced SOP Instance UID	(0008,1155)	U	Set with Basic Annotation Box SOP Instance UID.

14.5.2.5 Image Box Pixel Presentation Module

The attributes described in below table apply when the DIMSE Service N-SET is used.

The first attributes in the table are used for both grayscale and color printing. The attributes within the sequences are used for each type of printing respectively.

TABLE 14-19 IMAGE BOX PIXEL PRESENTATION MODULE ATTRIBUTES (GRAY SCALE)

Attribute Name	Tag	USAGE (SCU)	Attribute Description
Image Position	(2020,0010)	M	Based on the image display format.
Polarity	(2020,0020)	U	Defined term, NORMAL
Requested Image Size	(2020,0030)	U	Not sent
Basic Grayscale Image Sequence	(2020,0110)	M	
>Samples Per Pixel	(0028,0002)	M	Value = '1'
>Photometric Interpretation	(0028,0004)	M	Defined Term MONOCHROME2 used
>Rows	(0028,0010)	M	Value depends on scanning mode and configuration setup.
>Columns	(0028,0011)	M	Value depends on scanning mode and configuration setup.
>Pixel Aspect Ratio	(0028,0034)	MC	Not used
>Bits Allocated	(0028,0100)	M	Value always = 0008H
>Bits Stored	(0028,0101)	M	Value always = 0008H
>High Bit	(0028,0102)	M	Value always = 0007H
>Pixel Representation	(0028,0103)	M	Defined Value '0' - unsigned integer
>Pixel Data	(7FE0,0010)	M	

TABLE 14-19B IMAGE BOX PIXEL PRESENTATION MODULE ATTRIBUTES (COLOR)

Attribute Name	Tag	USAGE (SCU)	Attribute Description
Image Position	(2020,0010)	M	Based on the image display format.
Polarity	(2020,0020)	U	Defined term, NORMAL
Requested Image Size	(2020,0030)	U	Not sent
Basic Color Image Sequence	(2020,0111)	M	
>Samples Per Pixel	(0028,0002)	M	Value = '3'
>Photometric Interpretation	(0028,0004)	M	Defined Term RGB used
>Rows	(0028,0010)	M	Value depends on scanning mode and configuration setup.
>Columns	(0028,0011)	M	Value depends on scanning mode and configuration setup.
>Pixel Aspect Ratio	(0028,0034)	MC	Not used
>Bits Allocated	(0028,0100)	M	Value always = 0008H
>Bits Stored	(0028,0101)	M	Value always = 0008H
>High Bit	(0028,0102)	M	Value always = 0007H
>Pixel Representation	(0028,0103)	M	Defined Value '0' - unsigned integer
>Pixel Data	(7FE0,0010)	M	
>Planar Configuration	(0028, 0006)	M	0001H, color-by-plane, when Basic Color Image Sequence is set

14.5.2.6 Printer Module

This section defines the attributes that are used to monitor the status of the printer. The attributes described in below table apply when the DIMSE Service N-GET is used.

TABLE 14-20 PRINTER MODULE ATTRIBUTES

Attribute Name	Tag	USAG E (SCU)	Attribute Description
Printer Status	(2110,0010)	U	Used to check the status of the printer before a print operation is started. If the printer status is FAILURE, the print operation is aborted, a message is displayed and the print files reside in the print buffer.
Printer Status Info	(2110,0020)	U	If the "Printer Status" is "FAILURE" then this status information is displayed, and the print files resides in the print buffer.
Printer Name	(2110,0030)	U	Requested, but not used
Manufacturer	(0008,0070)	U	Requested, but not used
Manufacturer Model Name	(0008,1090)	U	Requested, but not used
Device Serial Number	(0018,1000)	U	Requested, but not used
Software Versions	(0018,1020)	U	Requested, but not used
Date Last Calibration	(0018,1200)	U	Requested, but not used
Last Calibration	(0018,1201)	U	Requested, but not used

14.5.2.7 Basic Annotation Presentation Module

This section defines the attributes that are used to set Basic Annotation Box. The attributes describes in below table apply when the DIMSE Service N-SET is used.

TABLE 14-21 BASIC ANNOTATION PRESENTATION MODULE ATTRIBUTES

Attribute Name	Tag	USAG E (SCU)	Attribute Description
Annotation Position	(2030,0010)	U	Supported.
Text String	(2030,0020)	U	Text string containing Patient Id and Patient Name.

15. STUDY ROOT QUERY/RETRIEVE INFORMATION MODEL

15.1 INTRODUCTION

This section specifies the use of the DICOM Study Root Query/Retrieve Model used to organize data and against which a Query/Retrieve will be performed. The contents of this section are:

- 15.2 - Information Model Description
- 15.3 - Information Model Entity-Relationship Model
- 15.4 - Information Model Keys

15.2 STUDY ROOT INFORMATION MODEL DESCRIPTION

This section defines the implementation of Study Root Query/Retrieve Information Model.

15.3 STUDY ROOT INFORMATION MODEL ENTITY-RELATIONSHIP MODEL

The Entity-Relationship diagram for the Study Root Information Model schema is shown in Illustration 15.3-1. In this figure, the following diagrammatic convention is established to represent the information organization:

- each entity is represented by a rectangular box
- each relationship is represented by a diamond shaped box.
- the fact that a relationship exists between two entities is depicted by lines connecting the corresponding entity boxes to the relationship boxes.

The relationships are fully defined with the maximum number of possible entities in the relationship shown. In other words, the relationship between Series and Image can have up to n Images per Series.

ILLUSTRATION 15.3-1
STUDY ROOT QUERY/RETRIEVE INFORMATION MODEL E/R DIAGRAM

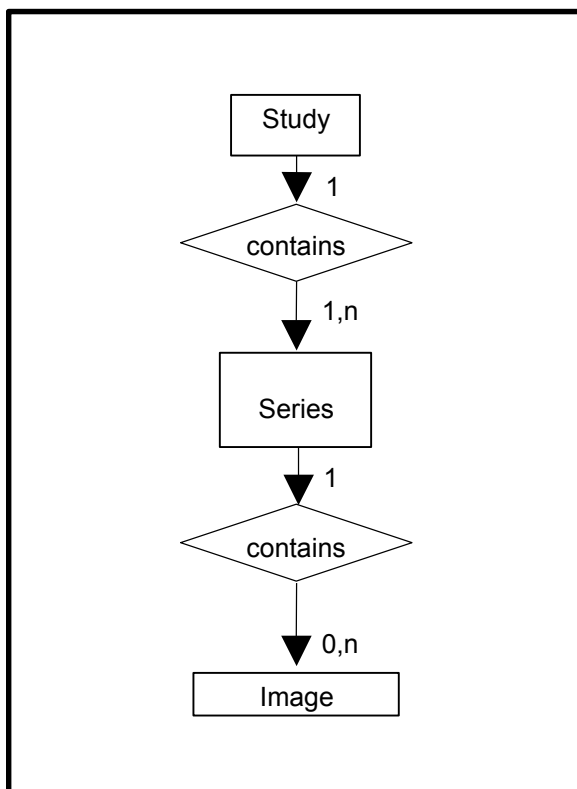

15.3.1 Entity Descriptions

Please refer to DICOM Standard PS 3.4 (Service Class Specifications) for a description of each of the levels contained within the Study Root Query/Retrieve Information Model.

15.3.2 LOGIQ E8 Mapping of DICOM entities

TABLE 15-1
MAPPING OF DICOM ENTITIES TO LOGIQ E8 ENTITIES

DICOM	LOGIQ E8 Entity
Study	Exam
Series	Exam
Image	Image

15.4 INFORMATION MODEL KEYS

Please refer to DICOM Standard PS 3.4 (Service Class Specifications) for a description of each of the levels contained within the Study Root Query/Retrieve Information Model.

The following Level descriptions are included to specify what data elements are supported and what type of matching can be applied. It should be noted that they are the same ones as defined in the DICOM Standard PS 3.4 (Service Class Specifications).

DIR DOC1585895 REV 2

15.4.1 Supported Matching

Following are the types of matching that can be requested by the implementation :

- Single Value matching (S)
- List of UID matching
- Universal Matching (U)
- Wild Card Matching (*)
- Range of date, Range of Time (R)
- Sequence Matching

Fields with “Filtering is supported” in the Matching column can be controlled from the Search screen. This means that the user can filter the downloaded C-FIND result, to view a limited set of the result.

All non-required matching fields can be configured in Config screen to be either enabled, enabled with a constant value or disabled. The constant value will be used as entered by user.

15.4.2 Study Level

This section defines the keys at the Study Level of the Study Root Query/Retrieve Information Model that are supported by this implementation.

TABLE 15-2
STUDY LEVEL ATTRIBUTES FOR THE STUDY ROOT
QUERY/RETRIEVE INFORMATION MODEL

Attribute Name	Tag	Type	Type of Matching
Study Date	(0008,0020)	R	R (Filter is supported)
Study Time	(0008,0030)	R	R
Accession Number	(0008,0050)	R	*, S, U (Filter is supported)
Patient's Name	(0010,0010)	R	*, U (Filter is supported)
Patient ID	(0010,0020)	R	*, U (Filter is supported)
Study ID	(0020,0010)	R	S, *, U
Study Instance UID	(0020,000D)	U	UNIQUE
Modalities in Study	(0008,0061)	O	S, *, U
Referring Physician's Name	(0008,0090)	O	S, *, U
Study Description	(0008,1030)	O	S, *, U (Filter is supported)
Procedure Code Sequence	(0008,1032)	O	U
Name of Physician(s) Reading Study	(0008,1060)	O	U
Admitting Diagnoses Description	(0008,1080)	O	U
Referenced Study Sequence	(0008,1110)	O	U
Referenced Patient Sequence	(0008,1120)	O	U
Patient's Birth Date	(0010,0030)	O	R

Patient's Birth Time	(0010,0032)	O	R
Patient's Sex	(0010,0040)	O	S, U
Other Patient IDs	(0010,1000)	O	U
Other Patient Names	(0010,1001)	O	U
Patient's Age	(0010,1010)	O	U
Patient's Size	(0010,1020)	O	U
Patient's Weight	(0010,1030)	O	U
Ethnic Group	(0010,2160)	O	U
Occupation	(0010,2180)	O	U
Additional Patient History	(0010,21B0)	O	U
Patient Comments	(0010,4000)	O	U
Other Study Numbers	(0020,1070)	O	U
Number of Patient Related Studies	(0020,1200)	O	U
Number of Patient Related Series	(0020,1202)	O	U
Number of Patient Related Instances	(0020,1204)	O	U
Number of Study Related Series	(0020,1206)	O	U
Number of Study Related Instances	(0020,1208)	O	U
Interpretation Author	(4008,010C)	O	U

TABLE 15-3

Q/R STUDY LEVEL AND LOCATION FOR RETRIEVE ATTRIBUTES

Attribute Name	Tag	Type	Note
Query Retrieve Level	(0008,0052)	-	Value = STUDY

TABLE 15-4

Q/R SPECIFIC CHARACTER SET ATTRIBUTES

Attribute Name	Tag	Type	Note
Specific Character Set	(0008,0005)	-	Set to "ISO_IR 100" if extended characters are used in query. ISO_IR 100 is supported in responses.

15.4.3 Series Level

This section defines the keys at the Series Level of the Study Root Query/Retrieve Information Model that are supported by this implementation.

TABLE 15-5

SERIES LEVEL ATTRIBUTES FOR THE STUDY ROOT
QUERY/RETRIEVE INFORMATION MODEL

Attribute Name	Tag	Type	Type of Matching
Modality	(0008,0060)	R	U

Series Number	(0020,0011)	R	U
Series Instance UID	(0020,000E)	U	UNIQUE
Number of Series Related Instances	(0020,1209)	O	U
Series Date	(0008,0021)	O	R
Series Time	(0008,0031)	O	R
Performing Physicians' Name	(0008,1050)	O	U
Protocol Name	(0018,1030)	O	U
Series Description	(0008,103E)	O	U
Operator's Name	(0008,1070)	O	U
Institutional Department Name	(0008,1040)	O	U
Software Versions	(0018,1020)	O	U
Performed Procedure Step Start Date	(0040,0244)	O	R
Performed Procedure Step Start Time	(0040,0245)	O	R

TABLE 15-6

Q/R SERIES LEVEL AND LOCATION FOR RETRIEVE ATTRIBUTES

Attribute Name	Tag	Type	Note
Query Retrieve Level	(0008,0052)	-	Value = SERIES

TABLE 15-7

Q/R SPECIFIC CHARACTER SET ATTRIBUTES

Attribute Name	Tag	Type	Note
Specific Character Set	(0008,0005)	-	Set to "ISO_IR 100" if extended characters are used in query. ISO_IR 100 is supported in responses.

15.4.4 Image Level

This section defines the keys at the Image Level of the Study Root Query/Retrieve Information Model that are supported by this implementation.

TABLE 15-8

IMAGE LEVEL ATTRIBUTES FOR THE STUDY ROOT
QUERY/RETRIEVE INFORMATION MODEL

Attribute Name	Tag	Type	Type of Matching
Instance Number	(0020,0013)	R	U
SOP Instance UID	(0008,0018)	U	UNIQUE
Contrast/Bolus Agent	(0018,0010)	O	U

TABLE 15-9
Q/R IMAGE LEVEL AND LOCATION FOR RETRIEVE ATTRIBUTES

Attribute Name	Tag	Type	Note
Query Retrieve Level	(0008,0052)	-	Value = IMAGE

TABLE 15-10
Q/R SPECIFIC CHARACTER SET ATTRIBUTES

Attribute Name	Tag	Type	Note
Specific Character Set	(0008,0005)	-	Set to "ISO_IR 100" if extended characters are used in query. ISO_IR 100 is supported in responses.

15.5 PRIVATE DATA DICTIONARY

No private data dictionary is defined.

16. DICOM SR TEMPLATES

16.1 VASCULAR ULTRASOUND PROCEDURE REPORT

This section describes the contents of the Vascular Ultrasound Procedure Report (TID 5100) SR.

16.1.1 Vascular Template Structure

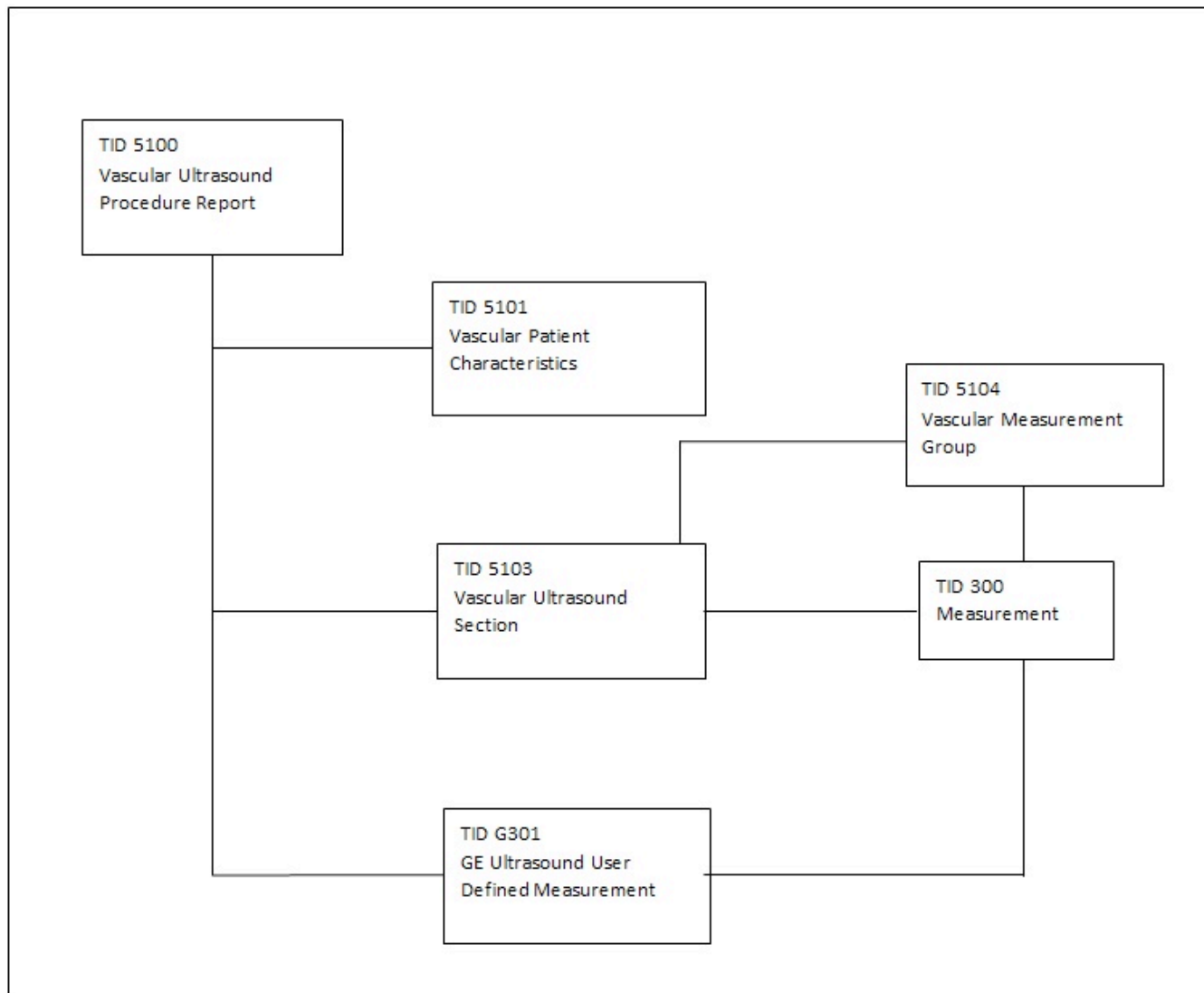

16.1.2 Usage and Extension of TID 5100 Vascular Ultrasound Report

LOGIQ E8 supports the following template TID 5100 for SOP Instances created by this product when exam types selected are Vascular and Abdomen.

TABLE 16-1 TID 5100

	NL	Relation with Parent	Value Type	Concept Name	VM	Req Type	Condition	Value Set Constraint
1			CONTAINER	EV (125100, DCM, "Vascular Ultrasound Procedure Report")	1	M		
2	>	CONTAINS	INCLUDE	DTID (5101) Vascular Patient Characteristics	1	U		
3	>	CONTAINS	INCLUDE	DTID (5103) Vascular Ultrasound Section	1-n	U		
4	>	CONTAINS	INCLUDE	DTID (G301) GE Ultrasound User Defined Measurement	1-n	UC	When User creates user defined measurements via Measurement Configuration	

16.1.3 TID 5101 Vascular Patient Characteristics

TABLE 16-2 TID 5101

	NL	Relation with Parent	Value Type	Concept Name	VM	Req Type	Condition	Value Set Constraint
1			CONTAINER	EV (121118, DCM, "Patient Characteristics")	1	M		
2	>	CONTAINS	NUM	EV (121033, DCM, "Subject Age")	1	U		Units = DCID (7456) Units of Measure for Age
3	>	CONTAINS	CODE	EV (121032, DCM, "Subject Sex")	1	U		DCID (7455) Sex
4	>	CONTAINS	NUM	EV (8867-4, LN, "Heart Rate")	1	U		
5	>	CONTAINS	NUM	EV (F-008EC, SRT, "Systolic Blood Pressure")	1	U		
6	>	CONTAINS	NUM	EV (F-008ED, SRT, "Diastolic Blood Pressure")	1	U		

16.1.4 TID 5103 Vascular Ultrasound Section

TABLE 16-3 TID 5103

	NL	Relation with Parent	Value Type	Concept Name	VM	Req Type	Condition	Value Set Constraint
1			CONTAINER	DT (121070, DCM, "Findings")	1	M		
2	>	HAS CONCEPT MOD	CODE	EV (G-C0E3, SRT, "Finding Site")	1	M		See Table 16-5 GEU Applications and Extensions- \$SectionScope
3	>	HAS CONCEPT MOD	CODE	EV (G-C171, SRT, "Laterality")	1	MC	IFF Laterality is defined	See Table 16-8 GE Ultrasound Sidedness
4	>	HAS CONCEPT MOD	CODE	EV (G-0373, SRT, "Image Mode")	1	U		See Table 16-7 GE Ultrasound Modes
5	>	CONTAINS	INCLUDE	DTID (5104) Vascular Measurement Group	1-n	M		See Table 16-4 TID 5104

DIR DOC1585895 REV 2

6	>	CONTAINS	INCLUDE	DTID (300) Measurement	1-n	U		\$Measurement = \$AnatomyRatio Anatomy ratio is from Table 16-5
---	---	----------	---------	------------------------	-----	---	--	--

16.1.5 TID 5104 Vascular Ultrasound Measurement Group (extended)

TABLE 16-4 TID 5104

	NL	Relation with Parent	Value Type	Concept Name	VM	Req Type	Condition	Value Set Constraint
1			CONTAINER	\$Anatomy GEU Parameters	1	M		See Table 16-5 GEU Applications and Extensions
2	>	HAS CONCEPT MOD	CODE	EV (G-A1F8, SRT, 'Topographical Modifier')	1	U		See Table 16-9 GE Ultrasound Vessel Location
3	>	HAS CONCEPT MOD	TEXT	EV (125101, DCM, 'Vessel Branch')	1	UC	When user name vessel more specific	Vessel branch defined by user.
4	>	HAS CONCEPT MOD	TEXT	EV (GEU-1005-7, 99GEMS, Anatomy Label)	1	UC	When user insert user defined study measurements	Text Value of Vessel Name or Folder
5	>	CONTAINS	INCLUDE	DTID (300) Measurement	1-n	U		\$Measurement = See 16.1.10 \$Derivation = See DCID (3627) Measurement Type Anatomy ratio is from Table 16-5

16.1.6 GEU Applications and Extensions

This section specifies for each type of vascular study the anatomy for which the application can create measurements, and the mapping from the user interface abbreviations to the SNOMED codes.

TABLE 16-5 GEU APPLICATIONS AND EXTENSIONS

Section Scope	Section Laterality	Anatomy	Anatomy Ratio	GEU Parameters Base Measurement Concept Name
DT (121070, DCM, 'Findings')	EV (G-C171, SRT, "Laterality")			

(T-40501, SRT, 'Blood Vessel of Head')	(G-A101, SRT, Left) for Left, (G-A100, SRT, Right) for Right. Or (G-A103, SRT, Unilateral)	DCID 12105 Intracranial Cerebral Vessels Or DCID 12106 Intracranial Cerebral Vessels (Unilateral)		<table border="1"> <thead> <tr> <th>Anatomy GEU parameter</th> <th>Code and Description</th> </tr> </thead> <tbody> <tr> <td>ICA</td> <td>(T-45300, SRT, 'Internal Carotid Artery')</td> </tr> <tr> <td>MCA</td> <td>(T-45600, SRT, 'Middle Cerebral Artery')</td> </tr> <tr> <td>ACA</td> <td>(T-45540, SRT, 'Anterior Cerebral Artery')</td> </tr> <tr> <td>PCA</td> <td>(T-45900, SRT, 'Posterior Cerebral Artery')</td> </tr> <tr> <td>PComA</td> <td>(T-45320, SRT, 'Posterior Communicating Artery')</td> </tr> <tr> <td>AComA</td> <td>(T-45530, SRT, 'Anterior Communicating Artery')</td> </tr> <tr> <td>BA</td> <td>(T-45800, SRT, 'Basilar Artery')</td> </tr> <tr> <td>VERT</td> <td>(T-45700, SRT, 'Vertebral Artery')</td> </tr> <tr> <td>Basilar</td> <td>(T-45800, SRT, 'Basilar Artery')</td> </tr> <tr> <td>Ves</td> <td>(GEU-1005-6, 99GEMS, 'User Vessel Anatomy'); (GEU-1005-7, 99GEMS, 'Anatomy Label') : Ves</td> </tr> <tr> <td>Others</td> <td>(GEU-1005-3, 99GEMS, General Anatomy)</td> </tr> </tbody> </table> <p style="text-align: center;">Table v.1 TCD Study Folder Code MAP</p>	Anatomy GEU parameter	Code and Description	ICA	(T-45300, SRT, 'Internal Carotid Artery')	MCA	(T-45600, SRT, 'Middle Cerebral Artery')	ACA	(T-45540, SRT, 'Anterior Cerebral Artery')	PCA	(T-45900, SRT, 'Posterior Cerebral Artery')	PComA	(T-45320, SRT, 'Posterior Communicating Artery')	AComA	(T-45530, SRT, 'Anterior Communicating Artery')	BA	(T-45800, SRT, 'Basilar Artery')	VERT	(T-45700, SRT, 'Vertebral Artery')	Basilar	(T-45800, SRT, 'Basilar Artery')	Ves	(GEU-1005-6, 99GEMS, 'User Vessel Anatomy'); (GEU-1005-7, 99GEMS, 'Anatomy Label') : Ves	Others	(GEU-1005-3, 99GEMS, General Anatomy)										
Anatomy GEU parameter	Code and Description																																					
ICA	(T-45300, SRT, 'Internal Carotid Artery')																																					
MCA	(T-45600, SRT, 'Middle Cerebral Artery')																																					
ACA	(T-45540, SRT, 'Anterior Cerebral Artery')																																					
PCA	(T-45900, SRT, 'Posterior Cerebral Artery')																																					
PComA	(T-45320, SRT, 'Posterior Communicating Artery')																																					
AComA	(T-45530, SRT, 'Anterior Communicating Artery')																																					
BA	(T-45800, SRT, 'Basilar Artery')																																					
VERT	(T-45700, SRT, 'Vertebral Artery')																																					
Basilar	(T-45800, SRT, 'Basilar Artery')																																					
Ves	(GEU-1005-6, 99GEMS, 'User Vessel Anatomy'); (GEU-1005-7, 99GEMS, 'Anatomy Label') : Ves																																					
Others	(GEU-1005-3, 99GEMS, General Anatomy)																																					
(T-45005, SRT, 'Artery of neck)	(G-A101, SRT, Left) for Left, or (G-A100, SRT, Right) for Right.	DCID (12104) Extracranial Arteries	DCID (12123) Carotid Ratios	<table border="1"> <thead> <tr> <th>Anatomy GEU parameter</th> <th>Code and Description</th> </tr> </thead> <tbody> <tr> <td>VERT</td> <td>(T-45700, SRT, 'Vertebral Artery')</td> </tr> <tr> <td>CCA</td> <td>(T-45100, SRT, 'Common Carotid Artery')</td> </tr> <tr> <td>ICA</td> <td>(T-45300, SRT, 'Internal Carotid Artery')</td> </tr> <tr> <td>BULB</td> <td>(T-45170, SRT, 'Carotid Bulb')</td> </tr> <tr> <td>ECA</td> <td>(T-45200, SRT, 'External Carotid Artery')</td> </tr> <tr> <td>SUBC</td> <td>(T-46100, SRT, 'Subclavian Artery')</td> </tr> <tr> <td>BIF</td> <td>(T-45160, SRT, 'Carotid Bifurcation')</td> </tr> <tr> <td>STA</td> <td>(T-45270, SRT, 'Superficial Temporal Artery')</td> </tr> <tr> <td>Frontal Branch</td> <td>(T-45270, SRT, 'Superficial Temporal Artery'); (125101, DCM, 'Vessel branch'): 'Frontal'</td> </tr> <tr> <td>ParietalBranch</td> <td>(T-45270, SRT, 'Superficial Temporal Artery'); (125101, DCM, 'Vessel branch'): 'Parietal'</td> </tr> <tr> <td>Pre-Stent</td> <td>(GEU-1004-71, 99GEMS, 'Pre-Stent')</td> </tr> <tr> <td>Stent</td> <td>(A-25500, SRT, 'Stent')</td> </tr> <tr> <td>Post-Stent</td> <td>(GEU-1004-72, 99GEMS, 'Post-Stent')</td> </tr> <tr> <td>2D/Stenosis</td> <td>(T-45300, SRT, Internal Carotid Artery)</td> </tr> <tr> <td>Ves</td> <td>(GEU-1005-6, 99GEMS, 'User Vessel Anatomy'); (GEU-1005-7, 99GEMS, 'Anatomy Label') : Ves</td> </tr> <tr> <td>Others</td> <td>(GEU-1005-3, 99GEMS, General Anatomy)</td> </tr> </tbody> </table> <p style="text-align: center;">Table v.2 Carotid Study FOLDER Code MAPS</p>	Anatomy GEU parameter	Code and Description	VERT	(T-45700, SRT, 'Vertebral Artery')	CCA	(T-45100, SRT, 'Common Carotid Artery')	ICA	(T-45300, SRT, 'Internal Carotid Artery')	BULB	(T-45170, SRT, 'Carotid Bulb')	ECA	(T-45200, SRT, 'External Carotid Artery')	SUBC	(T-46100, SRT, 'Subclavian Artery')	BIF	(T-45160, SRT, 'Carotid Bifurcation')	STA	(T-45270, SRT, 'Superficial Temporal Artery')	Frontal Branch	(T-45270, SRT, 'Superficial Temporal Artery'); (125101, DCM, 'Vessel branch'): 'Frontal'	ParietalBranch	(T-45270, SRT, 'Superficial Temporal Artery'); (125101, DCM, 'Vessel branch'): 'Parietal'	Pre-Stent	(GEU-1004-71, 99GEMS, 'Pre-Stent')	Stent	(A-25500, SRT, 'Stent')	Post-Stent	(GEU-1004-72, 99GEMS, 'Post-Stent')	2D/Stenosis	(T-45300, SRT, Internal Carotid Artery)	Ves	(GEU-1005-6, 99GEMS, 'User Vessel Anatomy'); (GEU-1005-7, 99GEMS, 'Anatomy Label') : Ves	Others	(GEU-1005-3, 99GEMS, General Anatomy)
Anatomy GEU parameter	Code and Description																																					
VERT	(T-45700, SRT, 'Vertebral Artery')																																					
CCA	(T-45100, SRT, 'Common Carotid Artery')																																					
ICA	(T-45300, SRT, 'Internal Carotid Artery')																																					
BULB	(T-45170, SRT, 'Carotid Bulb')																																					
ECA	(T-45200, SRT, 'External Carotid Artery')																																					
SUBC	(T-46100, SRT, 'Subclavian Artery')																																					
BIF	(T-45160, SRT, 'Carotid Bifurcation')																																					
STA	(T-45270, SRT, 'Superficial Temporal Artery')																																					
Frontal Branch	(T-45270, SRT, 'Superficial Temporal Artery'); (125101, DCM, 'Vessel branch'): 'Frontal'																																					
ParietalBranch	(T-45270, SRT, 'Superficial Temporal Artery'); (125101, DCM, 'Vessel branch'): 'Parietal'																																					
Pre-Stent	(GEU-1004-71, 99GEMS, 'Pre-Stent')																																					
Stent	(A-25500, SRT, 'Stent')																																					
Post-Stent	(GEU-1004-72, 99GEMS, 'Post-Stent')																																					
2D/Stenosis	(T-45300, SRT, Internal Carotid Artery)																																					
Ves	(GEU-1005-6, 99GEMS, 'User Vessel Anatomy'); (GEU-1005-7, 99GEMS, 'Anatomy Label') : Ves																																					
Others	(GEU-1005-3, 99GEMS, General Anatomy)																																					

DIR DOC1585895 REV 2

(T-47040, SRT, 'Artery of Lower Extremity')	(G-A101, SRT, Left) for Left, or (G-A100, SRT, Right) for Right.	DCID (12109) Lower Extremity Arteries		Anatomy GEU parameter	Code and Description
				ComIliac	(T-46710, SRT, 'Common Iliac Artery')
				ExtIliac	(T-46910, SRT, 'External Iliac Artery')
				ComFemoral	(T-47400, SRT, 'Common Femoral Artery')
				SupFemoral	(T-47403, SRT, 'Superficial Femoral Artery')
				Popliteal	(T-47500, SRT, 'Popliteal Artery')
				AntTibial	(T-47700, SRT, 'Anterior Tibial Artery')
				PostTibial	T-47600, SRT, 'Posterior Tibial Artery')
				Peroneal	(T-47630, SRT, 'Peroneal Artery')
				DorsPedis	(T-47741, SRT, 'Dorsalis Pedis Artery')
				DeepFemoral	(T-47440, SRT, 'Profunda Femoris Artery')
				Profunda	(T-47440, SRT, 'Profunda Femoris Artery')
				Pseudo	(M-32390, SRT, 'Pseudo Aneurysm')
				AVF	(M-39390, SRT, 'AV Fistula')
				Graft	(T-D000F, SRT, 'Vascular Graft')
				Stent	(A-25500, SRT, 'Stent')
				Pre-Stent	(GEU-1004-71, 99GEMS, 'Pre-Stent')
				Post-Stent	(GEU-1004-72, 99GEMS, 'Post-Stent')
				Ves	(GEU-1005-6, 99GEMS, 'User Vessel Anatomy'); (GEU-1005-7, 99GEMS, 'Anatomy Label') : Ves
				2D/Stenosis	(T-47403, SRT, 'Superficial Femoral Artery')
Others	(GEU-1005-3, 99GEMS, General Anatomy)				

Table V.3 LEA STUDY Folder CODE MAPS

(T-49403, SRT, 'Vein of Lower Extremity')	(G-A101, SRT, Left) for Left, or (G-A100, SRT, Right) for Right.	DCID (12110) Lower Extremity of Veins		<table border="1"> <thead> <tr> <th data-bbox="841 197 1013 254">Anatomy GEU parameter</th> <th data-bbox="1018 197 1430 254">Code and Description</th> </tr> </thead> <tbody> <tr> <td data-bbox="841 260 1013 296">Popliteal</td> <td data-bbox="1018 260 1430 296">(T-49640, SRT, 'Popliteal Vein')</td> </tr> <tr> <td data-bbox="841 302 1013 338">LSaphenous</td> <td data-bbox="1018 302 1430 338">(T-49550, SRT, 'Lesser Saphenous Vein')</td> </tr> <tr> <td data-bbox="841 344 1013 380">AntTibial</td> <td data-bbox="1018 344 1430 380">(T-49630, SRT, 'Anterior Tibial Vein')</td> </tr> <tr> <td data-bbox="841 386 1013 422">PostTibial</td> <td data-bbox="1018 386 1430 422">(T-49620, SRT, 'Posterior Tibial Vein')</td> </tr> <tr> <td data-bbox="841 428 1013 464">Peroneal</td> <td data-bbox="1018 428 1430 464">(T-49650, SRT, 'Peroneal Vein')</td> </tr> <tr> <td data-bbox="841 470 1013 506">Profunda</td> <td data-bbox="1018 470 1430 506">(T-49660, SRT, 'Profunda Femoris Vein')</td> </tr> <tr> <td data-bbox="841 512 1013 548">Gsaphenous</td> <td data-bbox="1018 512 1430 548">(T-49530, SRT, 'Great Saphenous Vein')</td> </tr> <tr> <td data-bbox="841 554 1013 590">GreatSaphThigh</td> <td data-bbox="1018 554 1430 590">(R-10259, SRT, 'Great Saphenous Vein of Thigh')</td> </tr> <tr> <td data-bbox="841 596 1013 632">GreatSaphCalf</td> <td data-bbox="1018 596 1430 632">(R-1025A, SRT, 'Great Saphenous Vein of Calf')</td> </tr> <tr> <td data-bbox="841 638 1013 695">GreatSaphKnee</td> <td data-bbox="1018 638 1430 695">(T-49530, SRT, 'Great Saphenous Vein') with finding side (T-D9200, SRT, 'Knee')</td> </tr> <tr> <td data-bbox="841 701 1013 758">GreatSaphAnkle</td> <td data-bbox="1018 701 1430 758">(T-49530, SRT, 'Great Saphenous Vein') with finding side (T-15750, SRT, 'Ankle')</td> </tr> <tr> <td data-bbox="841 764 1013 800">SaphPopJunc</td> <td data-bbox="1018 764 1430 800">(T-4941A, SRT, 'Saphenopopliteal junction')</td> </tr> <tr> <td data-bbox="841 806 1013 863">SmallSaphCalf</td> <td data-bbox="1018 806 1430 863">(T-49550, SRT, 'Lesser Saphenous Vein') w/i finding side (T-D9440, SRT, 'Calf of Leg')</td> </tr> <tr> <td data-bbox="841 869 1013 926">SmallSaphAnkle</td> <td data-bbox="1018 869 1430 926">(T-49550, SRT, 'Lesser Saphenous Vein') w/I finding side (T-15750, SRT, 'Ankle')</td> </tr> <tr> <td data-bbox="841 932 1013 989">SmallSaphCranial Ext</td> <td data-bbox="1018 932 1430 989">(GEU-1004-45, 99GEMS, 'Lesser Saphenous Vein Flows to Cranial Ext')</td> </tr> <tr> <td data-bbox="841 995 1013 1031">SaphFemJunc</td> <td data-bbox="1018 995 1430 1031">(T-D930A, SRT, 'Saphenofemoral Junction')</td> </tr> <tr> <td data-bbox="841 1037 1013 1073">Femoral</td> <td data-bbox="1018 1037 1430 1073">(G-035B, SRT, 'Femoral Vein')</td> </tr> <tr> <td data-bbox="841 1079 1013 1115">ComFemoral</td> <td data-bbox="1018 1079 1430 1115">(G-035B, SRT, 'Common Femoral Vein')</td> </tr> <tr> <td data-bbox="841 1121 1013 1157">ComIliac</td> <td data-bbox="1018 1121 1430 1157">(T-48920, SRT, 'Common Iliac Vein')</td> </tr> <tr> <td data-bbox="841 1163 1013 1199">ExtIliac</td> <td data-bbox="1018 1163 1430 1199">(T-48930, SRT, 'External Iliac Vein')</td> </tr> <tr> <td data-bbox="841 1205 1013 1241">IVC</td> <td data-bbox="1018 1205 1430 1241">(T-48710, SRT, 'Inferior Vena Cava')</td> </tr> <tr> <td data-bbox="841 1247 1013 1304">Ves</td> <td data-bbox="1018 1247 1430 1304">(GEU-1005-6, 99GEMS, 'User Vessel Anatomy'); (GEU-1005-7, 99GEMS, 'Anatomy Label') : Ves</td> </tr> <tr> <td data-bbox="841 1310 1013 1346">Others</td> <td data-bbox="1018 1310 1430 1346">(GEU-1005-3, 99GEMS, General Anatomy)</td> </tr> </tbody> </table>	Anatomy GEU parameter	Code and Description	Popliteal	(T-49640, SRT, 'Popliteal Vein')	LSaphenous	(T-49550, SRT, 'Lesser Saphenous Vein')	AntTibial	(T-49630, SRT, 'Anterior Tibial Vein')	PostTibial	(T-49620, SRT, 'Posterior Tibial Vein')	Peroneal	(T-49650, SRT, 'Peroneal Vein')	Profunda	(T-49660, SRT, 'Profunda Femoris Vein')	Gsaphenous	(T-49530, SRT, 'Great Saphenous Vein')	GreatSaphThigh	(R-10259, SRT, 'Great Saphenous Vein of Thigh')	GreatSaphCalf	(R-1025A, SRT, 'Great Saphenous Vein of Calf')	GreatSaphKnee	(T-49530, SRT, 'Great Saphenous Vein') with finding side (T-D9200, SRT, 'Knee')	GreatSaphAnkle	(T-49530, SRT, 'Great Saphenous Vein') with finding side (T-15750, SRT, 'Ankle')	SaphPopJunc	(T-4941A, SRT, 'Saphenopopliteal junction')	SmallSaphCalf	(T-49550, SRT, 'Lesser Saphenous Vein') w/i finding side (T-D9440, SRT, 'Calf of Leg')	SmallSaphAnkle	(T-49550, SRT, 'Lesser Saphenous Vein') w/I finding side (T-15750, SRT, 'Ankle')	SmallSaphCranial Ext	(GEU-1004-45, 99GEMS, 'Lesser Saphenous Vein Flows to Cranial Ext')	SaphFemJunc	(T-D930A, SRT, 'Saphenofemoral Junction')	Femoral	(G-035B, SRT, 'Femoral Vein')	ComFemoral	(G-035B, SRT, 'Common Femoral Vein')	ComIliac	(T-48920, SRT, 'Common Iliac Vein')	ExtIliac	(T-48930, SRT, 'External Iliac Vein')	IVC	(T-48710, SRT, 'Inferior Vena Cava')	Ves	(GEU-1005-6, 99GEMS, 'User Vessel Anatomy'); (GEU-1005-7, 99GEMS, 'Anatomy Label') : Ves	Others	(GEU-1005-3, 99GEMS, General Anatomy)	
Anatomy GEU parameter	Code and Description																																																				
Popliteal	(T-49640, SRT, 'Popliteal Vein')																																																				
LSaphenous	(T-49550, SRT, 'Lesser Saphenous Vein')																																																				
AntTibial	(T-49630, SRT, 'Anterior Tibial Vein')																																																				
PostTibial	(T-49620, SRT, 'Posterior Tibial Vein')																																																				
Peroneal	(T-49650, SRT, 'Peroneal Vein')																																																				
Profunda	(T-49660, SRT, 'Profunda Femoris Vein')																																																				
Gsaphenous	(T-49530, SRT, 'Great Saphenous Vein')																																																				
GreatSaphThigh	(R-10259, SRT, 'Great Saphenous Vein of Thigh')																																																				
GreatSaphCalf	(R-1025A, SRT, 'Great Saphenous Vein of Calf')																																																				
GreatSaphKnee	(T-49530, SRT, 'Great Saphenous Vein') with finding side (T-D9200, SRT, 'Knee')																																																				
GreatSaphAnkle	(T-49530, SRT, 'Great Saphenous Vein') with finding side (T-15750, SRT, 'Ankle')																																																				
SaphPopJunc	(T-4941A, SRT, 'Saphenopopliteal junction')																																																				
SmallSaphCalf	(T-49550, SRT, 'Lesser Saphenous Vein') w/i finding side (T-D9440, SRT, 'Calf of Leg')																																																				
SmallSaphAnkle	(T-49550, SRT, 'Lesser Saphenous Vein') w/I finding side (T-15750, SRT, 'Ankle')																																																				
SmallSaphCranial Ext	(GEU-1004-45, 99GEMS, 'Lesser Saphenous Vein Flows to Cranial Ext')																																																				
SaphFemJunc	(T-D930A, SRT, 'Saphenofemoral Junction')																																																				
Femoral	(G-035B, SRT, 'Femoral Vein')																																																				
ComFemoral	(G-035B, SRT, 'Common Femoral Vein')																																																				
ComIliac	(T-48920, SRT, 'Common Iliac Vein')																																																				
ExtIliac	(T-48930, SRT, 'External Iliac Vein')																																																				
IVC	(T-48710, SRT, 'Inferior Vena Cava')																																																				
Ves	(GEU-1005-6, 99GEMS, 'User Vessel Anatomy'); (GEU-1005-7, 99GEMS, 'Anatomy Label') : Ves																																																				
Others	(GEU-1005-3, 99GEMS, General Anatomy)																																																				

Table V.4 LEV STUDY FOLDER CODE MAPS

(T-47020, SRT, 'Artery of Upper Extremity')	(G-A101, SRT, Left) for Left, or (G-A100, SRT, Right) for Right.	DCID (12107) Upper Extremity Arteries		<p>Section Artery of Upper Extremity</p> <table border="1"> <thead> <tr> <th data-bbox="841 247 1040 310">Anatomy GEU parameter</th> <th data-bbox="1040 247 1442 310">Code and Description</th> </tr> </thead> <tbody> <tr> <td data-bbox="841 310 1040 348">SUBC</td> <td data-bbox="1040 310 1442 348">(T-46100, SRT, 'Subclavian artery')</td> </tr> <tr> <td data-bbox="841 348 1040 386">Axill</td> <td data-bbox="1040 348 1442 386">(T-47100, SRT, 'Axillary artery')</td> </tr> <tr> <td data-bbox="841 386 1040 424">BrachialA</td> <td data-bbox="1040 386 1442 424">(T-47160, SRT, 'Brachial artery')</td> </tr> <tr> <td data-bbox="841 424 1040 462">RadialA</td> <td data-bbox="1040 424 1442 462">(T-47300, SRT, 'Radial artery')</td> </tr> <tr> <td data-bbox="841 462 1040 499">UlnarA</td> <td data-bbox="1040 462 1442 499">(T-47200, SRT, 'Ulnar artery')</td> </tr> <tr> <td data-bbox="841 499 1040 562">Palmar</td> <td data-bbox="1040 499 1442 562">(T-47340, SRT, 'Deep Palmar Arch of Radial Artery')</td> </tr> <tr> <td data-bbox="841 562 1040 600">Innominate</td> <td data-bbox="1040 562 1442 600">(T-46010, SRT, 'Innominate Artery')</td> </tr> <tr> <td data-bbox="841 600 1040 638">Pseudo</td> <td data-bbox="1040 600 1442 638">(M-32390, SRT, 'Pseudo Aneurysm')</td> </tr> <tr> <td data-bbox="841 638 1040 676">AVF</td> <td data-bbox="1040 638 1442 676">(M-39390, SRT, 'AV Fistula')</td> </tr> <tr> <td data-bbox="841 676 1040 781">Ves</td> <td data-bbox="1040 676 1442 781">(GEU-1005-6, 99GEMS, 'User Vessel Anatomy'); (GEU-1005-7, 99GEMS, 'Anatomy Label') : Ves</td> </tr> <tr> <td data-bbox="841 781 1040 819">Stent</td> <td data-bbox="1040 781 1442 819">(A-25500, SRT, 'Stent')</td> </tr> <tr> <td data-bbox="841 819 1040 856">Pre-Stent</td> <td data-bbox="1040 819 1442 856">(GEU-1004-71, 99GEMS, 'Pre-Stent')</td> </tr> <tr> <td data-bbox="841 856 1040 894">Post-Stent</td> <td data-bbox="1040 856 1442 894">(GEU-1004-72, 99GEMS, 'Post-Stent')</td> </tr> <tr> <td data-bbox="841 894 1040 932">2D/Stenosis</td> <td data-bbox="1040 894 1442 932">(T-46100, SRT, 'Subclavian artery')</td> </tr> <tr> <td data-bbox="841 932 1040 970">Others</td> <td data-bbox="1040 932 1442 970">(GEU-1005-3, 99GEMS, General Anatomy)</td> </tr> </tbody> </table> <p>Table V.5 UEA Study Folder CODE MAPS</p>	Anatomy GEU parameter	Code and Description	SUBC	(T-46100, SRT, 'Subclavian artery')	Axill	(T-47100, SRT, 'Axillary artery')	BrachialA	(T-47160, SRT, 'Brachial artery')	RadialA	(T-47300, SRT, 'Radial artery')	UlnarA	(T-47200, SRT, 'Ulnar artery')	Palmar	(T-47340, SRT, 'Deep Palmar Arch of Radial Artery')	Innominate	(T-46010, SRT, 'Innominate Artery')	Pseudo	(M-32390, SRT, 'Pseudo Aneurysm')	AVF	(M-39390, SRT, 'AV Fistula')	Ves	(GEU-1005-6, 99GEMS, 'User Vessel Anatomy'); (GEU-1005-7, 99GEMS, 'Anatomy Label') : Ves	Stent	(A-25500, SRT, 'Stent')	Pre-Stent	(GEU-1004-71, 99GEMS, 'Pre-Stent')	Post-Stent	(GEU-1004-72, 99GEMS, 'Post-Stent')	2D/Stenosis	(T-46100, SRT, 'Subclavian artery')	Others	(GEU-1005-3, 99GEMS, General Anatomy)
Anatomy GEU parameter	Code and Description																																			
SUBC	(T-46100, SRT, 'Subclavian artery')																																			
Axill	(T-47100, SRT, 'Axillary artery')																																			
BrachialA	(T-47160, SRT, 'Brachial artery')																																			
RadialA	(T-47300, SRT, 'Radial artery')																																			
UlnarA	(T-47200, SRT, 'Ulnar artery')																																			
Palmar	(T-47340, SRT, 'Deep Palmar Arch of Radial Artery')																																			
Innominate	(T-46010, SRT, 'Innominate Artery')																																			
Pseudo	(M-32390, SRT, 'Pseudo Aneurysm')																																			
AVF	(M-39390, SRT, 'AV Fistula')																																			
Ves	(GEU-1005-6, 99GEMS, 'User Vessel Anatomy'); (GEU-1005-7, 99GEMS, 'Anatomy Label') : Ves																																			
Stent	(A-25500, SRT, 'Stent')																																			
Pre-Stent	(GEU-1004-71, 99GEMS, 'Pre-Stent')																																			
Post-Stent	(GEU-1004-72, 99GEMS, 'Post-Stent')																																			
2D/Stenosis	(T-46100, SRT, 'Subclavian artery')																																			
Others	(GEU-1005-3, 99GEMS, General Anatomy)																																			

(T-49103, SRT, 'Vein of Upper Extremity')	(G-A101, SRT, Left) for Left, or (G-A100, SRT, Right) for Right.	DCID (12108) Upper Extremity Veins		<table border="1"> <thead> <tr> <th data-bbox="841 197 1040 254">Anatomy GEU parameter</th> <th data-bbox="1049 197 1438 254">Code and Description</th> </tr> </thead> <tbody> <tr> <td>JugularV</td> <td>(T-48170, SRT, 'Internal Jugular vein')</td> </tr> <tr> <td>InnoV</td> <td>(T-48620, SRT, 'Innominate vein')</td> </tr> <tr> <td>SUBCV</td> <td>(T-48330, SRT, 'Subclavian vein')</td> </tr> <tr> <td>AxillV</td> <td>(T-49110, SRT, 'Axillary vein')</td> </tr> <tr> <td>CephV</td> <td>(T-49240, SRT, 'Cephalic vein')</td> </tr> <tr> <td>BasilV</td> <td>(T-48052, SRT, 'Basilic vein')</td> </tr> <tr> <td>BracV</td> <td>(T-49350, SRT, 'Brachial vein')</td> </tr> <tr> <td>McubV</td> <td>(T-49250, SRT, 'Median Cubital vein')</td> </tr> <tr> <td>RadialV</td> <td>(T-49340, SRT, 'Radial vein')</td> </tr> <tr> <td>UlnarV</td> <td>(T-49330, SRT, 'Ulnar vein')</td> </tr> <tr> <td>CephArm</td> <td>(T-49240, SRT, 'Cephalic vein'); finding side (T-D8200, SRT, 'Arm')</td> </tr> <tr> <td>CephAntecub</td> <td>(T-49240, SRT, 'Cephalic vein'); finding side (T-49215, SRT, 'Antecubital Vein')</td> </tr> <tr> <td>CephForearm</td> <td>(T-49240, SRT, 'Cephalic vein'); finding side (T-12402, SRT, 'Forearm')</td> </tr> <tr> <td>CephWrist</td> <td>(T-49240, SRT, 'Cephalic vein'); finding side (T-D8600, SRT, 'Wrist')</td> </tr> <tr> <td>BasilicArm</td> <td>(T-48052, SRT, 'Basilic vein') finding side (T-D8200, SRT, 'Arm')</td> </tr> <tr> <td>BasilicAntecub</td> <td>(T-48052, SRT, 'Basilic vein'); finding side (T-49215, SRT, 'Antecubital Vein')</td> </tr> <tr> <td>BasilicForearm</td> <td>(T-48052, SRT, 'Basilic vein'); finding side (T-12402, SRT, 'Forearm')</td> </tr> <tr> <td>BasilicWrist</td> <td>(T-48052, SRT, 'Basilic vein'); finding side (T-D8600, SRT, 'Wrist')</td> </tr> <tr> <td>Pseudo</td> <td>(M-32390, SRT, 'Pseudo Aneurysm')</td> </tr> <tr> <td>AVF</td> <td>(M-39390, SRT, 'AV Fistula')</td> </tr> <tr> <td>Ves</td> <td>(GEU-1005-6, 99GEMS, 'User Vessel Anatomy'); (GEU-1005-7, 99GEMS, 'Anatomy Label') : Ves</td> </tr> <tr> <td>Graft</td> <td>(T-D000F, SRT, 'Vascular Graft')</td> </tr> <tr> <td>Others</td> <td>(GEU-1005-3, 99GEMS, General Anatomy)</td> </tr> </tbody> </table>	Anatomy GEU parameter	Code and Description	JugularV	(T-48170, SRT, 'Internal Jugular vein')	InnoV	(T-48620, SRT, 'Innominate vein')	SUBCV	(T-48330, SRT, 'Subclavian vein')	AxillV	(T-49110, SRT, 'Axillary vein')	CephV	(T-49240, SRT, 'Cephalic vein')	BasilV	(T-48052, SRT, 'Basilic vein')	BracV	(T-49350, SRT, 'Brachial vein')	McubV	(T-49250, SRT, 'Median Cubital vein')	RadialV	(T-49340, SRT, 'Radial vein')	UlnarV	(T-49330, SRT, 'Ulnar vein')	CephArm	(T-49240, SRT, 'Cephalic vein'); finding side (T-D8200, SRT, 'Arm')	CephAntecub	(T-49240, SRT, 'Cephalic vein'); finding side (T-49215, SRT, 'Antecubital Vein')	CephForearm	(T-49240, SRT, 'Cephalic vein'); finding side (T-12402, SRT, 'Forearm')	CephWrist	(T-49240, SRT, 'Cephalic vein'); finding side (T-D8600, SRT, 'Wrist')	BasilicArm	(T-48052, SRT, 'Basilic vein') finding side (T-D8200, SRT, 'Arm')	BasilicAntecub	(T-48052, SRT, 'Basilic vein'); finding side (T-49215, SRT, 'Antecubital Vein')	BasilicForearm	(T-48052, SRT, 'Basilic vein'); finding side (T-12402, SRT, 'Forearm')	BasilicWrist	(T-48052, SRT, 'Basilic vein'); finding side (T-D8600, SRT, 'Wrist')	Pseudo	(M-32390, SRT, 'Pseudo Aneurysm')	AVF	(M-39390, SRT, 'AV Fistula')	Ves	(GEU-1005-6, 99GEMS, 'User Vessel Anatomy'); (GEU-1005-7, 99GEMS, 'Anatomy Label') : Ves	Graft	(T-D000F, SRT, 'Vascular Graft')	Others	(GEU-1005-3, 99GEMS, General Anatomy)
Anatomy GEU parameter	Code and Description																																																			
JugularV	(T-48170, SRT, 'Internal Jugular vein')																																																			
InnoV	(T-48620, SRT, 'Innominate vein')																																																			
SUBCV	(T-48330, SRT, 'Subclavian vein')																																																			
AxillV	(T-49110, SRT, 'Axillary vein')																																																			
CephV	(T-49240, SRT, 'Cephalic vein')																																																			
BasilV	(T-48052, SRT, 'Basilic vein')																																																			
BracV	(T-49350, SRT, 'Brachial vein')																																																			
McubV	(T-49250, SRT, 'Median Cubital vein')																																																			
RadialV	(T-49340, SRT, 'Radial vein')																																																			
UlnarV	(T-49330, SRT, 'Ulnar vein')																																																			
CephArm	(T-49240, SRT, 'Cephalic vein'); finding side (T-D8200, SRT, 'Arm')																																																			
CephAntecub	(T-49240, SRT, 'Cephalic vein'); finding side (T-49215, SRT, 'Antecubital Vein')																																																			
CephForearm	(T-49240, SRT, 'Cephalic vein'); finding side (T-12402, SRT, 'Forearm')																																																			
CephWrist	(T-49240, SRT, 'Cephalic vein'); finding side (T-D8600, SRT, 'Wrist')																																																			
BasilicArm	(T-48052, SRT, 'Basilic vein') finding side (T-D8200, SRT, 'Arm')																																																			
BasilicAntecub	(T-48052, SRT, 'Basilic vein'); finding side (T-49215, SRT, 'Antecubital Vein')																																																			
BasilicForearm	(T-48052, SRT, 'Basilic vein'); finding side (T-12402, SRT, 'Forearm')																																																			
BasilicWrist	(T-48052, SRT, 'Basilic vein'); finding side (T-D8600, SRT, 'Wrist')																																																			
Pseudo	(M-32390, SRT, 'Pseudo Aneurysm')																																																			
AVF	(M-39390, SRT, 'AV Fistula')																																																			
Ves	(GEU-1005-6, 99GEMS, 'User Vessel Anatomy'); (GEU-1005-7, 99GEMS, 'Anatomy Label') : Ves																																																			
Graft	(T-D000F, SRT, 'Vascular Graft')																																																			
Others	(GEU-1005-3, 99GEMS, General Anatomy)																																																			
<p>TABLE V.6 UEV STUDY FOLDER CODE MAPS</p>																																																				

(T-71019, SRT, 'Vascular Structure of Kidney')	(G-A101, SRT, Left) for Left, or (G-A100, SRT, Right) for Right.	DCID(12115) Renal Vessels	DCID(12124) Renal Ratios	Anatomy GEU parameter	Code and Description
				MRenalA	(T-46600, SRT, 'Renal Artery')
				RenalV	(T-48740, SRT, 'Renal Vein')
				SegmentalA	(T-46659, SRT, 'Segmental Artery')
				InterlobarA	(T-4667D, SRT, 'Interlobar Artery of Kidney')
				ArcuateA	(T-4668A, SRT, 'Arcuate Artery of the Kidney')
				Aorta	(T-42000, SRT, 'Aorta')
				Renal Volume	(T-71000, SRT, 'Kidney')
				Spleen	(T-C3000, SRT, 'Spleen')
				AAA	(R-002CD, SRT, 'Aneurysm of Aortic Root')
				Bladder	(T-74000, SRT, 'Bladder')
				PostBladder	(GEU-1004-62, 99GEMS, 'Post Bladder')
				Iliac	(T-46710, SRT, 'Common Iliac Artery')
				RenalLength	(T-71000, SRT, 'Kidney')
				NewBladder	(T-74000, SRT, 'Bladder')
				NewPostBladder	(GEU-1004-62, 99GEMS, 'Post Bladder')
				RAOrigin	(GEU-1005-4, 99GEMS, 'Renal Artery Origin')
				Ves	(GEU-1005-6, 99GEMS, 'User Vessel Anatomy'); (GEU-1005-7, 99GEMS, 'Anatomy Label') : Ves
				Others	(GEU-1005-3, 99GEMS, General Anatomy)

TABLE V.7-1. RENAL STUDY CODE MAPS

<p>(T-46002, SRT, 'Artery of Abdomen'),</p>	<p>(G-A101, SRT, Left) for Left, (G-A100, SRT, Right) for Right. Or (G-A103, SRT, Unilateral)</p>	<p>DCID 12111 or (12112) Abdominal Arteries (unilateral)</p>		<table border="1"> <thead> <tr> <th>Anatomy GEU parameter</th> <th>Code and Description</th> </tr> </thead> <tbody> <tr> <td>Aorta</td> <td>(T-42000, SRT, 'Aorta')</td> </tr> <tr> <td>Renal Length</td> <td>(T-71000, SRT, 'Kidney')</td> </tr> <tr> <td>Spleen</td> <td>(T-C3000, SRT, 'Spleen')</td> </tr> <tr> <td>Celiac</td> <td>(T-46400, SRT, 'Celiac Axis')</td> </tr> <tr> <td>Splenic A</td> <td>(T-46460, SRT, 'Splenic Artery')</td> </tr> <tr> <td>SMA</td> <td>(T-46510, SRT, 'Superior Mesenteric Artery')</td> </tr> <tr> <td>IMA</td> <td>(T-46520, SRT, 'Inferior Mesenteric Artery')</td> </tr> <tr> <td>CIA</td> <td>(T-46710, SRT, 'Common Iliac Artery')</td> </tr> <tr> <td>Stent</td> <td>(A-25500, SRT, 'Stent')</td> </tr> <tr> <td>Pre-Stent</td> <td>(GEU-1004-71, 99GEMS, 'Pre-Stent')</td> </tr> <tr> <td>Post-Stent</td> <td>(GEU-1004-72, 99GEMS, 'Post-Stent')</td> </tr> <tr> <td>HepaticA</td> <td>(T-46420, SRT, 'Hepatic Artery')</td> </tr> <tr> <td>IIA</td> <td>(T-46740, SRT, 'Internal Iliac Artery')</td> </tr> </tbody> </table>	Anatomy GEU parameter	Code and Description	Aorta	(T-42000, SRT, 'Aorta')	Renal Length	(T-71000, SRT, 'Kidney')	Spleen	(T-C3000, SRT, 'Spleen')	Celiac	(T-46400, SRT, 'Celiac Axis')	Splenic A	(T-46460, SRT, 'Splenic Artery')	SMA	(T-46510, SRT, 'Superior Mesenteric Artery')	IMA	(T-46520, SRT, 'Inferior Mesenteric Artery')	CIA	(T-46710, SRT, 'Common Iliac Artery')	Stent	(A-25500, SRT, 'Stent')	Pre-Stent	(GEU-1004-71, 99GEMS, 'Pre-Stent')	Post-Stent	(GEU-1004-72, 99GEMS, 'Post-Stent')	HepaticA	(T-46420, SRT, 'Hepatic Artery')	IIA	(T-46740, SRT, 'Internal Iliac Artery')		
Anatomy GEU parameter	Code and Description																																	
Aorta	(T-42000, SRT, 'Aorta')																																	
Renal Length	(T-71000, SRT, 'Kidney')																																	
Spleen	(T-C3000, SRT, 'Spleen')																																	
Celiac	(T-46400, SRT, 'Celiac Axis')																																	
Splenic A	(T-46460, SRT, 'Splenic Artery')																																	
SMA	(T-46510, SRT, 'Superior Mesenteric Artery')																																	
IMA	(T-46520, SRT, 'Inferior Mesenteric Artery')																																	
CIA	(T-46710, SRT, 'Common Iliac Artery')																																	
Stent	(A-25500, SRT, 'Stent')																																	
Pre-Stent	(GEU-1004-71, 99GEMS, 'Pre-Stent')																																	
Post-Stent	(GEU-1004-72, 99GEMS, 'Post-Stent')																																	
HepaticA	(T-46420, SRT, 'Hepatic Artery')																																	
IIA	(T-46740, SRT, 'Internal Iliac Artery')																																	
<p>Table V.8-1 Abdomen Study CODE MaPs (Page 1)</p>																																		
<p>(T-487A0, SRT, 'Vein of Abdomen)</p>	<p>(G-A101, SRT, Left) for Left, (G-A100, SRT, Right) for Right. Or (G-A103, SRT, Unilateral)</p>	<p>DCID 12113 or (12114) Abdominal Veins lateral (unilateral)</p>		<table border="1"> <thead> <tr> <th>Anatomy GEU parameter</th> <th>Code and Description</th> </tr> </thead> <tbody> <tr> <td>IIV</td> <td>(T-48940, SRT, 'Internal Iliac Vein')</td> </tr> <tr> <td>PortalVein</td> <td>(T-48810, SRT, 'Portal Vein')</td> </tr> <tr> <td>SMV</td> <td>(T-48840, SRT, 'Superior Mesenteric Vein')</td> </tr> <tr> <td>PortalV</td> <td>(T-48810, SRT, 'Portal Vein')</td> </tr> <tr> <td>SplenicV</td> <td>(T-48890, SRT, 'Splenic Vein')</td> </tr> <tr> <td>IMV</td> <td>(T-48910, SRT, 'Inferior Mesenteric Vein')</td> </tr> <tr> <td>HepaticV</td> <td>(T-48720, SRT, 'Hepatic Vein')</td> </tr> <tr> <td>PortalV</td> <td>(T-4882A, SRT, 'Right Main Branch of Portal Vein')</td> </tr> <tr> <td>PortalV</td> <td>(T-4881F, SRT, 'Left Main Branch of Portal Vein')</td> </tr> <tr> <td>HepaticA</td> <td>(T-46420, SRT, 'Hepatic Artery')</td> </tr> <tr> <td>CHA</td> <td>(T-46421, SRT, 'Common Hepatic Artery')</td> </tr> <tr> <td>Stent</td> <td>(A-25500, SRT, 'Stent')</td> </tr> <tr> <td>Pre-Stent</td> <td>(GEU-1004-71, 99GEMS, 'Pre-Stent')</td> </tr> <tr> <td>Post-Stent</td> <td>(GEU-1004-72, 99GEMS, 'Post-Stent')</td> </tr> </tbody> </table>	Anatomy GEU parameter	Code and Description	IIV	(T-48940, SRT, 'Internal Iliac Vein')	PortalVein	(T-48810, SRT, 'Portal Vein')	SMV	(T-48840, SRT, 'Superior Mesenteric Vein')	PortalV	(T-48810, SRT, 'Portal Vein')	SplenicV	(T-48890, SRT, 'Splenic Vein')	IMV	(T-48910, SRT, 'Inferior Mesenteric Vein')	HepaticV	(T-48720, SRT, 'Hepatic Vein')	PortalV	(T-4882A, SRT, 'Right Main Branch of Portal Vein')	PortalV	(T-4881F, SRT, 'Left Main Branch of Portal Vein')	HepaticA	(T-46420, SRT, 'Hepatic Artery')	CHA	(T-46421, SRT, 'Common Hepatic Artery')	Stent	(A-25500, SRT, 'Stent')	Pre-Stent	(GEU-1004-71, 99GEMS, 'Pre-Stent')	Post-Stent	(GEU-1004-72, 99GEMS, 'Post-Stent')
Anatomy GEU parameter	Code and Description																																	
IIV	(T-48940, SRT, 'Internal Iliac Vein')																																	
PortalVein	(T-48810, SRT, 'Portal Vein')																																	
SMV	(T-48840, SRT, 'Superior Mesenteric Vein')																																	
PortalV	(T-48810, SRT, 'Portal Vein')																																	
SplenicV	(T-48890, SRT, 'Splenic Vein')																																	
IMV	(T-48910, SRT, 'Inferior Mesenteric Vein')																																	
HepaticV	(T-48720, SRT, 'Hepatic Vein')																																	
PortalV	(T-4882A, SRT, 'Right Main Branch of Portal Vein')																																	
PortalV	(T-4881F, SRT, 'Left Main Branch of Portal Vein')																																	
HepaticA	(T-46420, SRT, 'Hepatic Artery')																																	
CHA	(T-46421, SRT, 'Common Hepatic Artery')																																	
Stent	(A-25500, SRT, 'Stent')																																	
Pre-Stent	(GEU-1004-71, 99GEMS, 'Pre-Stent')																																	
Post-Stent	(GEU-1004-72, 99GEMS, 'Post-Stent')																																	
<p>V – 9.2 Abdomen Vein Study Folder Code Maps</p>																																		

DIR DOC1585895 REV 2

(T-D000F, SRT, 'Vascular Graft')	(G-A101, SRT, Left) for Left, (G-A100, SRT, Right) for Right. Or (G-A103, SRT, Unilateral)	DCID 12113 or (12114) Abdominal Veins lateral (unilateral)		Anatomy GEU parameter	Code and Description
				Limb	(GEU-1004-46, 99GEMS, 'Limb')
				Inflow	(GEU-1004-63, 99GEMS, 'Inflow')
				Anast	(M-18200, SRT, 'Anastomosis')
				Outflow	(GEU-1004-44, 99GEMS, 'Outflow')
				Thigh	(T-D9100, SRT, 'Thigh')
				Knee	(T-D9200, SRT, 'Knee')
				Calf	(T-D9440, SRT, 'Calf of Leg')
				Ankle	(T-15750, SRT, 'Ankle')
				RunOff	(GEU-1004-43, 99GEMS, 'RunOff')
				VGraft	(T-D000F, SRT, 'Vascular Graft')
				Arm	(T-D8200, SRT, 'Arm')
				Ante Cub	(T-49215, SRT, 'Antecubital Vein')
				Forearm	(T-12402, SRT, 'Forearm')
				Wrist	(T-15460, SRT, 'Wrist joint')
				UserVessel	(GEU-1005-6, 99GEMS, 'User Vessel Anatomy')
Pre-Stent	(GEU-1004-71, 99GEMS, 'Pre-Stent')				
Stent	(A-25500, SRT, 'Stent')				
Post-Stent	(GEU-1004-72, 99GEMS, 'Post-Stent')				

16.1.7 TID 300 Measurement (extended for Vascular)

TABLE 16-6 GEU APPLICATIONS AND EXTENSIONS

	NL	Relation with Parent	Value Type	Concept Name	VM	Req Type	Condition	Value Set Constraint
1			NUM	\$Measurement	1	M		Units = \$Units
2	>	HAS CONCEPT MOD	TEXT	EV(GEU-1005-5, 99GEMS, Measurement Label)	1	UC	When Measurement is created by user (User Defined)	Measurement Label created by User (\$Label)
3	>	HAS CONCEPT MOD	CODE	EV(GEU-1005-5, 99GEMS, Measurement Label)	1	UC	Only for AP or Trans	- AP (122675, Anterior-Posterior, DCM,) - Trans (G-A117, Transverse, SRT)
4	>	HAS CONCEPT MOD	CODE	EV(G-A1F8, SRT, 'Topographical modifier')	1	U		See Table 16-9 GE Ultrasound Vessel Location
5	>	HAS CONCEPT MOD	CODE	EV(121401, DCM, 'Derivation')	1	U		\$Derivation
6	>	HAS PROPERTIES	CODE	EV(121404, DCM, 'Selection Status')	1	U		\$Selection Status

DIR DOC1585895 REV 2

16.1.8 GE Ultrasound Modes

TABLE 16-7 GE ULTRASOUND MODES

GE Ultrasound Modes	Code Value
2D	(G-03A2, SRT, "2D mode")
CF	(R-409E2, SRT, "Doppler Color Flow")
PW	(R-409E4, SRT, "Doppler Pulsed")
MM	(G-0394, SRT, "M mode")
CW	(R-409E3, SRT, "Doppler Continuous Wave")

16.1.9 GE Ultrasound Sidedness and Vessel Location

TABLE 16-8 GE ULTRASOUND SIDEDNESS

Side	Code Value
Rt	(G-A100, SRT, "Right")
Lt	(G-A101, SRT, "Left")

Note (*) when there is no Sidedness or Locations, the SR nodes are not populated

TABLE 16-9 GE ULTRASOUND VESSEL LOCATION

Vessel Location	Code Value
Prox	(G-A118, SRT, "Proximal")
Mid	(G-A188, SRT, "Mid-longitudinal")
Dist	(G-A119, SRT, "Distal")

16.1.10 SR Mapping Table for Vascular Base Measurement Concept

16.1.10.1 PWD-Mode MEASUREMENTS

TABLE 16-10 PWD-MODE MEASUREMENTS

GEU Measurement Parameter	Standard Measurement Concept Name
PS, Ps_velocitySD, Ps_velocityDS	(11726-7, LN, 'Peak Systolic Velocity')
ED, Ved	(11653-3, LN, 'End Diastolic Velocity')
MD, Md_velocitySD, Md_velocityDS	(11665-7, LN, 'Minimum Diastolic Velocity')
Tamax, TamaxM	(11692-1, LN, 'Time averaged peak velocity')
PI	(12008-9, LN, 'Pulsatility Index')
RI, PI/RI	(12023-8, LN, 'Resistivity Index')
SD Ratio, Ratio S/D	(12144-2, LN, 'Systolic to Diastolic Velocity Ratio')
DS Ratio, Ratio D/S	(122218, DCM, 'Diastolic to Systolic Velocity Ratio')
Accel	(20167-3, LN, 'Acceleration Index')
AT	(20168-1, LN, 'Acceleration Time')
TAMEAN	(20352-1, LN, 'Time averaged mean velocity')
VOLFLOW	(33878-0, LN, 'Volume flow')
ICACCA Ratio (PS)	(33868-1, LN, 'ICA/CCA velocity')
HR, HR Cycle	(8867-4, LN, 'Heart Rate')
RAR	(33869-9, LN, 'Renal Artery/Aorta velocity Ratio')

AC	(GEU-1004-9, 99GEMS, 'Angular Correction')
IVRatio	(GEU-1004-11, 99GEMS, 'Intra Vessel Ratio')
PS/Hz	(GEU-1004-13, 99GEMS, 'Peak Systolic Frequency')
ED/Hz	(GEU-1004-14, 99GEMS, 'End Diastolic Frequency')
PV/Hz	(GEU-1004-15, 99GEMS, 'Peak Velocity Frequency')
MD/Hz	(GEU-1004-16, 99GEMS, 'Minimum Diastolic Frequency')
Vmax	(GEU-1004-24, 99GEMS, 'Maximum Velocity')
Vmin	(GEU-1004-25, 99GEMS, 'Minimum Velocity')
MaxPG	(GEU-1004-26, 99GEMS, 'Maximum Pressure Gradient')
MeanPG	(GEU-1004-27, 99GEMS, 'Average Pressure Gradient')
GreatSaphAccess	(GEU-1004-73, 99GEMS, 'Great Saphenous Vein of Accessory')

16.1.10.2 Vascular B- MODE Measurements

TABLE 16-11 VASCULAR B-MODE MEASUREMENTS

GEU Measurement Parameter	Standard Measurement Concept Name
DiamStenD1, DiamStenD2	(G-0364, SRT, 'Vessel Lumen Diameter')
AreaStenA1, AreaStenA2	(G-0366, SRT, 'Vessel Lumen Cross-Sectional Area')
StenosisD, Stenosis	(R-101BB, SRT, 'Lumen Diameter Stenosis')
StenosisA	(R-101BA, SRT, 'Lumen Area Stenosis')
AP	(M-02550, SRT, 'Diameter') with Measurement Labels (122675, DCM, 'Anterior-Posterior')
Trans	(M-02550, SRT, 'Diameter') with Measurement Labels (G-A117, SRT, 'Transverse')
Angle	(GEU-1004-18, 99GEMS, 'Angle')
Ellipse	(125226, DCM, 'Single Plane Ellipse')
Area, AreaRatioA1, AreaRatioA2	(121056, DCM, 'Area Outline')
SplenicJPNL	(GEU-1004-56, 99GEMS, 'Splenic D1')
SplenicJPNH	(GEU-1004-57, 99GEMS, 'Splenic D2')
SplenicIndexJPN	(GEU-1004-58, 99GEMS, 'Splenic Index-JP')
IMT Ant Avg	(GEU-1005-20, 99GEMS, 'IMT Anterior Average')
IMT Ant Max	(GEU-1005-21, 99GEMS, 'IMT Anterior Max')
IMT Ant Min	(GEU-1005-22, 99GEMS, 'IMT Anterior Min')
IMT Ant SD	(GEU-1005-23, 99GEMS, 'IMT Anterior SD')
IMT Ant nMeas	(GEU-1005-24, 99GEMS, 'IMT Anterior nMeas')
IMT Ant Dist	(GEU-1005-25, 99GEMS, 'IMT Anterior Dist')
IMT Post Avg	(GEU-1005-26, 99GEMS, 'IMT Posterior Average')
IMT Post Max	(GEU-1005-27, 99GEMS, 'IMT Posterior Max')
IMT Post Min	(GEU-1005-28, 99GEMS, 'IMT Posterior Min')
IMT Post SD	(GEU-1005-29, 99GEMS, 'IMT Posterior SD')
IMT Post nMeas	(GEU-1005-30, 99GEMS, 'IMT Posterior nMeas')
IMT Post Dist	(GEU-1005-31, 99GEMS, 'IMT Posterior Dist')
DiamRatio	(GEU-1004-20, 99GEMS, 'Diameter Ratio')
VFDiam	(GEU-1004-49, 99GEMS, 'Volume Flow Diameter')
VolD1	(GEU-1004-52, 99GEMS, 'Volume Diameter 1')
VolD2	(GEU-1004-53, 99GEMS, 'Volume Diameter 2')
VolD3	(GEU-1004-54, 99GEMS, 'Volume Diameter 3')
ABDiamRatio	(GEU-1004-55, 99GEMS, 'A/B Diameter Ratio')

ABAreaRatio	(GEU-1004-66, 99GEMS, 'A/B Area Ratio')
-------------	---

16.1.10.3 Abdomen B- MODE Measurements

TABLE 16-12 ABDOMEN B-MODE MEASUREMENTS

GEU Measurement Parameter	Standard Measurement Concept Name
SpleenDistL, SpleenDistH, SpleenDistW, SpeenVolume	(Length, SRT,G-A22A), (Height, DCM, 121207), (Width, SRT, G-A220), (Volume, SRT, G-D705) inside (T-C3000, SRT, Spleen) container
RenalDistL, RenalDistH, RenalDistW, RenalVolume	(Length, SRT,G-A22A), (Height, DCM, 121207), (Width, SRT, G-A220), (Volume, SRT, G-D705) inside (T-71000, SRT, Kidney) container
BladderL, BladderH, BladderW, BladderVolume	(Length, SRT,G-A22A), (Height, DCM, 121207), (Width, SRT, G-A220), (Volume, SRT, G-D705) Inside (T-74000, SRT, Bladder) container
LiverL, LiverW	(Length, SRT,G-A22A), (Width, SRT, G-A220) Inside (T-62002, SRT, Liver) container
CBDporta, CBDpanc	(GEU-1004-67, 99GEMS, CBD Porta), (GEU-1004-68, 99GEMS, CBD Panc) (Length, SRT,G-A22A) inside (T-60610, SRT, Bile Duct)
CBD	(Length, SRT,G-A22A) inside (T-60610, SRT, Bile Duct)
PancHead, PancBody, PancDuct	(GEU-1004-59, 99GEMS, Pancreas Head), (GEU-1004-60, 99GEMS, Pancreas Body), (GEU-1004-61, 99GEMS, Pancreas Duct)
AAAL	(Length, SRT,G-A22A) inside (R-002CD, SRT, Aneurysm of Aortic Root)
GBW	(GEU-1004-38,99GEMS, Gall Bladder Wall)
AoProxAP, AoProxTrans	AP = (Diameter,SRT, M-02550), with Measurement Label (Anterior-Posterior, DCM, 122675), Trans = (Diameter,SRT, M-02550), with Measurement Label (Transverse , SRT, G-A117) inside (T-42000, SRT, Aorta) with (Proximal, SRT,G-A118) as Topographical Modifier
AoMidAP, AoMidTrans	AP = (Diameter,SRT, M-02550), with Measurement Label (Anterior-Posterior, DCM, 122675), Trans = (Diameter,SRT, M-02550), with Measurement Label (Transverse , SRT, G-A117) inside (T-42000, SRT, Aorta) with (Mid-longitudinal, SRT,G-A188) as Topographical Modifier
AoDistAP, AoDistTrans	AP = (Diameter,SRT, M-02550), with Measurement Label (Anterior-Posterior, DCM, 122675), Trans = (Diameter,SRT, M-02550), with Measurement Label (Transverse , SRT, G-A117) inside (T-42000, SRT, Aorta) with (Distal, SRT,G-A119) as Topographical Modifier
IliacAP, IliacTrans	AP = (Diameter,SRT, M-02550), with Measurement Label (Anterior-Posterior, DCM, 122675), Trans = (Diameter,SRT, M-02550), with Measurement Label (Transverse, SRT, G-A117)

16.1.11 TID G301 GE Ultrasound User Defined Measurement - Type: Extensible

The General Ultrasound User Defined Measurement Template provides a CONTAINER with a structure for reporting user-defined measurements and calculations.

The difference between this from TID 5103, TID 300 or 1414 for general measurement is the template uses labels that specified by users at configuration time rather assigning specific codes to the individual measurements.

Note: In practice, to assign specific codes to user defined measurements are impractical and cumbersome since the system/organization has to maintain database/map of codes and labels with public/private code designator schemes.

TABLE 16-13 TID G301

	NL	Relation with Parent	VT	Concept Name	VM	Req Type	Condition	Value Set Constraint
1			CONTAINER	EV (121070, DCM, 'Findings')	1	M		
2	>	HAS CONCEPT MOD	CODE	EV (G-C171, SRT, 'Laterality')	1	MC	IFF anatomy has laterality	DCID (244) Laterality
3	>	HAS CONCEPT MOD	CODE	EV (G-0373, SRT, 'Image Mode')	1	M		See Table 16-7 GE Ultrasound Modes
4	>	HAS CONCEPT MOD	CONTAINER	EV (GEU-1005-6, 99GEMS, 'User Vessel Anatomy') or (GEU-1005-3, 99GEMS, 'General Anatomy')	1	MC	IFF there exists user defined measurements	Note: User Vessel Anatomy mainly used to defined vessels and using Insert Study/Vessel template. General Anatomy mainly used in PWD and B-Mode and when user added individual folders and measurements.
5	>>	HAS CONCEPT MOD	TEXT	DT (GEU-1005-7, 99GEMS, 'Anatomy Label')	1	MC	IFF The container uses Finding as Concept Name	Labels from user which defined at configuration
6	>>	HAS CONCEPT MOD	CODE	EV (G-A1F8, SRT, Topographical modifier)	1	MC	IFF topographical defined	See Table 16-9 GE Ultrasound Vessel Location
7	>>	CONTAIN	INCLUDE	DTID (300) Measurement – see section: 16.1.7	1-n	M		\$Measurement = When 'Add Folder' insert study measurements by pre-populated study – Please refer to section 16.1.5. Vascular Ultrasound Measurement Group. When individually added 'Add Measurement' please refer to DCID (G5001) GE Defined Measurements since

								new measurement codes are determined by its measurement units \$Units = DCID (82) Units of Measurement \$Derivation = DCID (3627) Measurement Type \$Selection = DCID (224) Selection Method \$Label = Measurement Label created by User
--	--	--	--	--	--	--	--	---

16.1.12 Context ID G5001 GE Ultrasound Defined Measurement List

TABLE 16-14 CID G5001

distance-cm	cm	(121206, DCM, "Distance")
distance-mm	mm	(121206, DCM, "Distance")
volume-cm3	cm3	(G-D705, SRT, "Volume")
volume-mm3	mm3	(G-D705, SRT, "Volume")
frequency	kHz	(R-407E7, SRT, "Frequency")
frequency-h	Hz	(R-407E7, SRT, "Frequency")
area-cm2	cm2	(G-A166, SRT, "Area")
area-mm2	mm2	(G-A166, SRT, "Area")
time-s	s	(GEU-1004-22, 99GEMS, "Time")
time-ms	ms	(GEU-1004-22, 99GEMS, "Time")
time-min	min	(GEU-1004-22, 99GEMS, "Time")
volume-flow	ml/min	(33878-0, LN, "Volume Flow")
acceleration-index	cm/s2	(20167-3, LN, "Acceleration Index")
calculated-value	no units	(GEU-1004-7, 99GEMS, "Calculated Value")
angle	deg	(GEU-1004-18, 99GEMS, "Angle")
velocity	cm/s2	(GEU-1004-21, 99GEMS, "Velocity")
volume-gram	g	(G-D705, SRT, "Volume")
volume-ml	ml	(G-D705, SRT, "Volume")
velocity	cm/s	(GEU-1004-21, 99GEMS, "Velocity")
weekday	WeekDay	(GEU-1004-6, 99GEMS, "WeekDay")
date	Date	(GEU-1004-5, 99GEMS, "Date")
percent	%	(GEU-1004-4, 99GEMS, "Percent")
diameter-cm-m2	cm/m2	(GEU-1004-39, 99GEMS, "Diameter")
volume-index	ml/m2	(GEU-1004-40, 99GEMS, "Volume Index")
volume-flow-ml	ml/s	(33878-0, LN, "Volume Flow")
volume-flow-l	l/s	(33878-0, LN, "Volume Flow")
volume-flow-l-min	l/minm2	(33878-0, LN, "Volume Flow")
mass-flux	g/m2	(GEU-1004-42, 99GEMS, "Mass Flux")

16.2 ECHOCARDIOGRAPHY PROCEDURE REPORT

This section describes the contents of the Echocardiography Procedure Report (TID 5200) SR.

16.2.1 Echocardiography Structure

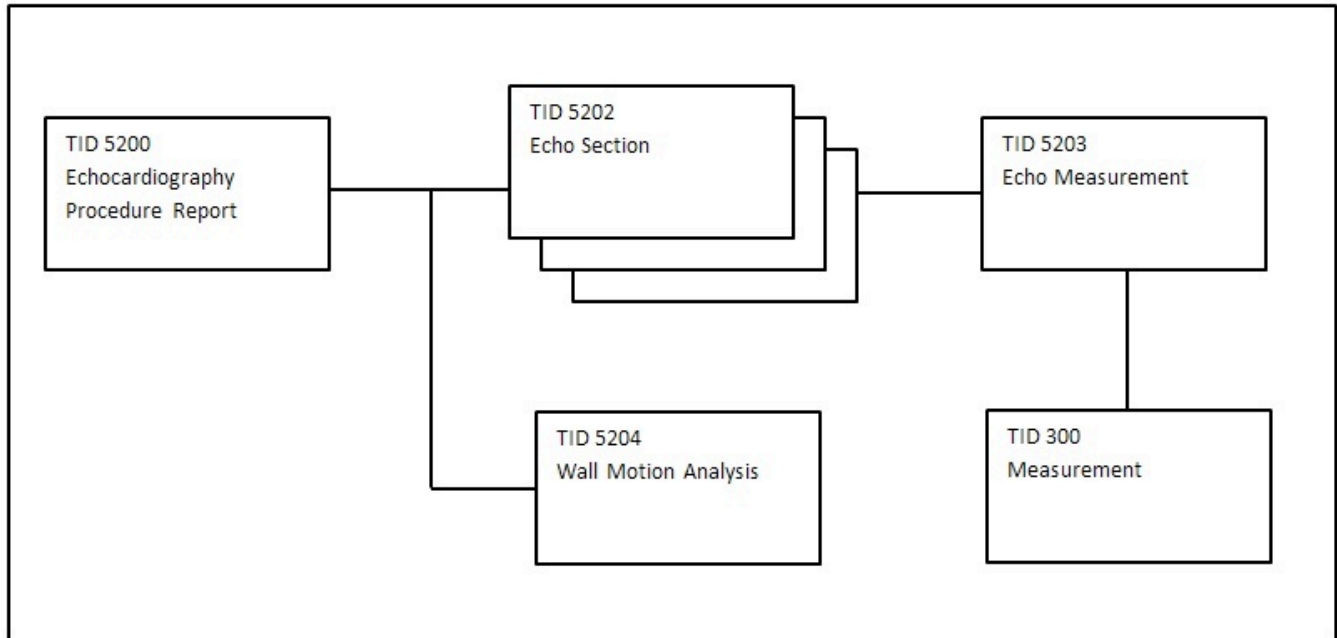

TID 5200 – Echocardiography Procedure Report

	NL	Rel with Parent	VT	Concept Name	VM	Req Type	Condition	Value Set Constraint
1			CONTAINER	EV (125200, DCM, "Adult Echocardiography Procedure Report")	1	M		
2		CONTAINS	INCLUDE	DTID (5202) Echo Section	1	U		\$SectionSubject = EV (T-32600, SRT, "Left Ventricle")
3		CONTAINS	INCLUDE	DTID (5202) Echo Section	1	U		\$SectionSubject = EV (T-32500, SRT, "Right Ventricle")
4		CONTAINS	INCLUDE	DTID (5202) Echo Section	1	U		\$SectionSubject = EV (T-32300, SRT, "Left Atrium")
5		CONTAINS	INCLUDE	DTID (5202) Echo Section	1	U		\$SectionSubject = EV (T-32200, SRT, "Right Atrium")
6		CONTAINS	INCLUDE	DTID (5202) Echo Section	1	U		\$SectionSubject = EV (T-35400, SRT, "Aortic Valve")

DIR DOC1585895 REV 2

7		CONTAINS	INCLUDE	DTID (5202) Echo Section	1	U		\$SectionSubject = EV (T-35300, SRT, "Mitral Valve")
8		CONTAINS	INCLUDE	DTID (5202) Echo Section	1	U		\$SectionSubject = EV (T-35200, SRT, "Pulmonic Valve")
9		CONTAINS	INCLUDE	DTID (5202) Echo Section	1	U		\$SectionSubject = EV (T-35100, SRT, "Tricuspid Valve")
10		CONTAINS	INCLUDE	DTID (5202) Echo Section	1	U		\$SectionSubject = EV (T-42000, SRT, "Aorta") \$MeasType= Error! Reference source not found.
11		CONTAINS	INCLUDE	DTID (5202) Echo Section	1	U		\$SectionSubject = EV (T-44000, SRT, "Pulmonary artery") \$MeasType =
12		CONTAINS	INCLUDE	DTID (5202) Echo Section	1	U		\$SectionSubject = EV (T-48600, SRT, "Vena Cava")
13		CONTAINS	INCLUDE	DTID (5202) Echo Section	1	U		\$SectionSubject = EV (T-48581, SRT, "Pulmonary Venous Structure")
14		CONTAINS	INCLUDE	DTID (5202) Echo Section	1	U		\$SectionSubject = EV (P5-30031, SRT, "Cardiac Shunt Study")
15		CONTAINS	INCLUDE	DTID (5202) Echo Section	1	U		\$SectionSubject = EV (D4-30000, SRT, "Congenital Anomaly of Cardiovascular System")
16		CONTAINS	INCLUDE	DTID (5204) Wall Motion Analysis	1-n	U		\$Procedure = DT (P5-B3121, SRT, "Echocardiography for Determining Ventricular Contraction")

16.2.2 Aorta

TABLE 16-15 AORTA

Name of GEU parameter	Base Measurement Concept Name	Concept or Acquisition Context Modifier
2D/Ao Diam SVals	(GEU-1005-45, 99GEMS, "Ao Diam SVals")	
2D/Ao Diam STub	(GEU-1005-46, 99GEMS, "Ao Diam STub")	

DIR DOC1585895 REV 2

MM/LAAo/Ao Root Diam	(18015-8, LN, "Aortic Root Diameter")	(G-0373, SRT, "Image Mode")=(G-0394, SRT, "M mode")
2D/Ao Root Diam	(18015-8, LN, "Aortic Root Diameter")	(G-0373, SRT, "Image Mode")=(G-03A2, SRT, "2D mode")
2D/Ao Asc Diam	(18012-5, LN, "Ascending Aortic Diameter")	(G-0373, SRT, "Image Mode")=(G-03A2, SRT, "2D mode")
2D/Ao st junct	(GEU-1005-40, 99GEMS, "Ao st junct")	(G-0373, SRT, "Image Mode")=(G-03A2, SRT, "2D mode")
2D/Ao Arch Diam	(18011-7, LN, "Aortic Arch Diameter")	(G-0373, SRT, "Image Mode")=(G-03A2, SRT, "2D mode")
2D/Ao Desc Diam	(18013-3, LN, "Descending Aortic Diameter")	(G-0373, SRT, "Image Mode")=(G-03A2, SRT, "2D mode")
2D/Ao Isthmus	(18014-1, LN, "Aortic Isthmus Diameter")	(G-0373, SRT, "Image Mode")=(G-03A2, SRT, "2D mode")
2D/Ao st junct/Ao	(GEU-1005-41, 99GEMS, "Ao st junct/Ao")	(G-0373, SRT, "Image Mode")=(G-03A2, SRT, "2D mode")
2D/LAX/Trans AoD diastole	(18015-8, LN, "Aortic Root Diameter")	(R-4089A, SRT, "Cardiac Cycle Point")=(F-32010, SRT, "Diastole") (G-0373, SRT, "Image Mode")=(G-03A2, SRT, "2D mode")
2D/LAX/Trans AoD systole	(18015-8, LN, "Aortic Root Diameter")	(R-4089A, SRT, "Cardiac Cycle Point")=(F-32020, SRT, "Systole") (G-0373, SRT, "Image Mode")=(G-03A2, SRT, "2D mode")
2D/SAX/Trans AoD diastole	(18015-8, LN, "Aortic Root Diameter")	(R-4089A, SRT, "Cardiac Cycle Point")=(F-32010, SRT, "Diastole") (G-0373, SRT, "Image Mode")=(G-03A2, SRT, "2D mode")
2D/SAX/Trans AoD systole	(18015-8, LN, "Aortic Root Diameter")	(R-4089A, SRT, "Cardiac Cycle Point")=(F-32020, SRT, "Systole") (G-0373, SRT, "Image Mode")=(G-03A2, SRT, "2D mode")
MM/Ao Root Diam	(18015-8, LN, "Aortic Root Diameter")	(G-0373, SRT, "Image Mode")=(G-0394, SRT, "M mode")
Asc Ao Vmax	(11726-7, LN, "Peak Velocity")	(G-C0E3, SRT, "Finding Site")=(T-42100, SRT, "Ascending aorta")
Asc Ao maxPG	(20247-3, LN, "Peak Gradient")	(G-C0E3, SRT, "Finding Site")=(T-42100, SRT, "Ascending aorta")
Dsc Ao Vmax	(11726-7, LN, "Peak Velocity")	(G-C0E3, SRT, "Finding Site")=(T-42400, SRT, "Descending aorta")
Dsc Ao maxPG	(20247-3, LN, "Peak Gradient")	(G-C0E3, SRT, "Finding Site")=(T-42400, SRT, "Descending aorta")

16.2.3 Aortic Valve

TABLE 16-16 AORTIC VALVE

Name of GEU parameter	Base Measurement Concept Name	Concept or Acquisition Context Modifier
2D/AVA/AV Diam	(G-038F, SRT, "Cardiovascular Orifice Diameter")	(G-C048, SRT, "Direction of Flow")=(R-42047, SRT, "Antegrade Flow") (G-0373, SRT, "Image Mode")=(G-03A2, SRT, "2D mode")
2D/AVA/AV Area	(G-038E, SRT, "Cardiovascular Orifice Area")	(G-C048, SRT, "Direction of Flow")=(R-42047, SRT, "Antegrade Flow") (G-0373, SRT, "Image Mode")=(G-03A2, SRT, "2D mode")
AV Dec Time	(20217-6, LN, "Deceleration Time")	(G-C048, SRT, "Direction of Flow")=(R-42047, SRT, "Antegrade Flow")
AV Dec Slope	(20216-8, LN, "Deceleration Slope")	(G-C048, SRT, "Direction of Flow")=(R-42047, SRT, "Antegrade Flow")
PISA/AR/RF	(G-0390, SRT, "Regurgitant Fraction")	(G-C036, SRT, "Measurement Method")=(125216, DCM, "Proximal Isovelocity Surface Area")
CFM/AR Signal Area	(G-038E, SRT, "Cardiovascular Orifice Area")	(G-C048, SRT, "Direction of Flow")=(R-42E61, SRT, "Regurgitant Flow") (G-0373, SRT, "Image Mode")=(R-409E2, SRT, "Doppler Color Flow")
MM/AV Diam	(G-038F, SRT, "Cardiovascular Orifice Diameter")	(G-C048, SRT, "Direction of Flow")=(R-42047, SRT, "Antegrade Flow") (G-0373, SRT, "Image Mode")=(G-0394, SRT, "M mode")
2D/AV Diam	(G-038F, SRT, "Cardiovascular Orifice Diameter")	(G-C048, SRT, "Direction of Flow")=(R-42047, SRT, "Antegrade Flow") (G-0373, SRT, "Image Mode")=(G-03A2, SRT, "2D mode")

DIR DOC1585895 REV 2

2D/AV Cusp	(17996-0, LN, "Aortic Valve Cusp Separation")	(G-0373, SRT, "Image Mode")=(G-03A2, SRT, "2D mode")
2D/LAX/Trans AVA diastole	(G-038E, SRT, "Cardiovascular Orifice Area")	(R-4089A, SRT, "Cardiac Cycle Point")=(F-32010, SRT, "Diastole") (G-0373, SRT, "Image Mode")=(G-03A2, SRT, "2D mode")
2D/LAX/Trans AVA systole	(G-038E, SRT, "Cardiovascular Orifice Area")	(R-4089A, SRT, "Cardiac Cycle Point")=(F-32020, SRT, "Systole") (G-0373, SRT, "Image Mode")=(G-03A2, SRT, "2D mode")
2D/SAX/Trans AVA diastole	(G-038E, SRT, "Cardiovascular Orifice Area")	(R-4089A, SRT, "Cardiac Cycle Point")=(F-32010, SRT, "Diastole") (G-0373, SRT, "Image Mode")=(G-03A2, SRT, "2D mode")
2D/SAX/Trans AVA systole	(G-038E, SRT, "Cardiovascular Orifice Area")	(R-4089A, SRT, "Cardiac Cycle Point")=(F-32020, SRT, "Systole") (G-0373, SRT, "Image Mode")=(G-03A2, SRT, "2D mode")
2D/AVA Planimetry	(G-038E, SRT, "Cardiovascular Orifice Area")	(G-C048, SRT, "Direction of Flow")=(R-42047, SRT, "Antegrade Flow") (G-0373, SRT, "Image Mode")=(G-03A2, SRT, "2D mode") (G-C036, SRT, "Measurement Method")=(125220, DCM, "Planimetry")
2D/AV Area	(G-038E, SRT, "Cardiovascular Orifice Area")	(G-C048, SRT, "Direction of Flow")=(R-42047, SRT, "Antegrade Flow") (G-0373, SRT, "Image Mode")=(G-03A2, SRT, "2D mode")
MM/AV Cusp	(17996-0, LN, "Aortic Valve Cusp Separation")	(G-0373, SRT, "Image Mode")=(G-0394, SRT, "M mode")
AV Vmax	(11726-7, LN, "Peak Velocity")	(G-C048, SRT, "Direction of Flow")=(R-42047, SRT, "Antegrade Flow")
AV Vmax P	(11726-7, LN, "Peak Velocity")	(G-C048, SRT, "Direction of Flow")=(R-42047, SRT, "Antegrade Flow")
AV maxPG	(20247-3, LN, "Peak Gradient")	(G-C048, SRT, "Direction of Flow")=(R-42047, SRT, "Antegrade Flow")
AV Vmean	(20352-1, LN, "Mean Velocity")	(G-C048, SRT, "Direction of Flow")=(R-42047, SRT, "Antegrade Flow")
AV meanPG	(20256-4, LN, "Mean Gradient")	(G-C048, SRT, "Direction of Flow")=(R-42047, SRT, "Antegrade Flow")
AV Acc Time	(20168-1, LN, "Acceleration Time")	(G-C048, SRT, "Direction of Flow")=(R-42047, SRT, "Antegrade Flow")
AV VTI	(20354-7, LN, "Velocity Time Integral")	(G-C048, SRT, "Direction of Flow")=(R-42047, SRT, "Antegrade Flow")
AVA (VTI)	(G-038E, SRT, "Cardiovascular Orifice Area")	(G-C048, SRT, "Direction of Flow")=(R-42047, SRT, "Antegrade Flow") (G-C036, SRT, "Measurement Method")=(125215, DCM, "Continuity Equation by Velocity Time Integral")
AVA (Vmax)	(G-038E, SRT, "Cardiovascular Orifice Area")	(G-C048, SRT, "Direction of Flow")=(R-42047, SRT, "Antegrade Flow") (G-C036, SRT, "Measurement Method")=(125214, DCM, "Continuity Equation by Peak Velocity")
AVA (Vmax)2	(G-038E, SRT, "Cardiovascular Orifice Area")	(G-C048, SRT, "Direction of Flow")=(R-42047, SRT, "Antegrade Flow") (G-C036, SRT, "Measurement Method")=(125214, DCM, "Continuity Equation by Peak Velocity")
AVA (Vmax)P	(G-038E, SRT, "Cardiovascular Orifice Area")	(G-C048, SRT, "Direction of Flow")=(R-42047, SRT, "Antegrade Flow") (G-C036, SRT, "Measurement Method")=(125214, DCM, "Continuity Equation by Peak Velocity")
AVA (Vmax)P2	(G-038E, SRT, "Cardiovascular Orifice Area")	(G-C048, SRT, "Direction of Flow")=(R-42047, SRT, "Antegrade Flow") (G-C036, SRT, "Measurement Method")=(125214, DCM, "Continuity Equation by Peak Velocity")
AV Env.Ti	(GEU-1005-34, 99GEMS, "AV Env.Ti")	

DIR DOC1585895 REV 2

AV SV	(F-32120, SRT, "Stroke Volume")	(G-C0E3, SRT, "Finding Site")=(T-42000, SRT, "Aorta")
AV HR	(8867-4, LN, "Heart rate")	
AV SI	(F-00078, SRT, "Stroke Index")	(G-C0E3, SRT, "Finding Site")=(T-42000, SRT, "Aorta")
AV CO	(F-32100, SRT, "Cardiac Output")	(G-C0E3, SRT, "Finding Site")=(T-42000, SRT, "Aorta")
AV CI	(F-32110, SRT, "Cardiac Index")	(G-C0E3, SRT, "Finding Site")=(T-42000, SRT, "Aorta")
AVA/AV Vmax	(11726-7, LN, "Peak Velocity")	(G-C048, SRT, "Direction of Flow")=(R-42047, SRT, "Antegrade Flow")
AVA/AV Vmax P	(11726-7, LN, "Peak Velocity")	(G-C048, SRT, "Direction of Flow")=(R-42047, SRT, "Antegrade Flow")
AVA/AV maxPG	(20247-3, LN, "Peak Gradient")	(G-C048, SRT, "Direction of Flow")=(R-42047, SRT, "Antegrade Flow")
AVA/AV Vmean	(20352-1, LN, "Mean Velocity")	(G-C048, SRT, "Direction of Flow")=(R-42047, SRT, "Antegrade Flow")
AVA/AV meanPG	(20256-4, LN, "Mean Gradient")	(G-C048, SRT, "Direction of Flow")=(R-42047, SRT, "Antegrade Flow")
AVA/AV VTI	(20354-7, LN, "Velocity Time Integral")	(G-C048, SRT, "Direction of Flow")=(R-42047, SRT, "Antegrade Flow")
AVA/AVA (VTI)	(G-038E, SRT, "Cardiovascular Orifice Area")	(G-C048, SRT, "Direction of Flow")=(R-42047, SRT, "Antegrade Flow") (G-C036, SRT, "Measurement Method")=(125215, DCM, "Continuity Equation by Velocity Time Integral")
AVA/AVA (Vmax)	(G-038E, SRT, "Cardiovascular Orifice Area")	(G-C048, SRT, "Direction of Flow")=(R-42047, SRT, "Antegrade Flow") (G-C036, SRT, "Measurement Method")=(125214, DCM, "Continuity Equation by Peak Velocity")
AVA/AVA (Vmax)2	(G-038E, SRT, "Cardiovascular Orifice Area")	(G-C048, SRT, "Direction of Flow")=(R-42047, SRT, "Antegrade Flow") (G-C036, SRT, "Measurement Method")=(125214, DCM, "Continuity Equation by Peak Velocity")
AVA/AVA (Vmax)P	(G-038E, SRT, "Cardiovascular Orifice Area")	(G-C048, SRT, "Direction of Flow")=(R-42047, SRT, "Antegrade Flow") (G-C036, SRT, "Measurement Method")=(125214, DCM, "Continuity Equation by Peak Velocity")
AVA/AVA (Vmax)P2	(G-038E, SRT, "Cardiovascular Orifice Area")	(G-C048, SRT, "Direction of Flow")=(R-42047, SRT, "Antegrade Flow") (G-C036, SRT, "Measurement Method")=(125214, DCM, "Continuity Equation by Peak Velocity")
AVA/AV Env.Ti	(GEU-1005-35, 99GEMS, "AVA/AV Env.Ti")	
AVA/AV SV	(F-32120, SRT, "Stroke Volume")	(G-C0E3, SRT, "Finding Site")=(T-42000, SRT, "Aorta")
AVA/AV HR	(8867-4, LN, "Heart rate")	
AVA/AV SI	(F-00078, SRT, "Stroke Index")	(G-C0E3, SRT, "Finding Site")=(T-42000, SRT, "Aorta")
AVA/AV CO	(F-32100, SRT, "Cardiac Output")	(G-C0E3, SRT, "Finding Site")=(T-42000, SRT, "Aorta")
AVA/AV CI	(F-32110, SRT, "Cardiac Index")	(G-C0E3, SRT, "Finding Site")=(T-42000, SRT, "Aorta")
AV Acc Slope	(20174-9, LN, "Aortic Valve Acceleration Slope")	
AVET	(18041-4, LN, "Aortic Valve Ejection Time")	
AV Acc Time/ET Ratio	(G-0382, SRT, "Ratio of Aortic Valve Acceleration Time to Ejection Time")	
AV dp/dt	(GEU-1005-156, 99GEMS, "AV dp/dt")	
AV Time To Peak	(59121-4, LN, "Time to Peak by US")	
AR PHT	(20280-4, LN, "Pressure Half-Time")	(G-C048, SRT, "Direction of Flow")=(R-42E61, SRT, "Regurgitant Flow")

DIR DOC1585895 REV 2

AR Dec Time	(20217-6, LN, "Deceleration Time")	(G-C048, SRT, "Direction of Flow")= (R-42E61, SRT, "Regurgitant Flow")
AR Dec Slope	(20216-8, LN, "Deceleration Slope")	(G-C048, SRT, "Direction of Flow")= (R-42E61, SRT, "Regurgitant Flow")
AR Vmax	(11726-7, LN, "Peak Velocity")	(G-C048, SRT, "Direction of Flow")= (R-42E61, SRT, "Regurgitant Flow")
AR maxPG	(20247-3, LN, "Peak Gradient")	(G-C048, SRT, "Direction of Flow")= (R-42E61, SRT, "Regurgitant Flow")
ARend Vmax	(18026-5, LN, "End Diastolic Velocity")	(G-C048, SRT, "Direction of Flow")= (R-42E61, SRT, "Regurgitant Flow")
ARend maxPG	(20247-3, LN, "Peak Gradient")	(G-C048, SRT, "Direction of Flow")= (R-42E61, SRT, "Regurgitant Flow") (R-4089A, SRT, "Cardiac Cycle Point")= (109022, DCM, "End Diastole")
AR Vmean	(20352-1, LN, "Mean Velocity")	(G-C048, SRT, "Direction of Flow")= (R-42E61, SRT, "Regurgitant Flow")
AR meanPG	(20256-4, LN, "Mean Gradient")	(G-C048, SRT, "Direction of Flow")= (R-42E61, SRT, "Regurgitant Flow")
AR Env.Ti	(59108-1, LN, "Envelope Duration")	
AR VTI	(20354-7, LN, "Velocity Time Integral")	(G-C048, SRT, "Direction of Flow")= (R-42E61, SRT, "Regurgitant Flow")
AR dp/dt	(GEU-1005-155, 99GEMS, "AR dp/dt")	
AP VTI	(20354-7, LN, "Velocity Time Integral")	
AP Area	(GEU-1005-131, 99GEMS, "AP Area")	
PISA/AR/Flow	(34141-2, LN, "Peak Instantaneous Flow Rate")	(G-C048, SRT, "Direction of Flow")= (R-42E61, SRT, "Regurgitant Flow") (G-C036, SRT, "Measurement Method")= (125216, DCM, "Proximal Isovelocity Surface Area")
PISA/AR/Vmax	(11726-7, LN, "Peak Velocity")	(G-C048, SRT, "Direction of Flow")= (R-42E61, SRT, "Regurgitant Flow") (G-C036, SRT, "Measurement Method")= (125216, DCM, "Proximal Isovelocity Surface Area")
PISA/AR/VTI	(20354-7, LN, "Velocity Time Integral")	(G-C048, SRT, "Direction of Flow")= (R-42E61, SRT, "Regurgitant Flow") (G-C036, SRT, "Measurement Method")= (125216, DCM, "Proximal Isovelocity Surface Area")
PISA/AR/ERO	(G-038E, SRT, "Cardiovascular Orifice Area")	(G-C048, SRT, "Direction of Flow")= (R-42E61, SRT, "Regurgitant Flow") (G-C036, SRT, "Measurement Method")= (125216, DCM, "Proximal Isovelocity Surface Area")
PISA/AR/RV	(33878-0, LN, "Volume Flow")	(G-C048, SRT, "Direction of Flow")= (R-42E61, SRT, "Regurgitant Flow") (G-C036, SRT, "Measurement Method")= (125216, DCM, "Proximal Isovelocity Surface Area")
AR HR	(8867-4, LN, "Heart rate")	(G-0373, SRT, "Image Mode")= (R-409E4, SRT, "Doppler Pulsed")

16.2.4 Congenital Anomaly of Cardiovascular System

TABLE 16-17 CONGENITAL ANOMALY OF CARDIOVASCULAR SYSTEM

Name of GEU parameter	Base Measurement Concept Name	Concept or Acquisition Context Modifier
2D/PDA Diam	(GEU-1005-81, 99GEMS, "PDA Diam")	(G-0373, SRT, "Image Mode")= (G-03A2, SRT, "2D mode")
2D/ASD Diam	(G-038F, SRT, "Cardiovascular Orifice Diameter")	(G-0373, SRT, "Image Mode")= (G-03A2, SRT, "2D mode") (G-C0E3, SRT, "Finding Site")= (D4-31220, SRT, "Atrial Septal Defect")

DIR DOC1585895 REV 2

2D/VSD Diam	(G-038F, SRT, "Cardiovascular Orifice Diameter")	(G-0373, SRT, "Image Mode")= (G-03A2, SRT, "2D mode") (G-C0E3, SRT, "Finding Site")= (D4-31150, SRT, "Ventricular Septal Defect")
2D/PFO Diam	(GEU-1005-82, 99GEMS, "PFO Diam")	(G-0373, SRT, "Image Mode")= (G-03A2, SRT, "2D mode")
2D/Pre Ductal	(GEU-1005-84, 99GEMS, "Pre Ductal")	(G-0373, SRT, "Image Mode")= (G-03A2, SRT, "2D mode") See *1
2D/Post Ductal	(GEU-1005-83, 99GEMS, "Post Ductal")	(G-0373, SRT, "Image Mode")= (G-03A2, SRT, "2D mode") See *2
VSD Vmax	(11726-7, LN, "Peak Velocity")	(G-C0E3, SRT, "Finding Site")= (D4-31150, SRT, "Ventricular Septal Defect")
VSD maxPG	(20247-3, LN, "Peak Gradient")	(G-C0E3, SRT, "Finding Site")= (D4-31150, SRT, "Ventricular Septal Defect")
ASD Vmax	(11726-7, LN, "Peak Velocity")	(G-C0E3, SRT, "Finding Site")= (D4-31220, SRT, "Atrial Septal Defect")
ASD maxPG	(20247-3, LN, "Peak Gradient")	(G-C0E3, SRT, "Finding Site")= (D4-31220, SRT, "Atrial Septal Defect")
PDA Systolic	(GEU-1005-100, 99GEMS, "PDA Systolic")	
PDA Systolic PG	(GEU-1005-101, 99GEMS, "PDA Systolic PG")	
PDA Diastolic	(GEU-1005-102, 99GEMS, "PDA Diastolic")	
PDA Diastolic PG	(GEU-1005-103, 99GEMS, "PDA Diastolic PG")	
Coarctation/Pre-Ductal	(GEU-1005-98, 99GEMS, "Coarctation/Pre-Ductal")	See *1
Coarctation/Pre-Ductal PG	(GEU-1005-99, 99GEMS, "Coarctation/Pre-Ductal PG")	See *1
Coarctation/Post-Ductal	(GEU-1005-96, 99GEMS, "Coarctation/Post-Ductal")	See *2
Coarctation/Post-Ductal PG	(GEU-1005-97, 99GEMS, "Coarctation/Post-Ductal PG")	See *2

*1: Pre Ductal means the narrowing is proximal to the ductus arteriosus.

*2: Post Ductal means the narrowing is distal to the insertion of the ductus arteriosus.

16.2.5 Cardiac Shunt Study

TABLE 16-18 CARDIAC SHUNT STUDY

Name of GEU parameter	Base Measurement Concept Name	Concept or Acquisition Context Modifier
Systemic HR	(GEU-1005-152, 99GEMS, "Systemic HR")	Left Ventricular HR
Systemic SV	(GEU-1005-95, 99GEMS, "Systemic SV")	Left Ventricular SV
Systemic CO	(GEU-1005-94, 99GEMS, "Systemic CO")	Left Ventricular CO
Pulmonic HR	(GEU-1005-151, 99GEMS, "Pulmonic HR")	Right Ventricular HR
Pulmonic SV	(GEU-1005-93, 99GEMS, "Pulmonic SV")	Right Ventricular SV
Pulmonic CO	(GEU-1005-92, 99GEMS, "Pulmonic CO")	Right Ventricular CO
2D/Pulmonic Diam	(GEU-1005-150, 99GEMS, "Pulmonic Diam")	(G-0373, SRT, "Image Mode")= (G-03A2, SRT, "2D mode")
2D/Systemic Diam	(GEU-1005-149, 99GEMS, "Systemic Diam")	(G-0373, SRT, "Image Mode")= (G-03A2, SRT, "2D mode")
Qp/Qs	(29462-9, LN, "Pulmonary-to-Systemic Shunt Flow Ratio")	
Systemic Vmax	(GEU-1005-120, 99GEMS, "Systemic Vmax")	Left Ventricular Vmax
Systemic Vmean	(GEU-1005-121, 99GEMS, "Systemic Vmean")	Left Ventricular Vmean
Systemic maxPG	(GEU-1005-117, 99GEMS, "Systemic maxPG")	Left Ventricular maxPG
Systemic meanPG	(GEU-1005-118, 99GEMS, "Systemic meanPG")	Left Ventricular meanPG
Systemic Env.Ti	(GEU-1005-116, 99GEMS, "Systemic Env.Ti")	Left Ventricular Env.Ti
Systemic VTI	(GEU-1005-44, 99GEMS, "Systemic VTI")	Left Ventricular VTI

DIR DOC1585895 REV 2

Pulmonic Vmax	(GEU-1005-112, 99GEMS, "Pulmonic Vmax")	Right Ventricular Vmax
Pulmonic Vmean	(GEU-1005-113, 99GEMS, "Pulmonic Vmean")	Right Ventricular Vmean
Pulmonic maxPG	(GEU-1005-110, 99GEMS, "Pulmonic maxPG")	Right Ventricular maxPG
Pulmonic meanPG	(GEU-1005-111, 99GEMS, "Pulmonic meanPG")	Right Ventricular meanPG
Pulmonic Env.Ti	(GEU-1005-109, 99GEMS, "Pulmonic Env.Ti")	Right Ventricular Env.Ti
Pulmonic VTI	(GEU-1005-43, 99GEMS, "Pulmonic VTI")	Right Ventricular VTI

16.2.6 Left Atrium

TABLE 16-19 LEFT ATRIUM

Name of GEU parameter	Base Measurement Concept Name	Concept or Acquisition Context Modifier
2D/Ao/LA	(17985-3, LN, "Left Atrium to Aortic Root Ratio")	(G-0373, SRT, "Image Mode")= (G-03A2, SRT, "2D mode")
2D/LA D1	(GEU-1005-59, 99GEMS, "LA D1")	
2D/LA D2	(GEU-1005-60, 99GEMS, "LA D2")	
2D/LA D3	(GEU-1005-61, 99GEMS, "LA D3")	
2D/LA Volume	(GEU-1005-62, 99GEMS, "LA Volume")	
MM/Ao/LA	(17985-3, LN, "Left Atrium to Aortic Root Ratio")	(G-0373, SRT, "Image Mode")= (G-0394, SRT, "M mode")
MM/LA	(29469-4, LN, "Left Atrium Antero-posterior Systolic Dimension")	(G-0373, SRT, "Image Mode")= (G-0394, SRT, "M mode")
MM/LAAo/LA	(29469-4, LN, "Left Atrium Antero-posterior Systolic Dimension")	(G-0373, SRT, "Image Mode")= (G-0394, SRT, "M mode")
MM/LAAo/LA/Ao	(17985-3, LN, "Left Atrium to Aortic Root Ratio")	(G-0373, SRT, "Image Mode")= (G-0394, SRT, "M mode")
MM/LAAo/Ao/LA	(17985-3, LN, "Left Atrium to Aortic Root Ratio")	(G-0373, SRT, "Image Mode")= (G-0394, SRT, "M mode")
SD/LAappendix Vmax	(11726-7, LN, "Peak Velocity")	
2D/LA Volume Index	(GEU-1005-63, 99GEMS, "LA Volume Index")	
2D/LA Major	(G-A193, SRT, "Major Axis")	(G-0373, SRT, "Image Mode")= (G-03A2, SRT, "2D mode")
2D/LA Minor	(G-A194, SRT, "Minor Axis")	(G-0373, SRT, "Image Mode")= (G-03A2, SRT, "2D mode")
2D/LA	(29469-4, LN, "Left Atrium Antero-posterior Systolic Dimension")	
2D/LA/Ao	(17985-3, LN, "Left Atrium to Aortic Root Ratio")	(G-0373, SRT, "Image Mode")= (G-03A2, SRT, "2D mode")
2D/LAA diastole	(GEU-1005-69, 99GEMS, "LAA diastole")	(G-0373, SRT, "Image Mode")= (G-03A2, SRT, "2D mode")
2D/LAA systole	(17977-0, LN, "Left Atrium Systolic Area")	(G-0373, SRT, "Image Mode")= (G-03A2, SRT, "2D mode")
2D/LA Area	(G-A166, SRT, "Area")	(G-0373, SRT, "Image Mode")= (G-03A2, SRT, "2D mode")
LALd(A4C)	(29467-8, LN, "Left Atrium Superior-Inferior Dimension, 4-chamber view")	(R-4089A, SRT, "Cardiac Cycle Point")= (F-32010, SRT, "Diastole")
LAAAd(A4C)	(GEU-1005-49, 99GEMS, "LAAAd(A4C)")	
LAEDV(A-L A4C)	(GEU-1005-54, 99GEMS, "LAEDV(A-L A4C)")	
LAESV(A-L A4C)	(G-0383, SRT, "Left Atrium Systolic Volume")	(111031, DCM, "Image View")= (G-A19C, SRT, "Apical four chamber") (G-C036, SRT, "Measurement Method")= (125205, DCM, "Area-Length Single Plane")
LAEDV(MOD A4C)	(GEU-1005-56, 99GEMS, "LAEDV(MOD A4C)")	

DIR DOC1585895 REV 2

LALs(A4C)	(29467-8, LN, "Left Atrium Superior-Inferior Dimension, 4-chamber view")	
LAAAs(A4C)	(GEU-1005-51, 99GEMS, "LAAAs(A4C)")	(111031, DCM, "Image View")= (G-A19C, SRT, "Apical four chamber")
LAESV(MOD A4C)	(G-0383, SRT, "Left Atrium Systolic Volume")	(111031, DCM, "Image View")= (G-A19C, SRT, "Apical four chamber") (G-C036, SRT, "Measurement Method")= (125208, DCM, "Method of Disks, Single Plane")
LALd(A2C)	(GEU-1005-48, 99GEMS, "LALd(A2C)")	
LAAAd(A2C)	(GEU-1005-47, 99GEMS, "LAAAd(A2C)")	
LAEDV(A-L A2C)	(GEU-1005-53, 99GEMS, "LAEDV(A-L A2C)")	
LAEDV(MOD A2C)	(GEU-1005-55, 99GEMS, "LAEDV(MOD A2C)")	
LALs(A2C)	(GEU-1005-52, 99GEMS, "LALs(A2C)")	
LAAAs(A2C)	(GEU-1005-50, 99GEMS, "LAAAs(A2C)")	(111031, DCM, "Image View")= (G-A19B, SRT, "Apical two chamber")
LAESV(A-L A2C)	(G-0383, SRT, "Left Atrium Systolic Volume")	(111031, DCM, "Image View")= (G-A19B, SRT, "Apical two chamber") (G-C036, SRT, "Measurement Method")= (125205, DCM, "Area-Length Single Plane")
LAESV(MOD A2C)	(G-0383, SRT, "Left Atrium Systolic Volume")	(111031, DCM, "Image View")= (G-A19B, SRT, "Apical two chamber") (G-C036, SRT, "Measurement Method")= (125208, DCM, "Method of Disks, Single Plane")
MM/LA/Ao	(17985-3, LN, "Left Atrium to Aortic Root Ratio")	(G-0373, SRT, "Image Mode")= (G-0394, SRT, "M mode")
2D/LAEDV(A-L)	(122407, DCM, "Left Atrial End Diastolic Volume")	(G-0373, SRT, "Image Mode")= (G-03A2, SRT, "2D mode") (G-C036, SRT, "Measurement Method")= (125204, DCM, "Area-Length Biplane")
2D/LAESV(A-L)	(G-0383, SRT, "Left Atrium Systolic Volume")	(G-0373, SRT, "Image Mode")= (G-03A2, SRT, "2D mode") (G-C036, SRT, "Measurement Method")= (125204, DCM, "Area-Length Biplane")

16.2.7 Left Ventricle

TABLE 16-20 LEFT VENTRICLE

Name of GEU parameter	Base Measurement Concept Name	Concept or Acquisition Context Modifier
CO(A-L)	(F-32100, SRT, "Cardiac Output")	(G-C036, SRT, "Measurement Method")= (125205, DCM, "Area-Length Single Plane")
CO(A-L A4C)/AutoHR	(F-32100, SRT, "Cardiac Output")	(111031, DCM, "Image View")= (G-A19C, SRT, "Apical four chamber") (G-C036, SRT, "Measurement Method")= (125205, DCM, "Area-Length Single Plane")
CI(A-L A4C)/AutoHR	(F-32110, SRT, "Cardiac Index")	(111031, DCM, "Image View")= (G-A19C, SRT, "Apical four chamber") (G-C036, SRT, "Measurement Method")= (125205, DCM, "Area-Length Single Plane")
CO(MOD A4C)/AutoHR	(F-32100, SRT, "Cardiac Output")	(111031, DCM, "Image View")= (G-A19C, SRT, "Apical four chamber") (G-C036, SRT, "Measurement Method")= (125208, DCM, "Method of Disks, Single Plane")
CI(MOD A4C)/AutoHR	(F-32110, SRT, "Cardiac Index")	(111031, DCM, "Image View")= (G-A19C, SRT, "Apical four chamber") (G-C036, SRT, "Measurement Method")= (125208, DCM, "Method of Disks, Single Plane")

DIR DOC1585895 REV 2

CO(A-L A2C)/AutoHR	(F-32100, SRT, "Cardiac Output")	(111031, DCM, "Image View")= (G-A19B, SRT, "Apical two chamber") (G-C036, SRT, "Measurement Method")= (125205, DCM, "Area-Length Single Plane")
CI(A-L A2C)/AutoHR	(F-32110, SRT, "Cardiac Index")	(111031, DCM, "Image View")= (G-A19B, SRT, "Apical two chamber") (G-C036, SRT, "Measurement Method")= (125205, DCM, "Area-Length Single Plane")
CO(MOD A2C)/AutoHR	(F-32100, SRT, "Cardiac Output")	(111031, DCM, "Image View")= (G-A19B, SRT, "Apical two chamber") (G-C036, SRT, "Measurement Method")= (125208, DCM, "Method of Disks, Single Plane")
CI(MOD A2C)/AutoHR	(F-32110, SRT, "Cardiac Index")	(111031, DCM, "Image View")= (G-A19B, SRT, "Apical two chamber") (G-C036, SRT, "Measurement Method")= (125208, DCM, "Method of Disks, Single Plane")
CO(A-L LAX)/AutoHR	(F-32100, SRT, "Cardiac Output")	(111031, DCM, "Image View")= (G-0395, SRT, "Apical long axis") (G-C036, SRT, "Measurement Method")= (125205, DCM, "Area-Length Single Plane")
CI(A-L LAX)/AutoHR	(F-32110, SRT, "Cardiac Index")	(111031, DCM, "Image View")= (G-0395, SRT, "Apical long axis") (G-C036, SRT, "Measurement Method")= (125205, DCM, "Area-Length Single Plane")
CO(MOD LAX)/AutoHR	(F-32100, SRT, "Cardiac Output")	(111031, DCM, "Image View")= (G-0395, SRT, "Apical long axis") (G-C036, SRT, "Measurement Method")= (125208, DCM, "Method of Disks, Single Plane")
CI(MOD LAX)/AutoHR	(F-32110, SRT, "Cardiac Index")	(111031, DCM, "Image View")= (G-0395, SRT, "Apical long axis") (G-C036, SRT, "Measurement Method")= (125208, DCM, "Method of Disks, Single Plane")
LVEDV(MOD BP) 03	(18026-5, LN, "Left Ventricular End Diastolic Volume")	(G-C036, SRT, "Measurement Method")= (125207, DCM, "Method of Disks, Biplane")
LVESV(MOD BP) 03	(18148-7, LN, "Left Ventricular End Systolic Volume")	(G-C036, SRT, "Measurement Method")= (125207, DCM, "Method of Disks, Biplane")
EF(Biplane) 03	(18043-0, LN, "Left Ventricular Ejection Fraction")	(G-C036, SRT, "Measurement Method")= (125207, DCM, "Method of Disks, Biplane")
SV(Biplane) 03	(F-32120, SRT, "Stroke Volume")	(G-C036, SRT, "Measurement Method")= (125207, DCM, "Method of Disks, Biplane")
SI(Biplane) 03	(F-00078, SRT, "Stroke Index")	(G-C036, SRT, "Measurement Method")= (125207, DCM, "Method of Disks, Biplane")
CO(Biplane) 03	(F-32100, SRT, "Cardiac Output")	(G-C036, SRT, "Measurement Method")= (125207, DCM, "Method of Disks, Biplane")
CI(Biplane) 03	(F-32110, SRT, "Cardiac Index")	(G-C036, SRT, "Measurement Method")= (125207, DCM, "Method of Disks, Biplane")
ECG/HeartRate/Auto	(8867-4, LN, "Heart rate")	
2D/LV Major	(G-A193, SRT, "Major Axis")	(G-0373, SRT, "Image Mode")= (G-03A2, SRT, "2D mode")
2D/LV Minor	(G-A194, SRT, "Minor Axis")	(G-0373, SRT, "Image Mode")= (G-03A2, SRT, "2D mode")
2D/IVSd	(18154-5, LN, "Interventricular Septum Diastolic Thickness")	(G-0373, SRT, "Image Mode")= (G-03A2, SRT, "2D mode")
2D/LVIDd	(29436-3, LN, "Left Ventricle Internal End Diastolic Dimension")	(G-0373, SRT, "Image Mode")= (G-03A2, SRT, "2D mode")
2D/LVIDd Index	(GEU-1005-139, 99GEMS, "LVIDd Index")	(G-0373, SRT, "Image Mode")= (G-03A2, SRT, "2D mode")
2D/LVIDs	(29438-9, LN, "Left Ventricle Internal Systolic Dimension")	(G-0373, SRT, "Image Mode")= (G-03A2, SRT, "2D mode")
2D/LVIDs Index	(GEU-106-0029, 99GEMS, "Left Ventricle Internal Systolic Dimension Index")	(G-0373, SRT, "Image Mode")= (G-03A2, SRT, "2D mode")

2D/LVPWd	(18152-9, LN, "Left Ventricle Posterior Wall Diastolic Thickness")	(G-0373, SRT, "Image Mode")=(G-03A2, SRT, "2D mode")
2D/LVPWs	(18156-0, LN, "Left Ventricle Posterior Wall Systolic Thickness")	(G-0373, SRT, "Image Mode")=(G-03A2, SRT, "2D mode")
2D/IVSs	(18158-6, LN, "Interventricular Septum Systolic Thickness")	(G-0373, SRT, "Image Mode")=(G-03A2, SRT, "2D mode")
2D/LVOT Diam	(G-038F, SRT, "Cardiovascular Orifice Diameter")	(G-0373, SRT, "Image Mode")=(G-03A2, SRT, "2D mode") (G-C0E3, SRT, "Finding Site")=(T-32650, SRT, "Left Ventricular Outflow Tract")
2D/AVA/LVOT Diam	(G-038F, SRT, "Cardiovascular Orifice Diameter")	(G-0373, SRT, "Image Mode")=(G-03A2, SRT, "2D mode") (G-C0E3, SRT, "Finding Site")=(T-32650, SRT, "Left Ventricular Outflow Tract")
2D/AVA/LVOT Area	(G-038E, SRT, "Cardiovascular Orifice Area")	(G-0373, SRT, "Image Mode")=(G-03A2, SRT, "2D mode") (G-C0E3, SRT, "Finding Site")=(T-32650, SRT, "Left Ventricular Outflow Tract")
2D/EDV(Teich)	(18026-5, LN, "Left Ventricular End Diastolic Volume")	(G-0373, SRT, "Image Mode")=(G-03A2, SRT, "2D mode") (G-C036, SRT, "Measurement Method")=(125209, DCM, "Teichholz")
2D/ESV(Teich)	(18148-7, LN, "Left Ventricular End Systolic Volume")	(G-0373, SRT, "Image Mode")=(G-03A2, SRT, "2D mode") (G-C036, SRT, "Measurement Method")=(125209, DCM, "Teichholz")
2D/EF(Teich)	(18043-0, LN, "Left Ventricular Ejection Fraction")	(G-0373, SRT, "Image Mode")=(G-03A2, SRT, "2D mode") (G-C036, SRT, "Measurement Method")=(125209, DCM, "Teichholz")
2D/EDV(Cube)	(18026-5, LN, "Left Ventricular End Diastolic Volume")	(G-0373, SRT, "Image Mode")=(G-03A2, SRT, "2D mode") (G-C036, SRT, "Measurement Method")=(125206, DCM, "Cube Method")
2D/ESV(Cube)	(18148-7, LN, "Left Ventricular End Systolic Volume")	(G-0373, SRT, "Image Mode")=(G-03A2, SRT, "2D mode") (G-C036, SRT, "Measurement Method")=(125206, DCM, "Cube Method")
2D/EF(Cube)	(18043-0, LN, "Left Ventricular Ejection Fraction")	(G-0373, SRT, "Image Mode")=(G-03A2, SRT, "2D mode") (G-C036, SRT, "Measurement Method")=(125206, DCM, "Cube Method")
2D/%FS	(18051-3, LN, "Left Ventricular Fractional Shortening")	(G-0373, SRT, "Image Mode")=(G-03A2, SRT, "2D mode")
2D/%IVS Thck	(18054-7, LN, "Interventricular Septum % Thickening")	(G-0373, SRT, "Image Mode")=(G-03A2, SRT, "2D mode")
2D/%LVPW Thck	(18053-9, LN, "Left Ventricle Posterior Wall % Thickening")	(G-0373, SRT, "Image Mode")=(G-03A2, SRT, "2D mode")
2D/SV(Teich)	(F-32120, SRT, "Stroke Volume")	(G-0373, SRT, "Image Mode")=(G-03A2, SRT, "2D mode") (G-C036, SRT, "Measurement Method")=(125209, DCM, "Teichholz")
2D/SI(Teich)	(F-00078, SRT, "Stroke Index")	(G-0373, SRT, "Image Mode")=(G-03A2, SRT, "2D mode") (G-C036, SRT, "Measurement Method")=(125209, DCM, "Teichholz")
2D/CO(Teich)	(F-32100, SRT, "Cardiac Output")	(G-0373, SRT, "Image Mode")=(G-03A2, SRT, "2D mode") (G-C036, SRT, "Measurement Method")=(125209, DCM, "Teichholz")
2D/CI(Teich)	(F-32110, SRT, "Cardiac Index")	(G-0373, SRT, "Image Mode")=(G-03A2, SRT, "2D mode") (G-C036, SRT, "Measurement Method")=(125209, DCM, "Teichholz")
2D/SV(Cube)	(F-32120, SRT, "Stroke Volume")	(G-0373, SRT, "Image Mode")=(G-03A2, SRT, "2D mode") (G-C036, SRT, "Measurement Method")=(125206, DCM, "Cube Method")

2D/SI(Cube)	(F-00078, SRT, "Stroke Index")	(G-0373, SRT, "Image Mode")= (G-03A2, SRT, "2D mode") (G-C036, SRT, "Measurement Method")= (125206, DCM, "Cube Method")
2D/CO(Cube)	(F-32100, SRT, "Cardiac Output")	(G-0373, SRT, "Image Mode")= (G-03A2, SRT, "2D mode") (G-C036, SRT, "Measurement Method")= (125206, DCM, "Cube Method")
2D/CI(Cube)	(F-32110, SRT, "Cardiac Index")	(G-0373, SRT, "Image Mode")= (G-03A2, SRT, "2D mode") (G-C036, SRT, "Measurement Method")= (125206, DCM, "Cube Method")
2D/LVd Mass	(18087-7, LN, "Left Ventricle Mass")	(R-4089A, SRT, "Cardiac Cycle Point")= (F-32010, SRT, "Diastole") (G-0373, SRT, "Image Mode")= (G-03A2, SRT, "2D mode")
2D/LVd Mass Index	(GEU-1005-135, 99GEMS, "LVd Mass Index")	(G-0373, SRT, "Image Mode")= (G-03A2, SRT, "2D mode")
2D/LVs Mass	(18087-7, LN, "Left Ventricle Mass")	(R-4089A, SRT, "Cardiac Cycle Point")= (F-32020, SRT, "Systole") (G-0373, SRT, "Image Mode")= (G-03A2, SRT, "2D mode")
2D/LVs Mass Index	(GEU-1005-137, 99GEMS, "LVs Mass Index")	(G-0373, SRT, "Image Mode")= (G-03A2, SRT, "2D mode")
2D/LVd Mass/ASE	(18087-7, LN, "Left Ventricle Mass")	(R-4089A, SRT, "Cardiac Cycle Point")= (F-32010, SRT, "Diastole") (G-0373, SRT, "Image Mode")= (G-03A2, SRT, "2D mode") (G-C036, SRT, "Measurement Method")= (125221, DCM, "Left Ventricle Mass by M-mode")
2D/LVd Mass Index/ASE	(GEU-1005-136, 99GEMS, "LVd Mass Index/ASE")	(G-0373, SRT, "Image Mode")= (G-03A2, SRT, "2D mode")
2D/LVs Mass/ASE	(18087-7, LN, "Left Ventricle Mass")	(R-4089A, SRT, "Cardiac Cycle Point")= (F-32020, SRT, "Systole") (G-0373, SRT, "Image Mode")= (G-03A2, SRT, "2D mode") (G-C036, SRT, "Measurement Method")= (125221, DCM, "Left Ventricle Mass by M-mode")
2D/LVs Mass Index/ASE	(GEU-1005-138, 99GEMS, "LVs Mass Index/ASE")	(G-0373, SRT, "Image Mode")= (G-03A2, SRT, "2D mode")
2D/LVA diastole	(G-0375, SRT, "Left Ventricular Diastolic Area")	(G-0373, SRT, "Image Mode")= (G-03A2, SRT, "2D mode")
2D/LVA systole	(G-0374, SRT, "Left Ventricular Systolic Area")	(G-0373, SRT, "Image Mode")= (G-03A2, SRT, "2D mode")
2D/SAX/LVA diastole	(G-0375, SRT, "Left Ventricular Diastolic Area")	(G-0373, SRT, "Image Mode")= (G-03A2, SRT, "2D mode") (111031, DCM, "Image View")= (G-0397, SRT, "Parasternal short axis")
2D/SAX/LVA systole	(G-0374, SRT, "Left Ventricular Systolic Area")	(G-0373, SRT, "Image Mode")= (G-03A2, SRT, "2D mode") (111031, DCM, "Image View")= (G-0397, SRT, "Parasternal short axis")
2D/SAX/LVAepi diastole	(59093-5, LN, "Epicardial Area")	(R-4089A, SRT, "Cardiac Cycle Point")= (F-32010, SRT, "Diastole") (G-0373, SRT, "Image Mode")= (G-03A2, SRT, "2D mode") (111031, DCM, "Image View")= (G-0397, SRT, "Parasternal short axis")
2D/SAX/LVAepi systole	(59093-5, LN, "Epicardial Area")	(R-4089A, SRT, "Cardiac Cycle Point")= (F-32020, SRT, "Systole") (G-0373, SRT, "Image Mode")= (G-03A2, SRT, "2D mode") (111031, DCM, "Image View")= (G-0397, SRT, "Parasternal short axis")
2D/SAX/LVAend diastole	(59094-3, LN, "Endocardial Area")	(R-4089A, SRT, "Cardiac Cycle Point")= (F-32010, SRT, "Diastole") (G-0373, SRT, "Image Mode")= (G-03A2, SRT, "2D mode") (111031, DCM, "Image View")= (G-0397, SRT, "Parasternal short axis")
2D/SAX/LVAend systole	(59094-3, LN, "Endocardial Area")	(R-4089A, SRT, "Cardiac Cycle Point")= (F-32020, SRT, "Systole") (G-0373, SRT, "Image Mode")= (G-03A2, SRT, "2D mode") (111031, DCM, "Image View")= (G-0397, SRT, "Parasternal short axis")
2D/LVOT Area	(G-038E, SRT, "Cardiovascular Orifice Area")	(G-0373, SRT, "Image Mode")= (G-03A2, SRT, "2D mode") (G-C0E3, SRT, "Finding Site")= (T-32650, SRT, "Left Ventricular Outflow Tract")

DIR DOC1585895 REV 2

2D/EDV(A-L)	(18026-5, LN, "Left Ventricular End Diastolic Volume")	(G-0373, SRT, "Image Mode")= (G-03A2, SRT, "2D mode") (G-C036, SRT, "Measurement Method")= (125205, DCM, "Area-Length Single Plane")
2D/EDV(MOD)	(18026-5, LN, "Left Ventricular End Diastolic Volume")	(G-0373, SRT, "Image Mode")= (G-03A2, SRT, "2D mode") (G-C036, SRT, "Measurement Method")= (125208, DCM, "Method of Disks, Single Plane")
2D/ESV(A-L)	(18148-7, LN, "Left Ventricular End Systolic Volume")	(G-0373, SRT, "Image Mode")= (G-03A2, SRT, "2D mode") (G-C036, SRT, "Measurement Method")= (125205, DCM, "Area-Length Single Plane")
2D/ESV(MOD)	(18148-7, LN, "Left Ventricular End Systolic Volume")	(G-0373, SRT, "Image Mode")= (G-03A2, SRT, "2D mode") (G-C036, SRT, "Measurement Method")= (125208, DCM, "Method of Disks, Single Plane")
2D/EF(A-L)	(18043-0, LN, "Left Ventricular Ejection Fraction")	(G-0373, SRT, "Image Mode")= (G-03A2, SRT, "2D mode") (G-C036, SRT, "Measurement Method")= (125205, DCM, "Area-Length Single Plane")
2D/SV(A-L)	(F-32120, SRT, "Stroke Volume")	(G-0373, SRT, "Image Mode")= (G-03A2, SRT, "2D mode") (G-C036, SRT, "Measurement Method")= (125205, DCM, "Area-Length Single Plane")
2D/SI(A-L)	(F-00078, SRT, "Stroke Index")	(G-0373, SRT, "Image Mode")= (G-03A2, SRT, "2D mode") (G-C036, SRT, "Measurement Method")= (125205, DCM, "Area-Length Single Plane")
2D/EF(MOD)	(18043-0, LN, "Left Ventricular Ejection Fraction")	(G-0373, SRT, "Image Mode")= (G-03A2, SRT, "2D mode") (G-C036, SRT, "Measurement Method")= (125208, DCM, "Method of Disks, Single Plane")
2D/SV(MOD)	(F-32120, SRT, "Stroke Volume")	(G-0373, SRT, "Image Mode")= (G-03A2, SRT, "2D mode") (G-C036, SRT, "Measurement Method")= (125208, DCM, "Method of Disks, Single Plane")
2D/SI(MOD)	(F-00078, SRT, "Stroke Index")	(G-0373, SRT, "Image Mode")= (G-03A2, SRT, "2D mode") (G-C036, SRT, "Measurement Method")= (125208, DCM, "Method of Disks, Single Plane")
LVLd(A4C)	(18074-5, LN, "Left Ventricular Major Axis Diastolic Dimension, 4-chamber view")	
LVAd(A4C)	(G-0375, SRT, "Left Ventricular Diastolic Area")	(111031, DCM, "Image View")= (G-A19C, SRT, "Apical four chamber")
LVEDV(A-L A4C)	(18026-5, LN, "Left Ventricular End Diastolic Volume")	(111031, DCM, "Image View")= (G-A19C, SRT, "Apical four chamber") (G-C036, SRT, "Measurement Method")= (125205, DCM, "Area-Length Single Plane")
LVEDV(MOD A4C)	(18026-5, LN, "Left Ventricular End Diastolic Volume")	(111031, DCM, "Image View")= (G-A19C, SRT, "Apical four chamber") (G-C036, SRT, "Measurement Method")= (125208, DCM, "Method of Disks, Single Plane")
LVLs(A4C)	(18075-2, LN, "Left Ventricular Major Axis Systolic Dimension, 4-chamber view")	
LVAAs(A4C)	(G-0374, SRT, "Left Ventricular Systolic Area")	(111031, DCM, "Image View")= (G-A19C, SRT, "Apical four chamber")
LVESV(A-L A4C)	(18148-7, LN, "Left Ventricular End Systolic Volume")	(111031, DCM, "Image View")= (G-A19C, SRT, "Apical four chamber") (G-C036, SRT, "Measurement Method")= (125205, DCM, "Area-Length Single Plane")
LVESV(MOD A4C)	(18148-7, LN, "Left Ventricular End Systolic Volume")	(111031, DCM, "Image View")= (G-A19C, SRT, "Apical four chamber") (G-C036, SRT, "Measurement Method")= (125208, DCM, "Method of Disks, Single Plane")

DIR DOC1585895 REV 2

EF(A-L A4C)	(18043-0, LN, "Left Ventricular Ejection Fraction")	(111031, DCM, "Image View")= (G-A19C, SRT, "Apical four chamber") (G-C036, SRT, "Measurement Method")= (125205, DCM, "Area-Length Single Plane")
SV(A-L A4C)	(F-32120, SRT, "Stroke Volume")	(111031, DCM, "Image View")= (G-A19C, SRT, "Apical four chamber") (G-C036, SRT, "Measurement Method")= (125205, DCM, "Area-Length Single Plane")
SI(A-L A4C)	(F-00078, SRT, "Stroke Index")	(111031, DCM, "Image View")= (G-A19C, SRT, "Apical four chamber") (G-C036, SRT, "Measurement Method")= (125205, DCM, "Area-Length Single Plane")
CO(A-L A4C)	(F-32100, SRT, "Cardiac Output")	(111031, DCM, "Image View")= (G-A19C, SRT, "Apical four chamber") (G-C036, SRT, "Measurement Method")= (125205, DCM, "Area-Length Single Plane")
CI(A-L A4C)	(F-32110, SRT, "Cardiac Index")	(111031, DCM, "Image View")= (G-A19C, SRT, "Apical four chamber") (G-C036, SRT, "Measurement Method")= (125205, DCM, "Area-Length Single Plane")
EF(MOD A4C)	(18043-0, LN, "Left Ventricular Ejection Fraction")	(111031, DCM, "Image View")= (G-A19C, SRT, "Apical four chamber") (G-C036, SRT, "Measurement Method")= (125208, DCM, "Method of Disks, Single Plane")
SV(MOD A4C)	(F-32120, SRT, "Stroke Volume")	(111031, DCM, "Image View")= (G-A19C, SRT, "Apical four chamber") (G-C036, SRT, "Measurement Method")= (125208, DCM, "Method of Disks, Single Plane")
SI(MOD A4C)	(F-00078, SRT, "Stroke Index")	(111031, DCM, "Image View")= (G-A19C, SRT, "Apical four chamber") (G-C036, SRT, "Measurement Method")= (125208, DCM, "Method of Disks, Single Plane")
CO(MOD A4C)	(F-32100, SRT, "Cardiac Output")	(111031, DCM, "Image View")= (G-A19C, SRT, "Apical four chamber") (G-C036, SRT, "Measurement Method")= (125208, DCM, "Method of Disks, Single Plane")
CI(MOD A4C)	(F-32110, SRT, "Cardiac Index")	(111031, DCM, "Image View")= (G-A19C, SRT, "Apical four chamber") (G-C036, SRT, "Measurement Method")= (125208, DCM, "Method of Disks, Single Plane")
LVLd(A2C)	(18072-9, LN, "Left Ventricular Major Axis Diastolic Dimension, 2-chamber view")	
LVAAd(A2C)	(G-0375, SRT, "Left Ventricular Diastolic Area")	(111031, DCM, "Image View")= (G-A19B, SRT, "Apical two chamber")
LVEDV(A-L A2C)	(18026-5, LN, "Left Ventricular End Diastolic Volume")	(111031, DCM, "Image View")= (G-A19B, SRT, "Apical two chamber") (G-C036, SRT, "Measurement Method")= (125205, DCM, "Area-Length Single Plane")
LVEDV(MOD A2C)	(18026-5, LN, "Left Ventricular End Diastolic Volume")	(111031, DCM, "Image View")= (G-A19B, SRT, "Apical two chamber") (G-C036, SRT, "Measurement Method")= (125208, DCM, "Method of Disks, Single Plane")
LVLs(A2C)	(18073-7, LN, "Left Ventricular Major Axis Systolic Dimension, 2-chamber view")	
LVAAs(A2C)	(G-0374, SRT, "Left Ventricular Systolic Area")	(111031, DCM, "Image View")= (G-A19B, SRT, "Apical two chamber")

DIR DOC1585895 REV 2

LVESV(A-L A2C)	(18148-7, LN, "Left Ventricular End Systolic Volume")	(111031, DCM, "Image View")= (G-A19B, SRT, "Apical two chamber") (G-C036, SRT, "Measurement Method")= (125205, DCM, "Area-Length Single Plane")
LVESV(MOD A2C)	(18148-7, LN, "Left Ventricular End Systolic Volume")	(111031, DCM, "Image View")= (G-A19B, SRT, "Apical two chamber") (G-C036, SRT, "Measurement Method")= (125208, DCM, "Method of Disks, Single Plane")
EF(A-L A2C)	(18043-0, LN, "Left Ventricular Ejection Fraction")	(111031, DCM, "Image View")= (G-A19B, SRT, "Apical two chamber") (G-C036, SRT, "Measurement Method")= (125205, DCM, "Area-Length Single Plane")
SV(A-L A2C)	(F-32120, SRT, "Stroke Volume")	(111031, DCM, "Image View")= (G-A19B, SRT, "Apical two chamber") (G-C036, SRT, "Measurement Method")= (125205, DCM, "Area-Length Single Plane")
SI(A-L A2C)	(F-00078, SRT, "Stroke Index")	(111031, DCM, "Image View")= (G-A19B, SRT, "Apical two chamber") (G-C036, SRT, "Measurement Method")= (125205, DCM, "Area-Length Single Plane")
CO(A-L A2C)	(F-32100, SRT, "Cardiac Output")	(111031, DCM, "Image View")= (G-A19B, SRT, "Apical two chamber") (G-C036, SRT, "Measurement Method")= (125205, DCM, "Area-Length Single Plane")
CI(A-L A2C)	(F-32110, SRT, "Cardiac Index")	(111031, DCM, "Image View")= (G-A19B, SRT, "Apical two chamber") (G-C036, SRT, "Measurement Method")= (125205, DCM, "Area-Length Single Plane")
EF(MOD A2C)	(18043-0, LN, "Left Ventricular Ejection Fraction")	(111031, DCM, "Image View")= (G-A19B, SRT, "Apical two chamber") (G-C036, SRT, "Measurement Method")= (125208, DCM, "Method of Disks, Single Plane")
SV(MOD A2C)	(F-32120, SRT, "Stroke Volume")	(111031, DCM, "Image View")= (G-A19B, SRT, "Apical two chamber") (G-C036, SRT, "Measurement Method")= (125208, DCM, "Method of Disks, Single Plane")
SI(MOD A2C)	(F-00078, SRT, "Stroke Index")	(111031, DCM, "Image View")= (G-A19B, SRT, "Apical two chamber") (G-C036, SRT, "Measurement Method")= (125208, DCM, "Method of Disks, Single Plane")
CO(MOD A2C)	(F-32100, SRT, "Cardiac Output")	(111031, DCM, "Image View")= (G-A19B, SRT, "Apical two chamber") (G-C036, SRT, "Measurement Method")= (125208, DCM, "Method of Disks, Single Plane")
CI(MOD A2C)	(F-32110, SRT, "Cardiac Index")	(111031, DCM, "Image View")= (G-A19B, SRT, "Apical two chamber") (G-C036, SRT, "Measurement Method")= (125208, DCM, "Method of Disks, Single Plane")
LVLd(LAX)	(GEU-1005-57, 99GEMS, "LVLd(LAX)")	
LVAd(LAX)	(G-0375, SRT, "Left Ventricular Diastolic Area")	(111031, DCM, "Image View")= (G-0395, SRT, "Apical long axis")
LVEDV(A-L LAX)	(18026-5, LN, "Left Ventricular End Diastolic Volume")	(111031, DCM, "Image View")= (G-0395, SRT, "Apical long axis") (G-C036, SRT, "Measurement Method")= (125205, DCM, "Area-Length Single Plane")
LVEDV(MOD LAX)	(18026-5, LN, "Left Ventricular End Diastolic Volume")	(111031, DCM, "Image View")= (G-0395, SRT, "Apical long axis") (G-C036, SRT, "Measurement Method")= (125208, DCM, "Method of Disks, Single Plane")

DIR DOC1585895 REV 2

LVLs(LAX)	(GEU-1005-58, 99GEMS, "LVLs(LAX)")	
LVAAs(LAX)	(G-0374, SRT, "Left Ventricular Systolic Area")	(111031, DCM, "Image View")= (G-0395, SRT, "Apical long axis")
LVESV(A-L LAX)	(18148-7, LN, "Left Ventricular End Systolic Volume")	(111031, DCM, "Image View")= (G-0395, SRT, "Apical long axis") (G-C036, SRT, "Measurement Method")= (125205, DCM, "Area-Length Single Plane")
LVESV(MOD LAX)	(18148-7, LN, "Left Ventricular End Systolic Volume")	(111031, DCM, "Image View")= (G-0395, SRT, "Apical long axis") (G-C036, SRT, "Measurement Method")= (125208, DCM, "Method of Disks, Single Plane")
EF(A-L LAX)	(18043-0, LN, "Left Ventricular Ejection Fraction")	(111031, DCM, "Image View")= (G-0395, SRT, "Apical long axis") (G-C036, SRT, "Measurement Method")= (125205, DCM, "Area-Length Single Plane")
SV(A-L LAX)	(F-32120, SRT, "Stroke Volume")	(111031, DCM, "Image View")= (G-0395, SRT, "Apical long axis") (G-C036, SRT, "Measurement Method")= (125205, DCM, "Area-Length Single Plane")
SI(A-L LAX)	(F-00078, SRT, "Stroke Index")	(111031, DCM, "Image View")= (G-0395, SRT, "Apical long axis") (G-C036, SRT, "Measurement Method")= (125205, DCM, "Area-Length Single Plane")
CO(A-L LAX)	(F-32100, SRT, "Cardiac Output")	(111031, DCM, "Image View")= (G-0395, SRT, "Apical long axis") (G-C036, SRT, "Measurement Method")= (125205, DCM, "Area-Length Single Plane")
CI(A-L LAX)	(F-32110, SRT, "Cardiac Index")	(111031, DCM, "Image View")= (G-0395, SRT, "Apical long axis") (G-C036, SRT, "Measurement Method")= (125205, DCM, "Area-Length Single Plane")
EF(MOD LAX)	(18043-0, LN, "Left Ventricular Ejection Fraction")	(111031, DCM, "Image View")= (G-0395, SRT, "Apical long axis") (G-C036, SRT, "Measurement Method")= (125208, DCM, "Method of Disks, Single Plane")
SV(MOD LAX)	(F-32120, SRT, "Stroke Volume")	(111031, DCM, "Image View")= (G-0395, SRT, "Apical long axis") (G-C036, SRT, "Measurement Method")= (125208, DCM, "Method of Disks, Single Plane")
SI(MOD LAX)	(F-00078, SRT, "Stroke Index")	(111031, DCM, "Image View")= (G-0395, SRT, "Apical long axis") (G-C036, SRT, "Measurement Method")= (125208, DCM, "Method of Disks, Single Plane")
CO(MOD LAX)	(F-32100, SRT, "Cardiac Output")	(111031, DCM, "Image View")= (G-0395, SRT, "Apical long axis") (G-C036, SRT, "Measurement Method")= (125208, DCM, "Method of Disks, Single Plane")
CI(MOD LAX)	(F-32110, SRT, "Cardiac Index")	(111031, DCM, "Image View")= (G-0395, SRT, "Apical long axis") (G-C036, SRT, "Measurement Method")= (125208, DCM, "Method of Disks, Single Plane")
LVEDV(MOD BP)	(18026-5, LN, "Left Ventricular End Diastolic Volume")	(G-C036, SRT, "Measurement Method")= (125207, DCM, "Method of Disks, Biplane")
LVESV(MOD BP)	(18148-7, LN, "Left Ventricular End Systolic Volume")	(G-C036, SRT, "Measurement Method")= (125207, DCM, "Method of Disks, Biplane")
EF(Biplane)	(18043-0, LN, "Left Ventricular Ejection Fraction")	(G-C036, SRT, "Measurement Method")= (125207, DCM, "Method of Disks, Biplane")
SV(Biplane)	(F-32120, SRT, "Stroke Volume")	(G-C036, SRT, "Measurement Method")= (125207, DCM, "Method of Disks, Biplane")
SI(Biplane)	(F-00078, SRT, "Stroke Index")	(G-C036, SRT, "Measurement Method")= (125207, DCM, "Method of Disks, Biplane")
CO(Biplane)	(F-32100, SRT, "Cardiac Output")	(G-C036, SRT, "Measurement Method")= (125207, DCM, "Method of Disks, Biplane")
CI(Biplane)	(F-32110, SRT, "Cardiac Index")	(G-C036, SRT, "Measurement Method")= (125207, DCM, "Method of Disks, Biplane")
LVLd(apical)	(18077-8, LN, "Left Ventricle diastolic major axis")	

DIR DOC1585895 REV 2

LVLs(apical)	(18076-0, LN, "Left Ventricle systolic major axis")	
LVA(sax MV)	(G-0375, SRT, "Left Ventricular Diastolic Area")	(111031, DCM, "Image View")= (G-039A, SRT, "Parasternal short axis at the Mitral Valve level")
LVA(sax MV)	(G-0374, SRT, "Left Ventricular Systolic Area")	(111031, DCM, "Image View")= (G-039A, SRT, "Parasternal short axis at the Mitral Valve level")
LVA(sax PM)	(G-0375, SRT, "Left Ventricular Diastolic Area")	(111031, DCM, "Image View")= (G-039B, SRT, "Parasternal short axis at the Papillary Muscle level")
LVA(sax PM)	(G-0374, SRT, "Left Ventricular Systolic Area")	(111031, DCM, "Image View")= (G-039B, SRT, "Parasternal short axis at the Papillary Muscle level")
LVA(sax epi)	(G-0379, SRT, "Left Ventricle Epicardial Diastolic Area, psax pap view")	(G-0373, SRT, "Image Mode")= (G-03A2, SRT, "2D mode")
LVA(sax epi)	(59093-5, LN, "Epicardial Area")	(R-4089A, SRT, "Cardiac Cycle Point")= (F-32020, SRT, "Systole") (G-0373, SRT, "Image Mode")= (G-03A2, SRT, "2D mode") (111031, DCM, "Image View")= (G-039B, SRT, "Parasternal short axis at the Papillary Muscle level")
LVA(sax)	(G-0375, SRT, "Left Ventricular Diastolic Area")	(111031, DCM, "Image View")= (G-0397, SRT, "Parasternal short axis")
LVA(sax)	(G-0374, SRT, "Left Ventricular Systolic Area")	(111031, DCM, "Image View")= (G-0397, SRT, "Parasternal short axis")
EDV(mod sim)	(18026-5, LN, "Left Ventricular End Diastolic Volume")	(G-C036, SRT, "Measurement Method")= (125227, DCM, "Modified Simpson")
ESV(mod sim)	(18148-7, LN, "Left Ventricular End Systolic Volume")	(G-C036, SRT, "Measurement Method")= (125227, DCM, "Modified Simpson")
EF(mod sim)	(18043-0, LN, "Left Ventricular Ejection Fraction")	(G-C036, SRT, "Measurement Method")= (125227, DCM, "Modified Simpson")
SV(mod sim)	(F-32120, SRT, "Stroke Volume")	(G-C036, SRT, "Measurement Method")= (125227, DCM, "Modified Simpson")
SI(mod sim)	(F-00078, SRT, "Stroke Index")	(G-C036, SRT, "Measurement Method")= (125227, DCM, "Modified Simpson")
CO(mod sim)	(F-32100, SRT, "Cardiac Output")	(G-C036, SRT, "Measurement Method")= (125227, DCM, "Modified Simpson")
CI(mod sim)	(F-32110, SRT, "Cardiac Index")	(G-C036, SRT, "Measurement Method")= (125227, DCM, "Modified Simpson")
EDV(bullet)	(18026-5, LN, "Left Ventricular End Diastolic Volume")	(G-C036, SRT, "Measurement Method")= (125228, DCM, "Bullet Method")
ESV(bullet)	(18148-7, LN, "Left Ventricular End Systolic Volume")	(G-C036, SRT, "Measurement Method")= (125228, DCM, "Bullet Method")
EF(bullet)	(18043-0, LN, "Left Ventricular Ejection Fraction")	(G-C036, SRT, "Measurement Method")= (125228, DCM, "Bullet Method")
SV(bullet)	(F-32120, SRT, "Stroke Volume")	(G-C036, SRT, "Measurement Method")= (125228, DCM, "Bullet Method")
SI(bullet)	(F-00078, SRT, "Stroke Index")	(G-C036, SRT, "Measurement Method")= (125228, DCM, "Bullet Method")
CO(bullet)	(F-32100, SRT, "Cardiac Output")	(G-C036, SRT, "Measurement Method")= (125228, DCM, "Bullet Method")
CI(bullet)	(F-32110, SRT, "Cardiac Index")	(G-C036, SRT, "Measurement Method")= (125228, DCM, "Bullet Method")
EDV(bp el)	(18026-5, LN, "Left Ventricular End Diastolic Volume")	(G-C036, SRT, "Measurement Method")= (125211, DCM, "Biplane Ellipse")
ESV(bp el)	(18148-7, LN, "Left Ventricular End Systolic Volume")	(G-C036, SRT, "Measurement Method")= (125211, DCM, "Biplane Ellipse")
EF(bp el)	(18043-0, LN, "Left Ventricular Ejection Fraction")	(G-C036, SRT, "Measurement Method")= (125211, DCM, "Biplane Ellipse")
SV(bp el)	(F-32120, SRT, "Stroke Volume")	(G-C036, SRT, "Measurement Method")= (125211, DCM, "Biplane Ellipse")

SI(bp el)	(F-00078, SRT, "Stroke Index")	(G-C036, SRT, "Measurement Method")= (125211, DCM, "Biplane Ellipse")
CO(bp el)	(F-32100, SRT, "Cardiac Output")	(G-C036, SRT, "Measurement Method")= (125211, DCM, "Biplane Ellipse")
CI(bp el)	(F-32110, SRT, "Cardiac Index")	(G-C036, SRT, "Measurement Method")= (125211, DCM, "Biplane Ellipse")
LVd Mass(A-L)	(18087-7, LN, "Left Ventricle Mass")	(R-4089A, SRT, "Cardiac Cycle Point")= (F-32010, SRT, "Diastole") (G-C036, SRT, "Measurement Method")= (125205, DCM, "Area-Length Single Plane")
LVs Mass(A-L)	(18087-7, LN, "Left Ventricle Mass")	(R-4089A, SRT, "Cardiac Cycle Point")= (F-32020, SRT, "Systole") (G-C036, SRT, "Measurement Method")= (125205, DCM, "Area-Length Single Plane")
MM/IVSd	(18154-5, LN, "Interventricular Septum Diastolic Thickness")	(G-0373, SRT, "Image Mode")= (G-0394, SRT, "M mode")
MM/IVSs	(18158-6, LN, "Interventricular Septum Systolic Thickness")	(G-0373, SRT, "Image Mode")= (G-0394, SRT, "M mode")
MM/LVIDd	(29436-3, LN, "Left Ventricle Internal End Diastolic Dimension")	(G-0373, SRT, "Image Mode")= (G-0394, SRT, "M mode")
MM/LVIDd Index	(GEU-1005-88, 99GEMS, "LVIDd Index")	(G-0373, SRT, "Image Mode")= (G-0394, SRT, "M mode")
MM/LVIDs	(29438-9, LN, "Left Ventricle Internal Systolic Dimension")	(G-0373, SRT, "Image Mode")= (G-0394, SRT, "M mode")
MM/LVIDs Index	(GEU-1005-89, 99GEMS, "LVIDs Index")	(G-0373, SRT, "Image Mode")= (G-0394, SRT, "M mode")
MM/LVPWd	(18152-9, LN, "Left Ventricle Posterior Wall Diastolic Thickness")	(G-0373, SRT, "Image Mode")= (G-0394, SRT, "M mode")
MM/LVPWs	(18156-0, LN, "Left Ventricle Posterior Wall Systolic Thickness")	(G-0373, SRT, "Image Mode")= (G-0394, SRT, "M mode")
MM/EDV(Teich)	(18026-5, LN, "Left Ventricular End Diastolic Volume")	(G-0373, SRT, "Image Mode")= (G-0394, SRT, "M mode") (G-C036, SRT, "Measurement Method")= (125209, DCM, "Teichholz")
MM/ESV(Teich)	(18148-7, LN, "Left Ventricular End Systolic Volume")	(G-0373, SRT, "Image Mode")= (G-0394, SRT, "M mode") (G-C036, SRT, "Measurement Method")= (125209, DCM, "Teichholz")
MM/EF(Teich)	(18043-0, LN, "Left Ventricular Ejection Fraction")	(G-0373, SRT, "Image Mode")= (G-0394, SRT, "M mode") (G-C036, SRT, "Measurement Method")= (125209, DCM, "Teichholz")
MM/SV(Teich)	(F-32120, SRT, "Stroke Volume")	(G-0373, SRT, "Image Mode")= (G-0394, SRT, "M mode") (G-C036, SRT, "Measurement Method")= (125209, DCM, "Teichholz")
MM/SI(Teich)	(F-00078, SRT, "Stroke Index")	(G-0373, SRT, "Image Mode")= (G-0394, SRT, "M mode") (G-C036, SRT, "Measurement Method")= (125209, DCM, "Teichholz")
MM/CO(Teich)	(F-32100, SRT, "Cardiac Output")	(G-0373, SRT, "Image Mode")= (G-0394, SRT, "M mode") (G-C036, SRT, "Measurement Method")= (125209, DCM, "Teichholz")
MM/CI(Teich)	(F-32110, SRT, "Cardiac Index")	(G-0373, SRT, "Image Mode")= (G-0394, SRT, "M mode") (G-C036, SRT, "Measurement Method")= (125209, DCM, "Teichholz")
MM/EDV(Cube)	(18026-5, LN, "Left Ventricular End Diastolic Volume")	(G-0373, SRT, "Image Mode")= (G-0394, SRT, "M mode") (G-C036, SRT, "Measurement Method")= (125206, DCM, "Cube Method")
MM/ESV(Cube)	(18148-7, LN, "Left Ventricular End Systolic Volume")	(G-0373, SRT, "Image Mode")= (G-0394, SRT, "M mode") (G-C036, SRT, "Measurement Method")= (125206, DCM, "Cube Method")
MM/EF(Cube)	(18043-0, LN, "Left Ventricular Ejection Fraction")	(G-0373, SRT, "Image Mode")= (G-0394, SRT, "M mode") (G-C036, SRT, "Measurement Method")= (125206, DCM, "Cube Method")

MM/SV(Cube)	(F-32120, SRT, "Stroke Volume")	(G-0373, SRT, "Image Mode")= (G-0394, SRT, "M mode") (G-C036, SRT, "Measurement Method")= (125206, DCM, "Cube Method")
MM/SI(Cube)	(F-00078, SRT, "Stroke Index")	(G-0373, SRT, "Image Mode")= (G-0394, SRT, "M mode") (G-C036, SRT, "Measurement Method")= (125206, DCM, "Cube Method")
MM/CO(Cube)	(F-32100, SRT, "Cardiac Output")	(G-0373, SRT, "Image Mode")= (G-0394, SRT, "M mode") (G-C036, SRT, "Measurement Method")= (125206, DCM, "Cube Method")
MM/CI(Cube)	(F-32110, SRT, "Cardiac Index")	(G-0373, SRT, "Image Mode")= (G-0394, SRT, "M mode") (G-C036, SRT, "Measurement Method")= (125206, DCM, "Cube Method")
MM/%FS	(18051-3, LN, "Left Ventricular Fractional Shortening")	(G-0373, SRT, "Image Mode")= (G-0394, SRT, "M mode")
MM/IVSd/LVPWd	(18155-2, LN, "Interventricular Septum to Posterior Wall Thickness Ratio")	(R-4089A, SRT, "Cardiac Cycle Point")= (F-32010, SRT, "Diastole") (G-0373, SRT, "Image Mode")= (G-0394, SRT, "M mode")
MM/%IVS Thck	(18054-7, LN, "Interventricular Septum % Thickening")	(G-0373, SRT, "Image Mode")= (G-0394, SRT, "M mode")
MM/%LVPW Thck	(18053-9, LN, "Left Ventricle Posterior Wall % Thickening")	(G-0373, SRT, "Image Mode")= (G-0394, SRT, "M mode")
MM/LVd Mass	(18087-7, LN, "Left Ventricle Mass")	(R-4089A, SRT, "Cardiac Cycle Point")= (F-32010, SRT, "Diastole") (G-0373, SRT, "Image Mode")= (G-0394, SRT, "M mode")
MM/LVs Mass	(18087-7, LN, "Left Ventricle Mass")	(R-4089A, SRT, "Cardiac Cycle Point")= (F-32020, SRT, "Systole") (G-0373, SRT, "Image Mode")= (G-0394, SRT, "M mode")
MM/LVd Mass Index	(GEU-1005-140, 99GEMS, "LVd Mass Index")	(G-0373, SRT, "Image Mode")= (G-0394, SRT, "M mode")
MM/LVs Mass Index	(GEU-1005-142, 99GEMS, "LVs Mass Index")	(G-0373, SRT, "Image Mode")= (G-0394, SRT, "M mode")
MM/LVd Mass/ASE	(18087-7, LN, "Left Ventricle Mass")	(R-4089A, SRT, "Cardiac Cycle Point")= (F-32010, SRT, "Diastole") (G-0373, SRT, "Image Mode")= (G-0394, SRT, "M mode") (G-C036, SRT, "Measurement Method")= (125221, DCM, "Left Ventricle Mass by M-mode")
MM/LVs Mass/ASE	(18087-7, LN, "Left Ventricle Mass")	(R-4089A, SRT, "Cardiac Cycle Point")= (F-32020, SRT, "Systole") (G-0373, SRT, "Image Mode")= (G-0394, SRT, "M mode") (G-C036, SRT, "Measurement Method")= (125221, DCM, "Left Ventricle Mass by M-mode")
MM/LVd Mass Index/ASE	(GEU-1005-141, 99GEMS, "LVd Mass Index/ASE")	(G-0373, SRT, "Image Mode")= (G-0394, SRT, "M mode")
MM/LVs Mass Index/ASE	(GEU-1005-143, 99GEMS, "LVs Mass Index/ASE")	(G-0373, SRT, "Image Mode")= (G-0394, SRT, "M mode")
MM/HeartRate	(8867-4, LN, "Heart rate")	(G-0373, SRT, "Image Mode")= (G-0394, SRT, "M mode")
MM/LVPEP	(18068-7, LN, "Left Ventricle Pre Ejection Period")	(G-0373, SRT, "Image Mode")= (G-0394, SRT, "M mode")
MM/LVET	(20222-6, LN, "Ejection Time")	(G-0373, SRT, "Image Mode")= (G-0394, SRT, "M mode")
MM/LVPEP/ET Ratio	(59088-5, LN, "Pre-Ejection Period/Ejection Time Ratio")	(G-0373, SRT, "Image Mode")= (G-0394, SRT, "M mode")
MM/Vcf mean	(59117-2, LN, "Mean Velocity of Circumferential Fiber Shortening (Mean VcFv)")	(G-0373, SRT, "Image Mode")= (G-0394, SRT, "M mode")
MM/Vcf mean (corr)	(59118-0, LN, "HR-Corrected Mean Velocity of Circumferential Fiber Shortening")	(G-0373, SRT, "Image Mode")= (G-0394, SRT, "M mode")
IVCT	(G-037E, SRT, "Left Ventricular Isovolumic Contraction Time")	
IVRT	(18071-1, LN, "Left Ventricular Isovolumic Relaxation Time")	
MP/LVOT Diam	(G-038F, SRT, "Cardiovascular Orifice Diameter")	(G-C0E3, SRT, "Finding Site")= (T-32650, SRT, "Left Ventricular Outflow Tract")

DIR DOC1585895 REV 2

MP/LVOT VTI	(20354-7, LN, "Velocity Time Integral")	(G-C0E3, SRT, "Finding Site")=(T-32650, SRT, "Left Ventricular Outflow Tract")
LVOT Vmax	(11726-7, LN, "Peak Velocity")	(G-C0E3, SRT, "Finding Site")=(T-32650, SRT, "Left Ventricular Outflow Tract")
LVOT Vmax P	(11726-7, LN, "Peak Velocity")	(G-C0E3, SRT, "Finding Site")=(T-32650, SRT, "Left Ventricular Outflow Tract")
LVOT maxPG	(20247-3, LN, "Peak Gradient")	(G-C0E3, SRT, "Finding Site")=(T-32650, SRT, "Left Ventricular Outflow Tract")
LVOT Vmean	(20352-1, LN, "Mean Velocity")	(G-C0E3, SRT, "Finding Site")=(T-32650, SRT, "Left Ventricular Outflow Tract")
LVOT meanPG	(20256-4, LN, "Mean Gradient")	(G-C0E3, SRT, "Finding Site")=(T-32650, SRT, "Left Ventricular Outflow Tract")
LVOT VTI	(20354-7, LN, "Velocity Time Integral")	(G-C0E3, SRT, "Finding Site")=(T-32650, SRT, "Left Ventricular Outflow Tract")
LVOT Env.Ti	(GEU-1005-32, 99GEMS, "LVOT Env.Ti")	
LVOT HR	(8867-4, LN, "Heart rate")	
LVOT SV	(F-32120, SRT, "Stroke Volume")	(G-C0E3, SRT, "Finding Site")=(T-32650, SRT, "Left Ventricular Outflow Tract")
LVOT SI	(F-00078, SRT, "Stroke Index")	(G-C0E3, SRT, "Finding Site")=(T-32650, SRT, "Left Ventricular Outflow Tract")
LVOT CO	(F-32100, SRT, "Cardiac Output")	(G-C0E3, SRT, "Finding Site")=(T-32650, SRT, "Left Ventricular Outflow Tract")
LVOT CI	(F-32110, SRT, "Cardiac Index")	(G-C0E3, SRT, "Finding Site")=(T-32650, SRT, "Left Ventricular Outflow Tract")
AVA/LVOT Vmax	(11726-7, LN, "Peak Velocity")	(G-C0E3, SRT, "Finding Site")=(T-32650, SRT, "Left Ventricular Outflow Tract")
AVA/LVOT Vmax P	(11726-7, LN, "Peak Velocity")	(G-C0E3, SRT, "Finding Site")=(T-32650, SRT, "Left Ventricular Outflow Tract")
AVA/LVOT maxPG	(20247-3, LN, "Peak Gradient")	(G-C0E3, SRT, "Finding Site")=(T-32650, SRT, "Left Ventricular Outflow Tract")
AVA/LVOT Vmean	(20352-1, LN, "Mean Velocity")	(G-C0E3, SRT, "Finding Site")=(T-32650, SRT, "Left Ventricular Outflow Tract")
AVA/LVOT meanPG	(20256-4, LN, "Mean Gradient")	(G-C0E3, SRT, "Finding Site")=(T-32650, SRT, "Left Ventricular Outflow Tract")
AVA/LVOT VTI	(20354-7, LN, "Velocity Time Integral")	(G-C0E3, SRT, "Finding Site")=(T-32650, SRT, "Left Ventricular Outflow Tract")
AVA/LVOT Env.Ti	(GEU-1005-33, 99GEMS, "AVA/LVOT Env.Ti")	
AVA/LVOT HR	(8867-4, LN, "Heart rate")	
AVA/LVOT SV	(F-32120, SRT, "Stroke Volume")	(G-C0E3, SRT, "Finding Site")=(T-32650, SRT, "Left Ventricular Outflow Tract")
AVA/LVOT SI	(F-00078, SRT, "Stroke Index")	(G-C0E3, SRT, "Finding Site")=(T-32650, SRT, "Left Ventricular Outflow Tract")
AVA/LVOT CO	(F-32100, SRT, "Cardiac Output")	(G-C0E3, SRT, "Finding Site")=(T-32650, SRT, "Left Ventricular Outflow Tract")
AVA/LVOT CI	(F-32110, SRT, "Cardiac Index")	(G-C0E3, SRT, "Finding Site")=(T-32650, SRT, "Left Ventricular Outflow Tract")
LVET	(20222-6, LN, "Ejection Time")	
LVPEP	(18068-7, LN, "Left Ventricle Pre Ejection Period")	
LVPEP/ET Ratio	(GEU-1005-130, 99GEMS, "LVPEP/ET Ratio")	
LIMP	(G-037F, SRT, "Left Ventricular Index of Myocardial Performance")	

DIR DOC1585895 REV 2

AP/LVOT Diam	(G-038F, SRT, "Cardiovascular Orifice Diameter")	(G-C0E3, SRT, "Finding Site")=(T-32650, SRT, "Left Ventricular Outflow Tract")
AP/LVOT VTI	(20354-7, LN, "Velocity Time Integral")	(G-C0E3, SRT, "Finding Site")=(T-32650, SRT, "Left Ventricular Outflow Tract")
ECG/R-R interval	(122182, DCM, "R-R interval")	
ECG/HeartRate	(8867-4, LN, "Heart rate")	
IMP/LVOT	(GEU-1005-147, 99GEMS, "IMP/LVOT")	(G-0373, SRT, "Image Mode")=(R-409E4, SRT, "Doppler Pulsed")

16.2.8 Mitral Valve

TABLE 16-21 MITRAL VALVE

Name of GEU parameter	Base Measurement Concept Name	Concept or Acquisition Context Modifier
MM/MV lft sep	(59109-9, LN, "Leaflet Separation")	
MM/MV D-E Slope	(59127-1, LN, "D-E Slope")	
MV Eann Velocity	(18037-2, LN, "Mitral Valve E-Wave Peak Velocity")	(G-C0E3, SRT, "Finding Site")=(T-35313, SRT, "Mitral Annulus")
MR Acc Slope	(20269-7, LN, "Mitral Valve Acceleration Slope")	(G-C048, SRT, "Direction of Flow")=(R-42E61, SRT, "Regurgitant Flow")
MR dp/dt	(18035-6, LN, "Mitral Regurgitation dP/dt derived from Mitral Regurgitation velocity")	
MVET	(20222-6, LN, "Ejection Time")	
PISA/MR/RF	(G-0390, SRT, "Regurgitant Fraction")	(G-C036, SRT, "Measurement Method")=(125216, DCM, "Proximal Isovelocity Surface Area")
CFM/MR Signal Area	(G-038E, SRT, "Cardiovascular Orifice Area")	(G-C048, SRT, "Direction of Flow")=(R-42E61, SRT, "Regurgitant Flow") (G-0373, SRT, "Image Mode")=(R-409E2, SRT, "Doppler Color Flow")
2D/MV Annulus Diam	(G-038F, SRT, "Cardiovascular Orifice Diameter")	(G-C048, SRT, "Direction of Flow")=(R-42047, SRT, "Antegrade Flow") (G-0373, SRT, "Image Mode")=(G-03A2, SRT, "2D mode") (G-C0E3, SRT, "Finding Site")=(T-35313, SRT, "Mitral Annulus")
2D/EPSS	(18036-4, LN, "Mitral Valve EPSS, E wave")	(G-0373, SRT, "Image Mode")=(G-03A2, SRT, "2D mode")
2D/MVL Thck	(59110-7, LN, "Leaflet Thickness")	(G-0373, SRT, "Image Mode")=(G-03A2, SRT, "2D mode")
2D/SAX/MVA	(G-038E, SRT, "Cardiovascular Orifice Area")	(G-C048, SRT, "Direction of Flow")=(R-42047, SRT, "Antegrade Flow") (G-0373, SRT, "Image Mode")=(G-03A2, SRT, "2D mode") (111031, DCM, "Image View")=(G-0397, SRT, "Parasternal short axis")
2D/MVA Planimetry	(G-038E, SRT, "Cardiovascular Orifice Area")	(G-C048, SRT, "Direction of Flow")=(R-42047, SRT, "Antegrade Flow") (G-0373, SRT, "Image Mode")=(G-03A2, SRT, "2D mode") (G-C036, SRT, "Measurement Method")=(125220, DCM, "Planimetry")
2D/MV Area	(G-038E, SRT, "Cardiovascular Orifice Area")	(G-C048, SRT, "Direction of Flow")=(R-42047, SRT, "Antegrade Flow") (G-0373, SRT, "Image Mode")=(G-03A2, SRT, "2D mode")
MM/EPSS	(18036-4, LN, "Mitral Valve EPSS, E wave")	(G-0373, SRT, "Image Mode")=(G-0394, SRT, "M mode")
MM/MV D-E Excursion	(17997-8, LN, "Mitral Valve D-E Excursion")	(G-0373, SRT, "Image Mode")=(G-0394, SRT, "M mode")
MM/MV E-F Slope	(18040-6, LN, "Mitral Valve E-F Slope by M-Mode")	
MM/MV CE Dist	(59122-2, LN, "C-E Distance")	(G-0373, SRT, "Image Mode")=(G-0394, SRT, "M mode")
MM/MV E/A Ratio	(18038-0, LN, "Mitral Valve E to A Ratio")	(G-0373, SRT, "Image Mode")=(G-0394, SRT, "M mode")

DIR DOC1585895 REV 2

MV Acc Time	(20168-1, LN, "Acceleration Time")	(G-C048, SRT, "Direction of Flow")= (R-42047, SRT, "Antegrade Flow")
MV Acc Slope	(20269-7, LN, "Mitral Valve Acceleration Slope")	
MV A Dur	(G-0385, SRT, "Mitral Valve A-Wave Duration")	
MV E Velocity	(18037-2, LN, "Mitral Valve E-Wave Peak Velocity")	
MV E VTI	(GEU-1005-165, 99GEMS, "MV E VTI")	(R-4089A, SRT, "Cardiac Cycle Point")= (R-40B1B, SRT, "Early Diastole")
MV E Env.Ti	(GEU-1005-160, 99GEMS, "MV E Env.Ti")	
MV A Velocity	(17978-8, LN, "Mitral Valve A-Wave Peak Velocity")	
MV A VTI	(GEU-1005-164, 99GEMS, "MV A VTI")	(R-4089A, SRT, "Cardiac Cycle Point")= (F-32030, SRT, "Atrial Systole")
MV A Env.Ti	(GEU-1005-159, 99GEMS, "MV A Env.Ti")	
MV Dec Time	(20217-6, LN, "Deceleration Time")	(G-C048, SRT, "Direction of Flow")= (R-42047, SRT, "Antegrade Flow")
MV PHT	(20280-4, LN, "Pressure Half-Time")	(G-C048, SRT, "Direction of Flow")= (R-42047, SRT, "Antegrade Flow")
MV Dec Slope	(20216-8, LN, "Deceleration Slope")	(G-C048, SRT, "Direction of Flow")= (R-42047, SRT, "Antegrade Flow")
MVA (PHT)	(G-038E, SRT, "Cardiovascular Orifice Area")	(G-C048, SRT, "Direction of Flow")= (R-42047, SRT, "Antegrade Flow") (G-C036, SRT, "Measurement Method")= (125210, DCM, "Area by Pressure Half-Time")
MVA (VTI)	(G-038E, SRT, "Cardiovascular Orifice Area")	(G-C048, SRT, "Direction of Flow")= (R-42047, SRT, "Antegrade Flow") (G-C036, SRT, "Measurement Method")= (125215, DCM, "Continuity Equation by Velocity Time Integral")
MV meanPG	(20256-4, LN, "Mean Gradient")	(G-C048, SRT, "Direction of Flow")= (R-42047, SRT, "Antegrade Flow")
MV Vmax	(11726-7, LN, "Peak Velocity")	(G-C048, SRT, "Direction of Flow")= (R-42047, SRT, "Antegrade Flow")
MV Vmean	(20352-1, LN, "Mean Velocity")	(G-C048, SRT, "Direction of Flow")= (R-42047, SRT, "Antegrade Flow")
MV maxPG	(20247-3, LN, "Peak Gradient")	(G-C048, SRT, "Direction of Flow")= (R-42047, SRT, "Antegrade Flow")
MV Env.Ti	(GEU-1005-157, 99GEMS, "MV Env.Ti")	
MV VTI	(GEU-1005-162, 99GEMS, "MV VTI")	(G-C048, SRT, "Direction of Flow")= (R-42047, SRT, "Antegrade Flow")
MV HR	(8867-4, LN, "Heart rate")	
MV SV	(F-32120, SRT, "Stroke Volume")	
MV SI	(F-00078, SRT, "Stroke Index")	
MV CO	(F-32100, SRT, "Cardiac Output")	
MV CI	(F-32110, SRT, "Cardiac Index")	
MV E/A Ratio	(18038-0, LN, "Mitral Valve E to A Ratio")	
MV E/A Ratio/Calc	(18038-0, LN, "Mitral Valve E to A Ratio")	
MV Acc Time/MV Dec Time	(G-0386, SRT, "Mitral Valve AT/DT Ratio")	
MV dp/dt	(59120-6, LN, "dP/dt by US")	
MV Time To Peak	(59121-4, LN, "Time to Peak by US")	

DIR DOC1585895 REV 2

MR Vmax	(11726-7, LN, "Peak Velocity")	(G-C048, SRT, "Direction of Flow")= (R-42E61, SRT, "Regurgitant Flow")
MR meanPG	(20256-4, LN, "Mean Gradient")	(G-C048, SRT, "Direction of Flow")= (R-42E61, SRT, "Regurgitant Flow")
MR Vmean	(20352-1, LN, "Mean Velocity")	(G-C048, SRT, "Direction of Flow")= (R-42E61, SRT, "Regurgitant Flow")
MR maxPG	(20247-3, LN, "Peak Gradient")	(G-C048, SRT, "Direction of Flow")= (R-42E61, SRT, "Regurgitant Flow")
MR Env.Ti	(GEU-1005-158, 99GEMS, "MR Env.Ti")	
MR VTI	(GEU-1005-161, 99GEMS, "MR VTI")	(G-C048, SRT, "Direction of Flow")= (R-42E61, SRT, "Regurgitant Flow")
MP VTI	(GEU-1005-163, 99GEMS, "MP VTI")	
MP Area	(GEU-1005-132, 99GEMS, "MP Area")	
MCO	(G-0387, SRT, "Mitral Valve Closure to Opening Time")	
PISA/MR/Flow	(34141-2, LN, "Peak Instantaneous Flow Rate")	(G-C048, SRT, "Direction of Flow")= (R-42E61, SRT, "Regurgitant Flow") (G-C036, SRT, "Measurement Method")= (125216, DCM, "Proximal Isovelocity Surface Area")
PISA/MR/Radius	(GEU-1005-36, 99GEMS, "PISA/MR/Radius")	
PISA/MR/Velocity	(GEU-1005-37, 99GEMS, "PISA/MR/Velocity")	
PISA/MR/Vmax	(11726-7, LN, "Peak Velocity")	(G-C048, SRT, "Direction of Flow")= (R-42E61, SRT, "Regurgitant Flow") (G-C036, SRT, "Measurement Method")= (125216, DCM, "Proximal Isovelocity Surface Area")
PISA/MR/VTI	(20354-7, LN, "Velocity Time Integral")	(G-C048, SRT, "Direction of Flow")= (R-42E61, SRT, "Regurgitant Flow") (G-C036, SRT, "Measurement Method")= (125216, DCM, "Proximal Isovelocity Surface Area")
PISA/MR/ERO	(G-038E, SRT, "Cardiovascular Orifice Area")	(G-C048, SRT, "Direction of Flow")= (R-42E61, SRT, "Regurgitant Flow") (G-C036, SRT, "Measurement Method")= (125216, DCM, "Proximal Isovelocity Surface Area")
PISA/MR/RV	(33878-0, LN, "Volume Flow")	(G-C048, SRT, "Direction of Flow")= (R-42E61, SRT, "Regurgitant Flow") (G-C036, SRT, "Measurement Method")= (125216, DCM, "Proximal Isovelocity Surface Area")
MV Eprime Velocity	(59133-9, LN, "Peak Tissue Velocity")	(R-4089A, SRT, "Cardiac Cycle Point")= (R-40B1B, SRT, "Early Diastole") (G-0373, SRT, "Image Mode")= (R-409E4, SRT, "Doppler Pulsed") (G-C0E3, SRT, "Finding Site")= (T-35313, SRT, "Mitral Annulus")
MV E/Eprime Ratio/Calc	(59111-5, LN, "E Velocity to Annulus E Velocity Ratio")	(G-0373, SRT, "Image Mode")= (R-409E4, SRT, "Doppler Pulsed")
MV Aprime Velocity	(GEU-1005-133, 99GEMS, "MV Aprime Velocity")	(G-0373, SRT, "Image Mode")= (R-409E4, SRT, "Doppler Pulsed")
IMP/MCO	(G-0387, SRT, "Mitral Valve Closure to Opening Time")	(G-0373, SRT, "Image Mode")= (R-409E4, SRT, "Doppler Pulsed")

16.2.9 Pulmonary Artery

TABLE 16-22 PULMONARY ARTERY

Name of GEU parameter	Base Measurement Concept Name	Concept or Acquisition Context Modifier
PA Vmax	(11726-7, LN, "Peak Systolic Velocity")	

DIR DOC1585895 REV 2

PA maxPG	(20247-3, LN, "Peak Gradient")	
2D/MPA	(18020-8, LN, "Main Pulmonary Artery Diameter")	(G-0373, SRT, "Image Mode")= (G-03A2, SRT, "2D mode")
2D/RPA	(18021-6, LN, "Right Pulmonary Artery Diameter")	(G-0373, SRT, "Image Mode")= (G-03A2, SRT, "2D mode")
2D/LPA	(18019-0, LN, "Left Pulmonary Artery Diameter")	(G-0373, SRT, "Image Mode")= (G-03A2, SRT, "2D mode")
2D/LAX/RPA area	(GEU-1005-73, 99GEMS, "LAX/RPA area")	(G-0373, SRT, "Image Mode")= (G-03A2, SRT, "2D mode")
2D/LAX/LPA area	(GEU-1005-74, 99GEMS, "LAX/LPA area")	(G-0373, SRT, "Image Mode")= (G-03A2, SRT, "2D mode")
2D/SAX/RPA area	(GEU-1005-76, 99GEMS, "SAX/RPA area")	(G-0373, SRT, "Image Mode")= (G-03A2, SRT, "2D mode")
2D/SAX/LPA area	(GEU-1005-75, 99GEMS, "SAX/LPA area")	(G-0373, SRT, "Image Mode")= (G-03A2, SRT, "2D mode")
RPA Vmax	(11726-7, LN, "Peak Velocity")	(G-C0E3, SRT, "Finding Site")= (T-44200, SRT, "Right Pulmonary Artery")
RPA maxPG	(20247-3, LN, "Peak Gradient")	(G-C0E3, SRT, "Finding Site")= (T-44200, SRT, "Right Pulmonary Artery")
LPA Vmax	(GEU-106-0014, 99GEMS, "Left Pulmonary Artery Peak Velocity")	(G-C0E3, SRT, "Finding Site")= (T-44000, SRT, " Pulmonary Artery")
LPA maxPG	(GEU-106-0015, 99GEMS, "Left Pulmonary Artery Peak Gradient")	(G-C0E3, SRT, "Finding Site")= (T-44000, SRT, " Pulmonary Artery")
MPA Vmax	(G-038A, SRT, "Main Pulmonary Artery Peak Velocity")	(G-C0E3, SRT, "Finding Site")= (T-44000, SRT, " Pulmonary Artery")
MPA maxPG	(20247-3, LN, "Peak Gradient")	(G-C0E3, SRT, "Finding Site")= (T-44000, SRT, " Pulmonary Artery")
PAEDP	(GEU-1005-42, 99GEMS, "PAEDP")	

16.2.10 Pericardial cavity

TABLE 16-23 PERICARDIAL CAVITY

Name of GEU parameter	Base Measurement Concept Name	Concept or Acquisition Context Modifier
2D/PEs	(121206, DCM, "Distance")	(R-4089A, SRT, "Cardiac Cycle Point")= (F-32020, SRT, "Systole") (G-0373, SRT, "Image Mode")= (G-03A2, SRT, "2D mode") (G-C0E3, SRT, "Finding Site")= (D3-90008, SRT, "Pericardial effusion")
2D/PEd	(121206, DCM, "Distance")	(R-4089A, SRT, "Cardiac Cycle Point")= (F-32010, SRT, "Diastole") (G-0373, SRT, "Image Mode")= (G-03A2, SRT, "2D mode") (G-C0E3, SRT, "Finding Site")= (D3-90008, SRT, "Pericardial effusion")
MM/PEd	(121206, DCM, "Distance")	(R-4089A, SRT, "Cardiac Cycle Point")= (F-32010, SRT, "Diastole") (G-0373, SRT, "Image Mode")= (G-0394, SRT, "M mode") (G-C0E3, SRT, "Finding Site")= (D3-90008, SRT, "Pericardial effusion")

16.2.11 Pulmonic Valve

TABLE 16-24 PULMONIC VALVE

Name of GEU parameter	Base Measurement Concept Name	Concept or Acquisition Context Modifier
CFM/PR Signal Area	(G-038E, SRT, "Cardiovascular Orifice Area")	(G-C048, SRT, "Direction of Flow")= (R-42E61, SRT, "Regurgitant Flow") (G-0373, SRT, "Image Mode")= (R-409E2, SRT, "Doppler Color Flow")
2D/PV Annulus Diam	(G-038F, SRT, "Cardiovascular Orifice Diameter")	(G-C048, SRT, "Direction of Flow")= (R-42047, SRT, "Antegrade Flow") (G-0373, SRT, "Image Mode")= (G-03A2, SRT, "2D mode")

DIR DOC1585895 REV 2

2D/PV Area	(G-038E, SRT, "Cardiovascular Orifice Area")	(G-C048, SRT, "Direction of Flow")= (R-42047, SRT, "Antegrade Flow") (G-0373, SRT, "Image Mode")= (G-03A2, SRT, "2D mode")
MM/Q-to-PV close	(20295-2, LN, "Time from Q wave to Pulmonic Valve Closes")	(G-0373, SRT, "Image Mode")= (G-0394, SRT, "M mode")
PV Vmax	(11726-7, LN, "Peak Velocity")	(G-C048, SRT, "Direction of Flow")= (R-42047, SRT, "Antegrade Flow")
PV Vmax P	(11726-7, LN, "Peak Velocity")	(G-C048, SRT, "Direction of Flow")= (R-42047, SRT, "Antegrade Flow")
PV maxPG	(20247-3, LN, "Peak Gradient")	(G-C048, SRT, "Direction of Flow")= (R-42047, SRT, "Antegrade Flow")
PV Vmean	(20352-1, LN, "Mean Velocity")	(G-C048, SRT, "Direction of Flow")= (R-42047, SRT, "Antegrade Flow")
PV meanPG	(20256-4, LN, "Mean Gradient")	(G-C048, SRT, "Direction of Flow")= (R-42047, SRT, "Antegrade Flow")
PV Acc Time	(20168-1, LN, "Acceleration Time")	(G-C048, SRT, "Direction of Flow")= (R-42047, SRT, "Antegrade Flow")
PV VTI	(20354-7, LN, "Velocity Time Integral")	(G-C048, SRT, "Direction of Flow")= (R-42047, SRT, "Antegrade Flow")
PVA (VTI)	(G-038E, SRT, "Cardiovascular Orifice Area")	(G-C048, SRT, "Direction of Flow")= (R-42047, SRT, "Antegrade Flow") (G-C036, SRT, "Measurement Method")= (125215, DCM, "Continuity Equation by Velocity Time Integral")
PVA (Vmax)	(G-038E, SRT, "Cardiovascular Orifice Area")	(G-C048, SRT, "Direction of Flow")= (R-42047, SRT, "Antegrade Flow") (G-C036, SRT, "Measurement Method")= (125214, DCM, "Continuity Equation by Peak Velocity")
PVA (Vmax)P	(G-038E, SRT, "Cardiovascular Orifice Area")	(G-C048, SRT, "Direction of Flow")= (R-42047, SRT, "Antegrade Flow") (G-C036, SRT, "Measurement Method")= (125214, DCM, "Continuity Equation by Peak Velocity")
PV Env.Ti	(GEU-1005-39, 99GEMS, "PV Env.Ti")	
PV HR	(8867-4, LN, "Heart rate")	
PV SV	(GEU-1005-107, 99GEMS, "PV SV")	
PV SI	(GEU-1005-106, 99GEMS, "PV SI")	
PV CO	(GEU-1005-105, 99GEMS, "PV CO")	
PV CI	(GEU-1005-104, 99GEMS, "PV CI")	
PV Acc Slope	(20167-3, LN, "Acceleration Slope")	(G-C048, SRT, "Direction of Flow")= (R-42047, SRT, "Antegrade Flow")
PVET	(18042-2, LN, "Pulmonic Valve Ejection Time")	
SD/Q-to-PV close	(20295-2, LN, "Time from Q wave to Pulmonic Valve Closes")	(G-0373, SRT, "Image Mode")= (R-409E4, SRT, "Doppler Pulsed")
PV Acc Time/ET Ratio	(G-0388, SRT, "Ratio of Pulmonic Valve Acceleration Time to Ejection Time")	
PV dp/dt	(GEU-1005-153, 99GEMS, "PV dp/dt")	
PV Time To Peak	(GEU-1005-38, 99GEMS, "PV Time To Peak")	
PR PHT	(20280-4, LN, "Pressure Half-Time")	(G-C048, SRT, "Direction of Flow")= (R-42E61, SRT, "Regurgitant Flow")
PR Dec Time	(20217-6, LN, "Deceleration Time")	(G-C048, SRT, "Direction of Flow")= (R-42E61, SRT, "Regurgitant Flow")
PR Dec Slope	(20216-8, LN, "Deceleration Slope")	(G-C048, SRT, "Direction of Flow")= (R-42E61, SRT, "Regurgitant Flow")

DIR DOC1585895 REV 2

PR Vmax	(11726-7, LN, "Peak Velocity")	(G-C048, SRT, "Direction of Flow")= (R-42E61, SRT, "Regurgitant Flow")
PR maxPG	(20247-3, LN, "Peak Gradient")	(G-C048, SRT, "Direction of Flow")= (R-42E61, SRT, "Regurgitant Flow")
PR Vmean	(20352-1, LN, "Mean Velocity")	(G-C048, SRT, "Direction of Flow")= (R-42E61, SRT, "Regurgitant Flow")
PR meanPG	(20256-4, LN, "Mean Gradient")	(G-C048, SRT, "Direction of Flow")= (R-42E61, SRT, "Regurgitant Flow")
PR Env.Ti	(59108-1, LN, "Envelope Duration")	
PR VTI	(20354-7, LN, "Velocity Time Integral")	(G-C048, SRT, "Direction of Flow")= (R-42E61, SRT, "Regurgitant Flow")
PRend Vmax	(18026-5, LN, "End Diastolic Velocity")	(G-C048, SRT, "Direction of Flow")= (R-42E61, SRT, "Regurgitant Flow")
PRend maxPG	(20247-3, LN, "Peak Gradient")	(G-C048, SRT, "Direction of Flow")= (R-42E61, SRT, "Regurgitant Flow") (R-4089A, SRT, "Cardiac Cycle Point")= (109022, DCM, "End Diastole")
PR dp/dt	(GEU-1005-154, 99GEMS, "PR dp/dt")	
PV A Dur-MV A Dur	(GEU-1005-124, 99GEMS, "PV A Dur-MV A Dur")	
PV A Dur/MV VTI	(GEU-1005-122, 99GEMS, "PV A Dur/MV VTI")	
PV A Dur/MV A Dur	(GEU-1005-123, 99GEMS, "PV A Dur/MV A Dur")	
PISA/PR/Flow	(34141-2, LN, "Peak Instantaneous Flow Rate")	(G-C048, SRT, "Direction of Flow")= (R-42E61, SRT, "Regurgitant Flow") (G-C036, SRT, "Measurement Method")= (125216, DCM, "Proximal Isovelocity Surface Area")
PISA/PR/Vmax	(11726-7, LN, "Peak Velocity")	(G-C048, SRT, "Direction of Flow")= (R-42E61, SRT, "Regurgitant Flow") (G-C036, SRT, "Measurement Method")= (125216, DCM, "Proximal Isovelocity Surface Area")
PISA/PR/VTI	(20354-7, LN, "Velocity Time Integral")	(G-C048, SRT, "Direction of Flow")= (R-42E61, SRT, "Regurgitant Flow") (G-C036, SRT, "Measurement Method")= (125216, DCM, "Proximal Isovelocity Surface Area")
PISA/PR/ERO	(G-038E, SRT, "Cardiovascular Orifice Area")	(G-C048, SRT, "Direction of Flow")= (R-42E61, SRT, "Regurgitant Flow") (G-C036, SRT, "Measurement Method")= (125216, DCM, "Proximal Isovelocity Surface Area")
PISA/PR/RV	(33878-0, LN, "Volume Flow")	(G-C048, SRT, "Direction of Flow")= (R-42E61, SRT, "Regurgitant Flow") (G-C036, SRT, "Measurement Method")= (125216, DCM, "Proximal Isovelocity Surface Area")
PR HR	(8867-4, LN, "Heart rate")	(G-0373, SRT, "Image Mode")= (R-409E4, SRT, "Doppler Pulsed")

16.2.12 Pulmonary Venous Structure

TABLE 16-25 PULMONARY VENOUS STRUCTURE

Name of GEU parameter	Base Measurement Concept Name	Concept or Acquisition Context Modifier
P_Vein S	(29450-4, LN, "Pulmonary Vein Systolic Peak Velocity")	
P_Vein D	(29451-2, LN, "Pulmonary Vein Diastolic Peak Velocity")	
P_Vein A	(29453-8, LN, "Pulmonary Vein Atrial Contraction Reversal Peak Velocity")	

DIR DOC1585895 REV 2

P_Vein A Dur	(G-038B, SRT, "Pulmonary Vein A-Wave Duration")	
P_Vein S/D Ratio	(29452-0, LN, "Pulmonary Vein Systolic to Diastolic Ratio")	
P_Vein S VTI	(G-038C, SRT, "Pulmonary Vein S-Wave VTI")	
P_Vein S Env.Ti	(59108-1, LN, "Envelope Duration")	(R-4089A, SRT, "Cardiac Cycle Point")= (F-32020, SRT, "Systole")
P_Vein D VTI	(G-038D, SRT, "Pulmonary Vein D-Wave VTI")	
P_Vein D Env.Ti	(59108-1, LN, "Envelope Duration")	(R-4089A, SRT, "Cardiac Cycle Point")= (F-32010, SRT, "Diastole")

16.2.13 Right Atrium

TABLE 16-26 RIGHT ATRIUM

Name of GEU parameter	Base Measurement Concept Name	Concept or Acquisition Context Modifier
2D/RA	(M-02550, SRT, "Diameter")	(G-0373, SRT, "Image Mode")= (G-03A2, SRT, "2D mode")
2D/RAD Major	(G-A193, SRT, "Major Axis")	(G-0373, SRT, "Image Mode")= (G-03A2, SRT, "2D mode")
2D/RAD Minor	(G-A194, SRT, "Minor Axis")	(G-0373, SRT, "Image Mode")= (G-03A2, SRT, "2D mode")
2D/RAA diastole	(GEU-1005-70, 99GEMS, "RAA diastole")	(G-0373, SRT, "Image Mode")= (G-03A2, SRT, "2D mode")
2D/RAA systole	(17988-7, LN, "Right Atrium Systolic Area")	(G-0373, SRT, "Image Mode")= (G-03A2, SRT, "2D mode")
2D/RA Area	(GEU-1005-134", 99GEMS, "RA Area")	(G-0373, SRT, "Image Mode")= (G-03A2, SRT, "2D mode")
RALd(A4C)	(29466-0, LN, "Right Atrium Superior-Inferior Dimension, 4-chamber view")	(R-4089A, SRT, "Cardiac Cycle Point")= (F-32010, SRT, "Diastole")
RAAd(A4C)	(GEU-1005-64, 99GEMS, "RAAd(A4C)")	
RAEDV(A-L A4C)	(GEU-1005-65, 99GEMS, "RAEDV(A-L A4C)")	
RAEDV(MOD A4C)	(GEU-1005-66, 99GEMS, "RAEDV(MOD A4C)")	
RALs(A4C)	(29466-0, LN, "Right Atrium Superior-Inferior Dimension, 4-chamber view")	(R-4089A, SRT, "Cardiac Cycle Point")= (F-32020, SRT, "Systole")
RAAs(A4C)	(17988-7, LN, "Right Atrium Systolic Area")	
RAESV(A-L A4C)	(GEU-1005-67, 99GEMS, "RAESV(A-L A4C)")	
RAESV(MOD A4C)	(GEU-1005-68, 99GEMS, "RAESV(MOD A4C)")	
RAP	(18070-3, LN, "Right Atrium Systolic Pressure")	

16.2.14 Right Ventricle

TABLE 16-27 RIGHT VENTRICLE

Name of GEU parameter	Base Measurement Concept Name	Concept or Acquisition Context Modifier
MM/RVOT	(G-038F, SRT, "Cardiovascular Orifice Diameter")	(G-0373, SRT, "Image Mode")= (G-0394, SRT, "M mode") (G-C0E3, SRT, "Finding Site")= (G-039D, SRT, "Right Ventricular Outflow Tract")
2D/RVOT Diam	(G-038F, SRT, "Cardiovascular Orifice Diameter")	(G-0373, SRT, "Image Mode")= (G-03A2, SRT, "2D mode") (G-C0E3, SRT, "Finding Site")= (G-039D, SRT, "Right Ventricular Outflow Tract")
2D/RVAWd	(18153-7, LN, "Right Ventricular Anterior Wall Diastolic Thickness")	(G-0373, SRT, "Image Mode")= (G-03A2, SRT, "2D mode")
2D/RVAWs	(18157-8, LN, "Right Ventricular Anterior Wall Systolic Thickness")	(G-0373, SRT, "Image Mode")= (G-03A2, SRT, "2D mode")

DIR DOC1585895 REV 2

2D/RVIDd	(20304-2, LN, "Right Ventricular Internal Diastolic Dimension")	
2D/RVIDs	(20305-9, LN, "Right Ventricular Internal Systolic Dimension")	(G-0373, SRT, "Image Mode")= (G-03A2, SRT, "2D mode")
2D/RVD Major	(G-A193, SRT, "Major Axis")	(G-0373, SRT, "Image Mode")= (G-03A2, SRT, "2D mode")
2D/RVD Minor	(G-A194, SRT, "Minor Axis")	(G-0373, SRT, "Image Mode")= (G-03A2, SRT, "2D mode")
2D/RVA diastole	(GEU-1005-71, 99GEMS, "RVA diastole")	(G-0373, SRT, "Image Mode")= (G-03A2, SRT, "2D mode")
2D/RVA systole	(GEU-1005-72, 99GEMS, "RVA systole")	(G-0373, SRT, "Image Mode")= (G-03A2, SRT, "2D mode")
2D/RVOT Area	(G-038E, SRT, "Cardiovascular Orifice Area")	(G-0373, SRT, "Image Mode")= (G-03A2, SRT, "2D mode") (G-C0E3, SRT, "Finding Site")= (G-039D, SRT, "Right Ventricular Outflow Tract")
RVLd(A4C)	(18078-6, LN, "Right Ventricular Major Axis Diastolic Dimension, 4-chamber view")	(111031, DCM, "Image View")= (G-A19C, SRT, "Apical four chamber")
RVAd(A4C)	(G-A166, SRT, "Area")	(R-4089A, SRT, "Cardiac Cycle Point")= (F-32010, SRT, "Diastole") (111031, DCM, "Image View")= (G-A19C, SRT, "Apical four chamber")
RVEDV(A-L A4C)	(8822-3, LN, "Right Ventricular ED Volume")	(111031, DCM, "Image View")= (G-A19C, SRT, "Apical four chamber") (G-C036, SRT, "Measurement Method")= (125205, DCM, "Area-Length Single Plane")
RVEDV(MOD A4C)	(8822-3, LN, "Right Ventricular ED Volume")	(111031, DCM, "Image View")= (G-A19C, SRT, "Apical four chamber") (G-C036, SRT, "Measurement Method")= (125208, DCM, "Method of Disks, Single Plane")
RVLs(A4C)	(18079-4, LN, "Right Ventricular Major Axis Systolic Dimension, 4-chamber view")	(111031, DCM, "Image View")= (G-A19C, SRT, "Apical four chamber")
RVAs(A4C)	(G-A166, SRT, "Area")	(R-4089A, SRT, "Cardiac Cycle Point")= (F-32020, SRT, "Systole") (111031, DCM, "Image View")= (G-A19C, SRT, "Apical four chamber")
RVESV(A-L A4C)	(8824-5, LN, "Right Ventricular ES Volume")	(111031, DCM, "Image View")= (G-A19C, SRT, "Apical four chamber") (G-C036, SRT, "Measurement Method")= (125205, DCM, "Area-Length Single Plane")
RVESV(MOD A4C)	(8824-5, LN, "Right Ventricular ES Volume")	(111031, DCM, "Image View")= (G-A19C, SRT, "Apical four chamber") (G-C036, SRT, "Measurement Method")= (125208, DCM, "Method of Disks, Single Plane")
MM/RVIDd	(20304-2, LN, "Right Ventricular Internal Diastolic Dimension")	(G-0373, SRT, "Image Mode")= (G-0394, SRT, "M mode")
MM/RVIDs	(20305-9, LN, "Right Ventricular Internal Systolic Dimension")	(G-0373, SRT, "Image Mode")= (G-0394, SRT, "M mode")
MM/RVIDs	(20305-9, LN, "Right Ventricular Internal Systolic Dimension")	(G-0373, SRT, "Image Mode")= (G-0394, SRT, "M mode")
MM/RVAWd	(18153-7, LN, "Right Ventricular Anterior Wall Diastolic Thickness")	(G-0373, SRT, "Image Mode")= (G-0394, SRT, "M mode")
MM/RVAWs	(18157-8, LN, "Right Ventricular Anterior Wall Systolic Thickness")	(G-0373, SRT, "Image Mode")= (G-0394, SRT, "M mode")
MM/RVPEP	(20301-8, LN, "Right Ventricle Pre Ejection Period")	(G-0373, SRT, "Image Mode")= (G-0394, SRT, "M mode")
MM/RVET	(20222-6, LN, "Ejection Time")	(G-0373, SRT, "Image Mode")= (G-0394, SRT, "M mode")
MM/RVPEP/ET Ratio	(59088-5, LN, "Pre-Ejection Period/Ejection Time Ratio")	(G-0373, SRT, "Image Mode")= (G-0394, SRT, "M mode")
Est RVSP	(G-0380, SRT, "Right Ventricular Peak Systolic Pressure")	

DIR DOC1585895 REV 2

RVOT Vmax	(11726-7, LN, "Peak Velocity")	(G-C0E3, SRT, "Finding Site")= (G-039D, SRT, "Right Ventricular Outflow Tract")
RVOT Vmax P	(11726-7, LN, "Peak Velocity")	(G-C0E3, SRT, "Finding Site")= (G-039D, SRT, "Right Ventricular Outflow Tract")
RVOT maxPG	(20247-3, LN, "Peak Gradient")	(G-C0E3, SRT, "Finding Site")= (G-039D, SRT, "Right Ventricular Outflow Tract")
RVOT Vmean	(20352-1, LN, "Mean Velocity")	(G-C0E3, SRT, "Finding Site")= (G-039D, SRT, "Right Ventricular Outflow Tract")
RVOT meanPG	(20256-4, LN, "Mean Gradient")	(G-C0E3, SRT, "Finding Site")= (G-039D, SRT, "Right Ventricular Outflow Tract")
RVOT VTI	(20354-7, LN, "Velocity Time Integral")	(G-C0E3, SRT, "Finding Site")= (G-039D, SRT, "Right Ventricular Outflow Tract")
RVOT Env.Ti	(59108-1, LN, "Envelope Duration")	
RVOT HR	(8867-4, LN, "Heart rate")	
RVOT SV	(F-32120, SRT, "Stroke Volume")	(G-C0E3, SRT, "Finding Site")= (G-039D, SRT, "Right Ventricular Outflow Tract")
RVOT SI	(F-00078, SRT, "Stroke Index")	(G-C0E3, SRT, "Finding Site")= (G-039D, SRT, "Right Ventricular Outflow Tract")
RVOT CO	(F-32100, SRT, "Cardiac Output")	(G-C0E3, SRT, "Finding Site")= (G-039D, SRT, "Right Ventricular Outflow Tract")
RVOT CI	(F-32110, SRT, "Cardiac Index")	(G-C0E3, SRT, "Finding Site")= (G-039D, SRT, "Right Ventricular Outflow Tract")
RVPEP	(20301-8, LN, "Right Ventricle Pre Ejection Period")	
RVET	(20222-6, LN, "Ejection Time")	
RVPEP/ET Ratio	(GEU-1005-129, 99GEMS, "RVPEP/ET Ratio")	
RIMP	(G-0381, SRT, "Right Ventricular Index of Myocardial Performance")	
IMP/RVOT	(GEU-1005-148, 99GEMS, "IMP/RVOT")	(G-0373, SRT, "Image Mode")= (R-409E4, SRT, "Doppler Pulsed")

16.2.15 Tricuspid Valve

TABLE 16-28 TRICUSPID VALVE

Name of GEU parameter	Base Measurement Concept Name	Concept or Acquisition Context Modifier
CFM/TR Signal Area	(G-038E, SRT, "Cardiovascular Orifice Area")	(G-C048, SRT, "Direction of Flow")= (R-42E61, SRT, "Regurgitant Flow") (G-0373, SRT, "Image Mode")= (R-409E2, SRT, "Doppler Color Flow")
2D/TV Annulus Diam	(G-038F, SRT, "Cardiovascular Orifice Diameter")	(G-C048, SRT, "Direction of Flow")= (R-42047, SRT, "Antegrade Flow") (G-0373, SRT, "Image Mode")= (G-03A2, SRT, "2D mode") (G-C0E3, SRT, "Finding Site")= (T-35111, SRT, "Tricuspid Annulus")
2D/TV Area	(G-038E, SRT, "Cardiovascular Orifice Area")	(G-C048, SRT, "Direction of Flow")= (R-42047, SRT, "Antegrade Flow") (G-0373, SRT, "Image Mode")= (G-03A2, SRT, "2D mode")
MM/Q-to-TV open	(20296-0, LN, "Time from Q wave to Tricuspid Valve Opens")	(G-0373, SRT, "Image Mode")= (G-0394, SRT, "M mode")
TV Acc Time	(20168-1, LN, "Acceleration Time")	(G-C048, SRT, "Direction of Flow")= (R-42047, SRT, "Antegrade Flow")
TV Acc Slope	(20343-0, LN, "Tricuspid Valve Acceleration Slope")	
TV E Velocity	(18031-5, LN, "Tricuspid Valve E Wave Peak Velocity")	

DIR DOC1585895 REV 2

TV A Velocity	(18030-7, LN, "Tricuspid Valve A Wave Peak Velocity")	
TV Dec Time	(20217-6, LN, "Deceleration Time")	(G-C048, SRT, "Direction of Flow")= (R-42047, SRT, "Antegrade Flow")
TV Dec Slope	(20216-8, LN, "Deceleration Slope")	(G-C048, SRT, "Direction of Flow")= (R-42047, SRT, "Antegrade Flow")
TV PHT	(20280-4, LN, "Pressure Half-Time")	(G-C048, SRT, "Direction of Flow")= (R-42047, SRT, "Antegrade Flow")
TVA	(G-038E, SRT, "Cardiovascular Orifice Area")	(G-C048, SRT, "Direction of Flow")= (R-42047, SRT, "Antegrade Flow")
TV meanPG	(20256-4, LN, "Mean Gradient")	(G-C048, SRT, "Direction of Flow")= (R-42047, SRT, "Antegrade Flow")
TV Vmax	(11726-7, LN, "Peak Velocity")	(G-C048, SRT, "Direction of Flow")= (R-42047, SRT, "Antegrade Flow")
TV Vmax P	(11726-7, LN, "Peak Velocity")	(G-C048, SRT, "Direction of Flow")= (R-42047, SRT, "Antegrade Flow")
TV Vmean	(20352-1, LN, "Mean Velocity")	(G-C048, SRT, "Direction of Flow")= (R-42047, SRT, "Antegrade Flow")
TV maxPG	(20247-3, LN, "Peak Gradient")	(G-C048, SRT, "Direction of Flow")= (R-42047, SRT, "Antegrade Flow")
TV VTI	(20354-7, LN, "Velocity Time Integral")	(G-C048, SRT, "Direction of Flow")= (R-42047, SRT, "Antegrade Flow")
TVA (VTI)	(G-038E, SRT, "Cardiovascular Orifice Area")	(G-C048, SRT, "Direction of Flow")= (R-42047, SRT, "Antegrade Flow") (G-C036, SRT, "Measurement Method")= (125215, DCM, "Continuity Equation by Velocity Time Integral")
TVA (Vmax)	(G-038E, SRT, "Cardiovascular Orifice Area")	(G-C048, SRT, "Direction of Flow")= (R-42047, SRT, "Antegrade Flow") (G-C036, SRT, "Measurement Method")= (125214, DCM, "Continuity Equation by Peak Velocity")
TVA (Vmax)P	(G-038E, SRT, "Cardiovascular Orifice Area")	(G-C048, SRT, "Direction of Flow")= (R-42047, SRT, "Antegrade Flow") (G-C036, SRT, "Measurement Method")= (125214, DCM, "Continuity Equation by Peak Velocity")
TV HR	(8867-4, LN, "Heart rate")	
TV E/A Ratio	(18039-8, LN, "Tricuspid Valve E to A Ratio")	
TV Acc Time/TV Dec Time	(GEU-1005-144, 99GEMS, "TV Acc Time/TV Dec Time")	
SD/Q-to-TV open	(20296-0, LN, "Time from Q wave to Tricuspid Valve Opens")	(G-0373, SRT, "Image Mode")= (R-409E4, SRT, "Doppler Pulsed")
TR meanPG	(20256-4, LN, "Mean Gradient")	(G-C048, SRT, "Direction of Flow")= (R-42E61, SRT, "Regurgitant Flow")
TR Vmax	(11726-7, LN, "Peak Velocity")	(G-C048, SRT, "Direction of Flow")= (R-42E61, SRT, "Regurgitant Flow")
TR Vmean	(20352-1, LN, "Mean Velocity")	(G-C048, SRT, "Direction of Flow")= (R-42E61, SRT, "Regurgitant Flow")
TR maxPG	(20247-3, LN, "Peak Gradient")	(G-C048, SRT, "Direction of Flow")= (R-42E61, SRT, "Regurgitant Flow")
TR VTI	(20354-7, LN, "Velocity Time Integral")	(G-C048, SRT, "Direction of Flow")= (R-42E61, SRT, "Regurgitant Flow")
TCO	(G-0389, SRT, "Tricuspid Valve Closure to Opening Time")	
PISA/TR/Flow	(34141-2, LN, "Peak Instantaneous Flow Rate")	(G-C048, SRT, "Direction of Flow")= (R-42E61, SRT, "Regurgitant Flow") (G-C036, SRT, "Measurement Method")= (125216, DCM, "Proximal Isovelocity Surface Area")

DIR DOC1585895 REV 2

PISA/TR/Vmax	(11726-7, LN, "Peak Velocity")	(G-C048, SRT, "Direction of Flow")= (R-42E61, SRT, "Regurgitant Flow") (G-C036, SRT, "Measurement Method")= (125216, DCM, "Proximal Isovelocity Surface Area")
PISA/TR/VTI	(20354-7, LN, "Velocity Time Integral")	(G-C048, SRT, "Direction of Flow")= (R-42E61, SRT, "Regurgitant Flow") (G-C036, SRT, "Measurement Method")= (125216, DCM, "Proximal Isovelocity Surface Area")
PISA/TR/ERO	(G-038E, SRT, "Cardiovascular Orifice Area")	(G-C048, SRT, "Direction of Flow")= (R-42E61, SRT, "Regurgitant Flow") (G-C036, SRT, "Measurement Method")= (125216, DCM, "Proximal Isovelocity Surface Area")
PISA/TR/RV	(33878-0, LN, "Volume Flow")	(G-C048, SRT, "Direction of Flow")= (R-42E61, SRT, "Regurgitant Flow") (G-C036, SRT, "Measurement Method")= (125216, DCM, "Proximal Isovelocity Surface Area")
2D/TVA Planimetry	(G-038E, SRT, "Cardiovascular Orifice Area")	(G-C048, SRT, "Direction of Flow")= (R-42047, SRT, "Antegrade Flow") (G-0373, SRT, "Image Mode")= (G-03A2, SRT, "2D mode") (G-C036, SRT, "Measurement Method")= (125220, DCM, "Planimetry")
TV A Dur	(59105-7, LN, "A-Wave Duration")	(G-0373, SRT, "Image Mode")= (R-409E4, SRT, "Doppler Pulsed")
IMP/TCO	(G-0389, SRT, "Tricuspid Valve Closure to Opening Time")	(G-0373, SRT, "Image Mode")= (R-409E4, SRT, "Doppler Pulsed")

16.2.16 Vena Cava

TABLE 16-29 VENA CAVA

Name of GEU parameter	Base Measurement Concept Name	Concept or Acquisition Context Modifier
2D/IVC Diam Ins	(18006-7, LN, "Inferior Vena Cava Diameter")	(R-40899, SRT, "Respiratory Cycle Point")= (F-20010, SRT, "Inspiration")
2D/IVC Diam Exp	(18006-7, LN, "Inferior Vena Cava Diameter")	(R-40899, SRT, "Respiratory Cycle Point")= (F-20020, SRT, "Expiration")
2D/SVC Diam Ins	(18007-5, LN, "Superior Vena Cava Diameter")	(R-40899, SRT, "Respiratory Cycle Point")= (F-20010, SRT, "Inspiration")
2D/SVC Diam Exp	(18007-5, LN, "Superior Vena Cava Diameter")	(R-40899, SRT, "Respiratory Cycle Point")= (F-20020, SRT, "Expiration")
2D/IVC	(18006-7, LN, "Inferior Vena Cava Diameter")	(G-0373, SRT, "Image Mode")= (G-03A2, SRT, "2D mode")

16.2.17 General Anatomy

TABLE 16-30 GENERAL ANATOMY

Name of GEU parameter	Base Measurement Concept Name	Concept or Acquisition Context Modifier
2D/LCA	(GEU-1005-85, 99GEMS, "LCA")	(G-0373, SRT, "Image Mode")= (G-03A2, SRT, "2D mode")
2D/RCA	(GEU-1005-86, 99GEMS, "RCA")	(G-0373, SRT, "Image Mode")= (G-03A2, SRT, "2D mode")
2D/LCX	(GEU-1005-87, 99GEMS, "LCX")	(G-0373, SRT, "Image Mode")= (G-03A2, SRT, "2D mode")
MM/R-R interval	(122182, DCM, "R-R interval")	(G-0373, SRT, "Image Mode")= (G-0394, SRT, "M mode")
IMP/LIMP	(GEU-1005-145, 99GEMS, "IMP/LIMP")	(G-0373, SRT, "Image Mode")= (R-409E4, SRT, "Doppler Pulsed") Left, Interaction Between Intramyocardial Pressure
IMP/RIMP	(GEU-1005-146, 99GEMS, "IMP/RIMP")	(G-0373, SRT, "Image Mode")= (R-409E4, SRT, "Doppler Pulsed") Right, Interaction Between Intramyocardial Pressure

16.3 OB-GYN ULTRASOUND PROCEDURE REPORT

This section describes the contents of the OB-GYN Ultrasound Procedure Report (TID 5000) SR.

16.3.1 OB-GYN Template Structure

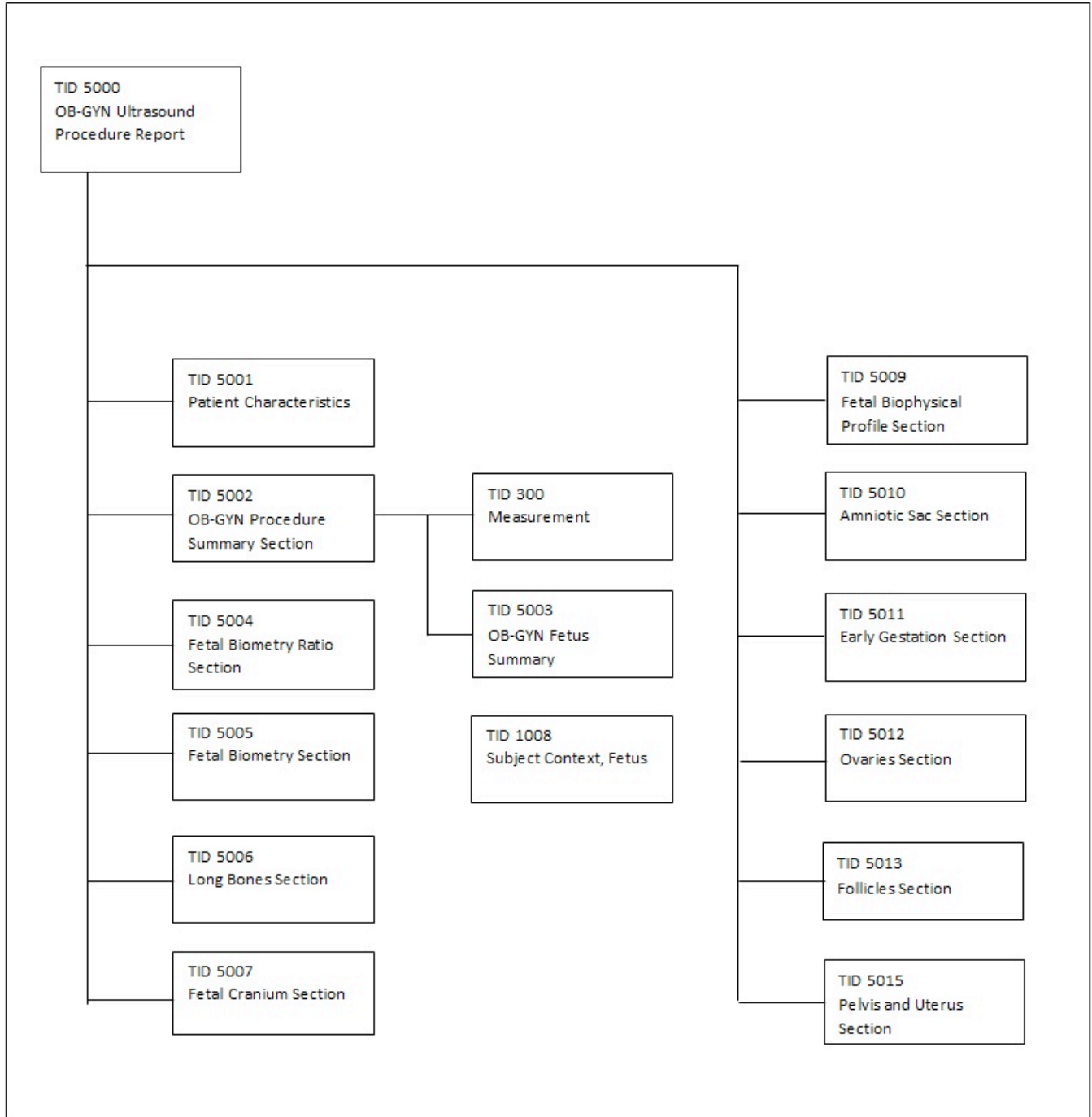

16.3.2 TID 5000 Template

LOGIQ E8 supports the following template TID 5000 for SOP Instances created by this product when exam types selected are OB and GYN.

TABLE 16-31 TID 5000

	N L	Relation with Parent	Value Type	Concept Name	VM	Req Type	Condition	Value Set Constraint
1			CONTAINER	EV (125000, DCM, 'OB-GYN Ultrasound Procedure Report')	1	M		
2	>	HAS OBS CONTEXT	INCLUDE	DTID (1001) Observation Context	1	M		
3	>	CONTAINS	INCLUDE	DTID (5001) Patient Characteristics	1	U		
4	>	CONTAINS	INCLUDE	DTID (5002) OB-GYN Procedure Summary Section	1	U		
5	>	CONTAINS	INCLUDE	DTID (5004) Fetal Biometry Ratio Section	1-n	U		
6	>	CONTAINS	INCLUDE	DTID (5005) Fetal Biometry Section	1-n	U		
7	>	CONTAINS	INCLUDE	DTID (5006) Long Bones Section	1-n	U		
8	>	CONTAINS	INCLUDE	DTID (5007) Fetal Cranium Section	1-n	U		
9	>	CONTAINS	INCLUDE	DTID (5009) Fetal Biophysical Profile Section	1-n	U		
10	>	CONTAINS	INCLUDE	DTID (5011) Early Gestation Section	1-n	U		
11	>	CONTAINS	INCLUDE	DTID (5010) Amniotic Sac Section	1-n	U		
12	>	CONTAINS	INCLUDE	DTID (5015) Pelvis and Uterus Section	1-n	U		
13	>	CONTAINS	INCLUDE	DTID (5012) Ovaries Section	1-n	U		
14	>	CONTAINS	INCLUDE	DTID (5013) Follicles Section	1-n	U		\$Laterality = EV (G-A101, SRT, 'Left') \$Number = EV (11879-4, LN, 'Number of follicles in left ovary')
14	>	CONTAINS	INCLUDE	DTID (5013) Follicles Section	1-n	U		\$Laterality = EV (G-A100, SRT, 'Right') \$Number = EV (11879-4, LN, 'Number of follicles in left ovary')

16.3.3 TID 5001 OB-GYN Patient Characteristics

TABLE 16-32 TID 5001

	NL	Relation with Parent	Value Type	Concept Name	VM	Req Type	Condition / Notes
1			CONTAINER	EV (12118, DCM, 'Patient Characteristics')		M	
2	>	CONTAINS	TEXT	EV (121106, DCM, 'Comment')	1	U	
3	>	CONTAINS	NUM	EV (8302-2, LN, 'Patient Height')	1	U	
4	>	CONTAINS	NUM	EV (11996-6, LN, 'Gravida')	1	U	See GEU SR Mapping Table xvi
5	>	CONTAINS	NUM	EV (11977-6, LN, 'Para')	1	U	See GEU SR

							Mapping Table xvi
6	>	CONTAINS	NUM	EV (11612-9, LN, 'Aborta')	1	U	See GEU SR Mapping Table xvi
7	>	CONTAINS	NUM	EV (33065-4, LN, 'Ectopic Pregnancies')	1	U	See GEU SR Mapping Table xvi

16.3.4 GEU SR Mapping Table for Patient Characteristics:

TABLE 16-33 GEU SR MAPPING TABLE FOR PATIENT CHARACTERISTICS

Name of GEU parameter	Base Measurement Concept Name
Gravida	(11996-6, LN, 'Gravida')
Para	(11977-6, LN, 'Para')
Abortion	(11612-9, LN, 'Aborta')
Ectopic	(33065-4, LN, 'Ectopic Pregnancies')

16.3.5 TID 5002 OB-GYN Procedure Summary Section

TABLE 16-34 TID 5002

	NL	Relation with Parent	Value Type	Concept Name	VM	Req Type	Condition	Value Set Constraint
1			CONTAINER	DT(121111, DCM, 'Summary')	1	M		
2	>	CONTAINS	DATE	DCID (12003) OB-GYN Dates	1-n	U		
3	>	CONTAINS	INCLUDE	DTID (300) Measurement	1-n	U		\$Measurement=BCID (12018) OB-GYN Summary
4	>	CONTAINS	TEXT	EV (121106, DCM, 'Comment')	1-n	U		
5	>	CONTAINS	INCLUDE	BTID (5003) OB-GYN Fetus Summary	1-n	UC	No more than 1 inclusion per fetus	

16.3.6 Usage of TID 5003 OB-GYN Fetus Summary

TABLE 16-35 TID 5003

	NL	Relation with Parent	Value Type	Concept Name	VM	Req Type	Condition	Value Set Constraint
1			CONTAINER	DT (125008, DCM, 'Fetus Summary')	1	M		
2	>	HAS OBS CONTEXT	INCLUDE	DTID (1008) Subject Context, Fetus	1	MC	To describe n fetus, invokes this template n times	

16.3.7 GEU Parameters Map from TID 5009 Fetal Biophysical Profile Section

TABLE 16-36 GEU PARAMETERS MAP FROM TID 5009

Name of GEU parameter	Base Measurement Concept Name
OB/Biophysical/movement	(11631-9, LN, 'Gross Body Movement')
OB/Biophysical/tone	(11635-0, LN, 'Fetal Tone')
OB/Biophysical/breathing	(11632-7, LN, 'Fetal Breathing')
OB/Biophysical/fluid	(11630-1, LN, 'Amniotic Fluid Volume')
OB/Biophysical/reactiveNst	(11635-5, LN, 'Fetal Heart Reactivity')

OB/Biophysical/score	(11634-3, LN, 'Biophysical Profile Sum Score')
----------------------	--

16.3.8 GEU Parameters Map from Context ID 12019 OB-GYN Fetus Summary

TABLE 16-37 CONTEXT ID 12019

Name of GEU parameter	Base Measurement Concept Name
OB/CUA	(11888-5, LN, Composite Ultrasound Age)
EFW(AC,BPD)	(11727-5, LN, 'Estimated Weight')

16.3.9 GEU Parameter Map from Context ID 12011 Ultrasound Pelvis and Uterus

TABLE 16-38 CONTEXT ID 12011

Name of GEU parameter	Base Measurement Concept Name
Gyn/2D/UtL	(11842-2, LN, Uterus Length)
Gyn/2D/UtH	(11859-6, LN, Uterus Height)
Gyn/2D/UtW	(11865-3, LN, Uterus Width)
Gyn/2D/UtVolume	(33192-6, LN, Uterus Volume)
Gyn/2D/Endo	(12145-9, LN, 'Endometrium Thickness')
Ob/2D/OvL with Side=Rt	(11841-4, LN, 'Right Ovary Length')
Ob/2D/OvH with Side=Rt	(11858-8, LN, 'Right Ovary Height')
Ob/2D/OvW with Side=Rt	(11830-7, LN, 'Right Ovary Width')
Ob/2D/OvVolume with Side=Rt	(12165-7, LN, 'Right Ovary Volume')
Ob/2D/OvL with Side=Lt	(11840-6, LN, 'Left Ovary Length')
Ob/2D/OvH with Side=Lt	(11857-0, LN, 'Left Ovary Height')
Ob/2D/OvW with Side=Lt	(11829-9, LN, 'Left Ovary Width')
Ob/2D/OvVolume with Side=Lt	(12164-0, LN, 'Left Ovary Volume')
Gyn/2D/OvFoVolume/Volume	(G-D705, SRT, 'Volume')

16.3.10 GEU Parameter Map from Context ID 12005 Fetal Biometry Measurements

TABLE 16-39 CONTEXT ID 12005

Name of GEU parameter	Base Measurement Concept Name
BPD	(11820-8, LN, 'Biparietal Diameter')
AC	(11979-2, LN, 'Abdominal Circumference')
OFD	(11851-3, LN, 'Occipital-Frontal Diameter')
FL	(11963-6, LN, 'Femur Length')
HC	(11984-2, LN, 'Head Circumference')
TAD	(11862-0, LN, 'Transverse Abdominal Diameter')
TCD	(11863-8, LN, 'Trans Cerebellar Diameter')
TTD	(11864-6, LN, 'Transverse Thoracic Diameter')
Ft	(11965-1, LN, 'Foot length')
FTA	(33068-8, LN, 'Thoracic Area')
APTD	(11819-0, LN, 'Anterior-Posterior Trunk Diameter')

DIR DOC1585895 REV 2

16.3.11 GEU Parameter Map from Context ID 12004 Fetal Biometry Ratios

TABLE 16-40 CONTEXT ID 12004

Name of GEU parameter	Base Measurement Concept Name
Ratio HC/AC	(11947-9, LN, 'HC/AC')
Ratio FL/BPD	(11872-9, LN, 'FL/BPD')
Ratio FL/AC	(11871-1, LN, 'FL/AC')
Ratio FL/HC	(11873-7, LN, 'FL/HC')
CI	(11823-2, LN, 'Cephalic Index')

16.3.12 GEU Parameter Map from Context ID 12006 Fetal Long Bones Measurement

TABLE 16-41 CONTEXT ID 12006

Name of GEU parameter	Base Measurement Concept Name
FL	(11963-6, LN, 'Femur Length')
HL	(11966-9, LN, 'Humerus length')
ULNA	(11969-3, LN, 'Ulna length')
TIB	(11968-5, LN, 'Tibia length')
FIB	(11964-4, LN, 'Fibula length')
Radius	(11967-7, LN, 'Radius length')
CLA	(11962-8, LN, 'Clavicle length')

16.3.13 GEU Parameter Map from Context ID 12013 Gestational Age Equations and Tables

TABLE 16-42 CONTEXT ID 12013

Name of GEU parameter	Base Measurement Concept Name
OB/Campbell/Ratio HC/AC-Min	(33182-7, LN, 'HC/AC by GA, Campbell 1977')
OB/Campbell/Ratio HC/AC-Max	(33182-7, LN, 'HC/AC by GA, Campbell 1977')
OB/Jeanty/BPD-GP	(33153-8, LN, 'BPD by GA, Jeanty 1982')
OB/Jeanty/HC-GP	(33175-1, LN, 'HC by GA, Jeanty 1982')
OB/Jeanty/FL-GP	(33168-6, LN, 'FL by GA, Jeanty 1982')
OB/Hadlock/BPD-GP	(33198-3, LN, 'BPD by GA, Hadlock 1984')
OB/Hadlock/AC-GP	(33146-2, LN, 'AC by GA, Hadlock 1984')
OB/Hadlock/HC-GP	(33173-6, LN, 'HC by GA, Hadlock 1984')
OB/Hadlock/FL-GP	(33166-0, LN, 'FL by GA, Hadlock 1984')
OB/ASUM/BPD-GA	(33079-5, LN, 'BPD, ASUM 1989')
OB/ASUM/CRL-GA	(33089-4, LN, 'CRL, ASUM 1991')
OB/ASUM/AC-GA	(33072-0, LN, 'AC, ASUM 2000')
OB/ASUM2000/BPD-GA	(33151-2, LN, "BPD, ASUM 2000")
Eriksen/TAD-GA	(33128-0, LN, 'TAD, Eriksen 1985')
OB/Goldstein/TCD-GA	(33133-0, LN, 'TCD, Goldstein 1987')
OB/Hohler/FL-GA	(11922-2, LN, 'FL, Hohler 1982')
OB/Jeanty/CRL-GA	(33092-8, LN, 'CRL, Jeanty 1982')
OB/Jeanty/BPD-GA	(33539-8, LN, 'BPD, Jeanty 1982')
OB/Jeanty/AC-GA	(33537-2, LN, 'AC, Jeanty 1982')

OB/Jeanty/HC-GA	(33113-2, LN, 'HC, Jeanty 1982')
OB/Jeanty/FL-GA	(33099-3, LN, 'FL, Jeanty 1982')
OB/Jeanty/ULNA-GA	(11944-6, LN, 'Ulna, Jeanty 1984')
OB/Jeanty/HL-GA	(11936-2, LN, 'Humerus, Jeanty 1984')
OB/Jeanty/TIB-GA	(11941-2, LN, 'Tibia, Jeanty 1984')
OB/Jeanty/FIB-GA	(33097-7, LN, 'Fibula, Jeanty 1983')
OB/Jeanty/Radius-GA	(33126-4, LN, 'Radius, Jeanty 1983')
OB/Merz/BPD-GA	(33081-1, LN, 'BPD, Merz 1988')
OB/Merz/AC-GA	(33075-3, LN, 'AC, Merz 1988')
OB/Merz/HC-GA	(33115-7, LN, 'HC Merz, 1988')
OB/Merz/FL-GA	(33542-2, LN, 'FL, Merz 1988')
OB/Hadlock/BPD-GA	(11902-4, LN, 'BPD, Hadlock 1984')
OB/Hadlock/AC-GA	(11892-7, LN, 'AC, Hadlock 1984')
OB/Hadlock/HC-GA	(11932-1, LN, 'HC, Hadlock 1984')
OB/Hadlock/FL-GA	(11920-6, LN, 'FL, Hadlock 1984')
OB/Hadlock/CRL-GA	(11910-7, LN, 'CRL, Hadlock 1992')
OB/Hansmann/GS-GA	(33105-8, LN, 'GS, Hansmann 1979')
OB/Hansmann/BPD-GA	(11903-2, LN, 'BPD, Hansmann 1985')
OB/Hansmann/CRL-GA	(11911-5, LN, 'CRL, Hansmann 1985')
OB/Hansmann/OFD-GA	(33544-8, LN, 'OFD, Hansmann 1985')
OB/Hansmann/HC-GA	(33112-4, LN, 'HC, Hansmann 1985')
OB/Hansmann/TAD-GA	(33129-8, LN, 'TAD Hansmann, 1979')
OB/Hansmann/ThD-GA	(33136-3, LN, 'Transverse Thoracic Diameter, Hansmann 1985')
OB/Hansmann/FL-GA	(11921-4, LN, 'FL, Hansmann 1985')
OB/Hansmann/AC-GA	(33073-8, LN, 'AC, Hansmann 1985')
OB/Hellman/GS-GA	(11928-9, LN, 'GS, Hellman 1969')
OB/Rempen/GS-GA	(11929-7, LN, 'GS, Rempen 1991')
OB/Rempen/CRL-GA	(33094-4, LN, 'CRL, Rempen 1991')
OB/Rempen/BPD-GA	(33083-7, LN, 'BPD, Rempen 1991')
OB/Hill/TCD-GA	(33134-8, LN, 'TCD, Hill 1990')
OB/Mercer/Ft-GA	(11926-3, LN, 'Foot Length, Mercer 1987')
OB/Kurtz/BPD-GA	(11906-5, LN, 'BPD, Kurtz 1980')
OB/Nelson/CRL-GA	(11913-1, LN, 'CRL, Nelson 1981')
OB/Robinson/CRL-GA	(11914-9, LN, 'CRL, Robinson 1975')
OB/Mayden/OOD-GA	(33124-9, LN, 'OOD, Mayden, 1982')
OB/Mayden/IOD-GA	(33122-3, LN, 'IOD, Mayden 1982')
OB/Yarkoni/CLA-GA	(33088-6, LN, 'Clavical length, Yarkoni 1985')
OB/Osaka/CRL-GA	(33093-6, LN, 'CRL, Osaka 1989')
OB/Osaka/BPD-GA	(33082-9, LN, 'BPD, Osaka 1989')
OB/Osaka/FL-GA	(33101-7, LN, 'FL, Osaka 1989')
OB/Osaka/HL-GA	(33117-3, LN, 'Humerus Length, Osaka 1989')
OB/Tokyo/GS-GA	(33108-2, LN, 'GS, Tokyo 1986')
OB/Tokyo/CRL-GA	(33096-9, LN, 'CRL, Tokyo 1986')
OB/Tokyo/BPD-GA	(33085-2, LN, 'BPD, Tokyo 1986')

OB/Tokyo/FL-GA	(33103-3, LN, 'FL, Tokyo 1986')
OB/Shinozuka/BPD-GA	(33084-5, LN, 'BPD, Shinozuka 1996')
OB/Shinozuka/AC-GA	(33076-1, LN, 'AC, Shinozuka 1996')
OB/Shinozuka/FL-GA	(33102-5, LN, 'FL, Shinozuka 1996')
OB/Shinozuka/CRL-GA	(33095-1, LN, 'CRL, Shinozuka 1996')
average	(11884-4, LN, 'Average Ultrasound Age')

16.3.14 GEU Parameter Map from Context ID 12009 Early Gestation Biometry

TABLE 16-43 CONTEXT ID 12009

Name of GEU parameter	Standard Concept Name
CRL	(11957-8, LN, 'Crown Rump Length')
GS	(11850-5, LN, 'Gestational Sac Diameter')
NT	(33069-6, LN, 'Nuchal Translucency')

16.3.15 GEU Parameter Map from Context ID 12008 OB-GYN Amniotic Sac

TABLE 16-44 CONTEXT ID 12008

Name of GEU parameter	Measurement Concept Name
AFI1	(11624-4, LN, 'First Quadrant Diameter')
AFI2	(11626-9, LN, 'Second Quadrant Diameter')
AFI3	(11625-1, LN, 'Third Quadrant Diameter')
AFI4	(11623-6, LN, 'Fourth Quadrant Diameter')
AFI Sum	(11627-7, LN, 'Amniotic Fluid Index')

16.3.16 GEU Parameters Map to Context ID 226 Population Statistical Descriptors

TABLE 16-45 CONTEXT ID 226

Name of GEU parameter	Base Measurement Concept Name
OB/ASUM/BPD-Min OB/ASUM/AC-Min OB/ASUM2000/BPD-Min OB/ASUM2000/AC-Min OB/Jeanty/AC-Min OB/Hadlock/HC-Min OB/Hadlock/FL-Min OB/Hansmann/BPD-Min OB/Hansmann/CRL-Min OB/Hansmann/OFD-Min OB/Hansmann/HC-Min	(R-00388, SRT, '2 Sigma Lower Value of population')
OB/ASUM/BPD-Max OB/ASUM/AC-Max OB/ASUM2000/BPD-Max OB/ASUM2000/AC-Max OB/Jeanty/AC-Max OB/Hadlock/HC-Max OB/Hadlock/FL-Max OB/Hansmann/BPD-Max OB/Hansmann/CRL-Max OB/Hansmann/OFD-Max OB/Hansmann/ThD-Max OB/Hansmann/FL-Max OB/Rempen/GS-Max OB/Mercer/Ft-Max OB/Rempen/CRL-Max	(R-00387, SRT, '2 Sigma Upper Value of population')

OB/Eriksen/TAD-Min OB/Jeanty/CRL-Min OB/Hadlock/CRL-Min OB/Hansmann/TAD-Min OB/Hansmann/AC-Min OB/Hellman/GS-Min OB/Hansmann/ThD-Min OB/Hansmann/FL-Min OB/Rempen/GS-Min OB/Rempen/CRL-Min OB/Mercer/Ft-Min	(R-00347, SRT, '1 Sigma Lower Value of population')
OB/Eriksen/TAD-Max OB/Jeanty/CRL-Max OB/Hansmann/HC-Max OB/Hadlock/CRL-Max OB/Hansmann/TAD-Max OB/Hansmann/AC-Max OB/Hellman/GS-Max	(R-00346, SRT, '1 Sigma Upper Value of population')
OB/Jeanty/BPD-Min OB/Jeanty/HC-Min OB/Jeanty/FL-Min OB/Jeanty/ULNA-Min OB/Jeanty/HL-Min OB/Jeanty/TIB-Min OB/Merz/BPD-Min OB/Merz/AC-Min OB/Merz/HC-Min OB/Merz/FL-Min OB/Hadlock/BPD-Min OB/Hadlock/AC-Min	(R-00397, SRT, '5th Percentile Value of population')
OB/Jeanty/BPD-Max OB/Jeanty/HC-Max OB/Jeanty/FL-Max OB/Jeanty/ULNA-Max OB/Jeanty/HL-Max OB/Jeanty/TIB-Max OB/Merz/BPD-Max OB/Merz/AC-Max OB/Merz/HC-Max OB/Merz/FL-Max OB/Hadlock/BPD-Max OB/Hadlock/AC-Max	(R-00337, SRT, '95th Percentile Value of population')
standard deviation	(121414, DCM, "Standard deviation of population")

16.3.17 GEU Parameters Map to Context ID 12015 Fetal Growth Equations and Tables

TABLE 16-46 CONTEXT ID 12015

Name of GEU parameter	Base Measurement Concept Name
OB/Jeanty/FIB-GP	(33164-5, LN, 'Fibula by GA, Jeanty 1983')
OB/Jeanty/Radius-GP	(33180-1, LN, 'OB/Jeanty/Radius-GP')
OB/Merz/BPD-GP	(33154-6, LN, 'BPD by GA, Merz 1988')
OB/Merz/AC-GP	(33148-8, LN, 'AC by GA, Merz 1988')
OB/Merz/HC-GP	(33176-9, LN, 'HC by GA, Merz 1988')
OB/Merz/FL-GP	(33169-4, LN, 'FL by GA, Merz 1988')
OB/Hansmann/TTD-GA	(33136-3, LN, 'Transverse Thoracic Diameter, Hansmann 1985')
OB/Rempen/GS-GP	(33171-0, LN, 'GS by GA, Rempen 1991')
OB/Rempen/CRL-GP	(33160-3, LN, 'CRL by GA, Rempen 1991')

OB/Rempen/BPD-GP	(33155-3, LN, 'BPD by GA, Rempen 1991')
OB/ASUM2000/OFD-GA	(33119-9, LN, 'OFD, ASUM 2000')
OB/ASUM2000/CRL-GA	(33090-2, LN, 'CRL, ASUM 2000')
OB/ASUM2000/HC-GA	(33109-0, LN, 'HC, ASUM 2000')
OB/ASUM2000/AC-GA	(33072-0, LN, 'AC, ASUM 2000')
OB/ASUM2000/HL-GA	(33116-5, LN, 'Humerus Length, ASUM 2000')

16.3.18 GEU Parameters Map to Context ID 225 Measurement Uncertainty Concepts

TABLE 16-47 CONTEXT ID 225

Name of GEU parameter	Base Measurement Concept Name
+/- , range of measurement uncertainty	(R-00363, SRT, "+/- , Range of measurement uncertainty")
+ , range of upper measurement uncertainty	(R-00364, SRT, "+ , Range of upper measurement uncertainty")
- , range of lower measurement uncertainty	(R-00362, SRT, "- , Range of lower measurement uncertainty")

16.3.19 Context ID 3627 Extended Measurement Types

TABLE 16-48 CONTEXT ID 3627

GEU parameter attribute	Concept Modifier or Has Properties
Aver	(121401, DCM, 'Derivation') = (R-00317, SRT, 'Mean')
Max	(121401, DCM, 'Derivation') = (G-A437, SRT, 'Maximum')
Min	(121401, DCM, 'Derivation') = (R-404FB, SRT, 'Minimum')
Last	(121404, DCM, 'Selection Status') = (121411, DCM, 'Most recent value chosen')
'C'	(121401, DCM, 'Derivation') = (121428, DCM, 'Calculated')

16.3.20 Miscellaneous GEU Parameters Map to SR Coding Standards

TABLE 16-49 MISCELLANEOUS GEU PARAMETERS MAP

Name of GEU parameter	Base Measurement Concept Name
GA	(18185-9, LN, Gestational Age)
GP	(125012, DCM, Growth Percentile Rank)
OOR	(114009, DCM, Value out of range)
Side=Rt	(G-A100, SRT, Right)
Side=Lt	(G-A101, SRT, Left)

16.4 BREAST IMAGING REPORT

This section describes the contents of the Breast Imaging Report (TID 4200) SR.

16.4.1 Breast Imaging Report Template Structure supported by LOGIQ E8

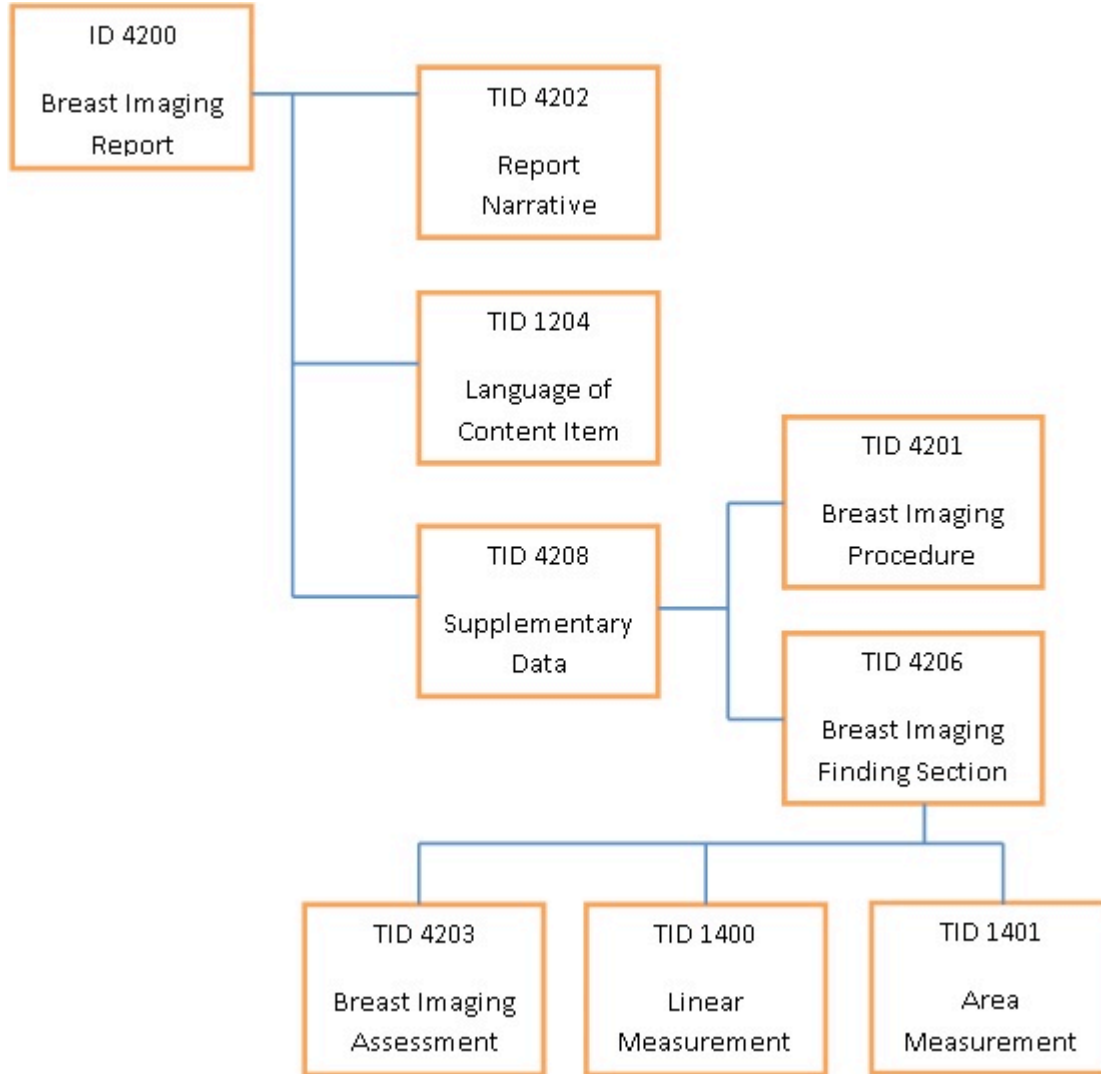

16.4.2 TID 4200 Breast Imaging Report

TABLE 16-50 TID 4200

	NL	Rel with Parent	VT	Concept Name	VM	Req Type	Condition	Value Set Constraint
1			CONTAINER	EV (111400, DCM, "Breast Imaging Report")	1	M		
2	>	HAS CONCEPT MOD	INCLUDE	DTID (1204) Language of Content Item and Descendants	1	M		
3	>	CONTAINS	INCLUDE	DTID (4202) Breast Imaging Report Narrative	1	M		
4	>	CONTAINS	INCLUDE	DTID (4208)	1	U		

DIR DOC1585895 REV 2

	NL	Rel with Parent	VT	Concept Name	VM	Req Type	Condition	Value Set Constraint
				Breast Imaging Report Supplementary Data				

16.4.3 TID 4201 Breast Imaging Procedure Reported

TABLE 16-51 TID 4201

	NL	Rel with Parent	VT	Concept Name	VM	Req Type	Condition	Value Set Constraint						
1			CODE	EV (121058, DCM, "Procedure reported")	1	M		(P5-B8500,SRT, "Ultrasonography of breast")						
2	>	HAS CONCEPT MOD	CODE	EV (G-C171, SRT, "Laterality")	1	M		<table border="1"> <thead> <tr> <th>GE Value</th> <th>DICOM Map</th> </tr> </thead> <tbody> <tr> <td>Lt</td> <td>(T-04030, SRT, "Left breast")</td> </tr> <tr> <td>Rt</td> <td>(T-04020, SRT, "Right breast")</td> </tr> </tbody> </table>	GE Value	DICOM Map	Lt	(T-04030, SRT, "Left breast")	Rt	(T-04020, SRT, "Right breast")
GE Value	DICOM Map													
Lt	(T-04030, SRT, "Left breast")													
Rt	(T-04020, SRT, "Right breast")													

16.4.4 TID 4202 Breast Imaging Report Narrative

TABLE 16-52 TID 4202

	NL	Rel with Parent	VT	Concept Name	V M	Req Type	Condition	Value Set Constraint
1			CONTAINER	EV (111412, DCM, "Narrative Summary")	1	M		
2	>	CONTAINS	CONTAINER	(121058, DCM, "Procedure reported")	1-n	M		
3	>>	CONTAINS	TEXT	EV (121058, DCM, "Procedure reported")	1	M		"Ultrasonography of breast"

16.4.5 TID 4203 Breast Imaging Assessment

TABLE 16-53 TID 4203

	NL	Rel with Parent	VT	Concept Name	VM	Req Type	Condition	Value Set Constraint
1			CODE	EV (111005, DCM, "Assessment Category")	1	M		DCID (6027) Mammography Assessment

16.4.6 TID 4206 Breast Imaging Report Finding Section

TABLE 16-54 TID 4206

	NL	Rel with Parent	VT	Concept Name	VM	Req Type	Condition	Value Set Constraint
1			CONTAINER	EV (121070, DCM, "Findings")	1	M		

	NL	Rel with Parent	VT	Concept Name	VM	Req Type	Condition	Value Set Constraint																																				
2	>	CONTAINS	INCLUDE	DTID (4201) Breast Imaging Procedure Reported	1	M																																						
3	>	CONTAINS	CODE	EV (121071, DCM, "Finding")	1-n	M		<table border="1"> <thead> <tr> <th>GE Value for Composition</th> <th>DICOM Map</th> </tr> </thead> <tbody> <tr> <td>-</td> <td>(GEU-1006-01, 99GEMS, "Lesion")</td> </tr> <tr> <td>Solid</td> <td>(111462, DCM, "Solid mass")</td> </tr> <tr> <td>Cystic</td> <td>(D7-90360, SRT, "Simple cyst of breast")</td> </tr> <tr> <td>Complex</td> <td>(111460, DCM, "Complex cyst")</td> </tr> </tbody> </table>	GE Value for Composition	DICOM Map	-	(GEU-1006-01, 99GEMS, "Lesion")	Solid	(111462, DCM, "Solid mass")	Cystic	(D7-90360, SRT, "Simple cyst of breast")	Complex	(111460, DCM, "Complex cyst")																										
GE Value for Composition	DICOM Map																																											
-	(GEU-1006-01, 99GEMS, "Lesion")																																											
Solid	(111462, DCM, "Solid mass")																																											
Cystic	(D7-90360, SRT, "Simple cyst of breast")																																											
Complex	(111460, DCM, "Complex cyst")																																											
4	>>	HAS PROPERTIES	INCLUDE	DTID (4203) Breast Imaging Assessment	1	U																																						
5	>>	HAS PROPERTIES	TEXT	(GEU-1006-03, 99GEMS, "Assessment Comment")	1	U																																						
6	>>	HAS PROPERTIES	CODE	<table border="1"> <thead> <tr> <th>GE Value</th> <th>DICOM Map</th> </tr> </thead> <tbody> <tr> <td>Position</td> <td>(111014, DCM, "Clockface or region")</td> </tr> </tbody> </table>	GE Value	DICOM Map	Position	(111014, DCM, "Clockface or region")	1	U		<table border="1"> <thead> <tr> <th>GE Value</th> <th>DICOM Map</th> </tr> </thead> <tbody> <tr> <td>1 OClock</td> <td>(F-01781, SRT, 1 o'clock position)</td> </tr> <tr> <td>2 OClock</td> <td>(F-01782, SRT, 2 o'clock position)</td> </tr> <tr> <td>3 OClock</td> <td>(F-01783, SRT, 3 o'clock position)</td> </tr> <tr> <td>4 OClock</td> <td>(F-01784, SRT, 4 o'clock position)</td> </tr> <tr> <td>5 OClock</td> <td>(F-01785, SRT, 5 o'clock position)</td> </tr> <tr> <td>6 OClock</td> <td>(F-01786, SRT, 6 o'clock position)</td> </tr> <tr> <td>7 OClock</td> <td>(F-01787, SRT, 7 o'clock position)</td> </tr> <tr> <td>8 OClock</td> <td>(F-01788, SRT, 8 o'clock position)</td> </tr> <tr> <td>9 OClock</td> <td>(F-01789, SRT, 9 o'clock position)</td> </tr> <tr> <td>10 OClock</td> <td>(F-0178A, SRT, 10 o'clock position)</td> </tr> <tr> <td>11 OClock</td> <td>(F-0178B, SRT, 11 o'clock position)</td> </tr> <tr> <td>12 OClock</td> <td>(F-0178C, SRT, 12 o'clock position)</td> </tr> <tr> <td>Areolar</td> <td>(F-0178F, SRT, Central region of breast)</td> </tr> <tr> <td>SubAreolar</td> <td>(F-0178D, SRT, Subareolar region)</td> </tr> <tr> <td>Axillary</td> <td>(F-01794, SRT, Axilla region)</td> </tr> </tbody> </table>	GE Value	DICOM Map	1 OClock	(F-01781, SRT, 1 o'clock position)	2 OClock	(F-01782, SRT, 2 o'clock position)	3 OClock	(F-01783, SRT, 3 o'clock position)	4 OClock	(F-01784, SRT, 4 o'clock position)	5 OClock	(F-01785, SRT, 5 o'clock position)	6 OClock	(F-01786, SRT, 6 o'clock position)	7 OClock	(F-01787, SRT, 7 o'clock position)	8 OClock	(F-01788, SRT, 8 o'clock position)	9 OClock	(F-01789, SRT, 9 o'clock position)	10 OClock	(F-0178A, SRT, 10 o'clock position)	11 OClock	(F-0178B, SRT, 11 o'clock position)	12 OClock	(F-0178C, SRT, 12 o'clock position)	Areolar	(F-0178F, SRT, Central region of breast)	SubAreolar	(F-0178D, SRT, Subareolar region)	Axillary	(F-01794, SRT, Axilla region)
GE Value	DICOM Map																																											
Position	(111014, DCM, "Clockface or region")																																											
GE Value	DICOM Map																																											
1 OClock	(F-01781, SRT, 1 o'clock position)																																											
2 OClock	(F-01782, SRT, 2 o'clock position)																																											
3 OClock	(F-01783, SRT, 3 o'clock position)																																											
4 OClock	(F-01784, SRT, 4 o'clock position)																																											
5 OClock	(F-01785, SRT, 5 o'clock position)																																											
6 OClock	(F-01786, SRT, 6 o'clock position)																																											
7 OClock	(F-01787, SRT, 7 o'clock position)																																											
8 OClock	(F-01788, SRT, 8 o'clock position)																																											
9 OClock	(F-01789, SRT, 9 o'clock position)																																											
10 OClock	(F-0178A, SRT, 10 o'clock position)																																											
11 OClock	(F-0178B, SRT, 11 o'clock position)																																											
12 OClock	(F-0178C, SRT, 12 o'clock position)																																											
Areolar	(F-0178F, SRT, Central region of breast)																																											
SubAreolar	(F-0178D, SRT, Subareolar region)																																											
Axillary	(F-01794, SRT, Axilla region)																																											
7	>>	HAS PROPERTIES	INCLUDE	DTID (1400) Linear Measurement	1-n	U																																						
8	>>	HAS PROPERTIES	INCLUDE	DTID (1401) Area Measurement	1-n	U																																						
9	>>	HAS PROPERTIES	NUM	(GEU-1006-07, 99GEMS, "A/B Ratio(area)")		U																																						
10	>>	HAS PROPERTIES	NUM	(GEU-1006-10, 99GEMS, "A/B Ratio(Diam)")		U																																						
11	>>	HAS PROPERTIES	CODE	<table border="1"> <thead> <tr> <th>GE Value</th> <th>DICOM Map</th> </tr> </thead> <tbody> <tr> <td>Segment</td> <td>(111020, DCM, "Depth")</td> </tr> </tbody> </table>	GE Value	DICOM Map	Segment	(111020, DCM, "Depth")	1	U		<table border="1"> <thead> <tr> <th>GE Value</th> <th>DICOM Map</th> </tr> </thead> <tbody> <tr> <td>A</td> <td>(G-A105, SRT, Anterior)</td> </tr> <tr> <td>B</td> <td>(G-A109, SRT, Middle)</td> </tr> <tr> <td>C</td> <td>(G-A106, SRT, Posterior)</td> </tr> </tbody> </table>	GE Value	DICOM Map	A	(G-A105, SRT, Anterior)	B	(G-A109, SRT, Middle)	C	(G-A106, SRT, Posterior)																								
GE Value	DICOM Map																																											
Segment	(111020, DCM, "Depth")																																											
GE Value	DICOM Map																																											
A	(G-A105, SRT, Anterior)																																											
B	(G-A109, SRT, Middle)																																											
C	(G-A106, SRT, Posterior)																																											

	NL	Rel with Parent	VT	Concept Name	VM	Req Type	Condition	Value Set Constraint																		
12	>>	HAS PROPERTIES	CODE	EV (M-020F9, SRT, "Shape")	1-n	U		<table border="1"> <thead> <tr> <th>GE Value</th> <th>DICOM Code</th> </tr> </thead> <tbody> <tr> <td>Oval</td> <td>(M-02120, SRT, "Ovoid shape (Oval)")</td> </tr> <tr> <td>Round</td> <td>(M-02100, SRT, "Round shape")</td> </tr> <tr> <td>Irregular</td> <td>(G-A402, SRT, "Irregular")</td> </tr> </tbody> </table>	GE Value	DICOM Code	Oval	(M-02120, SRT, "Ovoid shape (Oval)")	Round	(M-02100, SRT, "Round shape")	Irregular	(G-A402, SRT, "Irregular")										
GE Value	DICOM Code																									
Oval	(M-02120, SRT, "Ovoid shape (Oval)")																									
Round	(M-02100, SRT, "Round shape")																									
Irregular	(G-A402, SRT, "Irregular")																									
13	>>	HAS PROPERTIES	CODE	EV (111037, DCM, Margins")	1-n	U		<table border="1"> <thead> <tr> <th>GE Value</th> <th>DICOM Map</th> </tr> </thead> <tbody> <tr> <td>"Circumscribed"</td> <td>(F-01741, SRT, "Circumscribed lesion")</td> </tr> <tr> <td>"Indistinct"</td> <td>(F-01744, SRT, "Indistinct lesion")</td> </tr> <tr> <td>"Angular"</td> <td>(111343, DCM, "Angular margins")</td> </tr> <tr> <td>"Microlobulated"</td> <td>(F-01742, SRT, "Microlobulated lesion")</td> </tr> <tr> <td>"Spiculated"</td> <td>(F-01745, SRT, "Spiculated lesion")</td> </tr> </tbody> </table>	GE Value	DICOM Map	"Circumscribed"	(F-01741, SRT, "Circumscribed lesion")	"Indistinct"	(F-01744, SRT, "Indistinct lesion")	"Angular"	(111343, DCM, "Angular margins")	"Microlobulated"	(F-01742, SRT, "Microlobulated lesion")	"Spiculated"	(F-01745, SRT, "Spiculated lesion")						
GE Value	DICOM Map																									
"Circumscribed"	(F-01741, SRT, "Circumscribed lesion")																									
"Indistinct"	(F-01744, SRT, "Indistinct lesion")																									
"Angular"	(111343, DCM, "Angular margins")																									
"Microlobulated"	(F-01742, SRT, "Microlobulated lesion")																									
"Spiculated"	(F-01745, SRT, "Spiculated lesion")																									
14	>>	HAS PROPERTIES	CODE	<table border="1"> <thead> <tr> <th>GE Value</th> <th>DICOM Map</th> </tr> </thead> <tbody> <tr> <td>Calcifications</td> <td>(111009, DCM, "Calcification Type")</td> </tr> </tbody> </table>	GE Value	DICOM Map	Calcifications	(111009, DCM, "Calcification Type")	1-n	U		<table border="1"> <thead> <tr> <th>GE Value</th> <th>DICOM Map</th> </tr> </thead> <tbody> <tr> <td>"Macrocalcifications"</td> <td>(111345, DCM, Macrocalcifications)</td> </tr> <tr> <td>"Microcalcifications in mass"</td> <td>(111346, DCM, "Calcifications within a mass")</td> </tr> <tr> <td>"Microcalcifications out of mass"</td> <td>(111347, DCM, "Calcifications outside of a mass")</td> </tr> </tbody> </table>	GE Value	DICOM Map	"Macrocalcifications"	(111345, DCM, Macrocalcifications)	"Microcalcifications in mass"	(111346, DCM, "Calcifications within a mass")	"Microcalcifications out of mass"	(111347, DCM, "Calcifications outside of a mass")						
GE Value	DICOM Map																									
Calcifications	(111009, DCM, "Calcification Type")																									
GE Value	DICOM Map																									
"Macrocalcifications"	(111345, DCM, Macrocalcifications)																									
"Microcalcifications in mass"	(111346, DCM, "Calcifications within a mass")																									
"Microcalcifications out of mass"	(111347, DCM, "Calcifications outside of a mass")																									
15	>>	HAS PROPERTIES	CODE	<table border="1"> <thead> <tr> <th>GE Value</th> <th>DICOM Map</th> </tr> </thead> <tbody> <tr> <td>Special Cases</td> <td>(G-C189, SRT, "Associated Finding")</td> </tr> </tbody> </table>	GE Value	DICOM Map	Special Cases	(G-C189, SRT, "Associated Finding")	1-n	U		<table border="1"> <thead> <tr> <th>GE Value</th> <th>DICOM Map</th> </tr> </thead> <tbody> <tr> <td>"Clustered microcysts"</td> <td>(111129, DCM, "Clustered microcysts")</td> </tr> <tr> <td>"Complicated cysts"</td> <td>(111130, DCM, "Complicated cyst")</td> </tr> <tr> <td>"Mass in or on skin"</td> <td>(D7-90382, SRT, "Sebaceous cyst of skin of breast")</td> </tr> <tr> <td>"Foreign body"</td> <td>(M-30400, SRT, "Foreign body")</td> </tr> <tr> <td>"Lymph nodesintramammary"</td> <td>(T-C4351, SRT, "Intramammary lymph node")</td> </tr> <tr> <td>"Lymph nodesaxillary"</td> <td>(T-C4710, SRT, "Axillary lymph node")</td> </tr> </tbody> </table>	GE Value	DICOM Map	"Clustered microcysts"	(111129, DCM, "Clustered microcysts")	"Complicated cysts"	(111130, DCM, "Complicated cyst")	"Mass in or on skin"	(D7-90382, SRT, "Sebaceous cyst of skin of breast")	"Foreign body"	(M-30400, SRT, "Foreign body")	"Lymph nodesintramammary"	(T-C4351, SRT, "Intramammary lymph node")	"Lymph nodesaxillary"	(T-C4710, SRT, "Axillary lymph node")
GE Value	DICOM Map																									
Special Cases	(G-C189, SRT, "Associated Finding")																									
GE Value	DICOM Map																									
"Clustered microcysts"	(111129, DCM, "Clustered microcysts")																									
"Complicated cysts"	(111130, DCM, "Complicated cyst")																									
"Mass in or on skin"	(D7-90382, SRT, "Sebaceous cyst of skin of breast")																									
"Foreign body"	(M-30400, SRT, "Foreign body")																									
"Lymph nodesintramammary"	(T-C4351, SRT, "Intramammary lymph node")																									
"Lymph nodesaxillary"	(T-C4710, SRT, "Axillary lymph node")																									
16	>>	HAS PROPERTIES	CODE	EV (111354, DCM, "Orientation")	1	U		DCID (6152) Orientation																		
17	>>	HAS PROPERTIES	CODE	EV (111357, DCM, "Lesion boundary")	1	U		DCID (6153) Lesion boundary																		
18	>>	HAS PROPERTIES	CODE	EV (111360, DCM, "Echo pattern")	1	U		DCID (6154) Echo pattern																		
19	>>	HAS PROPERTIES	CODE	EV (111366, DCM, "Posterior acoustic features")	1	U		<table border="1"> <thead> <tr> <th>GE Value</th> <th>DICOM Map</th> </tr> </thead> <tbody> <tr> <td>"No posterior features"</td> <td>(111367, DCM, "No posterior acoustic features")</td> </tr> <tr> <td>"Enhancement"</td> <td>(111368, DCM, "Posterior enhancement")</td> </tr> <tr> <td>"Shadowing"</td> <td>(111369, DCM, "Posterior shadowing")</td> </tr> <tr> <td>"Combined Pattern"</td> <td>(111370, DCM, "Combined posterior enhancement and shadowing")</td> </tr> </tbody> </table>	GE Value	DICOM Map	"No posterior features"	(111367, DCM, "No posterior acoustic features")	"Enhancement"	(111368, DCM, "Posterior enhancement")	"Shadowing"	(111369, DCM, "Posterior shadowing")	"Combined Pattern"	(111370, DCM, "Combined posterior enhancement and shadowing")								
GE Value	DICOM Map																									
"No posterior features"	(111367, DCM, "No posterior acoustic features")																									
"Enhancement"	(111368, DCM, "Posterior enhancement")																									
"Shadowing"	(111369, DCM, "Posterior shadowing")																									
"Combined Pattern"	(111370, DCM, "Combined posterior enhancement and shadowing")																									

	NL	Rel with Parent	VT	Concept Name	VM	Req Type	Condition	Value Set Constraint	
20	>>	HAS PROPERTIES	CODE	EV (111371, DCM, "Identifiable effect on surrounding tissues")	1	U		GE Value	DICOM Map
								"Duct changes"	(GEU-1006-02, 99GEMS, "Duct changes")
								"Cooper ligament changes"	(111111, DCM, "Cooper's ligament changes")
								"Edema"	(F-01743, SRT, "Obscured lesion")
								"Architectural distortion"	(F-01795, SRT, "Architectural distortion of breast")
								"Skin thickening"	(F-0179A, SRT, "Skin thickening of breast")
21	>>	HAS PROPERTIES	CODE	EV (111372, DCM, "Vascularity")	1	U		GE Value	DICOM Map
								"Diffuse in surrounding tissue"	(111377, DCM, "Diffusely increased vascularity in surrounding tissue")
								"Not Present or not assessed"	(111373, DCM, "Vascularity not present")
								"Present in Lesion"	(111375, DCM, "Vascularity present in lesion")
								"Adjacent to Lesion"	(111376, DCM, "Vascularity present immediately adjacent to lesion")

16.4.7 TID 4208 Breast Imaging Report Supplementary Data

TABLE 16-55 TID 4208

	NL	Rel with Parent	VT	Concept Name	VM	Req Type	Condition	Value Set Constraint
1			CONTAINER	EV (111414, DCM, "Supplementary Data")	1	M		
2	>	CONTAINS	INCLUDE	DTID (4201) Breast Imaging Procedure Reported	1-n	M		
3	>	CONTAINS	INCLUDE	DTID (4206) Breast Imaging Report Finding Section	1-n	U		

16.4.8 TID 1400 Linear Measurement Template

TABLE 16-56 TID 1400

	NL	Rel with Parent	VT	Concept Name		VM	Req Type	Condition	Value Set Constraint
1			NUM	GE Measurement	DICOM Map	1	M		UNITS = DCID(7460) "Units of Linear Measurement"
				Length	(G-A22A, SRT, "Length")				
				Width	(G-A220, SRT, "Width")				
				Height	(121207, DCM, "Height")				
				SP/2D/DiamRatioD1	(GEU-1006-08, 99GEMS, "A/B Ratio(Diam) D1")				

NL	Rel with Parent	VT	Concept Name		VM	Req Type	Condition	Value Set Constraint
			SP/2D/DiamRatioD2	(GEU-1006-09, 99GEMS, "A/B Ratio(Diam) D2")				
			SP/2D/LesionDistToNipple	(121242, DCM, "Distance from nipple")				

16.4.9 TID 1401 Area Measurement Template

TABLE 16-57 TID 1401

NL	Rel with Parent	VT	Concept Name		VM	Req Type	Condition	Value Set Constraint
1		NUM	GE Measurement	DICOM Map	1	M		Value shall be > 0 UNITS = DCID(7461) "Units of Area Measurement"
			SP/2D/AreaRatioA1	(GEU-1006-05, 99GEMS, "A/B Ratio(area) A1")				
			SP/2D/AreaRatioA2	(GEU-1006-06, 99GEMS, "A/B Ratio(area) A2")				
			SP/2D/ACArea	(GEU-1006-11, 99GEMS, "Auto Contour Area")				

16.4.10 TID 1204 Language of Content Item and Descendants

TABLE 16-58 TID 1204

NL	Rel with Parent	VT	Concept Name	VM	Req Type	Condition	Value Set Constraint
1	HAS CONCEPT MOD	CODE	(121049,DCM,"Language of Content Item and Descendants")	1	M		(en, RFC3066, "English")

	NL	Rel with Parent	VT	Concept Name	V M	Req Type	Condition	Value Set Constraint
1			CONTAINER	(GEU-1007-01, 99GEMS, "Soft Tissue Neck and Head Imaging Report")	1	M		
2	>	HAS CONCEPT MOD	INCLUDE	DTID (1204) Language of Content Item and Descendants	1	M		
3	>	CONTAINS	INCLUDE	DTID (GEMS_US_SP_0101) Thyroid Imaging Finding Section	1	M		

16.5.3 TID GEMS_US_SP_0101

Thyroid Imaging Finding Section

TABLE 16-60 GEMS_US_SP_0101

	NL	Rel with Parent	VT	Concept Name	V M	Req Type	Condition	Value Set Constraint												
1			CONTAINER	EV (121070, DCM, "Findings")	1	M														
2	>	HAS CONCEPT MOD	CODE	EV (G-C0E3, SRT, "Finding Site")	1	M		EV (T-D1600, SRT, "Neck")												
3	>	HAS CONCEPT MOD	CODE	EV (G-0373, SRT, "Image Mode")	1	M		EV (G-03A2, SRT, "2D mode")												
4	>	CONTAINS	TEXT	EV (121106, DCM, "Comments")	1	U														
5	>	CONTAINS	CODE	EV(GEU-1007-03, 99GEMS,"Resected")	1	U		<table border="1"> <thead> <tr> <th>GE Value</th> <th>DICOM Map</th> </tr> </thead> <tbody> <tr> <td>"Totally"</td> <td>(GEU-1007-21, 99GEMS, "Totally")</td> </tr> <tr> <td>"Partially"</td> <td>(GEU-1007-22, 99GEMS, "Partially")</td> </tr> </tbody> </table>	GE Value	DICOM Map	"Totally"	(GEU-1007-21, 99GEMS, "Totally")	"Partially"	(GEU-1007-22, 99GEMS, "Partially")						
GE Value	DICOM Map																			
"Totally"	(GEU-1007-21, 99GEMS, "Totally")																			
"Partially"	(GEU-1007-22, 99GEMS, "Partially")																			
6	>	CONTAINS	CODE	EV(GEU-1007-04, 99GEMS,"Appearance")	1	U		<table border="1"> <thead> <tr> <th>GE Value</th> <th>DICOM Map</th> </tr> </thead> <tbody> <tr> <td>"Within normal limits"</td> <td>(GEU-1007-75, 99GEMS," Within normal limits")</td> </tr> <tr> <td>"Abnormal"</td> <td>(R-42037, SRT, "Abnormal")</td> </tr> <tr> <td>"Symmetric"</td> <td>(GEU-1007-05, 99GEMS,"Symmetric")</td> </tr> <tr> <td>"Asymmetric R>L"</td> <td>(GEU-1007-76, 99GEMS," Asymmetric R>L")</td> </tr> <tr> <td>"Asymmetric L>R"</td> <td>(GEU-1007-77, 99GEMS," Asymmetric L>R")</td> </tr> </tbody> </table>	GE Value	DICOM Map	"Within normal limits"	(GEU-1007-75, 99GEMS," Within normal limits")	"Abnormal"	(R-42037, SRT, "Abnormal")	"Symmetric"	(GEU-1007-05, 99GEMS,"Symmetric")	"Asymmetric R>L"	(GEU-1007-76, 99GEMS," Asymmetric R>L")	"Asymmetric L>R"	(GEU-1007-77, 99GEMS," Asymmetric L>R")
GE Value	DICOM Map																			
"Within normal limits"	(GEU-1007-75, 99GEMS," Within normal limits")																			
"Abnormal"	(R-42037, SRT, "Abnormal")																			
"Symmetric"	(GEU-1007-05, 99GEMS,"Symmetric")																			
"Asymmetric R>L"	(GEU-1007-76, 99GEMS," Asymmetric R>L")																			
"Asymmetric L>R"	(GEU-1007-77, 99GEMS," Asymmetric L>R")																			
7	>	CONTAINS	INCLUDE	DTID (GEMS_US_SP_0102) Thyroid Lobe Section	1	U		\$\$SectionLaterality = EV (G-A101, SRT, "Left")												
8	>	CONTAINS	INCLUDE	DTID (GEMS_US_SP_0102) Thyroid Lobe Section	1	U		\$\$SectionLaterality = EV (G-A100, SRT, "Right")												

	NL	Rel with Parent	VT	Concept Name	VM	Req Type	Condition	Value Set Constraint
9	>	CONTAINS	INCLUDE	DTID (GEMS_US_SP_0103) Lymph Node Section	1	U		\$SectionLaterality = EV (G-A101, SRT, "Left")
10	>	CONTAINS	INCLUDE	DTID (GEMS_US_SP_0103) Lymph Node Section	1	U		\$SectionLaterality = EV (G-A100, SRT, "Right")
11	>	CONTAINS	INCLUDE	DTID (GEMS_US_SP_0103) Lymph Node Section	1	U		\$SectionLaterality = EV (GEU-1007-47, 99GEMS, "Midline")
12	>	CONTAINS	INCLUDE	DTID (GEMS_US_SP_0104) Parathyroid Section	1	U		\$SectionLaterality = EV (G-A101, SRT, "Left")
13	>	CONTAINS	INCLUDE	DTID (GEMS_US_SP_0104) Parathyroid Section	1	U		\$SectionLaterality = EV (G-A100, SRT, "Right")
14	>	CONTAINS	INCLUDE	DTID (GEMS_US_SP_0105) Isthmus Section	1	U		

16.5.4 TID GEMS_US_SP_0102 Thyroid Lobe Section

TABLE 16-61 GEMS_US_SP_0102

Parameter Name	Parameter Usage
\$SectionLaterality	The laterality (if any) of the anatomy in this section heading

	NL	Rel with Parent	VT	Concept Name	VM	Req Type	Condition	Value Set Constraint												
1			CONTAINER	EV (T-B6000, SRT, "Thyroid")	1	M														
2	>	HAS CONCEPT MOD	CODE	EV (G-C171, SRT, "Laterality")	1	M		\$SectionLaterality												
3	>	CONTAINS	CODE	EV (GEU-1007-03, 99GEMS, "Resected")	1	U		<table border="1"> <thead> <tr> <th>GE Value</th> <th>DICOM Map</th> </tr> </thead> <tbody> <tr> <td>"Totally"</td> <td>EV (GEU-1007-21, 99GEMS, "Totally")</td> </tr> <tr> <td>"Partially"</td> <td>EV (GEU-1007-22, 99GEMS, "Partially")</td> </tr> </tbody> </table>	GE Value	DICOM Map	"Totally"	EV (GEU-1007-21, 99GEMS, "Totally")	"Partially"	EV (GEU-1007-22, 99GEMS, "Partially")						
GE Value	DICOM Map																			
"Totally"	EV (GEU-1007-21, 99GEMS, "Totally")																			
"Partially"	EV (GEU-1007-22, 99GEMS, "Partially")																			
4	>	CONTAINS	CODE	EV (GEU-1007-52, 99GEMS, "Echogenicity")	1	U		<table border="1"> <thead> <tr> <th>GE Value</th> <th>DICOM Map</th> </tr> </thead> <tbody> <tr> <td>"Homogeneous"</td> <td>(GEU-1007-23, 99GEMS, "Homogeneous")</td> </tr> <tr> <td>"Coarse"</td> <td>(GEU-1007-24, 99GEMS, "Coarse")</td> </tr> <tr> <td>"Heterogeneous"</td> <td>(GEU-1007-63, 99GEMS, "Heterogeneous")</td> </tr> <tr> <td>"HashimotoClassic"</td> <td>(GEU-1007-73, 99GEMS, "HashimotoClassic")</td> </tr> <tr> <td>"HashimotoP"</td> <td>(GEU-1007-74, 99GEMS,</td> </tr> </tbody> </table>	GE Value	DICOM Map	"Homogeneous"	(GEU-1007-23, 99GEMS, "Homogeneous")	"Coarse"	(GEU-1007-24, 99GEMS, "Coarse")	"Heterogeneous"	(GEU-1007-63, 99GEMS, "Heterogeneous")	"HashimotoClassic"	(GEU-1007-73, 99GEMS, "HashimotoClassic")	"HashimotoP"	(GEU-1007-74, 99GEMS,
GE Value	DICOM Map																			
"Homogeneous"	(GEU-1007-23, 99GEMS, "Homogeneous")																			
"Coarse"	(GEU-1007-24, 99GEMS, "Coarse")																			
"Heterogeneous"	(GEU-1007-63, 99GEMS, "Heterogeneous")																			
"HashimotoClassic"	(GEU-1007-73, 99GEMS, "HashimotoClassic")																			
"HashimotoP"	(GEU-1007-74, 99GEMS,																			

NL	Rel with Parent	VT	Concept Name	VM	Req Type	Condition	Value Set Constraint	
							robable"	"HashimotoProbable")
5 >	CONTAINS	CODE	EV (111372, DCM, "Vascularity")	1	U		GE Value	DICOM Map
							"Normal"	(GEU-1007-54, 99GEMS, "Normal")
							"Increased"	EV (111377, DCM, "Diffusely increased vascularity in surrounding tissue")
							"Decreased"	(GEU-1007-64, 99GEMS, "Decreased")
6 >	CONTAINS	CODE	EV (GEU-1007-53, 99GEMS, "Size")	1	U		GE Value	DICOM Map
							"Normal"	EV (R-404A9, SRT, "Medium")
							"Enlarged"	EV (R-404AA, SRT, "Large")
							"Small"	EV (R-404A8, SRT, "Small")
7 >	CONTAINS	TEXT	EV (121106, DCM, "Comments")	1	U			
8 >	CONTAINS	INCLUDE	DTID (1400) Linear Measurement	1-n	U			
9 >	CONTAINS	INCLUDE	DTID (1402) Volume Measurement	1	U			
10 >	CONTAINS	INCLUDE	DTID (GEMS_US_SP_0106) Nodules Section	1	U			

16.5.5 TID GEMS_US_SP_0103

Lymph Node Section

TABLE 16-62 GEMS_US_SP_0103

Parameter Name	Parameter Usage
\$SectionLaterality	The laterality (if any) of the anatomy in this section heading

NL	Rel with Parent	VT	Concept Name	VM	Req Type	Condition	Value Set Constraint	
1		CONTAINER	EV (GEU-1007-46, 99GEMS, "Lymph Nodes")	1	M			
2 >	HAS CONCEPT MOD	CODE	EV (G-C171, SRT, "Laterality")	1	M		\$SectionLaterality	
3 >	CONTAINS	CODE	EV (121071, DCM, "Finding")	1-n	M		GE Value for Composition	DICOM Map
							Solid	(111462, DCM, "Solid mass")
							Cystic	(GEU-1007-56, 99GEMS, "Cystic")
							Complex	(GEU-1007-61, 99GEMS, "Complex")
4 >>	HAS CONCEPT MOD	CODE	EV(GEU-1007-48, 99GEMS,"Location")	1	U		GE Value	DICOM Map
							"Submental"	(GEU-1007-38, 99GEMS, "Submental")
							"Submandibular"	(GEU-1007-39, 99GEMS, "Submandibular")
							"Parotid"	(GEU-1007-40, 99GEMS, "Parotid")

NL	Rel with Parent	VT	Concept Name	VM	Req Type	Condition	Value Set Constraint	
							"Upper cervical"	(GEU-1007-41, 99GEMS, "Upper cervical")
							"Middle cervical"	(GEU-1007-42, 99GEMS,"Middle cervical")
							"Lower cervical"	(GEU-1007-43, 99GEMS, "Lower cervical")
							"Supraclavicular fossa"	(GEU-1007-44, 99GEMS, "Supraclavicular fossa")
							"Posterior triangle"	(GEU-1007-45, 99GEMS, "Posterior triangle")
5 >>	HAS PROPERTIES	CODE	EV(GEU-1007-04, 99GEMS,"Appearance")	1	U		GE Value	DICOM Map
							"Within normal limits"	(GEU-1007-75, 99GEMS, "Within normal limits")
							"Pathologic"	(GEU-1007-07, 99GEMS, "Pathologic")
							"Suspicious"	(GEU-1007-70, 99GEMS, "Suspicious")
6 >>	HAS PROPERTIES	CODE	EV (111372, DCM, "Vascularity")	1	U		GE Value	DICOM Map
							"Normal"	EV (GEU-1007-54, 99GEMS, "Normal")
							"Increased hilar"	(GEU-1007-71, 99GEMS, "Increased hilar")
							"Increased non-hilar"	(GEU-1007-72, 99GEMS, "Increased non-hilar")
7 >>	HAS PROPERTIES	TEXT	EV (121106, DCM, "Comments")	1	U			
8 >>	HAS PROPERTIES	INCLUDE	DTID (1400) Linear Measurement	1-n	U			
9 >>	HAS PROPERTIES	NUM	EV(GEU-1007-13, 99GEMS, "Cortical Thickness")	1	U		UNITS = DCID(7460) "Units of Linear Measurement"	

16.5.6 TID GEMS_US_SP_0104

Parathyroid Section

TABLE 16-63 GEMS_US_SP_0104

Parameter Name	Parameter Usage
\$SectionLaterality	The laterality (if any) of the anatomy in this section heading

NL	Rel with Parent	VT	Concept Name	VM	Req Type	Condition	Value Set Constraint	
1		CONTAINER	EV (T-B7000, SRT, "Parathyroid")	1	M			
2 >	HAS CONCEPT MOD	CODE	EV (G-C171, SRT, "Laterality")	1	M		\$SectionLaterality	
3 >	CONTAINS	CODE	EV (121071, DCM, "Finding")	1-n	M		EV (T-B7000, SRT, "Parathyroid")	
4 >>	HAS	CODE	EV(GEU-1007-51,	1	U		GE Value	DICOM Map

NL	Rel with Parent	VT	Concept Name	VM	Req Type	Condition	Value Set Constraint						
	PROPERTIES		99GEMS,"Visibility")				<table border="1"> <tr> <td>"Visualized"</td> <td>(GEU-1007-10, 99GEMS," Visualized")</td> </tr> <tr> <td>"Not Visualized"</td> <td>(GEU-1007-55, 99GEMS," Not Visualized")</td> </tr> </table>	"Visualized"	(GEU-1007-10, 99GEMS," Visualized")	"Not Visualized"	(GEU-1007-55, 99GEMS," Not Visualized")		
"Visualized"	(GEU-1007-10, 99GEMS," Visualized")												
"Not Visualized"	(GEU-1007-55, 99GEMS," Not Visualized")												
5 >>	HAS CONCEPT MOD	CODE	EV(GEU-1007-48, 99GEMS,"Location")	1	U		<table border="1"> <tr> <td>GE Value</td> <td>DICOM Map</td> </tr> <tr> <td>"Upper Gland"</td> <td>(GEU-1007-49, 99GEMS," Upper Gland")</td> </tr> <tr> <td>"Lower Gland"</td> <td>(GEU-1007-50, 99GEMS," Lower Gland")</td> </tr> </table>	GE Value	DICOM Map	"Upper Gland"	(GEU-1007-49, 99GEMS," Upper Gland")	"Lower Gland"	(GEU-1007-50, 99GEMS," Lower Gland")
GE Value	DICOM Map												
"Upper Gland"	(GEU-1007-49, 99GEMS," Upper Gland")												
"Lower Gland"	(GEU-1007-50, 99GEMS," Lower Gland")												
6 >>	HAS PROPERTIES	TEXT	EV (121106, DCM, "Comments")	1	U								
7 >>	HAS PROPERTIES	INCLUDE	DTID (1400) Linear Measurement	1-n	U								

16.5.7 TID GEMS_US_SP_0105 Isthmus Section

TABLE 16-64 GEMS_US_SP_0105

NL	Rel with Parent	VT	Concept Name	VM	Req Type	Condition	Value Set Constraint
1		CONTAINER	EV (GEU-1007-02, 99GEMS, "Isthmus")	1	M		
2 >	CONTAINS	TEXT	EV (121106, DCM, "Comments")	1	U		
3 >	CONTAINS	NUM	EV(GEU-1007-12, 99GEMS, "Isthmus AP")	1	U		UNITS = DCID(7460) "Units of Linear Measurement"
4 >	CONTAINS	INCLUDE	DTID (GEMS_US_SP_0106) Nodules Section	1	U		

16.5.8 TID GEMS_US_SP_0106 Nodules Section

TABLE 16-65 GEMS_US_SP_0106

NL	Rel with Parent	VT	Concept Name	VM	Req Type	Condition	Value Set Constraint												
1		CONTAINER	EV (GEU-1007-27, 99GEMS, "Nodules")	1	M														
2 >	CONTAINS	CODE	EV (121071, DCM, "Finding")	1-n	M		<table border="1"> <tr> <td>GE Value for Composition</td> <td>DICOM Map</td> </tr> <tr> <td>Solid</td> <td>(111462, DCM, "Solid mass")</td> </tr> <tr> <td>Cystic</td> <td>(GEU-1007-56, 99GEMS, "Cystic")</td> </tr> <tr> <td>Mixed</td> <td>(GEU-1007-20, 99GEMS, "Mixed")</td> </tr> <tr> <td>Complex</td> <td>(GEU-1007-60, 99GEMS, "Complex")</td> </tr> <tr> <td>Heterogeneous</td> <td>(GEU-1007-62, 99GEMS, "Heterogeneous")</td> </tr> </table>	GE Value for Composition	DICOM Map	Solid	(111462, DCM, "Solid mass")	Cystic	(GEU-1007-56, 99GEMS, "Cystic")	Mixed	(GEU-1007-20, 99GEMS, "Mixed")	Complex	(GEU-1007-60, 99GEMS, "Complex")	Heterogeneous	(GEU-1007-62, 99GEMS, "Heterogeneous")
GE Value for Composition	DICOM Map																		
Solid	(111462, DCM, "Solid mass")																		
Cystic	(GEU-1007-56, 99GEMS, "Cystic")																		
Mixed	(GEU-1007-20, 99GEMS, "Mixed")																		
Complex	(GEU-1007-60, 99GEMS, "Complex")																		
Heterogeneous	(GEU-1007-62, 99GEMS, "Heterogeneous")																		
3 >>	HAS CONCEPT MOD	CODE	EV (GEU-1007-28, 99GEMS, "Location A")	1	U		<table border="1"> <tr> <td>GE Value</td> <td>DICOM Code</td> </tr> <tr> <td>"Upper"</td> <td>(GEU-1007-29, 99GEMS, "Upper")</td> </tr> <tr> <td>"Mid"</td> <td>(GEU-1007-30, 99GEMS, "Mid")</td> </tr> </table>	GE Value	DICOM Code	"Upper"	(GEU-1007-29, 99GEMS, "Upper")	"Mid"	(GEU-1007-30, 99GEMS, "Mid")						
GE Value	DICOM Code																		
"Upper"	(GEU-1007-29, 99GEMS, "Upper")																		
"Mid"	(GEU-1007-30, 99GEMS, "Mid")																		

NL	Rel with Parent	VT	Concept Name	VM	Req Type	Condition	Value Set Constraint	
							"Lower"	(GEU-1007-31, 99GEMS, "Lower")
4	>> HAS CONCEPT MOD	CODE	EV (GEU-1007-32, 99GEMS, "Location B")	1	U		GE Value	DICOM Code
							"Lateral"	(GEU-1007-33, 99GEMS, "Lateral")
							"Mid"	(GEU-1007-30, 99GEMS, "Mid")
							"Medial"	(GEU-1007-34, 99GEMS, "Medial")
5	>> HAS PROPERTIES	CODE	EV (GEU-1007-14, 99GEMS, "Shape")	1	U		GE Value	DICOM Code
							Oval	(M-02120, SRT, "Ovoid shape (Oval)")
							Round	(M-02100, SRT, "Round shape")
							Lobulated	(G-A640, SRT, "Lobular")
							Irregular	(G-A402, SRT, "Irregular")
6	>> HAS PROPERTIES	CODE	EV (GEU-1007-35, 99GEMS, "Margin")	1	U		GE Value	DICOM Code
							"Well-Defined"	(R-40771, SRT, "Well defined")
							"Well-Defined with halo"	(GEU-1007-08, 99GEMS, "Well-Defined with halo")
							"Well-Defined with partial halo"	(GEU-1007-09, 99GEMS, "Well-Defined with partial halo")
							"Well-defined with complete halo"	(GEU-1007-57, 99GEMS, "Well-defined with complete halo")
							"Poorly defined"	(R-428E7, SRT, "Poorly defined")
							"Irregular"	(G-A402, SRT, "Irregular")
7	>> HAS PROPERTIES	CODE	EV (111372, DCM, "Vascularity")	1	U		GE Value	DICOM Map
							"Normal"	EV (GEU-1007-54, 99GEMS, "Normal")
							"Increased"	EV (111377, DCM, "Diffusely increased vascularity in surrounding tissue")
							"Decreased"	(GEU-1007-64, 99GEMS, "Decreased")
							"Central vasc avascular"	(GEU-1007-65, 99GEMS, "Central vasc avascular")
							"Central vasc hypovascular"	(GEU-1007-66, 99GEMS, "Central vasc hypovascular")
							"Central vasc isovascular"	(GEU-1007-67, 99GEMS, "Central vasc isovascular")
							"Central vasc hypervascular"	(GEU-1007-68, 99GEMS, "Central vasc hypervascular")
							"Central vasc severely hypervascular"	(GEU-1007-69, 99GEMS, "Central vasc severely hypervascular")

NL	Rel with Parent	VT	Concept Name	VM	Req Type	Condition	Value Set Constraint	
							GE Value	DICOM Map
8 >>	HAS PROPERTIES	CODE	EV (GEU-1007-37, 99GEMS, "Calcification")				"No calcification"	(GEU-1007-78, 99GEMS, "No calcification")
							"Coarse central"	EV (GEU-1007-15, 99GEMS, "Coarse central")
							"Coarse rim"	EV (GEU-1007-16, 99GEMS, "Coarse rim")
							"Punctate scattered"	EV (GEU-1007-79, 99GEMS, "Punctate scattered")
							"Punctate clumped"	EV (GEU-1007-80, 99GEMS, "Punctate clumped")
							"Colloid"	EV (GEU-1007-19, 99GEMS, "Colloid")
							"Mixed"	EV (GEU-1007-20, 99GEMS, "Mixed")
							9 >>	HAS PROPERTIES
10 >>	HAS PROPERTIES	INCLUDE	DTID (1400) Linear Measurement	1-n	U			
11 >>	HAS PROPERTIES	INCLUDE	DTID (1402) Volume Measurement	1	U			

16.5.9 TID 1400 Linear Measurement Template

TABLE 16-66 TID 1400

NL	Rel with Parent	VT	Concept Name		VM	Req Type	Condition	Value Set Constraint
1		NUM	GE Measurement	DICOM Map	1	M		UNITS = DCID(7460) "Units of Linear Measurement"
			Length	(G-A22A, SRT, "Length")				
			Width	(G-A220, SRT, "Width")				
			Height	(121207, DCM, "Height")				

16.5.10 TID 1402 Volume Measurement Template

TABLE 16-67 TID 1402

NL	Rel with Parent	VT	Concept Name	VM	Req Type	Condition	Value Set Constraint
1		NUM	EV(G-D705, SRT, "Volume")	1	M		Value shall be > 0 UNITS = DCID(7462) "Units of Volume Measurement"

DIR DOC1585895 REV 2

16.5.11 TID 1204 Language of Content Item and Descendants

TABLE 16-68 TID 1204

	NL	Rel with Parent	VT	Concept Name	VM	Req Type	Condition	Value Set Constraint
1		HAS CONCEPT MOD	CODE	(121049,DCM,"Language of Content Item and Descendants")	1	M		(en, RFC3066, "English")

16.6 KEY OBJECT SELECTION DOCUMENT TEMPLATE

This section describes the contents of the Key Object Selection Document Template (TID 2010) SR.

16.6.1 TID 2010 Template**TABLE 16-69 TID 2010 KEY OBJECT SELECTION DOCUMENT**

	NL	Rel with Parent	VT	Concept Name	VM	Req Type	Condition	Value Set Constraint
1			CONTAINER	(DCM, 113001, "Rejected for Quality Reasons")	1	M		
2	>	HAS CONCEPT MOD	INCLUDE	DTID(1204) Language of Content Item and Descendants	1	U		(en, RFC3066, "English")
3	>	HAS OBS CONTEXT	INCLUDE	DTID(1002) Observer Context	1-n	U		
4	>	CONTAIN S	TEXT	EV(113012, DCM, "Key Object Description")	1	U		"List of Rejected Images for Quality"
5	>	CONTAIN S	IMAGE	Purpose of Reference shall not be present	1-n	MC		List of image instance UIDs that are marked for deletion

16.7 GE ULTRASOUND M&A REPORT

LOGIQ E8 supports the following private templates GEMS_US_0100 for SOP Instances created by this product when exam types selected are Small Parts, Urology and Pediatrics.

16.7.1 TID GEMS_US_0100 Template

TABLE 16-70 GEMS_US_0100

	NL	Relation with Parent	Value Type	Concept Name	VM	Req Type	Condition	Value Set Constraint
			CONTAINER	EV (43126, 99GEMS, 'ultrasound M&A Document')	1	M		
	>	CONTAINS	UIDREF	EV (43140, 99GEMS, 'Series Instance UID')	1	U		
	>	CONTAINS	TEXT	EV(29463-7, LN, 'Patient Weight')	1	U		
	>	CONTAINS	TEXT	EV(8302-2, LN, 'Patient Height')	1	U		
	>	CONTAINS	TEXT	EV (43148, 99GEMS, 'Ultrasound Category')	1	U		
	>	CONTAINS	TEXT	EV (11878-6, LN, 'Number of Fetuses')	1	U		
	>	CONTAINS	TEXT	EV(43139, 99GEMS, 'EDD method')	1	U		
	>	CONTAINS	CONTAINER	(43127, 99GEMS, "ultrasound parameter")	1-n	U		
	>>	CONTAINS	TEXT	(43127, 99GEMS, "ultrasound parameter averaging method")	1	M		
	>>	CONTAINS	TEXT	(43143, 99GEMS, "ultrasound display mode")	1	M		
	>>	CONTAINS	TEXT	(43132, 99GEMS, "ultrasound parameter preferred display unit")	1	M		
	>>	CONTAINS	TEXT	(43137, 99GEMS, "ultrasound parameter value, manually edited")	1	M		
	>>	CONTAINS	TEXT	(43135, 99GEMS, "ultrasound parameter, exclude from averaging")	1	M		
	>>	CONTAINS	TEXT	(43136, 99GEMS, "ultrasound parameter, exclude from calculation")	1	M		
	>>	CONTAINS	TEXT	(43148, 99GEMS, "ultrasound category")	1	M		
	>>	CONTAINS	TEXT	(43141, 99GEMS, "ultrasound parameter, mark deleted")	1	M		
	>>	CONTAINS	TEXT	(43149, 99GEMS, "ultrasound parameter, srStudy text")	1	M		
	>>	CONTAINS	TEXT	(43146, 99GEMS, "ultrasound parameter, measurement tool")	1	M		
	>>	CONTAINS	TEXT	(43144, 99GEMS,	1	M		

				“ultrasound image mode”)				
	>>	CONTAINS	TEXT	(43131, 99GEMS, “ultrasound parameter ID”)	1	M		
	>>	CONTAINS	TEXT	(43133, 99GEMS, “ultrasound parameter preferred display name”)	1	M		
	>>	CONTAINS	TEXT	(43134, 99GEMS, “ultrasound parameter value source”)	1	M		
	>>	CONTAINS	TEXT	(43142, 99GEMS, “Result Number”)	1	M		
	>>	CONTAINS	TEXT	(43145, 99GEMS, “ultrasound study type”)	1	M		
	>>	CONTAINS	TEXT	(43129, 99GEMS, “ultrasound parameter textual value”)	1	M		
	>>	CONTAINS	NUM	(43128, 99GEMS, “ultrasound parameter numeric value”)	1	M		