



GE Medical Systems

Technical Publications

**Direction 2381100-100
Revision 1**

Advantage Workstation 4.2

**CONFORMANCE STATEMENT
for DICOM**

do not duplicate

Copyright© 2003 By General Electric Co.

THIS PAGE LEFT INTENTIONALLY BLANK

REVISION HISTORY

Rev	Date	Reason for change
0	August 14 th , 2003	Release AW4.3 02
1	October 15 th , 2003	Release AW4.2 03

THIS PAGE LEFT INTENTIONALLY BLANK

TABLE OF CONTENTS

1. INTRODUCTION.....	1-1
1.1 OVERVIEW.....	1-1
1.2 OVERALL DICOM CONFORMANCE STATEMENT DOCUMENT STRUCTURE.....	1-2
1.3 INTENDED AUDIENCE.....	1-3
1.4 SCOPE AND FIELD OF APPLICATION.....	1-3
1.5 IMPORTANT REMARKS.....	1-4
1.6 REFERENCES.....	1-4
1.7 DEFINITIONS.....	1-5
1.8 SYMBOLS AND ABBREVIATIONS.....	1-5
2. NETWORK CONFORMANCE STATEMENT.....	2-1
2.1 INTRODUCTION.....	2-1
2.2 IMPLEMENTATION MODEL.....	2-1
2.2.1 Application Data Flow Diagram.....	2-1
2.2.2 Functional Definition of AE's.....	2-3
2.2.3 Sequencing of Real-World Activities.....	2-4
2.3 AE SPECIFICATIONS.....	2-5
2.3.1 DICOM SERVER AE Specification.....	2-5
2.3.2 DICOM STORAGE COMMITMENT SERVER AE Specification.....	2-29
2.4 COMMUNICATION PROFILES.....	2-34
2.4.1 Supported Communication Stacks (PS 3.8, PS 3.9).....	2-34
2.4.2 OSI Stack.....	2-34
2.4.3 TCP/IP Stack.....	2-34
2.4.4 Point-to-Point Stack.....	2-35
2.5 EXTENSIONS / SPECIALIZATIONS / PRIVATIZATIONS.....	2-35
2.5.1 Standard Extended /Specialized/Private SOPs.....	2-35
2.5.2 Private Transfer Syntaxes.....	2-35
2.6 CONFIGURATION.....	2-35
2.6.1 AE Title/Presentation Address Mapping.....	2-35
2.6.2 Configurable Parameters.....	2-36
2.7 SUPPORT OF EXTENDED CHARACTER SETS.....	2-36
3. MEDIA STORAGE CONFORMANCE STATEMENT.....	3-1
3.1 INTRODUCTION.....	3-1

3.2	IMPLEMENTATION MODEL	3-1
3.2.1	Application Data Flow Diagram	3-1
3.2.2	Functional Definition of AE's.....	3-3
3.2.3	Functional Definition of the DICOM Media Server AE.....	3-3
3.2.4	Sequencing Requirements.....	3-3
3.3	AE SPECIFICATIONS.....	3-3
3.3.1	DICOM CDR/CDROM SERVER AE Specification.....	3-3
3.3.2	DICOM MOD SERVER AE Specification	3-8
3.4	Augmented and Private Application Profiles.....	3-12
3.4.1	Augmented Application Profiles.....	3-12
3.4.2	Private Application Profiles	3-14
3.5	EXTENSIONS, SPECIALIZATIONS, PRIVATIZATIONS of SOP Classes and Transfer Syntaxes	3-14
3.5.1	Extensions, Specializations, and Privatizations of SOP Classes.....	3-14
3.5.2	Private Transfer Syntax Specification.....	3-16
3.6	CONFIGURATION.....	3-16
3.7	SUPPORT OF EXTENDED CHARACTER SETS.....	3-16
4.	NETWORK PRINT SCU CONFORMANCE STATEMENT	4-1
4.1	INTRODUCTION	4-1
4.2	IMPLEMENTATION MODEL	4-1
4.2.1	Application Data Flow Diagram	4-1
4.2.2	Functional Definition of AE'S	4-2
4.2.3	Sequencing of Real-World Activities	4-2
4.3	AE Specifications	4-3
4.3.1	DICOM Print SCU AE Specification	4-3
4.4	COMMUNICATION PROFILES.....	4-5
4.4.1	Supported Communication Stacks (PS 3.8, PS 3.9).....	4-5
4.4.2	OSI Stack	4-5
4.4.3	TCP/IP Stack.....	4-5
4.4.4	Point-to-Point Stack.....	4-5
4.5	EXTENSIONS / SPECIALIZATIONS / PRIVATIZATIONS.....	4-6
4.5.1	Standard Extended /Specialized/Private SOP Classes	4-6
4.5.2	Private Transfer Syntaxes	4-6
4.5.3	CONFIGURATION.....	4-6
4.6	SUPPORT OF EXTENDED CHARACTER SETS.....	4-7
5.	PRINT MANAGEMENT SOP CLASS DEFINITION	5-1
5.1	INTRODUCTION	5-1
5.2	Print management SOP class definitions.....	5-1
5.2.1	Basic Film Session SOP Class	5-1
5.2.2	Basic Film Box SOP Class.....	5-3
5.2.3	Image Box SOP Classes.....	5-7
5.2.4	Printer SOP Class.....	5-12
5.2.5	Print Job SOP Class	5-14
5.2.6	Basic Annotation Box SOP Class	5-14

5.2.7	Image Overlay Box SOP Class	5-14
6.	SC INFORMATION OBJECT IMPLEMENTATION	6-1
6.1	introduction	6-1
6.2	SC Entity-Relationship Model	6-1
6.2.1	ENTITY DESCRIPTIONS	6-2
6.2.2	Advantage Workstation 4.2 Mapping of DICOM entities	6-2
6.3	SC-IOD MODULE TABLE	6-2
6.4	SC-INFORMATION MODULE DEFINITIONS	6-3
6.4.1	Common Patient Entity Modules	6-4
6.4.2	Common Study Entity Modules	6-4
6.4.3	Common Series Entity Modules	6-7
6.4.4	Common Equipment Entity Modules	6-7
6.4.5	Common Image Entity Modules	6-8
6.4.6	Overlay Plan Modules	6-10
6.4.7	Lookup Table Modules	6-11
6.4.8	General Modules	6-13
6.4.9	SC Modules	6-13
6.5	SC-PRivate data dictionary	6-14
7.	ENHANCED SR INFORMATION OBJECT IMPLEMENTATION	7-16
7.1	introduction	7-16
7.2	ENHANCED SR Entity-Relationship Model	7-16
7.2.1	ENTITY DESCRIPTIONS	7-17
7.2.2	Advantage Workstation 4.2 Mapping of DICOM entities	7-18
7.3	ENHANCED SR-IOD MODULE TABLE	7-18
7.4	ENHANCED SR -INFORMATION MODULE DEFINITIONS	7-19
7.4.1	Common Patient Entity Modules	7-19
7.4.2	Common Study Entity Modules	7-19
7.4.3	SR Document Series Entity Modules	7-21
7.4.4	Common Equipment Entity Modules	7-21
7.4.5	SR document Entity Modules	7-22
7.4.6	General Modules	7-23
7.5	ENHANCE SR – PRIVATE DATA DICTIONARY	7-23
7.6	ENHANCE SR – TEMPLATE IDENTIFICATION	7-24
7.6.1	TID Electronic Film Presentation	7-24
7.6.2	TID Page Presentation	7-24
7.6.3	TID Slot Group Presentation	7-24
7.6.4	TID Slot Presentation	7-24
7.6.5	TID Cine Sequence	7-25
7.6.6	TID Geometry	7-25
7.7	ENHANCE SR - Private Coded Entries	7-25
8.	PRIVATE OBJECT INFORMATION OBJECT IMPLEMENTATION	8-1

8.1	introduction	8-1
8.2	DPO Entity-Relationship Model.....	8-1
8.2.1	ENTITY DESCRIPTIONS	8-2
8.2.2	Advantage Workstation 4.2 Mapping of DICOM entities	8-2
8.3	DPO-IOD MODULE TABLE.....	8-2
8.4	DPO-INFORMATION MODULE DEFINITIONS.....	8-3
8.4.1	Common Patient Entity Modules	8-4
8.4.2	Common Study Entity Modules.....	8-4
8.4.3	Common Series Entity Modules	8-6
8.4.4	Common Equipment Entity Modules.....	8-6
8.4.5	DPO Modules.....	8-6
8.5	DPO-PRIVate data dictionary.....	8-7

1. INTRODUCTION

1.1 OVERVIEW

This DICOM Conformance Statement is divided into Sections as described below:

Section 1 (Introduction) describes the overall structure, intent, and references for this Conformance Statement

Section 2 (Network Conformance Statement) specifies the GEMS equipment compliance to the DICOM requirements for the implementation of networking features.

Section 3 (Media Storage Conformance Statement) specifies the GEMS equipment compliance to the DICOM requirements for the implementation of Media Storage features

Section 4 (Network Print SCU Conformance Statement) specifies the GEMS equipment compliance to the DICOM requirements for the implementation of Network Print features.

Section 5 (Network Print Management SOP Class definition) specifies the GEMS equipment compliance to the DICOM requirements for the implementation of Network Print Management SOP Class.

Section 6 (SC Information Object Implementation) specifies the GEMS equipment compliance to the DICOM requirements for the implementation of SC Information Object Implementation feature.

Section 7 (ENHANCED SR Object Implementation) specifies the GEMS equipment compliance to the DICOM requirements for the implementation of Enhanced SR Information Object Implementation feature.

Section 8 (DPO Information Object Implementation) specifies the GEMS equipment compliance to the DICOM requirements for the implementation of the private DPO Information Object Implementation feature. (DPO stands for DICOM Private Object)

1.2 OVERALL DICOM CONFORMANCE STATEMENT DOCUMENT STRUCTURE

The Documentation Structure of the GEMS Conformance Statements and their relationship with the DICOM Conformance Statements is shown in the Illustration below.

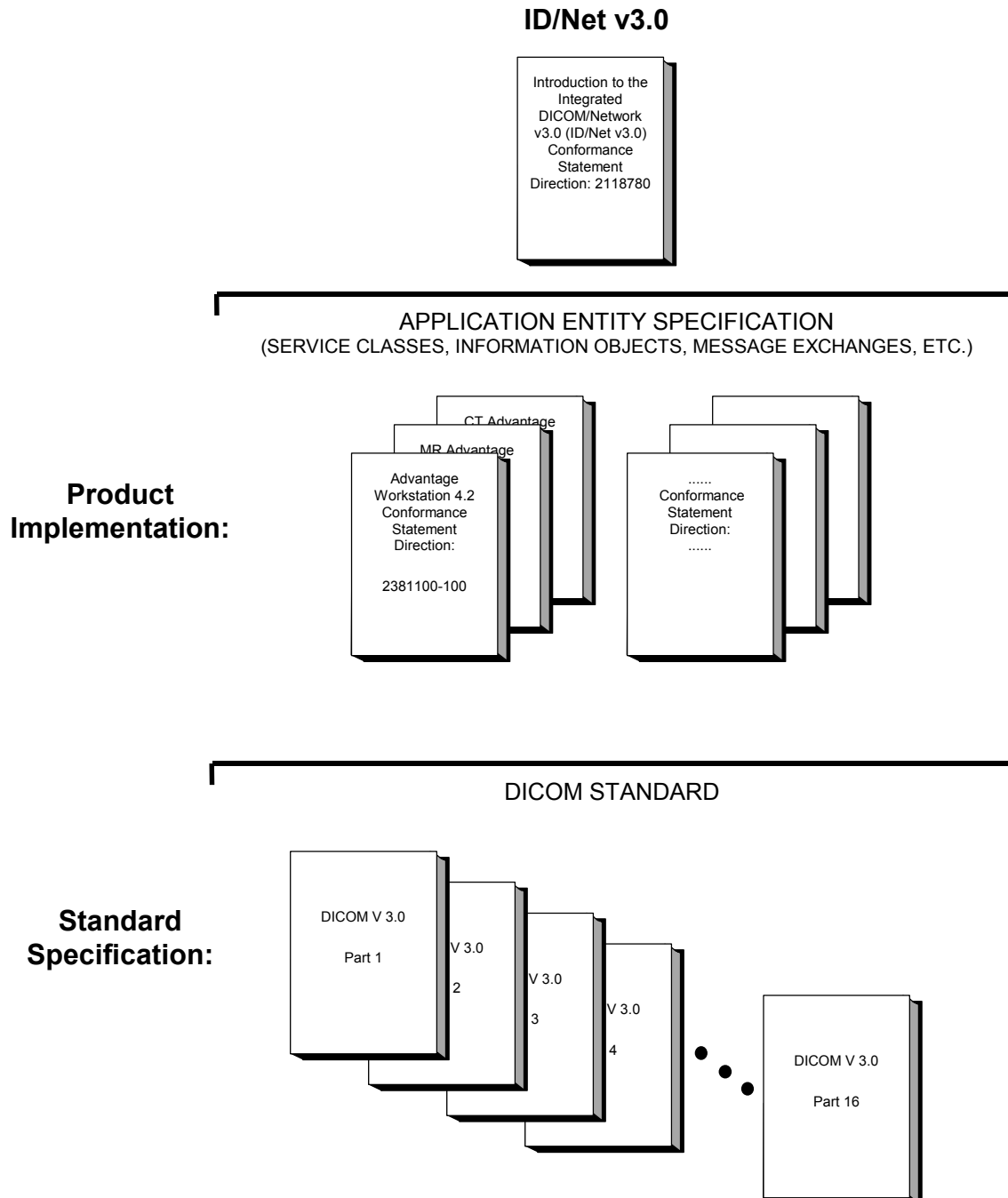

This document specifies the DICOM implementation. It is entitled:

*Advantage Workstation 4.2
Conformance Statement for DICOM
Direction 2381100-100*

This DICOM Conformance Statement documents the DICOM Conformance Statement and Technical Specification required to interoperate with the GEMS network interface. Introductory information, which is applicable to all GEMS Conformance Statements, is described in the document:

Introduction to the Integrated DICOM/Network (ID/Net v3.0)
Conformance Statement
Direction: 2118780.

This Introduction familiarizes the reader with DICOM terminology and general concepts. It should be read prior to reading the individual products' GEMS Conformance Statements.

The GEMS Conformance Statement, contained in this document, also specifies the Lower Layer communications, which it supports (e.g., TCP/IP). However, the Technical Specifications are defined in the DICOM Part 8 standard.

For more information including Network Architecture and basic DICOM concepts, please refer to the Introduction.

For more information regarding DICOM, copies of the Standard may be obtained on the Internet at:

<http://medical.nema.org>

Comments on the standard may be addressed to:

DICOM Secretariat
NEMA
1300 North 17th Street, Suite 1847
Rosslyn, VA 22209 USA

1.3 INTENDED AUDIENCE

The reader of this document is concerned with software design and/or system integration issues. It is assumed that the reader of this document is familiar with the DICOM Standards and with the terminology and concepts, which are used in those Standards.

If readers are unfamiliar with DICOM terminology they should first refer to the document listed below, then read the DICOM Standard itself, prior to reading this DICOM Conformance Statement document.

Introduction to the Integrated DICOM/Network (ID/Net v3.0)
Conformance Statement
Direction: 2118780

1.4 SCOPE AND FIELD OF APPLICATION

It is the intent of this document, in conjunction with the *Introduction to the Integrated DICOM/Network (ID/Net v3.0) Conformance Statement, Direction: 2118780*, to provide an unambiguous specification for GEMS implementations. This specification, called a Conformance Statement, includes a DICOM Conformance Statement and is necessary to ensure proper processing and interpretation of GEMS medical data exchanged using DICOM. The GEMS Conformance Statements are available to the public.

The reader of this DICOM Conformance Statement should be aware that different GEMS devices are capable of using different Information Object Definitions. For example, a GEMS CT Scanner may send images using the CT Information Object, MR Information Object, Secondary Capture Object, etc.

Included in this DICOM Conformance Statement are the Module Definitions, which define all data elements, used by this GEMS implementation. If the user encounters unspecified private data elements while parsing a GEMS Data Set, the user is well advised to ignore those data elements (per the DICOM standard). Unspecified private data element information is subject to change without notice. If, however, the device is acting as a "full fidelity storage device", it should retain and re-transmit all of the private data elements, which are sent by GEMS devices.

1.5 IMPORTANT REMARKS

The use of these DICOM Conformance Statements, in conjunction with the DICOM Standards, is intended to facilitate communication with GE imaging equipment. However, **by itself, it is not sufficient to ensure that inter-operation will be successful**. The **user (or user's agent)** needs to proceed with caution and address at least four issues:

- **Integration** - The integration of any device into an overall system of interconnected devices goes beyond the scope of standards (DICOM), and of this introduction and associated DICOM Conformance Statements when interoperability with non-GE equipment is desired. The responsibility to analyze the applications requirements and to design a solution that integrates GE imaging equipment with non-GE systems is the **user's** responsibility and should not be underestimated. The **user** is strongly advised to ensure that such an integration analysis is correctly performed.
- **Validation** - Testing the complete range of possible interactions between any GE device and non-GE devices, before the connection is declared operational, should not be overlooked. Therefore, the **user** should ensure that any non-GE provider accepts full responsibility for all validation required for their connection with GE devices. This includes the accuracy of the image data once it has crossed the interface between the GE imaging equipment and the non-GE device and the stability of the image data for the intended applications.

Such a validation is required before any clinical use (diagnosis and/or treatment) is performed. It applies when images acquired on GE imaging equipment are processed/displayed on a non-GE device, as well as when images acquired on non-GE equipment is processed/displayed on a GE console or workstation.

- **Future Evolution** - GE understands that the DICOM Standard will evolve to meet the user's growing requirements. GE is actively involved in the development of the DICOM Standard. DICOM will incorporate new features and technologies and GE may follow the evolution of the Standard. The GEMS protocol is based on DICOM as specified in each DICOM Conformance Statement. Evolution of the Standard may require changes to devices, which have implemented DICOM. **In addition, GE reserves the right to discontinue or make changes to the support of communications features (on its products) reflected on by these DICOM Conformance Statements**. The **user** should ensure that any non-GE provider, which connects with GE devices, also plans for the future evolution of the DICOM Standard. Failures to do so will likely result in the loss of function and/or connectivity as the DICOM Standard changes and GE Products are enhanced to support these changes.
- **Interaction** - It is the sole responsibility of the **non-GE provider** to ensure that communication with the interfaced equipment does not cause degradation of GE imaging equipment performance and/or function.

1.6 REFERENCES

A list of references, which is applicable, to all GEMS Conformance Statements is included in the *Introduction to the Integrated DICOM/Network (ID/Net v3.0) Conformance Statement, Direction: 2118780*.

The information object implementation refers to DICOM PS 3.3 (Information Object Definition).

The media storage implementation refers to DICOM supplement 14, which describes the “General Purpose Profile” for writing CD-Rs, and to supplement 18, which describes the DICOM CT/MR profile.

1.7 DEFINITIONS

A set of definitions which is applicable to all GEMS Conformance Statements is included in *the Introduction to the Integrated DICOM/Network (ID/Net v3.0) Conformance Statement, Direction: 2118780.*

1.8 SYMBOLS AND ABBREVIATIONS

A list of symbols and abbreviations which is applicable to all GEMS Conformance Statements is included in *the Introduction to the Integrated DICOM/Network (ID/Net v3.0) Conformance Statement, Direction: 2118780.*

THIS PAGE LEFT INTENTIONALLY BLANK

2. NETWORK CONFORMANCE STATEMENT

2.1 INTRODUCTION

This section of the DICOM Conformance Statement specifies the compliance to DICOM conformance requirements for the relevant **Networking** features on this GEMS product. Note that the format of this section strictly follows the format defined in DICOM Standard PS 3.2 (Conformance). Please refer to that part of the standard while reading this section.

The Advantage Workstation 4.2 is a Networked Medical Imaging Console dedicated to Examination Review and Diagnosis on film. The workstation uses DICOM services to import images for possible further analysis or processing and to export images to other DICOM implementations, DICOM printers or DICOM Interchange media. It also uses the DICOM Storage Commitment service to transfer ownership of images to a remote workstation supporting storage commitment such as an archive system.

The station provides a basis for applications built on top of it. These applications can create specific Information Object Definitions that will be described in the conformance statement of the added applications. The added applications can benefit the network facilities provided by the station.

This DICOM conformance statement refers to DICOM Supplement 4, 6, 11 for the description of standard IODs.

This DICOM conformance statement refers to other DICOM conformance statements for formal descriptions of IODs created by added applications:

- GE Private 3D Model Objects are described in the Advantage Windows Vxtool 2.0 DICOM Conformance Statement (Direction Number: 2198583-100)
- GE Private DICOM RT Plan are described in the Advantage SIM 3.0 DICOM Conformance Statement (Direction Number: 2192581-100)
- GE private DICOM NM images are described in the GENIE™ Processing & Review R2.6 DICOM Conformance Statement (Direction number: 2260424-100)
- GE private DICOM PET images are described in the Advance 4.05 DICOM Conformance Statement (Direction number: 2270669-100 Rev. 0.3)

2.2 IMPLEMENTATION MODEL

2.2.1 Application Data Flow Diagram

The Basic and Specific Application models for this station are shown in the following Illustration:

DICOM SERVER AE APPLICATION MODEL

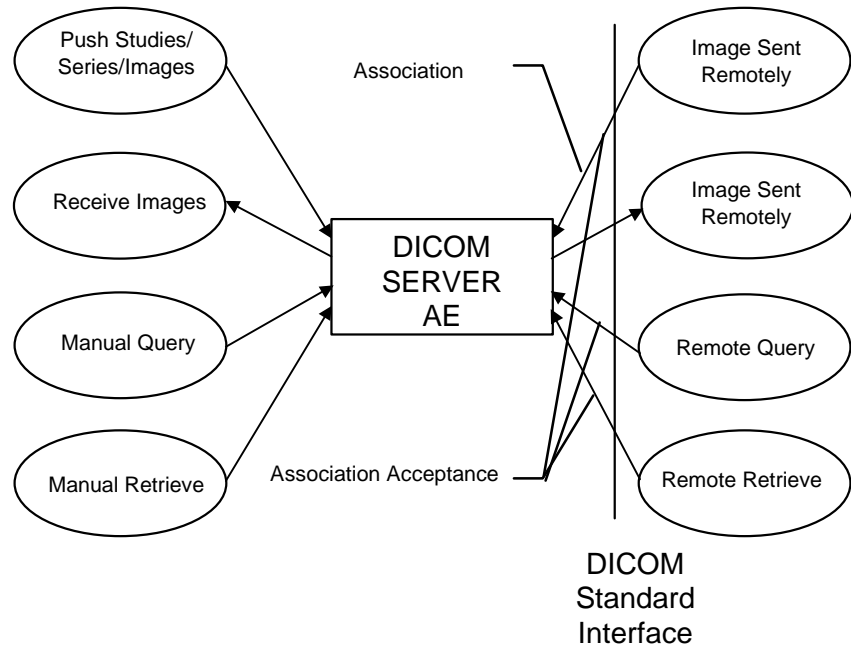

Note: The DICOM SERVER AE accepts also the DICOM Verification SOP class as a SCP. It is not indicated on the illustration above.

The DICOM SERVER Application Entity (AE) is an application that handles DICOM protocol communication. The DICOM SERVER AE is automatically brought up when the Advantage Workstation 4.2 is powered on.

The DICOM SERVER AE is invoked by the following Real World Activities:

- Push Studies/Series/Images.

For this operation, the operator selects some studies, series or images on the console browser and then sends the selected studies, series or images on one or several remote DICOM AE by a drag and drop on the icon that represents the wanted remote DICOM AE. The transfer activity is displayed on a specific icon.

The declaration of remote DICOM AE is done through a specific application (known as NETWORK MANAGEMENT).

- Manual Query

For this operation, the operator queries a remote database to obtain a list of data at Patient/Study/Series/Image level by clicking on the icon that represents the wanted remote DICOM AE. The query is selective based on criteria described below in the document.

- Manual Retrieve

Once the remote browser is displayed (Manual Query), the operator can retrieve the SOP Classes supported by the Advantage Workstation 4.2 from the remote DICOM AE. The data can be retrieved at the Patient/Study/Series/Image level.

- Receive images from a Remote DICOM AE

When images are installed in the local database, the local Patient List displays the content of the Advantage Workstation 4.2 local database.

- Remote Query

For this operation, a remote DICOM AE asks to obtain the list of data at Study/Series/Image level.

- Remote Retrieve

For this operation, a remote DICOM AE asks to send data at Study/Series/Image level from the local AE to another DICOM Remote AE. The remote DICOM AE can ask to move the SOP Classes supported by the Advantage Workstation 4.2 at the Patient/Study/Series/Image level. The Remote DICOM AE shall be declared locally on the Advantage Workstation 4.2. The declaration of remote DICOM AE is done through a specific application (known as NETWORK MANAGEMENT).

DICOM STORAGE COMMITMENT SERVER AE APPLICATION MODEL

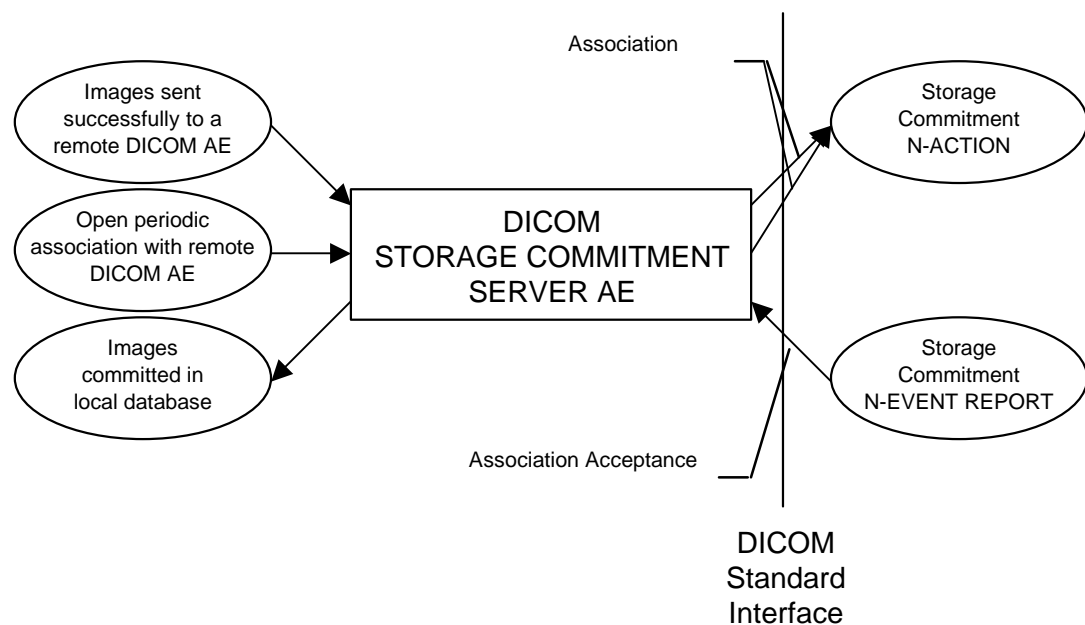

Note: The STORAGE COMMITMENT SERVER AE accepts also the DICOM Verification SOP class as a SCP. It is not indicated on the illustration above.

The DICOM STORAGE COMMITMENT SERVER AE is invoked by the following Real World Activities:

- Initiate Storage Commitment to a Remote DICOM AE.
- Listen to remote Storage Commitment SCP.
- Open periodic associations.

2.2.2 Functional Definition of AE's

DICOM SERVER AE

The DICOM SERVER AE initiates the following operations:

- Access to patient demographics and pixel data in the local database.
- Build a DICOM format data set.

- Initiate a DICOM association to send DICOM SOP Classes to a remote DICOM AE.
- Initiate a DICOM association to ask for remote patient demographics.
- Initiate a DICOM association to ask for transmitting images from a remote DICOM AE to Advantage Workstation 4.2.

The DICOM SERVER AE waits for association requests from Remote AE:

- Answer to DICOM associations transmitting DICOM SOP Classes to be stored on the Advantage Workstation 4.2.
- Answer to DICOM associations transmitting Verification SOP Class to the Advantage Workstation 4.2.

STORAGE COMMITMENT SERVER AE:

The STORAGE COMMITMENT SERVER AE initiates the following operations:

- Initiate a DICOM association to ask for the storage commitment of specific images and wait for a Storage Commitment Notification (N-EVENT-REPORT)
- Initiate a DICOM association and wait for a Storage Commitment Notification (N-EVENT-REPORT)

The STORAGE COMMITMENT SERVER AE waits for association requests from Remote Storage Commitment AE:

- Answer to DICOM associations transmitting Storage Commitment Notification (N-EVENT-REPORT)

2.2.3 Sequencing of Real-World Activities

DICOM SERVER AE:

Not applicable.

DICOM STORAGE COMMITMENT SERVER AE:

1. The user selects the images and sends them to a remote host.
2. If the remote DICOM AE is associated with a Storage Commitment Provider AE and if the images are successfully sent to the DICOM AE, then a N-ACTION-RQ request is sent automatically to the associated Storage Commitment Provider AE.
3. Waits for N-ACTION-RSP from a remote Storage Commitment Provider AE.
4. On reception of failure in N-ACTION-RSP, the Storage Commitment AE logs the error, displays a pop-up and stops.
5. On reception of success, Storage Commitment AE is ready to receive at any time from Storage Commitment Provider the N-EVENT-REPORT-RQ notification.
6. On reception of a successful N-EVENT-REPORT-RQ notification from Storage Commitment Provider, the images are flagged as committed in the database.
7. The Storage Commitment AE sends a N-EVENT-REPORT-RSP to the Storage Commitment Provider

8. The Storage Commitment AE opens periodic association with all the DICOM AE that have been declared as Storage Commitment Provider on the station. The time between these associations is configurable.

2.3 AE SPECIFICATIONS

2.3.1 DICOM SERVER AE Specification

This Application Entity provides Standard Conformance to the following DICOM SOP Classes as a SCU:

SOP Class Name	SOP Class UID
Computed Radiography Image Storage	1.2.840.10008.5.1.4.1.1.1
CT Image Storage	1.2.840.10008.5.1.4.1.1.2
MR Image Storage	1.2.840.10008.5.1.4.1.1.4
Secondary Capture Image Storage	1.2.840.10008.5.1.4.1.1.7
X-Ray Angiographic Image Storage	1.2.840.10008.5.1.4.1.1.12.1
X-Ray Radiofluoroscopic Image Storage	1.2.840.10008.5.1.4.1.1.12.2
Digital X-Ray Image Storage - For Presentation	1.2.840.10008.5.1.4.1.1.1.1
Digital X-Ray Image Storage - For Processing	1.2.840.10008.5.1.4.1.1.1.1.1
Digital Mammography X-Ray Image Storage - For Presentation	1.2.840.10008.5.1.4.1.1.1.2
Digital Mammography X-Ray Image Storage - For Processing	1.2.840.10008.5.1.4.1.1.1.2.1
Nuclear Medicine Image Storage	1.2.840.10008.5.1.4.1.1.20
Standalone Curve Storage	1.2.840.10008.5.1.4.1.1.9
Positron Emission Tomography Image Storage	1.2.840.10008.5.1.4.1.1.128
Standalone PET Curve Storage	1.2.840.10008.5.1.4.1.1.129
RT Image Storage	1.2.840.10008.5.1.4.1.1.481.1
RT Structure Set Storage	1.2.840.10008.5.1.4.1.1.481.3
RT Plan Storage	1.2.840.10008.5.1.4.1.1.481.5
GE Private DICOM RT Plan	1.2.840.113619.4.5.249
NM Genie Private Data	1.2.840.113619.4.27
PET Advance Private Data	1.2.840.113619.4.30
GE Private DICOM 3D Object	1.2.840.113619.4.26
Ultrasound Image Storage	1.2.840.10008.5.1.4.1.1.6.1
Ultrasound Multi-frame Image Storage	1.2.840.10008.5.1.4.1.1.3.1
Ultrasound Image Storage (Retired)	1.2.840.10008.5.1.4.1.1.6

Ultrasound Multi-frame Image Storage (Retired)	1.2.840.10008.5.1.4.1.1.3
Basic Text SR	1.2.840.10008.5.1.4.1.1.88.11
Enhanced SR	1.2.840.10008.5.1.4.1.1.88.22
Comprehensive SR	1.2.840.10008.5.1.4.1.1.88.33
Mammography CAD SR	1.2.840.10008.5.1.4.1.1.88.50
Study Root Query/Retrieve Information Model - FIND	1.2.840.10008.5.1.4.1.2.2.1
Patient Root Query/Retrieve Information Model - MOVE	1.2.840.10008.5.1.4.1.2.1.2
Study Root Query/Retrieve Information Model - MOVE	1.2.840.10008.5.1.4.1.2.2.2

Note: C-FIND is done using Study Root Information Model.

Note: C-MOVE is done either using Patient Root Information Model when the operator asks for retrieving different patient folders all together at a time or Study Root Information Model in other cases.

Note: Please also refer to sections 6 for Network Print Management SCU Conformance Statement.

This Application Entity provides Standard Conformance to the following DICOM SOP Classes as a **SCP**:

SOP Class Name	SOP Class UID
Computed Radiography Image Storage	1.2.840.10008.5.1.4.1.1.1
CT Image Storage	1.2.840.10008.5.1.4.1.1.2
MR Image Storage	1.2.840.10008.5.1.4.1.1.4
Secondary Capture Image Storage	1.2.840.10008.5.1.4.1.1.7
Standalone Overlay Storage	1.2.840.10008.5.1.4.1.1.8
X-Ray Angiographic Image Storage	1.2.840.10008.5.1.4.1.1.12.1
X-Ray Radiofluoroscopic Image Storage	1.2.840.10008.5.1.4.1.1.12.2
Digital X-Ray Image Storage - For Presentation	1.2.840.10008.5.1.4.1.1.1.1
Digital X-Ray Image Storage - For Processing	1.2.840.10008.5.1.4.1.1.1.1.1
Digital Mammography X-Ray Image Storage - For Presentation	1.2.840.10008.5.1.4.1.1.1.2
Digital Mammography X-Ray Image Storage - For Processing	1.2.840.10008.5.1.4.1.1.1.2.1
Nuclear Medicine Image Storage	1.2.840.10008.5.1.4.1.1.20
Standalone Curve Storage	1.2.840.10008.5.1.4.1.1.9
Positron Emission Tomography Image Storage	1.2.840.10008.5.1.4.1.1.128
Standalone PET Curve Storage	1.2.840.10008.5.1.4.1.1.129

RT Image Storage	1.2.840.10008.5.1.4.1.1.481.1
RT Structure Set Storage	1.2.840.10008.5.1.4.1.1.481.3
RT Plan Storage	1.2.840.10008.5.1.4.1.1.481.5
GE Private DICOM RT Plan	1.2.840.113619.4.5.249
NM Genie Private Data	1.2.840.113619.4.27
PET Advance Private Data	1.2.840.113619.4.30
GE Private DICOM 3D Object	1.2.840.113619.4.26
Ultrasound Image Storage	1.2.840.10008.5.1.4.1.1.6.1
Ultrasound Multi-frame Image Storage	1.2.840.10008.5.1.4.1.1.3.1
Ultrasound Image Storage (Retired)	1.2.840.10008.5.1.4.1.1.6
Ultrasound Multi-frame Image Storage (Retired)	1.2.840.10008.5.1.4.1.1.3
Basic Text SR	1.2.840.10008.5.1.4.1.1.88.11
Enhanced SR	1.2.840.10008.5.1.4.1.1.88.22
Comprehensive SR	1.2.840.10008.5.1.4.1.1.88.33
Mammography CAD SR	1.2.840.10008.5.1.4.1.1.88.50
Study Root Query/Retrieve Information Model - FIND	1.2.840.10008.5.1.4.1.2.2.1
Patient Root Query/Retrieve Information Model - MOVE	1.2.840.10008.5.1.4.1.2.1.2
Study Root Query/Retrieve Information Model - MOVE	1.2.840.10008.5.1.4.1.2.2.2
Verification SOP Class	1.2.840.10008.1.1

2.3.1.1 Association Establishment Policies

2.3.1.1.1 General

The DICOM Application Context Name (ACN), which is always proposed, is:

Application Context Name	1.2.840.10008.3.1.1.1
---------------------------------	------------------------------

The maximum length PDU negotiation is included in all association establishment requests.

The maximum length PDU for an association initiated by the DICOM SERVER AE is:

Maximum Length PDU	28672 Bytes
---------------------------	--------------------

Note: The SOP Class Extended Negotiation is not supported.

Note: The user information Items sent by this product are:

- Maximum PDU Length

- Implementation UID

2.3.1.1.2 Number of Associations

The DICOM SERVER AE will initiate only one DICOM association at a time to perform a DICOM store operation as a SCU to a Remote Host AE.

The DICOM SERVER AE will initiate only one DICOM association at a time to perform a DICOM Query/Retrieve operation as a SCU with a Remote Host AE.

The DICOM SERVER AE can have a maximum of 4 open DICOM associations at a time to perform a DICOM operation as a SCP.

2.3.1.1.3 Asynchronous Nature

Asynchronous mode is not supported. All operations will be performed synchronously.

2.3.1.1.4 Implementation Identifying Information

The Implementation UID for this DICOM Implementation is:

Advantage Workstation 4.2 Implementation UID	1.2.840.113619.6.144
--	----------------------

2.3.1.1.5 Real-World Activity: Push Studies/Series/Images to Remote AE

2.3.1.1.5.1 Associated Real-World Activity

The operator selects in the BROWSER one or several Studies (or Series/Images) to be sent. Then, the user can either drag and drop the selection on the icon representing then Remote DICOM AE, or click on the “Push” icon and select a Remote DICOM AE in the LIST OF REMOTE HOST.

This operation will cause the following actions:

- The Advantage Workstation 4.2 will load a DICOM image from its database.
- The DICOM SERVER AE will initiate a DICOM association, negotiate with the Remote AE an appropriate Abstract and Transfer Syntax.
- The DICOM SERVER AE will emit a C-STORE command to send the image, if the negotiation is successful.

2.3.1.1.5.2 Association Initiation Policy

The DICOM SERVER AE initiates a new association for each Study (or Series/Images) selected by the operator to be pushed to a remote DICOM AE. Each association corresponds to one Real World Activity:

- Push Studies/Series/images

2.3.1.1.5.3 Proposed Presentation Context

The following table shows the proposed presentation contexts for the DICOM Server AE after Real-World Activity “Push” Operation has been performed.

Presentation Context Table - Proposed					
Abstract Syntax		Transfer Syntax		Role	Extended Negotiation
Name	UID	Name List	UID List		
Computed Radiography Image Storage	1.2.840.10008.5.1.4.1.1.1	Implicit VR Little Endian	1.2.840.10008.1.2	SCU	None
Computed Radiography Image Storage	1.2.840.10008.5.1.4.1.1.1	Explicit VR Little Endian	1.2.840.10008.1.2.1	SCU	None
Computed Radiography Image Storage	1.2.840.10008.5.1.4.1.1.1	Explicit VR Big Endian	1.2.840.10008.1.2.2	SCU	None
CT Image Storage	1.2.840.10008.5.1.4.1.1.2	Implicit VR Little Endian	1.2.840.10008.1.2	SCU	None
CT Image Storage	1.2.840.10008.5.1.4.1.1.2	Explicit VR Little Endian	1.2.840.10008.1.2.1	SCU	None
CT Image Storage	1.2.840.10008.5.1.4.1.1.2	Explicit VR Big Endian	1.2.840.10008.1.2.2	SCU	None
MR Image Storage	1.2.840.10008.5.1.4.1.1.4	Implicit VR Little Endian	1.2.840.10008.1.2	SCU	None
MR Image Storage	1.2.840.10008.5.1.4.1.1.4	Explicit VR Little Endian	1.2.840.10008.1.2.1	SCU	None
MR Image Storage	1.2.840.10008.5.1.4.1.1.4	Explicit VR Big Endian	1.2.840.10008.1.2.2	SCU	None
X-Ray Angiographic Image Storage	1.2.840.10008.5.1.4.1.1.1 2.1	Implicit VR Little Endian	1.2.840.10008.1.2	SCU	None
X-Ray Angiographic Image Storage	1.2.840.10008.5.1.4.1.1.1 2.1	Explicit VR Little Endian	1.2.840.10008.1.2.1	SCU	None
X-Ray Angiographic Image Storage	1.2.840.10008.5.1.4.1.1.1 2.1	Explicit VR Big Endian	1.2.840.10008.1.2.2	SCU	None
X-Ray Radiofluoroscopic Image Storage	1.2.840.10008.5.1.4.1.1.1 2.2	Implicit VR Little Endian	1.2.840.10008.1.2	SCU	None
X-Ray Radiofluoroscopic Image Storage	1.2.840.10008.5.1.4.1.1.1 2.2	Explicit VR Little Endian	1.2.840.10008.1.2.1	SCU	None
X-Ray Radiofluoroscopic Image Storage	1.2.840.10008.5.1.4.1.1.1 2.2	Explicit VR Big Endian	1.2.840.10008.1.2.2	SCU	None
Secondary Capture Image Storage	1.2.840.10008.5.1.4.1.1.7	Implicit VR Little Endian	1.2.840.10008.1.2	SCU	None
Secondary Capture Image Storage	1.2.840.10008.5.1.4.1.1.7	Explicit VR Little Endian	1.2.840.10008.1.2.1	SCU	None
Secondary Capture Image Storage	1.2.840.10008.5.1.4.1.1.7	Explicit VR Big Endian	1.2.840.10008.1.2.2	SCU	None
Digital X-Ray Image Storage - For Presentation	1.2.840.10008.5.1.4.1.1.1.1	Implicit VR Little Endian	1.2.840.10008.1.2	SCU	None
Digital X-Ray Image Storage - For Presentation	1.2.840.10008.5.1.4.1.1.1.1	Explicit VR Little Endian	1.2.840.10008.1.2.1	SCU	None

- For Presentation	1				
Digital X-Ray Image Storage - For Presentation	1.2.840.10008.5.1.4.1.1.1.1	Explicit VR Big Endian	1.2.840.10008.1.2.2	SCU	None
Digital X-Ray Image Storage - For Processing	1.2.840.10008.5.1.4.1.1.1.1.1	Implicit VR Little Endian	1.2.840.10008.1.2	SCU	None
Digital X-Ray Image Storage - For Processing	1.2.840.10008.5.1.4.1.1.1.1.1	Explicit VR Little Endian	1.2.840.10008.1.2.1	SCU	None
Digital X-Ray Image Storage - For Processing	1.2.840.10008.5.1.4.1.1.1.1.1	Explicit VR Big Endian	1.2.840.10008.1.2.2	SCU	None
Digital Mammography X-Ray Image Storage - For Presentation	1.2.840.10008.5.1.4.1.1.1.2	Implicit VR Little Endian	1.2.840.10008.1.2	SCU	None
Digital Mammography X-Ray Image Storage - For Presentation	1.2.840.10008.5.1.4.1.1.1.2	Explicit VR Little Endian	1.2.840.10008.1.2.1	SCU	None
Digital Mammography X-Ray Image Storage - For Presentation	1.2.840.10008.5.1.4.1.1.1.2	Explicit VR Big Endian	1.2.840.10008.1.2.2	SCU	None
Digital Mammography X-Ray Image Storage - For Processing	1.2.840.10008.5.1.4.1.1.1.2.1	Implicit VR Little Endian	1.2.840.10008.1.2	SCU	None
Digital Mammography X-Ray Image Storage - For Processing	1.2.840.10008.5.1.4.1.1.1.2.1	Explicit VR Little Endian	1.2.840.10008.1.2.1	SCU	None
Digital Mammography X-Ray Image Storage - For Processing	1.2.840.10008.5.1.4.1.1.1.2.1	Explicit VR Big Endian	1.2.840.10008.1.2.2	SCU	None
Nuclear Medicine Image Storage	1.2.840.10008.5.1.4.1.1.2.0	Implicit VR Little Endian	1.2.840.10008.1.2	SCU	None
Nuclear Medicine Image Storage	1.2.840.10008.5.1.4.1.1.2.0	Explicit VR Little Endian	1.2.840.10008.1.2.1	SCU	None
Nuclear Medicine Image Storage	1.2.840.10008.5.1.4.1.1.2.0	Explicit VR Big Endian	1.2.840.10008.1.2.2	SCU	None
Standalone Curve Storage	1.2.840.10008.5.1.4.1.1.9	Implicit VR Little Endian	1.2.840.10008.1.2	SCU	None
Standalone Curve Storage	1.2.840.10008.5.1.4.1.1.9	Explicit VR Little Endian	1.2.840.10008.1.2.1	SCU	None
Standalone Curve Storage	1.2.840.10008.5.1.4.1.1.9	Explicit VR Big Endian	1.2.840.10008.1.2.2	SCU	None
Positron Emission Tomography Image Storage	1.2.840.10008.5.1.4.1.1.1.28	Implicit VR Little Endian	1.2.840.10008.1.2	SCU	None
Positron Emission Tomography Image Storage	1.2.840.10008.5.1.4.1.1.1.28	Explicit VR Little Endian	1.2.840.10008.1.2.1	SCU	None
Positron Emission	1.2.840.10008.5.1.4.1.1.1	Explicit VR Big Endian	1.2.840.10008.1.2.2	SCU	None

Tomography Image Storage	28				
Standalone PET Curve Storage	1.2.840.10008.5.1.4.1.1.1.29	Implicit VR Little Endian	1.2.840.10008.1.2	SCU	None
Standalone PET Curve Storage	1.2.840.10008.5.1.4.1.1.1.29	Explicit VR Little Endian	1.2.840.10008.1.2.1	SCU	None
Standalone PET Curve Storage	1.2.840.10008.5.1.4.1.1.1.29	Explicit VR Big Endian	1.2.840.10008.1.2.2	SCU	None
RT Image Information Storage	1.2.840.10008.5.1.4.1.1.4.81.1	Implicit VR Little Endian	1.2.840.10008.1.2	SCU	None
RT Image Information Storage	1.2.840.10008.5.1.4.1.1.4.81.1	Explicit VR Little Endian	1.2.840.10008.1.2.1	SCU	None
RT Image Information Storage	1.2.840.10008.5.1.4.1.1.4.81.1	Explicit VR Big Endian	1.2.840.10008.1.2.2	SCU	None
RT Structure Set Information Storage	1.2.840.10008.5.1.4.1.1.4.81.3	Implicit VR Little Endian	1.2.840.10008.1.2	SCU	None
RT Structure Set Information Storage	1.2.840.10008.5.1.4.1.1.4.81.3	Explicit VR Little Endian	1.2.840.10008.1.2.1	SCU	None
RT Structure Set Information Storage	1.2.840.10008.5.1.4.1.1.4.81.3	Explicit VR Big Endian	1.2.840.10008.1.2.2	SCU	None
RT Plan Information Storage	1.2.840.10008.5.1.4.1.1.4.81.5	Implicit VR Little Endian	1.2.840.10008.1.2	SCU	None
RT Plan Information Storage	1.2.840.10008.5.1.4.1.1.4.81.5	Explicit VR Little Endian	1.2.840.10008.1.2.1	SCU	None
RT Plan Information Storage	1.2.840.10008.5.1.4.1.1.4.81.5	Explicit VR Big Endian	1.2.840.10008.1.2.2	SCU	None
GE Private DICOM RT Plan	1.2.840.113619.4.5.249	Implicit VR Little Endian	1.2.840.10008.1.2	SCU	None
GE Private DICOM RT Plan	1.2.840.113619.4.5.249	Explicit VR Little Endian	1.2.840.10008.1.2.1	SCU	None
GE Private DICOM RT Plan	1.2.840.113619.4.5.249	Explicit VR Big Endian	1.2.840.10008.1.2.2	SCU	None
NM Genie Private Data	1.2.840.113619.4.27	Implicit VR Little Endian	1.2.840.10008.1.2	SCU	None
NM Genie Private Data	1.2.840.113619.4.27	Explicit VR Little Endian	1.2.840.10008.1.2.1	SCU	None
NM Genie Private Data	1.2.840.113619.4.27	Explicit VR Big Endian	1.2.840.10008.1.2.2	SCU	None
PET Advance Private Data	1.2.840.113619.4.30	Implicit VR Little Endian	1.2.840.10008.1.2	SCU	None
PET Advance Private Data	1.2.840.113619.4.30	Explicit VR Little Endian	1.2.840.10008.1.2.1	SCU	None
PET Advance Private Data	1.2.840.113619.4.30	Explicit VR Big Endian	1.2.840.10008.1.2.2	SCU	None
GE Private DICOM 3D Object	1.2.840.113619.4.26	Implicit VR Little Endian	1.2.840.10008.1.2	SCU	None
GE Private DICOM 3D Object	1.2.840.113619.4.26	Explicit VR Little Endian	1.2.840.10008.1.2.1	SCU	None

GE Private DICOM 3D Object	1.2.840.113619.4.26	Explicit VR Big Endian	1.2.840.10008.1.2.2	SCU	None
Ultrasound Image Storage	1.2.840.10008.5.1.4.1.1.6.1	Implicit VR Little Endian	1.2.840.10008.1.2	SCU	None
Ultrasound Image Storage	1.2.840.10008.5.1.4.1.1.6.1	Explicit VR Little Endian	1.2.840.10008.1.2.1	SCU	None
Ultrasound Image Storage	1.2.840.10008.5.1.4.1.1.6.1	Explicit VR Big Endian	1.2.840.10008.1.2.2	SCU	None
Ultrasound Multi-frame Image Storage	1.2.840.10008.5.1.4.1.1.3.1	Implicit VR Little Endian	1.2.840.10008.1.2	SCU	None
Ultrasound Multi-frame Image Storage	1.2.840.10008.5.1.4.1.1.3.1	Explicit VR Little Endian	1.2.840.10008.1.2.1	SCU	None
Ultrasound Multi-frame Image Storage	1.2.840.10008.5.1.4.1.1.3.1	Explicit VR Big Endian	1.2.840.10008.1.2.2	SCU	None
Ultrasound Image Storage (Retired)	1.2.840.10008.5.1.4.1.1.6	Implicit VR Little Endian	1.2.840.10008.1.2	SCU	None
Ultrasound Image Storage (Retired)	1.2.840.10008.5.1.4.1.1.6	Explicit VR Little Endian	1.2.840.10008.1.2.1	SCU	None
Ultrasound Image Storage (Retired)	1.2.840.10008.5.1.4.1.1.6	Explicit VR Big Endian	1.2.840.10008.1.2.2	SCU	None
Ultrasound Image Storage	1.2.840.10008.5.1.4.1.1.6.1	Implicit VR Little Endian	1.2.840.10008.1.2	SCU	None
Ultrasound Image Storage	1.2.840.10008.5.1.4.1.1.6.1	Explicit VR Little Endian	1.2.840.10008.1.2.1	SCU	None
Ultrasound Image Storage	1.2.840.10008.5.1.4.1.1.6.1	Explicit VR Big Endian	1.2.840.10008.1.2.2	SCU	None
Basic Text SR	1.2.840.10008.5.1.4.1.1.8.8.11	Implicit VR Little Endian	1.2.840.10008.1.2	SCU	None
Basic Text SR	1.2.840.10008.5.1.4.1.1.8.8.11	Explicit VR Little Endian	1.2.840.10008.1.2.1	SCU	None
Basic Text SR	1.2.840.10008.5.1.4.1.1.8.8.11	Explicit VR Big Endian	1.2.840.10008.1.2.2	SCU	None
Enhanced SR	1.2.840.10008.5.1.4.1.1.8.8.22	Implicit VR Little Endian	1.2.840.10008.1.2	SCU	None
Enhanced SR	1.2.840.10008.5.1.4.1.1.8.8.22	Explicit VR Little Endian	1.2.840.10008.1.2.1	SCU	None
Enhanced SR	1.2.840.10008.5.1.4.1.1.8.8.22	Explicit VR Big Endian	1.2.840.10008.1.2.2	SCU	None
Comprehensive SR	1.2.840.10008.5.1.4.1.1.8.8.33	Implicit VR Little Endian	1.2.840.10008.1.2	SCU	None
Comprehensive SR	1.2.840.10008.5.1.4.1.1.8.8.33	Explicit VR Little Endian	1.2.840.10008.1.2.1	SCU	None
Comprehensive SR	1.2.840.10008.5.1.4.1.1.8.8.33	Explicit VR Big Endian	1.2.840.10008.1.2.2	SCU	None
Mammography CAD SR	1.2.840.10008.5.1.4.1.1.8.8.50	Implicit VR Little Endian	1.2.840.10008.1.2	SCU	None

Mammography CAD SR	1.2.840.10008.5.1.4.1.1.8 8.50	Explicit VR Little Endian	1.2.840.10008.1.2.1	SCU	None
Mammography CAD SR	1.2.840.10008.5.1.4.1.1.8 8.50	Explicit VR Big Endian	1.2.840.10008.1.2.2	SCU	None

2.3.1.1.5.3.1 SOP Specific DICOM Conformance Statement for Image Storage SOP Classes

This implementation can perform multiple C-STORE operations over a single association.

Upon receiving a C-STORE confirmation containing a successful status, this implementation will perform the next C-STORE operation. The association will be maintained if possible.

Upon receiving a C-STORE confirmation containing a Refused status, this implementation will terminate the association.

Upon receiving a C-STORE confirmation containing any status that is not Success or Refused, this implementation will consider the current request to be a failure and will terminate the association except if the C-STORE is invoked from a C-MOVE SCP. In this case it will continue to attempt to send the remaining images in the request on the same association.

Each C-STORE operation supports an “Association Timer”. This timer starts when the association request is sent and stops when the association is established. Default time-out is 30 seconds.

Each C-STORE operation supports an “Operation Inactivity Timer”. This timer starts when a C-STORE request is emitted and is reset each time a C-STORE response has been received, or when subsequent C-STORE are received. Default time-out is 180 seconds.

If any of the two timers mentioned above expires, the connection is aborted and the operation is considered as failed.

2.3.1.1.6 Real-World Activity: Manual Query

2.3.1.1.6.1 Associated Real-World Activity

The operator queries a Remote database by clicking on the icon representing the DICOM Remote AE. A new BROWSER (known as the REMOTE BROWSER) appears on the screen(s) upon successful query.

The “*Query*” operation will cause the DICOM Server AE to initiate an association to the selected Remote AE. Once a list of Patient/Study/Series/Image is retrieved, the operator can invoke the “*Retrieve*” operation by choosing “*Get Patient*” or “*Get Exam*” or “*Get Series*” or “*Get Image*” from the displayed REMOTE BROWSER (drag on drop the selection on the icon representing the Advantage Workstation 4.2 or click on the “*Get*” icon).

Note: The SCU will cancel the C-FIND by issuing a C-FIND-CANCEL request after the reception of a certain number of patients or studies. This number is configurable by the GE Field Engineer and set by default to 500.

Note: The Remote Patient List can be configured to display the studies of the Remote DICOM AE either one line per patient or one line per study.

2.3.1.1.6.2 Association Initiation Policy

The DICOM SERVER AE initiates a new association for querying Patient Folders (or Studies/Series/Images) on a remote DICOM AE. This association corresponds to one Real World Activity.

2.3.1.1.6.3 Proposed Presentation Context Table

Presentation Context Table - Proposed					
Abstract Syntax		Transfer Syntax		Role	Extended Negotiation
Name	UID	Name List	UID List		
Study Root Query/Retrieve Information Model - FIND	1.2.840.10008.5.1.4.1.2.2.1	Implicit VR Little Endian	1.2.840.10008.1.2	SCU	None
Study Root Query/Retrieve Information Model - FIND	1.2.840.10008.5.1.4.1.2.2.1	Explicit VR Little Endian	1.2.840.10008.1.2.1	SCU	None
Study Root Query/Retrieve Information Model - FIND	1.2.840.10008.5.1.4.1.2.2.1	Explicit VR Big Endian	1.2.840.10008.1.2.2	SCU	None

2.3.1.1.6.3.1 SOP Specific DICOM Conformance Statement for C-FIND-SCU

The C-FIND SCU will only perform hierarchical query (No extended negotiation supported)

Each C-FIND SCU supports an “Association Timer” and an “Operation Inactivity Timer”. These timers are defaulted to 30 and 90 seconds.

The DICOM SERVER AE will parse each matching C-FIND-RSP reply and will abort the association if an entry does not contain a valid dataset.

Following table shows the various fields that are requested at the Study level of the C-FIND request when building the list of patients.

Description	Tag	Type	Value
Study Date	0008,0020	R	Study dates (current filter)
Study Time	0008,0030	R	Study times (current filter)
Accession Number	0008,0050	R	Zero length
Patient’s Name	0010,0010	R	Patient’s name (current filter)
Patient ID	0010,0020	R	Patient ID (current filter)
Study ID	0020,0010	R	Zero length
Study Instance UID	0020,000D	U	Zero length
Modalities in Study	0008,0061	O	Requested modalities (current filter)
Patient’s Birth Date	0010,0030	O	Zero length
Patient’s Sex	0010,0040	O	Zero length

Following table shows the various fields that are requested at the Study level of the C-FIND request when building the list of studies of a given patient when the Remote Patient List is configured to display one line per patient for the remote DICOM AE.

Description	Tag	Type	Value
Study Date	0008,0020	R	Zero length
Study Time	0008,0030	R	Zero length
Accession Number	0008,0050	R	Zero length
Patient’s Name	0010,0010	R	Patient’s Name

Description	Tag	Type	Value
Patient ID	0010,0020	R	Patient ID
Study ID	0020,0010	R	Zero length
Study Instance UID	0020,000D	U	Zero length
Modalities in Study	0008,0061	O	Zero length
Referring Physician's Name	0008,0090	O	Zero length
Study Description	0008,1030	O	Zero length

Following table shows the various fields that are requested at the Study level of the C-FIND request when building the list of studies of a given patient when the Remote Patient List is configured to display one line per study for the remote DICOM AE.

Description	Tag	Type	Value
Study Date	0008,0020	R	Zero length
Study Time	0008,0030	R	Zero length
Accession Number	0008,0050	R	Zero length
Patient's Name	0010,0010	R	Zero length
Patient ID	0010,0020	R	Zero length
Study ID	0020,0010	R	Zero length
Study Instance UID	0020,000D	U	Study Instance UID
Modalities in Study	0008,0061	O	Zero length
Referring Physician's Name	0008,0090	O	Zero length
Study Description	0008,1030	O	Zero length

Following table shows the various fields that are requested at the Series level of the C-FIND request when building the list of series of a given study.

Description	Tag	Type	Value
Series Number	0008,0011	R	Zero length
Modality	0008,0060	R	Zero length
Series Instance UID	0020,000E	U	Zero length
Series Description	0008,103E	O	Zero length

Following table shows the various fields that are requested at the Image level of the C-FIND request when building the list of instances of a given series. The list of requested fields depends on the value returned for the Modality (0008,0060) in the C-FIND-RSP response at series level given by the remote AE.

Description	Tag	Type	Value	Modality
Instance Number	0020,0013	R	Zero length	All
SOP Instance UID	0008,0018	U	Zero length	All
SOP Class UID	0008,0016	O	Zero length	All
Content Date	0008,0023	O	Zero length	All
Content Time	0008,0033	O	Zero length	All
Operator's Name	0008,1070	O	Zero length	RTIMAGE RTPLAN RTSTRUCT
Recommended Display Frame Rate	0008,2144	O	Zero length	RF
Body Part Examined	0018,0015	O	Zero length	DX MG
Sequence Variant	0018,0021	O	Zero length	MR
Slice Thickness	0018,0050	O	Zero length	CT MR

Description	Tag	Type	Value	Modality
Repetition Time	0018,0080	O	Zero length	MR
Echo Time	0018,0081	O	Zero length	MR
Inversion Time	0018,0082	O	Zero length	MR
Echo Number(s)	0018,0086	O	Zero length	MR
Spacing Between Slices	0018,0088	O	Zero length	MR
Data Collection Diameter	0018,0090	O	Zero length	CT
Trigger Time	0018,1060	O	Zero length	MR
Reconstruction Diameter	0018,1100	O	Zero length	CT MR
Gantry Detector Tilt	0018,1120	O	Zero length	CT
Radiation Setting	0018,1155	O	Zero length	RF
Convolution Kernel	0018,1210	O	Zero length	CT
Flip Angle	0018,1314	O	Zero length	MR
Image Orientation (Patient)	0020,0037	O	Zero length	CT
Image Laterality	0020,0062	O	Zero length	DX MG
Slice Location	0020,1041	O	Zero length	CT MR
Image Comments	0020,4000	O	Zero length	CR
Number of Frames	0028,0008	O	Zero length	RF NM PT US XA
Rows	0028,0010	O	Zero length	CT MR RF NM PT US XA
Columns	0028,0011	O	Zero length	CT MR RF NM PT US XA
Completion Flag	0040,A491	O	Zero length	SR
Verification Flag	0040,A493	O	Zero length	SR
RT Image Label	3002,0002	O	Zero length	RTIMAGE
RT Image Name	3002,0003	O	Zero length	RTIMAGE
Structure Set Label	3006,0002	O	Zero length	RTSTRUCT
Structure Set Name	3006,0004	O	Zero length	RTSTRUCT
RT Plan Label	300A,0002	O	Zero length	RTPLAN
RT Plan Name	300A,0003	O	Zero length	RTPLAN

2.3.1.1.7 Real-World Activity: Manual Retrieve

2.3.1.1.7.1 Associated Real-World Activity

The operator then has to perform the Real-World activity “Query” to get a list of Patient/Study/Series/Image. Once the list of Patient/Study/Series/Image is retrieved, the operator can invoke the “Retrieve” operation by choosing “Get Patient” or “Get Exam” or

“Get Series” or “Get Image” from the displayed REMOTE BROWSER (drag on drop the selection on the icon representing the Advantage Workstation 4.2 or click on the “Get” icon).

2.3.1.1.7.2 Association Initiation Policy

The DICOM SERVER AE initiates a new association for retrieving Patient Folders (or Studies/Series/Images) on a remote DICOM AE. This association corresponds to one Real World Activity.

2.3.1.1.7.3 Proposed Presentation Context Table

When the remote DICOM AE is declared as a Patient Root Provider and the invoked operation is “Get Patient”, the presentation context shown in following table is proposed.

Presentation Context Table - Proposed					
Abstract Syntax		Transfer Syntax		Role	Extended Negotiation
Name	UID	Name List	UID List		
Patient Root Query/Retrieve Information Model - MOVE	1.2.840.10008.5.1.4.1.2.1.2	Implicit VR Little Endian	1.2.840.10008.1.2	SCU	None
Patient Root Query/Retrieve Information Model – MOVE	1.2.840.10008.5.1.4.1.2.1.2	Explicit VR Little Endian	1.2.840.10008.1.2.1	SCU	None
Patient Root Query/Retrieve Information Model – MOVE	1.2.840.10008.5.1.4.1.2.1.2	Explicit VR Big Endian	1.2.840.10008.1.2.2	SCU	None

When the remote DICOM AE is declared as a Study Root Provider or the invoked operation is “Get Study” or “Get Series” or “Get Image”, the presentation context shown in following table is proposed.

Presentation Context Table - Proposed					
Abstract Syntax		Transfer Syntax		Role	Extended Negotiation
Name	UID	Name List	UID List		
Study Root Query/Retrieve Information Model - MOVE	1.2.840.10008.5.1.4.1.2.2.2	Implicit VR Little Endian	1.2.840.10008.1.2	SCU	None
Study Root Query/Retrieve Information Model - MOVE	1.2.840.10008.5.1.4.1.2.2.2	Explicit VR Little Endian	1.2.840.10008.1.2.1	SCU	None
Study Root Query/Retrieve Information Model - MOVE	1.2.840.10008.5.1.4.1.2.2.2	Explicit VR Big Endian	1.2.840.10008.1.2.2	SCU	None

2.3.1.1.7.3.1 SOP Specific DICOM Conformance Statement for the Patient Root Query/Retrieve Information Model - MOVE, Study Root Query/Retrieve Information Model - MOVE SOP Classes

When the operator starts a *Move* operation at any level (Patient, Study, Series, Image) the DICOM Server AE will initiate a C-MOVE-RQ request to the Remote AE with the DICOM Server AE as the Destination AE. The Storage SCP (“Receive Images from Remote AE”) will handle the incoming images.

Each C-MOVE SCU supports an “Association Timer” and an “Operation Inactivity Timer”. These timers are defaulted to 30 and 600 seconds.

If the C-MOVE SCU receives a status different from success (0x0000) or pending (0xFF00) during the association, the DICOM Server AE will release the association.

When receiving a Cancel request response (0xFE00), the DICOM Server AE will release the association.

2.3.1.1.8 Real-World Activity: Receive Images from Remote AE

This AE is indefinitely listening for associations. No operator action is required to receive an image.

2.3.1.1.8.1 Associated Real-World Activity

The Real-World Activity associated with the Receive Images operation is the storage of the images on the disk drive of the Advantage Workstation 4.2 and the declaration of the images in the database of the same station.

2.3.1.1.8.2 Association Initiation Policy

The DICOM SERVER AE refuses the association if they are too many open connections.

2.3.1.1.8.3 Presentation Context Table

Acceptable Presentation Contexts for DICOM Server AE and Real-World Activity Receive Images from Remote AE.

Presentation Context Table - Proposed					
Abstract Syntax		Transfer Syntax		Role	Extended Negotiation
Name	UID	Name List	UID List		
Computed Radiography Image Storage	1.2.840.10008.5.1.4.1.1.1	Implicit VR Little Endian	1.2.840.10008.1.2	SCP	None
Computed Radiography Image Storage	1.2.840.10008.5.1.4.1.1.1	Explicit VR Little Endian	1.2.840.10008.1.2.1	SCP	None
Computed Radiography Image Storage	1.2.840.10008.5.1.4.1.1.1	Explicit VR Big Endian	1.2.840.10008.1.2.2	SCP	None
CT Image Storage	1.2.840.10008.5.1.4.1.1.2	Implicit VR Little Endian	1.2.840.10008.1.2	SCP	None
CT Image Storage	1.2.840.10008.5.1.4.1.1.2	Explicit VR Little Endian	1.2.840.10008.1.2.1	SCP	None
CT Image Storage	1.2.840.10008.5.1.4.1.1.2	Explicit VR Big Endian	1.2.840.10008.1.2.2	SCP	None
MR Image Storage	1.2.840.10008.5.1.4.1.1.4	Implicit VR Little Endian	1.2.840.10008.1.2	SCP	None
MR Image Storage	1.2.840.10008.5.1.4.1.1.4	Explicit VR Little Endian	1.2.840.10008.1.2.1	SCP	None
MR Image Storage	1.2.840.10008.5.1.4.1.1.4	Explicit VR Big Endian	1.2.840.10008.1.2.2	SCP	None
X-Ray Angiographic Image Storage	1.2.840.10008.5.1.4.1.1.1 2.1	Implicit VR Little Endian	1.2.840.10008.1.2	SCP	None
X-Ray Angiographic Image	1.2.840.10008.5.1.4.1.1.1	Explicit VR Little	1.2.840.10008.1.2.1	SCP	None

Storage	2.1	Endian			
X-Ray Angiographic Image Storage	1.2.840.10008.5.1.4.1.1.1.2.1	Explicit VR Big Endian	1.2.840.10008.1.2.2	SCP	None
X-Ray Radiofluoroscopic Image Storage	1.2.840.10008.5.1.4.1.1.1.2.2	Implicit VR Little Endian	1.2.840.10008.1.2	SCP	None
X-Ray Radiofluoroscopic Image Storage	1.2.840.10008.5.1.4.1.1.1.2.2	Explicit VR Little Endian	1.2.840.10008.1.2.1	SCP	None
X-Ray Radiofluoroscopic Image Storage	1.2.840.10008.5.1.4.1.1.1.2.2	Explicit VR Big Endian	1.2.840.10008.1.2.2	SCP	None
Secondary Capture Image Storage	1.2.840.10008.5.1.4.1.1.7	Implicit VR Little Endian	1.2.840.10008.1.2	SCP	None
Secondary Capture Image Storage	1.2.840.10008.5.1.4.1.1.7	Explicit VR Little Endian	1.2.840.10008.1.2.1	SCP	None
Secondary Capture Image Storage	1.2.840.10008.5.1.4.1.1.7	Explicit VR Big Endian	1.2.840.10008.1.2.2	SCP	None
Digital X-Ray Image Storage - For Presentation	1.2.840.10008.5.1.4.1.1.1.1	Implicit VR Little Endian	1.2.840.10008.1.2	SCP	None
Digital X-Ray Image Storage - For Presentation	1.2.840.10008.5.1.4.1.1.1.1	Explicit VR Little Endian	1.2.840.10008.1.2.1	SCP	None
Digital X-Ray Image Storage - For Presentation	1.2.840.10008.5.1.4.1.1.1.1	Explicit VR Big Endian	1.2.840.10008.1.2.2	SCP	None
Digital X-Ray Image Storage - For Processing	1.2.840.10008.5.1.4.1.1.1.1.1	Implicit VR Little Endian	1.2.840.10008.1.2	SCP	None
Digital X-Ray Image Storage - For Processing	1.2.840.10008.5.1.4.1.1.1.1.1	Explicit VR Little Endian	1.2.840.10008.1.2.1	SCP	None
Digital X-Ray Image Storage - For Processing	1.2.840.10008.5.1.4.1.1.1.1.1	Explicit VR Big Endian	1.2.840.10008.1.2.2	SCP	None
Digital Mammography X-Ray Image Storage - For Presentation	1.2.840.10008.5.1.4.1.1.1.2	Implicit VR Little Endian	1.2.840.10008.1.2	SCP	None
Digital Mammography X-Ray Image Storage - For Presentation	1.2.840.10008.5.1.4.1.1.1.2	Explicit VR Little Endian	1.2.840.10008.1.2.1	SCP	None
Digital Mammography X-Ray Image Storage - For Presentation	1.2.840.10008.5.1.4.1.1.1.2	Explicit VR Big Endian	1.2.840.10008.1.2.2	SCP	None
Digital Mammography X-Ray Image Storage - For Processing	1.2.840.10008.5.1.4.1.1.1.2.1	Implicit VR Little Endian	1.2.840.10008.1.2	SCP	None
Digital Mammography X-Ray Image Storage - For Processing	1.2.840.10008.5.1.4.1.1.1.2.1	Explicit VR Little Endian	1.2.840.10008.1.2.1	SCP	None
Digital Mammography X-Ray Image Storage - For Processing	1.2.840.10008.5.1.4.1.1.1.2.1	Explicit VR Big Endian	1.2.840.10008.1.2.2	SCP	None

Nuclear Storage	Medicine Image	1.2.840.10008.5.1.4.1.1.20	Implicit VR Little Endian	1.2.840.10008.1.2	SCP	None
Nuclear Storage	Medicine Image	1.2.840.10008.5.1.4.1.1.20	Explicit VR Little Endian	1.2.840.10008.1.2.1	SCP	None
Nuclear Storage	Medicine Image	1.2.840.10008.5.1.4.1.1.20	Explicit VR Big Endian	1.2.840.10008.1.2.2	SCP	None
Standalone Curve Storage		1.2.840.10008.5.1.4.1.1.9	Implicit VR Little Endian	1.2.840.10008.1.2	SCP	None
Standalone Curve Storage		1.2.840.10008.5.1.4.1.1.9	Explicit VR Little Endian	1.2.840.10008.1.2.1	SCP	None
Standalone Curve Storage		1.2.840.10008.5.1.4.1.1.9	Explicit VR Big Endian	1.2.840.10008.1.2.2	SCP	None
Positron Tomography Image Storage	Emission	1.2.840.10008.5.1.4.1.1.128	Implicit VR Little Endian	1.2.840.10008.1.2	SCP	None
Positron Tomography Image Storage	Emission	1.2.840.10008.5.1.4.1.1.128	Explicit VR Little Endian	1.2.840.10008.1.2.1	SCP	None
Positron Tomography Image Storage	Emission	1.2.840.10008.5.1.4.1.1.128	Explicit VR Big Endian	1.2.840.10008.1.2.2	SCP	None
Standalone Storage	PET Curve	1.2.840.10008.5.1.4.1.1.129	Implicit VR Little Endian	1.2.840.10008.1.2	SCP	None
Standalone Storage	PET Curve	1.2.840.10008.5.1.4.1.1.129	Explicit VR Little Endian	1.2.840.10008.1.2.1	SCP	None
Standalone Storage	PET Curve	1.2.840.10008.5.1.4.1.1.129	Explicit VR Big Endian	1.2.840.10008.1.2.2	SCP	None
RT Image Information Storage		1.2.840.10008.5.1.4.1.1.481.1	Implicit VR Little Endian	1.2.840.10008.1.2	SCP	None
RT Image Information Storage		1.2.840.10008.5.1.4.1.1.481.1	Explicit VR Little Endian	1.2.840.10008.1.2.1	SCP	None
RT Image Information Storage		1.2.840.10008.5.1.4.1.1.481.1	Explicit VR Big Endian	1.2.840.10008.1.2.2	SCP	None
RT Structure Set Information Storage		1.2.840.10008.5.1.4.1.1.481.3	Implicit VR Little Endian	1.2.840.10008.1.2	SCP	None
RT Structure Set Information Storage		1.2.840.10008.5.1.4.1.1.481.3	Explicit VR Little Endian	1.2.840.10008.1.2.1	SCP	None
RT Structure Set Information Storage		1.2.840.10008.5.1.4.1.1.481.3	Explicit VR Big Endian	1.2.840.10008.1.2.2	SCP	None
RT Plan Information Storage		1.2.840.10008.5.1.4.1.1.481.5	Implicit VR Little Endian	1.2.840.10008.1.2	SCP	None
RT Plan Information Storage		1.2.840.10008.5.1.4.1.1.481.5	Explicit VR Little Endian	1.2.840.10008.1.2.1	SCP	None
RT Plan Information Storage		1.2.840.10008.5.1.4.1.1.481.5	Explicit VR Big Endian	1.2.840.10008.1.2.2	SCP	None
GE Private DICOM RT Plan		1.2.840.113619.4.5.249	Implicit VR Little Endian	1.2.840.10008.1.2	SCP	None

GE Private DICOM RT Plan	1.2.840.113619.4.5.249	Explicit VR Little Endian	1.2.840.10008.1.2.1	SCP	None
GE Private DICOM RT Plan	1.2.840.113619.4.5.249	Explicit VR Big Endian	1.2.840.10008.1.2.2	SCP	None
NM Genie Private Data	1.2.840.113619.4.27	Implicit VR Little Endian	1.2.840.10008.1.2	SCP	None
NM Genie Private Data	1.2.840.113619.4.27	Explicit VR Little Endian	1.2.840.10008.1.2.1	SCP	None
NM Genie Private Data	1.2.840.113619.4.27	Explicit VR Big Endian	1.2.840.10008.1.2.2	SCP	None
PET Advance Private Data	1.2.840.113619.4.30	Implicit VR Little Endian	1.2.840.10008.1.2	SCP	None
PET Advance Private Data	1.2.840.113619.4.30	Explicit VR Little Endian	1.2.840.10008.1.2.1	SCP	None
PET Advance Private Data	1.2.840.113619.4.30	Explicit VR Big Endian	1.2.840.10008.1.2.2	SCP	None
GE Private DICOM 3D Object	1.2.840.113619.4.26	Implicit VR Little Endian	1.2.840.10008.1.2	SCP	None
GE Private DICOM 3D Object	1.2.840.113619.4.26	Explicit VR Little Endian	1.2.840.10008.1.2.1	SCP	None
GE Private DICOM 3D Object	1.2.840.113619.4.26	Explicit VR Big Endian	1.2.840.10008.1.2.2	SCP	None
Ultrasound Image Storage	1.2.840.10008.5.1.4.1.1.6.1	Implicit VR Little Endian	1.2.840.10008.1.2	SCP	None
Ultrasound Image Storage	1.2.840.10008.5.1.4.1.1.6.1	Explicit VR Little Endian	1.2.840.10008.1.2.1	SCP	None
Ultrasound Image Storage	1.2.840.10008.5.1.4.1.1.6.1	Explicit VR Big Endian	1.2.840.10008.1.2.2	SCP	None
Ultrasound Multi-frame Image Storage	1.2.840.10008.5.1.4.1.1.3.1	Implicit VR Little Endian	1.2.840.10008.1.2	SCP	None
Ultrasound Multi-frame Image Storage	1.2.840.10008.5.1.4.1.1.3.1	Explicit VR Little Endian	1.2.840.10008.1.2.1	SCP	None
Ultrasound Multi-frame Image Storage	1.2.840.10008.5.1.4.1.1.3.1	Explicit VR Big Endian	1.2.840.10008.1.2.2	SCP	None
Ultrasound Image Storage (Retired)	1.2.840.10008.5.1.4.1.1.6	Implicit VR Little Endian	1.2.840.10008.1.2	SCP	None
Ultrasound Image Storage (Retired)	1.2.840.10008.5.1.4.1.1.6	Explicit VR Little Endian	1.2.840.10008.1.2.1	SCP	None
Ultrasound Image Storage (Retired)	1.2.840.10008.5.1.4.1.1.6	Explicit VR Big Endian	1.2.840.10008.1.2.2	SCP	None
Ultrasound Image Storage	1.2.840.10008.5.1.4.1.1.6.1	Implicit VR Little Endian	1.2.840.10008.1.2	SCP	None
Ultrasound Image Storage	1.2.840.10008.5.1.4.1.1.6.1	Explicit VR Little Endian	1.2.840.10008.1.2.1	SCP	None
Ultrasound Image Storage	1.2.840.10008.5.1.4.1.1.6.1	Explicit VR Big Endian	1.2.840.10008.1.2.2	SCP	None
Basic Text SR	1.2.840.10008.5.1.4.1.1.8.8.11	Implicit VR Little Endian	1.2.840.10008.1.2	SCP	None

Basic Text SR	1.2.840.10008.5.1.4.1.1.8 8.11	Explicit VR Little Endian	1.2.840.10008.1.2.1	SCP	None
Basic Text SR	1.2.840.10008.5.1.4.1.1.8 8.11	Explicit VR Big Endian	1.2.840.10008.1.2.2	SCP	None
Enhanced SR	1.2.840.10008.5.1.4.1.1.8 8.22	Implicit VR Little Endian	1.2.840.10008.1.2	SCP	None
Enhanced SR	1.2.840.10008.5.1.4.1.1.8 8.22	Explicit VR Little Endian	1.2.840.10008.1.2.1	SCP	None
Enhanced SR	1.2.840.10008.5.1.4.1.1.8 8.22	Explicit VR Big Endian	1.2.840.10008.1.2.2	SCP	None
Comprehensive SR	1.2.840.10008.5.1.4.1.1.8 8.33	Implicit VR Little Endian	1.2.840.10008.1.2	SCP	None
Comprehensive SR	1.2.840.10008.5.1.4.1.1.8 8.33	Explicit VR Little Endian	1.2.840.10008.1.2.1	SCP	None
Comprehensive SR	1.2.840.10008.5.1.4.1.1.8 8.33	Explicit VR Big Endian	1.2.840.10008.1.2.2	SCP	None
Mammography CAD SR	1.2.840.10008.5.1.4.1.1.8 8.50	Implicit VR Little Endian	1.2.840.10008.1.2	SCP	None
Mammography CAD SR	1.2.840.10008.5.1.4.1.1.8 8.50	Explicit VR Little Endian	1.2.840.10008.1.2.1	SCP	None
Mammography CAD SR	1.2.840.10008.5.1.4.1.1.8 8.50	Explicit VR Big Endian	1.2.840.10008.1.2.2	SCP	None

Note: The SCP does not have a default acceptance policy if more than one acceptable transfer syntax is proposed by the SCU. It is the responsibility of the SCU to make a selection from more than one presentation context accepted.

2.3.1.1.8.3.1 SOP Specific Conformance to Storage SOP Classes

Private elements are not discarded from the image when receiving images containing non-GE private data elements.

Each C-STORE SCP operation supports an "Operation Inactivity Timer" with time out values of 605 seconds.

Image Reception phase:

In case of failure, the image will not be installed in the local database and the DICOM Server AE will return one of the following status codes for the C-STORE:

- C000 (Cannot understand) indicates that the processing failed during the reception of the image.
- A700 (No Resources) Indicates that probably there was not enough disk space to store the image. The user should attempt recovery by removing some images from the Advantage Workstation 4.2.

In the event of a successful C-STORE operation, the image has successfully been written to disk, but may not have been declared in the database. Indeed, **the successful status code is returned before the image declaration since it is assumed that if the image is written on**

the disk it has no reason not to be declared. Thus, if the declaration failed the association is aborted.

The image will then be accessed in the same manner as any other image by the applications on the Advantage Workstation 4.2.

Images may be deleted when instructed to do so by the user. The users of the Advantage Workstation 4.2 determine the duration of the storage of the image.

When a C-STORE operation returns Error, a message will appear in the browser informing the user of a failure.

Image Declaration phase:

- Note:** To be displayed in the Viewer an image containing overlay planes defined in the high bits of the pixels (7FE0,0010) must fulfill the following conditions:
- the pixels are unsigned integers (0028,0103),
 - the pixel allocated bits is equal to 16 (0028,0100)
 - the overlay sizes, (60xx,0010) and (60xx,0011), are equal to the image size, (0028,0010) and (0028,0011)
 - the overlay origins (60xx,0050) are equal to x=1, y=1,
 - if the pixels have the same bit ordering than the image (0002,0010) or the overlay allocated bits (60xx,0100) are equal to the pixel allocated bits (0028,0100) i.e. 16, see above
- Note:** To be displayed in the Viewer an image containing overlay planes defined in the header fields (60xx, 3000) must fulfill the following conditions:
- the file contains a single frame (0028,0008),
 - the overlay origins (60xx,0050) are equal to x=1, y=1,
 - the sizes of all overlays, (60xx,0010) and (60xx,0011), are equal to the image size, (0028,0010) and (0028,0011)
- Note:** Only the 8 first overlay planes can be displayed in the Viewer.
- Note:** The Viewer does not support multi-frame overlays ((60xx, 0015) and (60xx, 0051))
- Note:** Images that have the fields Patient's Name (0010,0010) and Patient ID (0010,0020) empty are accepted into the local database.
- Note:** If the pixel size is available measurement algorithm uses:
- either because defined in the image header
 - (0008,2111) for combined images
 - (0018,1164) or (0028,0030) if the first one is undefined, for CR images

- (0018,1164) for Senovision, DX and MG images
- (0028,0030) for other images
- (no header field is used for XA and RF images)
- either because the end user has calibrated the image, measurements shall be indicated in millimeters for distance or square millimeters for areas. Otherwise, they shall be indicated in pixels or square pixels.

Note: Standalone Overlay Storage SOP Class instances will be formatted into Secondary Capture SOP Class instances when installed on the Advantage Workstation 4.2.

Note: All kind of color images are stored by the Advantage Workstation 4.2, but only secondary captures which have a photometric interpretation (0028,0004) equal to “MONOCHROME 1”, “MONOCHROME 2”, “PALETTE COLOR” or “RGB” with planar configuration (0028,0006) equal to 0 (color by pixel) or 1 (color by plane) are displayable.

Note: Modality LUT will be ignored by the Advantage Workstation 4.2.

Note: Images with non-square pixels are not handled correctly by the AW4.2.

Note: No optional data elements (Type 3) or filled data elements (Type 2) are required to be declared on the Advantage Workstation 4.2.

Note: When 2 images have the same DICOM Instance UID, the latest image received will overwrite the first received image if it has the same patient/study/series identifiers. It will be refused otherwise.

2.3.1.1.8.4 Presentation Context Acceptance Criterion

Only known SOP Classes are accepted.

2.3.1.1.8.5 Transfer Syntax Selection Policies

The transfer syntax selection policy is the following:

- Only the following transfer syntax are accepted: Implicit VR Little Endian (1.2.840.10008.1.2), Explicit VR Little Endian (1.2.840.10008.1.2.1), Explicit VR Big Endian (1.2.840.10008.1.2.2)
- Among all the remaining proposed transfer syntaxes, the explicit transfer syntaxes are chosen first.
- Among all the remaining proposed transfer syntaxes, the little endian transfer syntaxes are chosen first.

2.3.1.1.9 Real-World Activity: Query Request from Remote AE

This AE is indefinitely listening for associations. No operator action is required to respond to a *query* request.

2.3.1.1.9.1 Associated Real-World Activity

The Real-World Activity associated with the query request is to search the local database for entries that match the request and send a C-FIND response message with a status of "pending" for each matching entry and send a C-FIND response message with a status of "success" after the last "pending" response.

If the C-FIND SCP receives a C-FIND-CANCEL request, it sends a C-FIND response message with a status of "cancel".

2.3.1.1.9.2 Association Initiation Policy

The DICOM SERVER AE refuses the association if they are too many opened connections.

2.3.1.1.9.3 Presentation Context Table

Acceptable Presentation Contexts for DICOM Server AE and Real-World Activity Query Request.

Presentation Context Table					
Abstract Syntax		Transfer Syntax		Role	Extended Negotiation
Name	UID	Name List	UID List		
Study Root Query/Retrieve Information Model - FIND	1.2.840.10008.5.1.4.1.2.2.1	Implicit VR Little Endian	1.2.840.10008.1.2	SCP	None
Study Root Query/Retrieve Information Model - FIND	1.2.840.10008.5.1.4.1.2.2.1	Explicit VR Little Endian	1.2.840.10008.1.2.1	SCP	None
Study Root Query/Retrieve Information Model - FIND	1.2.840.10008.5.1.4.1.2.2.1	Explicit VR Big Endian	1.2.840.10008.1.2.2	SCP	None

2.3.1.1.9.3.1 SOP Specific Conformance to C-FIND SCP

Each C-FIND SCP operation supports an "Operation Inactivity Timer" with a time out value of 605 seconds. This timer corresponds to the number of seconds to wait when data between TCP/IP packets are transferred.

All Required (R) and Unique (U) study, series, and image level keys for the Study-Root Query/Retrieve information model are supported. Some optional (O) keys are also supported as described in the following tables.

Following is the supported study level keys:

Description	Tag	Type	Usage
Study Date	(0008,0020)	R	Matched
Study Time	(0008,0030)	R	Matched
Accession Number	(0008,0050)	R	Matched
Patient's Name	(0010,0010)	R	Matched
Patient ID	(0010,0020)	R	Matched
Study ID	(0020,0010)	R	Matched
Study Instance UID	(0020,000D)	U	Matched
Modalities In Study	(0008,0061)	O	Matched
Referring Physicians Name	(0008,0090)	O	Matched

Study Description	(0008,1030)	O	Returned
Patients Sex	(0010,0040)	O	Returned

Following is the supported series level keys:

Description	Tag	Type	Usage
Modality	(0008,0060)	R	Matched
Series Number	(0020,0011)	R	Matched
Series Instance UID	(0020,000E)	U	Matched
Series Description	(0008,103E)	O	Returned

Following is the supported image level keys:

Description	Tag	Type	Usage	Modality
SOP Class UID	(0008,0016)	R	Matched	All
Instance Number	(0020,0013)	R	Matched	All
SOP Instance UID	(0008,0018)	U	Matched	All
Image Date	(0008,0023)	O	Returned	All
Image Time	(0008,0033)	O	Returned	All
Number of Frames	(0028,0008)	O	Returned	RF NM PT US XA
Completion Flag	(0040,A491)	O	Matched	SR
Verification Flag	(0040, A493)	O	Matched	SR

Only keys with Usage type *Matched* will be matched against values in the database.

Values in keys of type *Returned* will be ignored and will be filled in with data from the database.

If an optional key is requested that does not appear in any of the tables above, that key will be ignored and no corresponding element will be returned.

If the database does not have a value corresponding to any requested optional key a zero-length element will be returned.

Sequence matching is not supported.

Range matching is supported for attributes of type date and time.

Only hierarchical query is supported. Therefore, the C-FIND SCP will not perform any extended negotiation.

During the C-FIND SCP, the DICM Server AE can send the following status:

- 0xFE00 when the DICOM remote AE sent a DICOM C-FIND CANCEL request

- 0xFF00: for pending messages
- 0xFF01: for pending messages when the DICOM remote AE asked for optional key
- 0xA700 when too many connections are open at the same time.
- 0xA900 when the DICOM Server AE processes an invalid data set.
- 0xC001 when the DICOM Server AE processes an internal error or a decoding error
- 0x0000 in case of success

2.3.1.1.10 Real-World Activity: Retrieve Request From Remote AE

This AE is indefinitely listening for associations. No operator action is required to respond to a *retrieve* request.

2.3.1.1.10.1 Associated Real-World Activity

The Real-World Activity associated with the Retrieve Request is to send all images corresponding to the C-MOVE request to the destination AE through a separate association.

If the C-MOVE SCP receives a C-MOVE-CANCEL request, it closes the separate association.

2.3.1.1.10.2 Association Initiation Policy

The DICOM SERVER AE rejects the association if they are too many open connections.

The DICOM SERVER AE rejects the association if the Remote DICOM AE is not declared on the local Advantage Workstation 4.2

2.3.1.1.10.3 Presentation Context Table

Acceptable Presentation Contexts for DICOM Server AE and Real-World Activity Retrieve Request.

Presentation Context Table					
Abstract Syntax		Transfer Syntax		Role	Extended Negotiation
Name	UID	Name List	UID List		
Study Root Query/Retrieve Information Model - MOVE	1.2.840.10008.5.1.4.1.2.2.2	Implicit VR Little Endian	1.2.840.10008.1.2	SCP	None
Study Root Query/Retrieve Information Model - MOVE	1.2.840.10008.5.1.4.1.2.2.2	Explicit VR Little Endian	1.2.840.10008.1.2.1	SCP	None
Study Root Query/Retrieve Information Model - MOVE	1.2.840.10008.5.1.4.1.2.2.2	Explicit VR Big Endian	1.2.840.10008.1.2.2	SCP	None
Patient Root Query/Retrieve Information Model - MOVE	1.2.840.10008.5.1.4.1.2.1.2	Implicit VR Little Endian	1.2.840.10008.1.2	SCP	None
Patient Root Query/Retrieve Information Model - MOVE	1.2.840.10008.5.1.4.1.2.1.2	Explicit VR Little Endian	1.2.840.10008.1.2.1	SCP	None
Patient Root Query/Retrieve Information Model - MOVE	1.2.840.10008.5.1.4.1.2.1.2	Explicit VR Big Endian	1.2.840.10008.1.2.2	SCP	None

2.3.1.1.10.3.1 SOP Specific Conformance to C-MOVE SCP

The DICOM Server AE provides standard conformance to the baseline Study-root C-MOVE Service Class SCP and Patient-root C-MOVE Service Class SCP.

Each C-MOVE SCP operation supports an “Operation Inactivity Timer” with a time out value of 605 seconds. This timer corresponds to the number of seconds to wait when data between TCP/IP packets are transferred.

All images requested in a C-MOVE-RQ will be sent over a single association. A C-MOVE-RSP with a “pending” status will be returned to the requester every seven seconds.

The C-MOVE SCP will invoke C-STORE requests for the following SOP classes:

SOP Class Name	SOP Class UID
Computed Radiography Image Storage	1.2.840.10008.5.1.4.1.1.1
CT Image Storage	1.2.840.10008.5.1.4.1.1.2
MR Image Storage	1.2.840.10008.5.1.4.1.1.4
X-Ray Angiographic Image Storage	1.2.840.10008.5.1.4.1.1.12.1
X-Ray Radiofluoroscopic Image Storage	1.2.840.10008.5.1.4.1.1.12.2
Secondary Capture Image Storage	1.2.840.10008.5.1.4.1.1.7
Digital X-Ray Image Storage - For Presentation	1.2.840.10008.5.1.4.1.1.1.1
Digital X-Ray Image Storage - For Processing	1.2.840.10008.5.1.4.1.1.1.1.1
Digital Mammography X-Ray Image Storage - For Presentation	1.2.840.10008.5.1.4.1.1.1.2
Digital Mammography X-Ray Image Storage - For Processing	1.2.840.10008.5.1.4.1.1.1.2.1
Nuclear Medicine Image Storage	1.2.840.10008.5.1.4.1.1.20
Standalone Curve Storage	1.2.840.10008.5.1.4.1.1.9
Positron Emission Tomography Image Storage	1.2.840.10008.5.1.4.1.1.128
Standalone PET Curve Storage	1.2.840.10008.5.1.4.1.1.129
RT Image Information Storage	1.2.840.10008.5.1.4.1.1.481.1
RT Structure Set Information Storage	1.2.840.10008.5.1.4.1.1.481.3
RT Plan Information Storage	1.2.840.10008.5.1.4.1.1.481.5
GE Private DICOM RT Plan	1.2.840.113619.4.5.249
NM Genie Private Data	1.2.840.113619.4.27
PET Advance Private Data	1.2.840.113619.4.30

GE Private DICOM 3D Object	1.2.840.113619.4.26
Ultrasound Image Storage	1.2.840.10008.5.1.4.1.1.6.1
Ultrasound Multi-frame Image Storage	1.2.840.10008.5.1.4.1.1.3.1
Ultrasound Image Storage (Retired)	1.2.840.10008.5.1.4.1.1.6
Ultrasound Multi-frame Image Storage (Retired)	1.2.840.10008.5.1.4.1.1.3
Basic Text SR	1.2.840.10008.5.1.4.1.1.88.11
Enhanced SR	1.2.840.10008.5.1.4.1.1.88.22
Comprehensive SR	1.2.840.10008.5.1.4.1.1.88.33
Mammography CAD SR	1.2.840.10008.5.1.4.1.1.88.50

During the C-MOVE SCP, the DICM Server AE can send the following status:

- 0xFE00: (C-Move Cancel Request Received) when the C-MOVE SCU cancelled the operation
- 0xA702: when the association with the C-STORE SCP was rejected
- 0xA801: when the destination unknown
- 0xA900: when the dataset is invalid
- 0xFF00: for pending messages.
- 0xB000 when one or more failure occurred
- 0x0000 when the whole C-MOVE operation was successful

2.3.1.1.10.4 Presentation Context Acceptance Criteria

No criterion.

2.3.1.1.10.5 Transfer Syntax Selection Policy

All protocols detailed above in the tables are supported, no priority selection is given.

2.3.2 DICOM STORAGE COMMITMENT SERVER AE Specification

This Application Entity provides Standard Conformance to the following DICOM SOP Classes as an SCU:

SOP Class Name	SOP Class UID
Storage Commitment Push Model	1.2.840.10008.1.20.1

2.3.2.1 Association Establishment Policies

2.3.2.1.1 General

The DICOM Application Context Name (ACN), which is always proposed, is:

Application Context Name	1.2.840.10008.3.1.1.1
---------------------------------	------------------------------

The maximum length PDU negotiation is included in all association establishment requests.

The maximum length PDU for an association initiated by the DICOM SERVER AE is:

Maximum Length PDU	28672 Bytes
---------------------------	--------------------

The SOP Class Extended Negotiation is not supported.

The maximum number of Presentation Context Items that will be proposed is 1

The user information Items sent by this product are:

- Maximum PDU Length
- Implementation UID

2.3.2.1.2 Number of Associations

The DICOM STORAGE COMMITMENT SERVER AE will initiate only one DICOM association at a time to perform a DICOM storage commitment operation as a SCU to a Remote DICOM AE.

The DICOM STORAGE COMMITMENT SERVER AE can have a maximum of 2 open DICOM associations at a time to perform a DICOM storage commitment operation as a SCU during Role/selection negotiation.

2.3.2.1.3 Asynchronous Nature

Asynchronous mode is not supported. All operations will be performed synchronously.

2.3.2.1.4 Implementation Identifying Information

The Implementation UID for this DICOM Implementation is:

Advantage Workstation 4.2 Implementation UID	1.2.840.113619.6.144
---	-----------------------------

2.3.2.1.5 Real-World Activity: Initiate Storage Commitment to a Remote AE

2.3.2.1.5.1 Associated Real-World Activity

The operator can associate a DICOM Storage Commitment Provider AE to a Remote AE.

The operator selects in the BROWSER one or several studies, series or images to be sent. Then, the user can either drag and drop the selection on the icon representing then Remote DICOM AE, or click on the “Push” icon and select a Remote DICOM AE in the LIST OF REMOTE HOST.

This operation will cause the following actions:

- The Advantage Workstation 4.2 retrieves the appropriate DICOM images to push from its database.
- The DICOM SERVER AE initiates a DICOM association, negotiates with the Remote AE an appropriate Abstract and Transfer Syntax.

- If the negotiation is successful, the DICOM SERVER AE emits C-STORE command to send the images to the Remote AE.
- When the images have been sent, the DICOM SERVER AE asks the DICOM STORAGE COMMITMENT SERVER AE to commit all the images that have been successfully sent.
- The DICOM STORAGE COMMITMENT SERVER AE initiates a DICOM association, negotiates with the Remote AE an appropriate Abstract and Transfer Syntax.
- If the negotiation is successful, the DICOM STORAGE COMMITMENT SERVER AE emits a N-ACTION request. Only one N-ACTION request is sent for all images to be committed.
- If the DICOM STORAGE COMMITMENT SERVER AE receives a successful N-ACTION RSP, the server waits a configurable period of time (default = 10s) for the reception of a N_EVENT_REPORT. (See section *Real-World Activity “Listen to remote Storage Commitment SCP”*)

2.3.2.1.5.2 Association Initiation Policy

Only one N-ACTION request is sent for all images that have been sent during the Real World Activity: “Push Studies/Series/images to Remote AE”

2.3.2.1.5.3 Proposed Presentation Context

Presentation Context Table - Proposed					
Abstract Syntax		Transfer Syntax		Role	Extended Negotiation
Name	UID	Name List	UID List		
Storage Commitment Push Model	1.2.840.10008.1.20.1	Explicit VR Big Endian	1.2.840.10008.1.2.2	SCU	None
Storage Commitment Push Model	1.2.840.10008.1.20.1	Explicit VR Little Endian	1.2.840.10008.1.2.1	SCU	None
Storage Commitment Push Model	1.2.840.10008.1.20.1	Implicit VR Little Endian	1.2.840.10008.1.2	SCU	None

2.3.2.1.5.3.1 SOP Specific DICOM Conformance Statement for the Storage Commitment Push Model SOP Class (N-ACTION)

If the received N-ACTION Response from the Storage Commitment Provider has a failure status, an error file is logged, the Storage Commitment is abandoned and a pop-up is displayed to the user.

If the received N-ACTION Response from the Storage Commitment Provider has a success status, the DICOM STORAGE COMMITMENT SERVER AE waits for an N-EVENT-REPORT during a configurable period of time. This period is set to 10s by default.

The DICOM STORAGE COMMITMENT SERVER AE can receive a N-EVENT-REPORT from the Storage Commitment Provider at any time (See section *Real-World Activity “Listen to remote Storage Commitment SCP”*).

2.3.2.1.6 Real-World Activity: Listen to remote Storage Commitment SCP

The DICOM STORAGE COMMITMENT SERVER AE is indefinitely listening for associations. No operator action is required to receive a Storage Commitment notification (N-EVENT-REPORT).

2.3.2.1.6.1 Associated Real-World Activity

The Real-World Activity associated consists into:

- Flag the images that have been committed (transfer of ownership) in the database.
- Pop up an error when some images of a patient existing in the database have not been committed.

2.3.2.1.6.2 Association Initiation Policy

The Storage Commitment Provider initiating the association must use the role selection negotiation.

2.3.2.1.6.3 Proposed Presentation Context

Presentation Context Table - Proposed					
Abstract Syntax		Transfer Syntax		Role	Extended Negotiation
Name	UID	Name List	UID List		
Storage Commitment Push Model	1.2.840.10008.1.20.1	Explicit VR Big Endian	1.2.840.10008.1.2.2	SCU	None
Storage Commitment Push Model	1.2.840.10008.1.20.1	Explicit VR Little Endian	1.2.840.10008.1.2.1	SCU	None
Storage Commitment Push Model	1.2.840.10008.1.20.1	Implicit VR Little Endian	1.2.840.10008.1.2	SCU	None

2.3.2.1.6.3.1 SOP Specific DICOM Conformance Statement for the Storage Commitment Push Model SOP Class (N-EVENT-REPORT)

Following are the status codes the Application may send back to the SCP Equipment after receiving the N-EVENT-REPORT:

Service Status	Status Codes	Further Meaning	Status Code sending explanation	Related Fields sent back to the SCU
Error	0110	Processing Failure	Indicates that an internal error occurs while processing.	None
Success	0000			None

The DICOM STORAGE COMMITMENT SERVER AE parses all the items present in the N-EVENT-REPORT.

For each image successfully committed, the image is flagged as “Committed” into the database. An error is logged for any image that cannot be committed and a pop up is displayed to the user when the image still exists in the database.

2.3.2.1.7 Real-World Activity: Open periodic association

2.3.2.1.7.1 Associated Real-World Activity

The operator can associate a DICOM Storage Commitment Provider AE to a Remote AE.

The system periodically scans the configuration file and opens an “empty” association with all the Remote DICOM AE declared as Storage Commitment Provider.

This periodic association enables a Storage Commitment Provider to send an N_EVENT_REPORT during a standard association negotiation.

This operation will cause the following actions:

- The DICOM STORAGE COMMITMENT SERVER AE initiates a DICOM association, negotiates with the Remote AE an appropriate Abstract and Transfer Syntax.
- If the negotiation is successful, the DICOM STORAGE COMMITMENT SERVER AE waits a configurable period of time (default = 10s) for the reception of a N_EVENT_REPORT. (See section *Real-World Activity “Listen to remote Storage Commitment SCP”*)

2.3.2.1.7.2 Association Initiation Policy

After the association negotiation, the DICOM STORAGE COMMITMENT SERVER AE waits for an incoming N_EVENT_REPORT.

2.3.2.1.7.3 Proposed Presentation Context

Presentation Context Table - Proposed					
Abstract Syntax		Transfer Syntax		Role	Extended Negotiation
Name	UID	Name List	UID List		
Storage Commitment Push Model	1.2.840.10008.1.20.1	Explicit VR Big Endian	1.2.840.10008.1.2.2	SCU	None
Storage Commitment Push Model	1.2.840.10008.1.20.1	Explicit VR Little Endian	1.2.840.10008.1.2.1	SCU	None
Storage Commitment Push Model	1.2.840.10008.1.20.1	Implicit VR Little Endian	1.2.840.10008.1.2	SCU	None

2.3.2.1.7.3.1 SOP Specific DICOM Conformance Statement for the Storage Commitment Push Model SOP Class (N-ACTION)

If the received N-ACTION Response from the Storage Commitment Provider has a failure status, an error file is logged, the Storage Commitment is abandoned and a pop-up is displayed to the user.

If the received N-ACTION Response from the Storage Commitment Provider has a success status, the DICOM STORAGE COMMITMENT SERVER AE waits for an N-EVENT-REPORT during a configurable period of time. This period is set to 10s by default.

The DICOM STORAGE COMMITMENT SERVER AE can receive a N-EVENT-REPORT from the Storage Commitment Provider at any time (See section *Real-World Activity "Listen to remote Storage Commitment SCP"*).

2.4 COMMUNICATION PROFILES

2.4.1 Supported Communication Stacks (PS 3.8, PS 3.9)

DICOM Upper Layer (PS 3.8) is supported using TCP/IP.

2.4.2 OSI Stack

OSI stack not supported

2.4.3 TCP/IP Stack

The TCP/IP stack is inherited from a UNIX Operating System.

2.4.3.1 API

Not applicable to this product.

2.4.3.2 Physical Media Support

DICOM is indifferent to the Physical medium over which TCP/IP executes (e.g. Ethernet V2.0, IEEE 802.3, ATM, FDDI, Ethernet 100Mb)

Note: For more information about the Physical Media available for Advantage Workstation 4.2, please refer to the Product Data Sheet.

2.4.4 Point-to-Point Stack

A 50-pin ACR-NEMA connection is not applicable to this product.

2.5 EXTENSIONS / SPECIALIZATIONS / PRIVATIZATIONS

2.5.1 Standard Extended /Specialized/Private SOPs

Some Private SOP Classes can be used by this product but are not exported outside of the station and so are not described below.

2.5.1.1 Private SOP Class GE DICOM Private 3D object

This SOP Class is described in document with Direction Number: 2198583-100

2.5.1.2 Private SOP Class GE DICOM RT Plan

This SOP Class is described in document with Direction Number 2180316-100.

2.5.1.3 Extended Enhanced SR object

The extension of this SOP Class is described in paragraph 7 - ENHANCED SR INFORMATION OBJECT IMPLEMENTATION.

The Enhanced DICOM SR does not implement the TID 2000 but the private ELECTRONIC FILM TID. Refer to §7.

2.5.1.4 Extended Secondary Capture object

The extension of this SOP Class is described in paragraph 6 - SC INFORMATION OBJECT IMPLEMENTATION.

2.5.2 Private Transfer Syntaxes

No private Transfer Syntax is negotiated.

2.6 CONFIGURATION

2.6.1 AE Title/Presentation Address Mapping

The GE Field Engineer must configure the hostname of the station during installation. The hostname will then be used for the AET address mapping.

DICOM SERVER AE

The Local AE Title is set to hostname.

DICOM STORAGE COMMITMENT SERVER AE

The Local AE Title is set to SCU_hostname.

Note: The GE Field Engineer can update the DICOM STORAGE COMMITMENT SERVER AET in a configuration file.

2.6.2 Configurable Parameters

The following fields are configurable for the DICOM SERVER AE (local):

- Local AET
- Local IP Address (defined by the station)
- Local IP Netmask (defined by the station)

The Local Listening Port Number is not configurable and set to **4006**.

The following fields are configurable for the DICOM STORAGE COMMITMENT SERVER AE (local):

- Local AE Title
- Local IP Address (defined by the station)
- Local IP Netmask (defined by the station)

The Local Listening Port Number is configurable and set to **4008**.

The following fields are configurable for every remote DICOM AE:

- Remote AE Title
- Remote IP Address
- Listening TCP/IP Port Number

A **default router** IP Address for **all remote nodes** can be configured as well as some specific routes.

The following fields are configurable:

- Association Establishment Timer
- Store, Find, Move, Timers
- Inactivity Timers
- Maximum Length PDU

Note: A GE Field Engineer must perform all configurations.

2.7 SUPPORT OF EXTENDED CHARACTER SETS

The Advantage Workstation 4.2 will support only the ISO_IR 100 (ISO 8859-1:1987 Latin alphabet N 1. supplementary set) as extended character sets.

3. MEDIA STORAGE CONFORMANCE STATEMENT

3.1 INTRODUCTION

This section of the conformance statement (CS) specifies the Advantage Workstation 4.2 compliance to DICOM Media Interchange. It details the DICOM Media Storage Application Profiles and roles that are supported by this product.

This station provides capabilities to DICOM interchange on MODs (Magneto Optical Disk), CD-Rs (Compact Disc-Recordable) with different application profiles supported. Basically, the Advantage Workstation 4.2 works with Computed Tomography (CT), Magnetic Resonance (MR), Computed Radiography (CR), XRay Angiographic (XA), XRay Fluoroscopic (RF), Positron Emission Tomography (PET) images and Secondary Captures (SC). Other applications may be used on the Advantage Workstation 4.2 basis and may use or create other types of objects. Please, refer to the DICOM conformance statement of each added application for a complete description of their compliance to DICOM media interchange.

Note that the format of this section strictly follows the format defined in DICOM Standard PS 3.2 (Conformance). Please refer to that part of the standard while reading this section.

3.2 IMPLEMENTATION MODEL

3.2.1 Application Data Flow Diagram

The Basic and Specific Application models for the CDR device are shown in the following Illustrations:

SPECIFIC AE APPLICATION MODEL FOR THE CDR DEVICE

- Description of the data Flow Diagram for the CD-R device.

The CD-R/CD-ROM DICOM Media Server Application Entity (AE) handles the DICOM CREATE CD/RESTORE CD functionality for the CD-R device. The CD-R/CD-ROM DICOM Media Server Application Entity (AE) is commanded by the user to perform DICOM services operating on the DICOM media through the use of buttons and menu selections on the graphical user interface of the station.

The user requests the creation of a DICOM File Set and the writing of this DICOM File Set on blank CD-Rs by selecting images in the local Browser and selecting the CD-R as being the selected device. Then, the images of the different CDs to burn will be generated. Once the generation has been done, the user can ask to burn the complete set of data on one or more CDs.

The user can request the reading of a DICOM file set written on a CDROM by selecting the CD-R drive as the active device, and browsing the CDROM using the "Query" Item of the device drop down menu, and then restore the selected items by a drag and drop on the local browser icon or by clicking on the suitable restore buttons.

The Application models for the CDR device are shown in illustration 3.1:

CDR/CDROM DICOM Media Server AE Model

Illustration 3.1

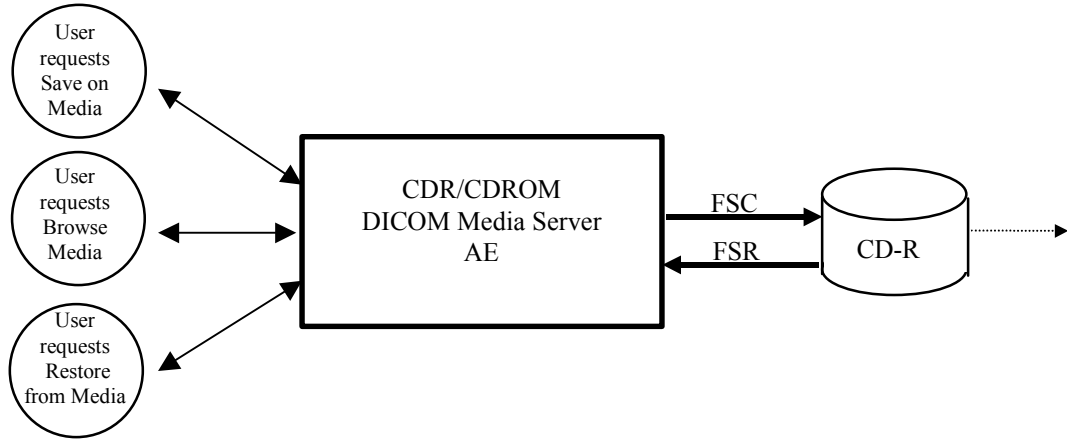

- Description of the data Flow Diagram for the MOD device.

The MOD DICOM Media Server Application Entity (AE) handles the DICOM RESTORE MOD functionality for the MOD device. The MOD DICOM Media Server Application Entity (AE) is commanded by the user to perform DICOM services operating on the DICOM media through the use of buttons and menu selections on the graphical user interface of the station.

The user can request the reading of a DICOM file set written on a MOD by selecting the MOD drive and browsing the media using the "Query" Item of the Media pull down menu, and then restore the selected items by a drag and drop on the local browser icon or by clicking on the suitable restore buttons

MOD DICOM Media Server AE Model

Illustration 3-2

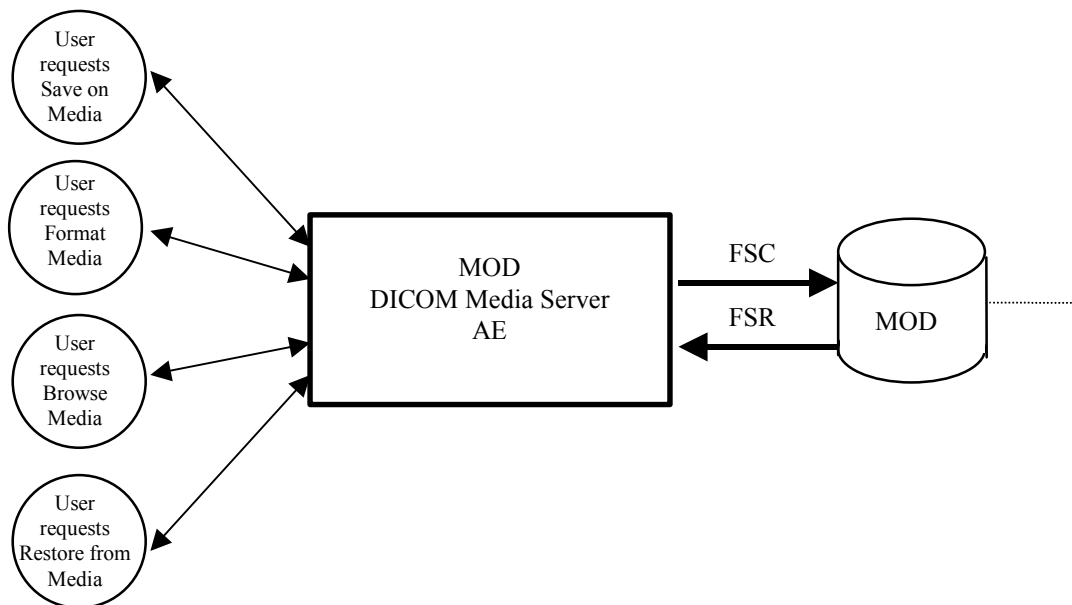

3.2.2 Functional Definition of AE's

3.2.3 Functional Definition of the DICOM Media Server AE

3.2.3.1 Functional definition of the CDR/CDROM DICOM Media Server AE

The CDR DICOM Media Server Application Entity supports the following functions:

- Has access to patient demographics and pixel data in the local database.
- Can generate a DICOM File Set (FSC) in a one shot activity.
- Can write a DICOM File Set (FSC) on a CD-R.
- Can read a DICOM File Set (FSR) on a CDROM.

3.2.3.2 Functional definition of the MOD DICOM Media Server AE

The MOD DICOM Media Server Application Entity supports the following functions:

- Has access to patient demographics and pixel data in the local database.
- Can generate a DICOM File Set (FSC) for CT, MR and Secondary Capture that has the CT or MR modality.
- Can write a DICOM File Set (FSC) on a MOD. The write can empty the DICOM File Set that corresponds to a format of the MOD media or can add new Patient Folders/Studies/Series/Images.
- Can read a DICOM File Set (FSR) on a MOD.

3.2.4 Sequencing Requirements

For writing on empty MODs, it is necessary to format the MOD before the user can request for writing images on MOD.

For writing on CD-Rs, it is necessary to use blank CD-Rs.

3.3 AE SPECIFICATIONS

3.3.1 DICOM CDR/CDROM SERVER AE Specification

The DICOM CDR/CDROM SERVER Application Entity provides standard conformance to DICOM Interchange Option of the Media Storage Service Class. The application Profiles and roles are listed below.

Supported Application Profile	Real World Activity	Role	Description
STD-GEN-CD AUG-XABC-CD, STD-XABC-CD	Browse CD	FSR	Interchange
STD-GEN-CD AUG-XABC-CD, STD-XABC-CD	Restore CD	FSR	Interchange
STD-GEN-CD AUG-XABC-CD	Create CD	FSC See Note	Interchange

Note: The DICOM CDR/CDROM Media Server AE will not create strictly STD-XABC-CD CDROMs unless the user saves images that are conformant with this profile.

3.3.1.1 File Meta Information for the DICOM CDR/CDROM Application Entity

Following are the values set in the File Meta Information for this AE Title:

Implementation Class UID	1.2.840.113619.6.144
Implementation Version Name	The Implementation Version Name is set dynamically through an environment variable
Source Application Entity Title	The Source Application Entity Title is derived from the hostname

3.3.1.2 Real-World Activities for the DICOM CDR/CDROM Application Entity

3.3.1.2.1 Real-World Activity (RWA) "Browse CD"

The CD-R/CDROM DICOM Media Server AE acts as an FSR using the interchange option when requested to browse the CD.

When the CD-R/CDROM DICOM Media Server AE is requested to provide a directory listing, it reads the File-set and displays the DICOMDIR directory entries, according to the PATIENT, STUDY, SERIES, IMAGE paradigm.

If the DICOMDIR file is not found in the File-set, the CD is ejected of the drive.

3.3.1.2.1.1 Media Storage Application Profile for the RWA "Browse CD":

For the list of Application Profiles that invoke this AE for the Browse CD RWA, see the Table in Section 3.3.1

3.3.1.2.1.1.1 Options:

Following are the SOP Classes supported by the RWA "Browse CD":

Information Object Definition	SOP Class UID	Transfer Syntax	Transfer Syntax UID
Media Storage Directory Storage	1.2.840.10008.1.3.10	Explicit VR Little Endian	1.2.840.10008.1.2.1

3.3.1.2.2 Real-World Activity (RWA) "Restore CD"

The CD-R/CDROM DICOM Media Server AE acts as an FSR using the interchange option when requested to copy SOP instances from the CD to the local database.

The user selects the SOP instances that he wants the DICOM Media Server AE to copy on the local database by a drag and drop on the local browser icon or by clicking on the suitable restore buttons. Once selected, the SOP instances are copied from the media to the local database.

Only, the SOP classes supported by the station are declared to the database in a transfer syntax supported by the station.

3.3.1.2.2.1 Media Storage Application Profile for the RWA “Restore CD”:

For the list of Application Profiles that invoke this AE for the Restore CD RWA, see the Table in Section 3.3.1.

3.3.1.2.2.1.1 Options:

Following are the SOP Classes supported by the RWA “Restore CD”:

Information Object Definition	SOP Class UID	Transfer Syntax	Transfer Syntax UID
Computed Radiographic Image Storage	1.2.840.10008.5.1.4.1.1.1	Explicit VR Little Endian	1.2.840.10008.1.2.1
CT Image Storage	1.2.840.10008.5.1.4.1.1.2	Explicit VR Little Endian	1.2.840.10008.1.2.1
MR Image Storage	1.2.840.10008.5.1.4.1.1.4	Explicit VR Little Endian	1.2.840.10008.1.2.1
Xray Angiographic Image Storage	1.2.840.10008.5.1.4.1.1.12.1	Explicit VR Little Endian JPEG lossless Process 14 (selection value 1) for images 512x512 (8bits).	1.2.840.10008.1.2.1 1.2.840.10008.1.2.4.70 for images 512x512 (8bits).
Xray Radiofluoroscopic Image Storage	1.2.840.10008.5.1.4.1.1.12.2	Explicit VR Little Endian	1.2.840.10008.1.2.1
Secondary Capture Image Storage	1.2.840.10008.5.1.4.1.1.7	Explicit VR Little Endian	1.2.840.10008.1.2.1
Digital X-Ray Image Storage - For Presentation	1.2.840.10008.5.1.4.1.1.1.1	Explicit VR Little Endian	1.2.840.10008.1.2.1
Digital X-Ray Image Storage - For Processing	1.2.840.10008.5.1.4.1.1.1.1.1	Explicit VR Little Endian	1.2.840.10008.1.2.1
Digital Mammography X-Ray Image Storage - For Presentation	1.2.840.10008.5.1.4.1.1.1.2	Explicit VR Little Endian	1.2.840.10008.1.2.1
Digital Mammography X-Ray Image Storage - For Processing	1.2.840.10008.5.1.4.1.1.1.2.1	Explicit VR Little Endian	1.2.840.10008.1.2.1
Nuclear Medicine Image Storage	1.2.840.10008.5.1.4.1.1.20	Explicit VR Little Endian	1.2.840.10008.1.2.1
Standalone Curve Storage	1.2.840.10008.5.1.4.1.1.9	Explicit VR Little Endian	1.2.840.10008.1.2.1
Positron Emission Tomography Image Storage	1.2.840.10008.5.1.4.1.1.128	Explicit VR Little Endian	1.2.840.10008.1.2.1
Standalone PET Curve Storage	1.2.840.10008.5.1.4.1.1.129	Explicit VR Little Endian	1.2.840.10008.1.2.1
RT Image Storage	1.2.840.10008.5.1.4.1.1.481.1	Explicit VR Little Endian	1.2.840.10008.1.2.1
RT Structure Set Storage	1.2.840.10008.5.1.4.1.1.481.3	Explicit VR Little Endian	1.2.840.10008.1.2.1
RT Plan Storage	1.2.840.10008.5.1.4.1.1.481.5	Explicit VR Little Endian	1.2.840.10008.1.2.1
GE Private DICOM RT Plan	1.2.840.113619.4.5.249	Explicit VR Little Endian	1.2.840.10008.1.2.1
NM Genie Private Data	1.2.840.113619.4.27	Explicit VR Little Endian	1.2.840.10008.1.2.1

PET Advance Private Data	1.2.840.113619.4.30	Explicit VR Little Endian	1.2.840.10008.1.2.1
GE Private DICOM 3D object	1.2.840.113619.4.26	Explicit VR Little Endian	1.2.840.10008.1.2.1
Ultrasound Image Storage	1.2.840.10008.5.1.4.1.1.6.1	Explicit VR Little Endian	1.2.840.10008.1.2.1
Ultrasound Multi-frame Image Storage	1.2.840.10008.5.1.4.1.1.3.1	Explicit VR Little Endian	1.2.840.10008.1.2.1
Ultrasound Image Storage (Retired)	1.2.840.10008.5.1.4.1.1.6	Explicit VR Little Endian	1.2.840.10008.1.2.1
Ultrasound Multi-frame Image Storage (Retired)	1.2.840.10008.5.1.4.1.1.3	Explicit VR Little Endian	1.2.840.10008.1.2.1
Basic Text SR	1.2.840.10008.5.1.4.1.1.88.11	Explicit VR Little Endian	1.2.840.10008.1.2.1
Enhanced SR	1.2.840.10008.5.1.4.1.1.88.22	Explicit VR Little Endian	1.2.840.10008.1.2.1
Comprehensive SR	1.2.840.10008.5.1.4.1.1.88.33	Explicit VR Little Endian	1.2.840.10008.1.2.1
Mammography CAD SR	1.2.840.10008.5.1.4.1.1.88.50	Explicit VR Little Endian	1.2.840.10008.1.2.1

3.3.1.2.3 Real-World Activity (RWA) "Create CD"

The CD-R/CDROM DICOM Media Server acts as an FSC using the interchange option when requested to copy SOP Instances from the local database to one or multiple CD-Rs.

The user selects the entries in the local database that he wants the CD-R/CDROM DICOM Media Server to copy onto CD-Rs.

The graphic interface (CD Composer) allows the user to select the entries in the local database to be copied onto one or more CDs. He/she may

- Add patients, studies, series or images from the local database onto the CD Composer
- Remove patients, studies, series or images from the CD Composer.

The CD Composer will create one File Set per generated CD-Rs.

The user has the opportunity to choose some options before composing the CD-Rs:

- The DICOM profile used for writing the CD-Rs. The user has the opportunity to choose:
 - the "General Purpose Profile" (STD-GEN-CD): All the selected items will be saved using the STD-GEN-CD profile.
 - the "XA Augmented Cardiac Profile" (AUG-XABC-CD): The selected XA 512x512 (8 bits) images will be saved using the STD-XABC-CD and all the other items will be saved on the Interchange media using the STD-GEN-CD profile.
- Burn a DICOM CD-Viewer along with the images.
- Reduce the resolution of XA Cardiac images to 512x512x8bits. This procedure is the *downscan processing* and it manages images of the following resolutions: 1000x1000x8bits, 864x864x8bits, 800x800x8bits, 736x736x8bits, and 608x608x8bits. The CD-R/CDROM DICOM Media Server will generate new images from the input images.

The user has the opportunity to choose some options after composing the CD-Rs:

- Read after write mode to check the binary integrity of what is written on each CD-R.
- Update the number of copies to generate.

The user has to insert blank CD-Rs into the CD-R drive. Before writing the CD-R, the CD-R/CDROM DICOM Media Server checks for the following condition:

- The inserted media is blank and writable. If the condition is not met, an error is displayed and the CD is ejected.

Note: The corresponding SOP instances have to be encoded with the ISO_IR 100 Specific Character Set or DICOM Default Character Set.

Note: The corresponding SOP instances are set to the transfer syntax defined by the application and copied to the CD. Unknown Private Data Elements are encoded with the DICOM unknown Value Representation.

3.3.1.2.3.1 Media Storage Application Profile for the RWA “Create CD”:

This AE can use the STD-GEN-CD or the AUG-XABC-CD profiles for the Create CD RWA.

Please refer to the Table in Section 3.3.1.

3.3.1.2.3.1.1 Options:

Following are the SOP Classes supported by the RWA “Create CD”:

Information Object Definition	SOP Class UID	Transfer Syntax	Transfer Syntax UID
Media Storage Directory Storage	1.2.840.10008.1.3.10	Explicit VR Little Endian	1.2.840.10008.1.2.1
Computed Radiographic Image Storage	1.2.840.10008.5.1.4.1.1.1	Explicit VR Little Endian	1.2.840.10008.1.2.1
CT Image Storage	1.2.840.10008.5.1.4.1.1.2	Explicit VR Little Endian	1.2.840.10008.1.2.1
MR Image Storage	1.2.840.10008.5.1.4.1.1.4	Explicit VR Little Endian	1.2.840.10008.1.2.1
Xray Angiographic Image Storage	1.2.840.10008.5.1.4.1.1.12.1	Explicit VR Little Endian JPEG lossless Process 14 (selection value 1) for images 512x512 (8bits).	1.2.840.10008.1.2.1 1.2.840.10008.1.2.4.70 for images 512x512 (8bits).
Xray Radiofluoroscopic Image Storage	1.2.840.10008.5.1.4.1.1.12.2	Explicit VR Little Endian	1.2.840.10008.1.2.1
Secondary Capture Image Storage	1.2.840.10008.5.1.4.1.1.7	Explicit VR Little Endian	1.2.840.10008.1.2.1
Digital X-Ray Image Storage - For Presentation	1.2.840.10008.5.1.4.1.1.1.1	Explicit VR Little Endian	1.2.840.10008.1.2.1
Digital X-Ray Image Storage - For Processing	1.2.840.10008.5.1.4.1.1.1.1.1	Explicit VR Little Endian	1.2.840.10008.1.2.1
Digital Mammography X-Ray Image Storage - For Presentation	1.2.840.10008.5.1.4.1.1.1.2	Explicit VR Little Endian	1.2.840.10008.1.2.1
Digital Mammography X-Ray Image Storage - For Processing	1.2.840.10008.5.1.4.1.1.1.2.1	Explicit VR Little Endian	1.2.840.10008.1.2.1
Nuclear Medicine Image Storage	1.2.840.10008.5.1.4.1.1.20	Explicit VR Little Endian	1.2.840.10008.1.2.1

Standalone Curve Storage	1.2.840.10008.5.1.4.1.1.9	Explicit VR Little Endian	1.2.840.10008.1.2.1
Positron Emission Tomography Image Storage	1.2.840.10008.5.1.4.1.1.128	Explicit VR Little Endian	1.2.840.10008.1.2.1
Standalone PET Curve Storage	1.2.840.10008.5.1.4.1.1.129	Explicit VR Little Endian	1.2.840.10008.1.2.1
RT Image Storage	1.2.840.10008.5.1.4.1.1.481.1	Explicit VR Little Endian	1.2.840.10008.1.2.1
RT Structure Set Storage	1.2.840.10008.5.1.4.1.1.481.3	Explicit VR Little Endian	1.2.840.10008.1.2.1
RT Plan Storage	1.2.840.10008.5.1.4.1.1.481.5	Explicit VR Little Endian	1.2.840.10008.1.2.1
GE Private DICOM RT Plan	1.2.840.113619.4.5.249	Explicit VR Little Endian	1.2.840.10008.1.2.1
NM Genie Private Data	1.2.840.113619.4.27	Explicit VR Little Endian	1.2.840.10008.1.2.1
PET Advance Private Data	1.2.840.113619.4.30	Explicit VR Little Endian	1.2.840.10008.1.2.1
GE Private DICOM 3D object	1.2.840.113619.4.26	Explicit VR Little Endian	1.2.840.10008.1.2.1
Ultrasound Image Storage	1.2.840.10008.5.1.4.1.1.6.1	Explicit VR Little Endian	1.2.840.10008.1.2.1
Ultrasound Multi-frame Image Storage	1.2.840.10008.5.1.4.1.1.3.1	Explicit VR Little Endian	1.2.840.10008.1.2.1
Ultrasound Image Storage (Retired)	1.2.840.10008.5.1.4.1.1.6	Explicit VR Little Endian	1.2.840.10008.1.2.1
Ultrasound Multi-frame Image Storage (Retired)	1.2.840.10008.5.1.4.1.1.3	Explicit VR Little Endian	1.2.840.10008.1.2.1
Basic Text SR	1.2.840.10008.5.1.4.1.1.88.11	Explicit VR Little Endian	1.2.840.10008.1.2.1
Enhanced SR	1.2.840.10008.5.1.4.1.1.88.22	Explicit VR Little Endian	1.2.840.10008.1.2.1
Comprehensive SR	1.2.840.10008.5.1.4.1.1.88.33	Explicit VR Little Endian	1.2.840.10008.1.2.1
Mammography CAD SR	1.2.840.10008.5.1.4.1.1.88.50	Explicit VR Little Endian	1.2.840.10008.1.2.1

3.3.2 DICOM MOD SERVER AE Specification

The DICOM MOD SERVER Application Entity provides standard conformance to DICOM Interchange Option of the Media Storage Service Class. The application Profiles and roles are listed below.

Supported Application Profile	Real World Activity	Role	Description
STD-CTMR-MOD12 STD-CTMR-MOD23 PRI-CTMR-MOD12	Browse MOD	FSR	Interchange
STD-CTMR-MOD12 STD-CTMR-MOD23	Restore MOD	FSR	Interchange

STD-CTMR-MOD12	Create MOD	FSC	Interchange
STD-CTMR-MOD23			
STD-CTMR-MOD12	Format	FSC	Interchange
STD-CTMR-MOD23			

3.3.2.1 File Meta Information for the DICOM MOD Application Entity

Following are the values set in the File Meta Information for this AE Title:

Implementation Class UID	1.2.840.113619.6.144
Implementation Version Name	The Implementation Version Name is set dynamically through an environment variable

3.3.2.2 Real-World Activities for the DICOM MOD Application Entity

3.3.2.2.1 Real-World Activity (RWA) "Browse MOD"

The MOD DICOM Media Server AE acts as an FSR using the interchange option when requested to browse the MOD.

When the MOD DICOM Media Server AE is requested to provide a directory listing, it reads the File-set and displays the DICOMDIR directory entries, according to the PATIENT, STUDY, SERIES, IMAGE paradigm.

If the DICOMDIR file is not found in the File-set, the MOD is considered as not formatted.

Only a DICOMDIR that conforms strictly to the DICOM Standard Supplement 18 or the GE Private Profile (PRI-CTMR-MOD12) will be considered as readable.

3.3.2.2.1.1 Media Storage Application Profile for the RWA "Browse MOD":

For the list of Application Profiles that invoke this AE for the Browse MOD RWA, see the Table in Section 3.3.2.

3.3.2.2.1.1.1 Options:

Following are the SOP Classes supported by the RWA "Browse MOD":

Information Object Definition	SOP Class UID	Transfer Syntax	Transfer Syntax UID
Media Storage Directory Storage	1.2.840.10008.1.3.10	Explicit VR Little Endian	1.2.840.10008.1.2.1

3.3.2.2.2 Real-World Activity (RWA) "Restore MOD"

The MOD DICOM Media Server AE acts as an FSR using the interchange option when requested to copy SOP instances from the MOD to the local database.

The user selects the SOP instances that he wants the DICOM Media Server AE to copy on the local database by a drag and drop on the local browser icon or by clicking on the suitable restore buttons. Once selected, the SOP instances are copied from the media to the local database.

Only, the SOP classes supported by the station are declared to the database in a transfer syntax supported by the station.

3.3.2.2.2.1 Media Storage Application Profile for the RWA “Restore MOD”:

For the list of Application Profiles that invoke this AE for the Restore CD RWA, see the Table in Section 3.3.2.

3.3.2.2.2.1.1 Options:

Following are the SOP Classes supported by the RWA “Restore MOD”:

Information Object Definition	SOP Class UID	Transfer Syntax	Transfer Syntax UID
CT Image Storage	1.2.840.10008.5.1.4.1.1.2	Explicit VR Little Endian	1.2.840.10008.1.2.1
CT Image Storage	1.2.840.10008.5.1.4.1.1.2	JPEG Lossless Process 14 (selection value 1)	1.2.840.10008.1.2.4.70
MR Image Storage	1.2.840.10008.5.1.4.1.1.4	Explicit VR Little Endian	1.2.840.10008.1.2.1
MR Image Storage	1.2.840.10008.5.1.4.1.1.4	JPEG Lossless Process 14 (selection value 1)	1.2.840.10008.1.2.4.70
Secondary Capture Image Storage (CT or MR modality)	1.2.840.10008.5.1.4.1.1.7	Explicit VR Little Endian	1.2.840.10008.1.2.1
Secondary Capture Image Storage (CT or MR modality)	1.2.840.10008.5.1.4.1.1.7	JPEG Lossless Process 14 (selection value 1)	1.2.840.10008.1.2.4.70

3.3.2.2.3 Real-World Activity (RWA) ”Create MOD”

The MOD DICOM Media Server acts as an FSC using the interchange option when requested to copy SOP Instances from the local database to the MOD.

The user has to insert a formatted MOD into the MOD drive. Then, the user selects the entries in the local database that he wants the MOD DICOM Media Server to copy onto the MOD.

Before writing the MOD, the MOD DICOM Media Server checks for the following conditions:

- The selected SOP Classes can be saved on the media. If the condition is not met, an error is displayed.
- The corresponding SOP instances have been encoded with the ISO_IR 100 Specific Character Set or the DICOM Default Character Set.

The corresponding SOP instances are set to the transfer syntax defined by the application and copied to the MOD. Unknown Private Data Elements are encoded with the DICOM unknown Value Representation.

3.3.2.2.3.1 Media Storage Application Profile for the RWA “Create MOD”:

This AE will use the STD-CTMR-MOD12 or STD-CTMR-MOD23 profiles for the RWA “Create MOD”.

The JPEG Lossless Process 14 - selection value 1 (1.2.840.10008.1.2.4.70) is chosen as the Transfer Syntax UID of objects stored on MODs. However, when icons are present in the header of the images, the Transfer Syntax UID of the image written on the MOD will be Explicit Little Endian (1.2.840.10008.1.2.1).

Please refer to the Table in Section 3.3.2.

3.3.2.2.3.1.1 Options:

Following are the SOP Classes supported by the RWA “Create MOD”:

Information Object Definition	SOP Class UID	Transfer Syntax	Transfer Syntax UID
Media Storage Directory Storage	1.2.840.10008.1.3.10	Explicit VR Little Endian	1.2.840.10008.1.2.1
CT Image Storage	1.2.840.10008.5.1.4.1.1.2	JPEG Lossless Process 14 (selection value 1)	1.2.840.10008.1.2.4.70
CT Image Storage	1.2.840.10008.5.1.4.1.1.2	Explicit VR Little Endian	1.2.840.10008.1.2.1
MR Image Storage	1.2.840.10008.5.1.4.1.1.4	JPEG Lossless Process 14 (selection value 1)	1.2.840.10008.1.2.4.70
MR Image Storage	1.2.840.10008.5.1.4.1.1.4	Explicit VR Little Endian	1.2.840.10008.1.2.1
Secondary Capture Image Storage	1.2.840.10008.5.1.4.1.1.7	JPEG Lossless Process 14 (selection value 1)	1.2.840.10008.1.2.4.70
Secondary Capture Image Storage	1.2.840.10008.5.1.4.1.1.7	Explicit VR Little Endian	1.2.840.10008.1.2.1

3.3.2.2.4 Real-World Activity (RWA) ”Format MOD”

The MOD DICOM Media Server acts as an FSC using the interchange option when requested to format (operation known as LABEL) MOD.

The user has to insert a blank or an already formatted MOD into the MOD drive. Then, the user clicks on the icon representing the MOD drive and selects the “Label” entry in the drop down menu.

The MOD DICOM Media Server AE then returns the current parameters of the MOD, and the user can confirm the LABEL.

Before erasing the data on the MOD, the MOD DICOM Media Server AE checks for the following conditions:

- The media is not “write protected”.

The RWA “Format MOD” will format a DOS file system on the MOD and an empty dicomdir.

3.3.2.2.4.1 Media Storage Application Profile for the RWA “Format MOD”:

This AE will use the STD-CTMR-MOD12 or STD-CTMR-MOD23 profiles for the RWA “Format MOD”.

Please refer to the Table in Section 3.3.2.

3.3.2.2.4.1.1 Options:

Following are the SOP Classes supported by the RWA “Format MOD”:

Information Object Definition	SOP Class UID	Transfer Syntax	Transfer Syntax UID
Media Storage Directory Storage	1.2.840.10008.1.3.10	Explicit VR Little Endian	1.2.840.10008.1.2.1

After the DOS format of the MOD, an empty DICOMDIR will be written on the MOD.

3.4 AUGMENTED AND PRIVATE APPLICATION PROFILES

One augmented profile is defined to create a CD of XA 512x512 (8bits) images along with other SOP Classes. This profile is defined as the AUG-XA-CD Application Profile.

3.4.1 Augmented Application Profiles

3.4.1.1 Augmented Application Profile AUG-XA-CD

The AE defines the augmented profile AUG-XA-CD derived from the STD-XA-CD profile.

3.4.1.1.1 SOP Class Augmentations

Information Object Definition	SOP Class UID	Transfer Syntax	Transfer Syntax UID
Computed Radiographic Image Storage	1.2.840.10008.5.1.4.1.1.1	Explicit VR Little Endian	1.2.840.10008.1.2.1
CT Image Storage	1.2.840.10008.5.1.4.1.1.2	Explicit VR Little Endian	1.2.840.10008.1.2.1
MR Image Storage	1.2.840.10008.5.1.4.1.1.4	Explicit VR Little Endian	1.2.840.10008.1.2.1
XRay Angiographic Image Storage	1.2.840.10008.5.1.4.1.1.12.1	JPEG lossless Process 14 (selection value 1) for images 512x512 (8bits). Explicit VR Little Endian for other XA images	1.2.840.10008.1.2.4.70 for images 512x512 (8bits). 1.2.840.10008.1.2.1 for other XA images
Xray Radiofluoroscopic Image Storage	1.2.840.10008.5.1.4.1.1.12.2	Explicit VR Little Endian	1.2.840.10008.1.2.1
Secondary Capture Image Storage	1.2.840.10008.5.1.4.1.1.7	Explicit VR Little Endian	1.2.840.10008.1.2.1
Digital X-Ray Image Storage - For Presentation	1.2.840.10008.5.1.4.1.1.1.1	Explicit VR Little Endian	1.2.840.10008.1.2.1
Digital X-Ray Image Storage - For Processing	1.2.840.10008.5.1.4.1.1.1.1.1	Explicit VR Little Endian	1.2.840.10008.1.2.1
Digital Mammography X-Ray Image Storage - For Presentation	1.2.840.10008.5.1.4.1.1.1.2	Explicit VR Little Endian	1.2.840.10008.1.2.1

Digital Mammography X-Ray Image Storage - For Processing	1.2.840.10008.5.1.4.1.1.1.2.1	Explicit VR Little Endian	1.2.840.10008.1.2.1
Nuclear Medicine Image Storage	1.2.840.10008.5.1.4.1.1.20	Explicit VR Little Endian	1.2.840.10008.1.2.1
Standalone Curve Storage	1.2.840.10008.5.1.4.1.1.9	Explicit VR Little Endian	1.2.840.10008.1.2.1
Positron Emission Tomography Image Storage	1.2.840.10008.5.1.4.1.1.128	Explicit VR Little Endian	1.2.840.10008.1.2.1
Standalone PET Curve Storage	1.2.840.10008.5.1.4.1.1.129	Explicit VR Little Endian	1.2.840.10008.1.2.1
RT Image Storage	1.2.840.10008.5.1.4.1.1.481.1	Explicit VR Little Endian	1.2.840.10008.1.2.1
RT Structure Set Storage	1.2.840.10008.5.1.4.1.1.481.3	Explicit VR Little Endian	1.2.840.10008.1.2.1
RT Plan Storage	1.2.840.10008.5.1.4.1.1.481.5	Explicit VR Little Endian	1.2.840.10008.1.2.1
GE Private DICOM RT Plan	1.2.840.113619.4.5.249	Explicit VR Little Endian	1.2.840.10008.1.2.1
NM Genie Private Data	1.2.840.113619.4.27	Explicit VR Little Endian	1.2.840.10008.1.2.1
PET Advance Private Data	1.2.840.113619.4.30	Explicit VR Little Endian	1.2.840.10008.1.2.1
GE Private DICOM 3D object	1.2.840.113619.4.26	Explicit VR Little Endian	1.2.840.10008.1.2.1
Ultrasound Image Storage	1.2.840.10008.5.1.4.1.1.6.1	Explicit VR Little Endian	1.2.840.10008.1.2.1
Ultrasound Multi-frame Image Storage	1.2.840.10008.5.1.4.1.1.3.1	Explicit VR Little Endian	1.2.840.10008.1.2.1
Ultrasound Image Storage (Retired)	1.2.840.10008.5.1.4.1.1.6	Explicit VR Little Endian	1.2.840.10008.1.2.1
Ultrasound Multi-frame Image Storage (Retired)	1.2.840.10008.5.1.4.1.1.3	Explicit VR Little Endian	1.2.840.10008.1.2.1
Basic Text SR	1.2.840.10008.5.1.4.1.1.88.11	Explicit VR Little Endian	1.2.840.10008.1.2.1
Enhanced SR	1.2.840.10008.5.1.4.1.1.88.22	Explicit VR Little Endian	1.2.840.10008.1.2.1
Comprehensive SR	1.2.840.10008.5.1.4.1.1.88.33	Explicit VR Little Endian	1.2.840.10008.1.2.1
Mammography CAD SR	1.2.840.10008.5.1.4.1.1.88.50	Explicit VR Little Endian	1.2.840.10008.1.2.1

3.4.1.1.2 Directory Augmentations

No Directory Augmentation is implemented.

3.4.1.1.3 Other Augmentations

No Other Augmentations are implemented.

3.4.2 Private Application Profiles

The GE Private DICOM Profile PRI-CTMR-MOD12 is implemented for the “Browse RWA” of the DICOM MOD Media Server AE.

The description of the private DICOM Profile PRI-CTMR-MOD12 can be found in the SIGNA HORIZON LX8.1 CONFORMANCE STATEMENT (Direction Number: 2171143-100).

3.5 EXTENSIONS, SPECIALIZATIONS, PRIVATIZATIONS OF SOP CLASSES AND TRANSFER SYNTAXES

This section describes the extension of SOP Classes used in the scope of the STD-GEN-CD and AUG-XA-CD Application Profiles.

3.5.1 Extensions, Specializations, and Privatizations of SOP Classes

3.5.1.1 SOP Specific Conformance Statement for SOP Media Storage Directory

The following keys are added as Type 3 data elements in the Basic Directory IOD:

Key Attribute	Tag	Directory Record Type
Patient’s Birth Date	(0010,0030)	PATIENT
Patient’s Sex	(0010,0040)	PATIENT
Series Description	(0008,103E)	SERIES
Manufacturer	(0008,1090)	SERIES
Institution Name	(0008,0080)	SERIES
Institution Address	(0008,0081)	SERIES
Attending Physician’s Name	(0008,1050)	SERIES
Image Type	(0008,0008)	IMAGE
Image Date	(0008,0023)	IMAGE
Image Time	(0008, 0033)	IMAGE
Recommended Display Frame Rate	(0008,2144)	IMAGE
Radiation Settings	(0018,1155)	IMAGE (See Note 1)
Image Comments	(0020,4000)	IMAGE
Number Of Frames	(0028,0008)	IMAGE
Rows	(0028,0010)	IMAGE
Columns	(0028,0011)	IMAGE

Angle Value 1	(0019,xx01)	IMAGE (See Note 2)
Angle Value 2	(0019,xx02)	IMAGE (See Note 2)
Angle Value 3	(0019,xx03)	IMAGE (See Note 2)
Angle Label 1	(0019,xx04)	IMAGE (See Note 2)
Angle Label 2	(0019,xx05)	IMAGE (See Note 2)
Angle Label 3	(0019,xx06)	IMAGE (See Note 2)

Note: Radiation Settings can be valued for XA and RF images only.

Note: Private group 19 is written in the IMAGE record of the SOP Media Storage Directory if it is present in the original image from the GEMS DLX acquisition machine and Private Creator Identification is DLX_SERIE_01.

The XA images having the following attributes can be *downscanned* to 512x512x8bits:

- SOP Class UID (0008,0016) is “1.2.840.10008.5.1.4.1.1.12.1”.
- The “Can Downscan 512” private attribute (0019,xxAA, GEMS_DL_IMG_01) can be found in the data set, and its value is “YES”

or

the “Can Downscan 512” private attribute (0019,xxAA, GEMS_DL_IMG_01) cannot be found in the data set

and Manufacturer (0008,0070) is “GE MEDICAL SYSTEMS” and the Manufacturer’s Model Name (0008,1090) is “DL”

- Bits Allocated (0028,0100) is equal to 8.
- Bits Stored (0028,0101) is less than or equal to 8.
- Rows (0028,0010) and Columns (0028,0011) attributes have the following values: 1000 x 1000 or 864 x 864 or 800 x 800 or 736 x 736 or 608x608.

All other images can not be *downscanned*.

Note: The meaning of (0019,xxAA, GEMS_DL_IMG_01) is the private element (0019,xxAA) associated with the Private Creator Identification is GEMS_DL_IMG_01.

3.5.1.2 Private data dictionary

TABLE 3.5-1

PRIVATE CREATOR IDENTIFICATION (DLX_SERIE_01)

Attribute Name	Tag	VR	VM
Angle Value 1	(0019,xx01)	DS	1
Angle Value 2	(0019,xx02)	DS	1
Angle Value 3	(0019,xx03)	DS	1

Angle Label 1	(0019,xx04)	CS	1
Angle Label 2	(0019,xx05)	CS	1
Angle Label 3	(0019,xx06)	CS	1

3.5.2 Private Transfer Syntax Specification

No private Transfer Syntax is written on media by the described DICOM CDR/CDROM SERVER AE of Advantage Workstation 4.2.

3.6 CONFIGURATION

The source AE Title encoded in the File Meta-Information cannot be modified.

3.7 SUPPORT OF EXTENDED CHARACTER SETS

The Advantage Workstation 4.2 will support only the ISO_IR 100 (ISO 8859-1:1987 Latin alphabet N 1. supplementary set) as extended character sets. Any incoming SOP instance that is encoded using another extended character set will not be installed in the local database.

4. NETWORK PRINT SCU CONFORMANCE STATEMENT

4.1 INTRODUCTION

This section of the DICOM Conformance Statement specifies the compliance to DICOM conformance requirements for the relevant Grayscale and Color **Network Printing** features on this GEMS product. Note that the format of this section strictly follows the format defined in DICOM Standard PS 3.2 (Conformance). Please refer to that part of the standard while reading this section.

The Advantage Workstation 4.2 has the ability to compose films through the use of an application known as FILMER. The Advantage Workstation 4.2 uses DICOM Print Management Service Class to send images to hard copy printers. The films can then be used for possible further analysis.

4.2 IMPLEMENTATION MODEL

4.2.1 Application Data Flow Diagram

The Basic and Specific Application models for this device are shown in the following Illustration

DICOM Print SCU Application Entity Model

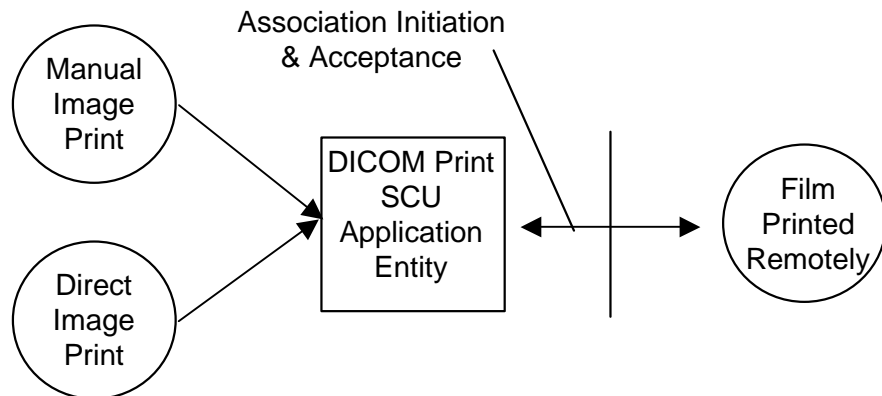

The DICOM Print SCU Application Entity (AE) is an application that handles the DICOM protocol communication with Remote DICOM Printers. The DICOM Print SCU AE is activated when the user requests for a print.

The DICOM Print SCU AE is invoked by the following Real World Activities:

- Manual Image Print

For this operation, the operator uses the *FILMER* application to prepare a layout of images and send the pages to the *PRINT MANAGER*.

- Direct Image Print

For this operation, the operator displays the images in the *VIEWER* and sends the images directly to the *PRINT MANAGER*.

In both cases, the PRINT MANAGER receives the “Simple print” request, composes a film then sends the film to the selected Remote DICOM Printer

4.2.2 Functional Definition of AE’S

The DICOM Print SCU AE supports the following functions:

- Access to pixel data
- Initiate a DICOM association to send DICOM SOP Classes (corresponding to the DICOM Print Management service class) to a remote DICOM Printer

4.2.3 Sequencing of Real-World Activities

4.2.3.1 Manual Image Print

The user selects the remote DICOM Printer from Print Manager Graphical User Interface.

1. The images to be printed shall be dragged and drop into the FILMER application either manually or automatically.
2. The PRINT MANAGER receives the “Simple print” request, composes a film then activates the DICOM Print SCU AE that initiates the following actions.
3. The PRINT MANAGER Initiates a DICOM association and selects a Presentation Context.
4. N-GETs printer status from the Printer SOP Instance
 - a. If the Printer Status is FAILURE
 - i. The failure is displayed to the user
 - ii. The association is aborted
 - b. Else
 - i. The warning is displayed to the user
 - ii. The Print goes on
 - c. Endif
5. N-CREATEs a Basic Film Session SOP Instance
6. N-CREATEs a Basic Film Box SOP Instance for the current film
7. N-SETs the Basic Film Box SOP Instance with the Image Box SOP Instance for each image on the film
8. N-ACTIONs on the Basic Film Box SOP Instance
9. N-DELETEs on the Basic Film Box SOP Instance
10. Releases the DICOM association after printing is successful or failure has been signaled to the user

Note: If DICOM_PRINT_WAIT_SCP_EVENT environment variable is set, then the DICOM print SCU handles the N-EVENT-REPORT sent by the printer but does not read the message content

4.3 AE SPECIFICATIONS

4.3.1 DICOM Print SCU AE Specification

This Application Entity provides Standard Conformance to the following DICOM SOP Classes as an SCU:

SOP Class Name	SOP Class UID
Basic Grayscale Print Management Meta SOP Class	1.2.840.10008.5.1.1.9
Basic Color Print Management Meta SOP Class	1.2.840.10008.5.1.1.18

Note: Support of the Basic Grayscale Print Management Meta SOP Class as an SCU mandates support for the Basic Film Session, Basic Film Box, Basic Grayscale Image Box and Printer SOP Classes as an SCU.

Note: Support of the Basic Color Print Management Meta SOP Class as an SCU mandates support for the Basic Film Session, Basic Film Box, Basic Color Image Box and Printer SOP Classes as an SCU.

4.3.1.1 Association Establishment Policies

4.3.1.1.1 General

The DICOM Application Context Name (ACN) that is always proposed is:

Application Context Name	1.2.840.10008.3.1.1.1
---------------------------------	------------------------------

The Maximum Length PDU negotiation is included in all association establishment requests.

The maximum length PDU for an association initiated by the DICOM Print SCU is:

Maximum Length PDU	28672 Bytes
---------------------------	--------------------

The Print Management Service Class does not support extended negotiation.

The user information Items sent by this product are:

- Maximum PDU Length
- Implementation UID

4.3.1.1.2 Number of Associations

The DICOM Print SCU AE supports only one association at a time. The printing requests are internally queued.

4.3.1.1.3 Asynchronous Nature

Asynchronous mode is not supported. All operations will be performed synchronously.

4.3.1.1.4 Implementation Identifying Information

The Implementation UID for this DICOM Implementation is:

Advantage Workstation 4.2 Implementation UID	1.2.840.113619.6.144
---	-----------------------------

4.3.1.1.5 Association Initiation Policy

4.3.1.1.6 Real-World Activity “Manual Image Print”

4.3.1.1.6.1 Associated Real-World Activity

The user has the possibility to drag and drop images from the VIEWER to the FILMER application. The Print Manager application allows to define, suppress and select different REMOTE DICOM printers and to manipulate some print parameters like the number of copies. When the user requests for a print by pushing the “Print” button, the DICOM Print SCU tries to establish the association with the requested printer and sends the images for printing.

4.3.1.1.6.2 Proposed Presentation Context Table

Presentation Context Table – Proposed					
Abstract Syntax		Transfer Syntax		Role	Extended Negotiation
Name	UID	Name List	UID List		
Basic Grayscale Print Management Meta SOP Class	1.2.840.10008.5.1.1.9	Implicit VR Little Endian	1.2.840.10008.1.2	SCU	None
Basic Color Print Management Meta SOP Class	1.2.840.10008.5.1.1.18	Implicit VR Little Endian	1.2.840.10008.1.2	SCU	None

4.3.1.1.6.2.1 SOP Specific DICOM Conformance Statement for Print Management SOP Classes

The DICOM Print SCU AE initiates one association with the selected REMOTE DICOM Printer. The DICOM Print SCU AE will not open another association while the current one is active.

The Basic Grayscale Print Management Meta SOP Class and the Color Grayscale Print Management Meta SOP Class are never negotiated simultaneously.

For each of the supported Print Management SOP and Meta SOP Classes, the optional attributes and service elements supported, the valid range of values for mandatory and optional attributes, and the status code behavior are described in Section 5.

4.3.1.1.7 Real-World Activity “Direct Image Print”

4.3.1.1.7.1 Associated Real-World Activity

The user has the possibility to directly send images from the VIEWER to the Print Manager application. The Print Manager application will launch the DICOM Print SCU that tries to establish the association with the default printer and sends the images for printing.

4.3.1.1.7.2 Proposed Presentation Context Table

Presentation Context Table – Proposed					
Abstract Syntax		Transfer Syntax		Role	Extended Negotiation
Name	UID	Name List	UID List		
Basic Grayscale Print Management Meta SOP Class	1.2.840.10008.5.1.1.9	Implicit VR Little Endian	1.2.840.10008.1.2	SCU	None
Basic Color Print Management Meta SOP Class	1.2.840.10008.5.1.1.18	Implicit VR Little Endian	1.2.840.10008.1.2	SCU	None

4.3.1.1.7.2.1 SOP Specific DICOM Conformance Statement for Print Management SOP Classes

The DICOM Print SCU AE initiates one association with the selected REMOTE DICOM Printer. The DICOM Print SCU AE will not open another association while the current one is active.

The Basic Grayscale Print Management Meta SOP Class and the Color Grayscale Print Management Meta SOP Class are never negotiated simultaneously.

For each of the supported Print Management SOP and Meta SOP Classes, the optional attributes and service elements supported, the valid range of values for mandatory and optional attributes, and the status code behavior are described in Annex.

4.4 COMMUNICATION PROFILES

4.4.1 Supported Communication Stacks (PS 3.8, PS 3.9)

DICOM Upper Layer (PS 3.8) is supported using TCP/IP.

4.4.2 OSI Stack

OSI stack not supported

4.4.3 TCP/IP Stack

The TCP/IP stack is inherited from a UNIX Operating System.

4.4.3.1 API

Not applicable to this product.

4.4.3.2 Physical Media Support

DICOM is indifferent to the Physical medium over which TCP/IP executes (e.g. Ethernet V2.0, IEEE 802.3, ATM, FDDI)

For more information about the Physical Media available on Advantage Workstation 4.2, please refer to the Product Data Sheet.

4.4.4 Point-to-Point Stack

A 50-pin ACR-NEMA connection is not applicable to this product.

4.5 EXTENSIONS / SPECIALIZATIONS / PRIVATIZATIONS

4.5.1 Standard Extended /Specialized/Private SOP Classes

No Standard Extended, no Specialized, no Private SOP Classes are managed by this application.

4.5.2 Private Transfer Syntaxes

No Private Transfer Syntaxes are managed by this product.

4.5.3 CONFIGURATION

4.5.3.1 AE Title/Presentation Address Mapping

The local DICOM Print SCU AE Title is: "PR_Hostname" where Hostname is the system hostname defined at installation. The default AET PR_Hostname can be overwritten by setting a new AET in the file ~sdc/app-defaults/dicom_print/dprint.cfg.

4.5.3.2 Configurable Parameters

For this AE (local) the following fields are configurable in the file:

~sdc/app-defaults/dicom_print/dprint.cfg:

- Local AE Title

Note: The Local IP address and the local IP netmask are the ones of the workstation

Note: No local Port Number is defined because the product is never responding to an association request.

The following fields are configurable for every remote DICOM AE:

- Remote AE Title
- Remote IP Address
- Listening TCP/IP Port Number

The Print Manager application allow the user to add, delete, or update the Remote DICOM Printers parameters described above.

A default router IP Address for all DICOM remote nodes (including printers, Storage SCP Workstations...) can be configured as well as some specific routes.

The following fields are configurable:

- Message report timeout (default=60s)
- Event report timeout (default=3600s)
- Maximum PDU Length

The GE Field Engineer can update this configuration.

Only one association can be performed at a time by this implementation.

4.6 SUPPORT OF EXTENDED CHARACTER SETS

The Advantage Workstation 4.2 will support only the ISO_IR 100 (ISO 8859-1:1987 Latin alphabet N 1. supplementary set) as extended character sets.

5. PRINT MANAGEMENT SOP CLASS DEFINITION

5.1 INTRODUCTION

This section of the DICOM Conformance Statement specifies the supported Print Management SOP and Meta SOP Classes, the optional attributes and service elements supported, the valid range of values for mandatory and optional attributes, and the status code behavior.

This section contains:

5.2.1- Basic Film Session SOP Class

5.2.2 - Basic Film Box SOP Class

5.2.3 - Image Box SOP Classes

5.2.4 - Printer SOP Class

5.2.5 - Print Job SOP Class

5.2.6- Basic Annotation Box SOP Class

5.2.7 - Image Overlay Box SOP Class

5.2 PRINT MANAGEMENT SOP CLASS DEFINITIONS

5.2.1 Basic Film Session SOP Class

The DICOM Print SCU AE supports the N-CREATE DIMSE Service Element for the Basic Film Session SOP Class.

- The N-CREATE DIMSE Service element sent by the DICOM Print SCU AE requests the Remote DICOM Print SCP to create an instance of Basic Film Session.

5.2.1.1 IOD Description

5.2.1.1.1 IOD modules

Module	Reference	Module Description
SOP Common		Contains SOP Common information
Basic Film Session Presentation Module	5.2.1.1.2	Contains Film Session presentations information
Basic Film Session Relationship	5.2.1.1.3	References to related SOPs

5.2.1.1.2 Basic Film Session Presentation Module

Attribute name	Tag	Attribute Description
Number of Copies	(2000,0010)	1 to 10, depending of print manager configuration. Default value: 1
Print Priority	(2000,0020)	HIGH or MED or LOW depending of default configuration Default value: LOW
Medium Type	(2000,0030)	PAPER or CLEAR FILM or BLUE FILM depending of configuration of associated Remote DICOM printer Default value: BLUE FILM
Film Destination	(2000,0040)	MAGAZINE or PROCESSOR depending of configuration of associated Remote DICOM printer Default value:PROCESSOR
Film Session Label	(2000,0050)	Configurable by the Field Engineer Not sent by default

Note: Default configuration can be modified during the installation of the Advantage Workstation 4.2.

5.2.1.1.3 Basic Film Session Relationship Module

Attribute Name	Tag	Attribute Description
Referenced Film Box Sequence	(2000,0500)	Empty
>Referenced SOP Class UID	(0008,1150)	Empty
>Referenced SOP Instance UID	(0008,1155)	Empty

5.2.1.2 DIMSE Service Group

DIMSE Service Element	Usage SCU
N-CREATE	M
N-SET	Not used
N-DELETE	Not used
N-ACTION	Not used

5.2.1.2.1 N-CREATE

5.2.1.2.1.1 Attributes

Attribute Name	Tag	Usage SCU
Number of Copies	(2000,0010)	Used
Print Priority	(2000,0020)	Used
Medium Type	(2000,0030)	Used
Film Destination	(2000,0040)	Used
Film Session Label	(2000,0050)	Used, not sent if empty
Memory Allocation	(2000,0060)	Not Used

5.2.1.2.1.2 Status

Service Status	Status Codes	Further Meaning	Application Behavior When receiving Status Codes
Warning	B600	Memory allocation not supported	Association is aborted
Success	0000	Film session successfully created	Next step describe in the sequencing of Real-World Activities paragraph is performed

5.2.1.2.1.3 Behavior

No specific behavior

5.2.1.2.2 N-SET

This service is not used.

5.2.1.2.3 N-DELETE

This service is not used.

5.2.1.2.4 N-ACTION

This service is not used.

5.2.2 Basic Film Box SOP Class

The DICOM Print SCU AE supports the following DIMSE Service Element for the Basic Film Box SOP Class.

- The N-CREATE DIMSE Service element sent by the DICOM Print SCU AE requests the Remote DICOM Print SCP to create an instance of Basic Film Box
- The N-ACTION DIMSE Service element sent by the DICOM Print SCU AE requests the Remote DICOM Print SCP to print the Basic Film Box onto the hard copy printer.
- The N-DELETE DIMSE Service element sent by the DICOM Print SCU AE requests the Remote DICOM Print SCP to release the Basic Film Box instance.

5.2.2.1 IOD Description

5.2.2.1.1 IOD modules

Module	Reference	Module Description
SOP Common		Contains SOP Common information
Basic Film Box Presentation Module	5.2.2.1.2	Contains Film Box presentation information
Basic Film Box Relationship	5.2.2.1.3	References to related SOPs

5.2.2.1.2 Basic Film Box Presentation Module

Attribute Name	Tag	Attribute Description
Image Display Format	(2010,0010)	STANDARD\C,R [C 1 to 5] and [R 1 to 4] SLIDE SUPERSLIDE Default value: STANDARD (Depending of configuration of associated remote DICOM printer).
Annotation Display Format ID	(2010,0030)	Not sent.
Film Orientation	(2010,0040)	PORTRAIT LANDSCAPE Default value: PORTRAIT (Depending of configuration of associated remote DICOM printer).
Film Size ID	(2010,0050)	8INX10IN 8_5INX11IN(Letter) 10INX12IN 10INX14IN 11INX14IN 11INX17IN 14INX14IN 14INX17IN 24CMX24CM 24CMX30CM A4(210mmx297mm) A3(297mm x 420mm) (Depending of configuration of associated remote DICOM printer). Default value: First selection when declaring printer.
Magnification Type	(2010,0060)	One of the following defined term is sent: REPLICATE BILINEAR CUBIC NONE Default value: CUBIC (Depending of configuration set by user when declaring the printer).
Smoothing Type	(2010,0080)	Sent if Magnification type = CUBIC Default value: "" (Depending of configuration set by user when declaring the printer).
Border density	(2010,0100)	BLACK or WHITE depending of default configuration. Default value: BLACK

Empty Image Density	(2010,0110)	BLACK or WHITE depending of default configuration. Default value: ""
Min Density	(2010,0120)	-1 by default or set to positive integer. Default value depends of configuration set by user when declaring the printer
Max Density	(2010,0130)	-1 by default or set to positive integer. Default value depends of configuration set by user when declaring the printer
Trim	(2010,0140)	Set to YES or NO according to value set by user when declaring the printer. Default value: NO
Configuration Information	(2010,0150)	Empty by default or set to a value defined when declaring the printer.
Illumination	(2010,015E)	Not sent.
Reflected Ambient Light	(2010,0160)	Not sent.
Requested Resolution ID	(2020,0050)	Not sent.
Referenced Presentation LUT Sequence	(2050,0500)	Not sent.

5.2.2.1.3 Basic Film Box Relationship Module

Attribute Name	Tag	Attribute Description
Referenced Film Session Sequence	(2010,0500)	Empty
>Referenced SOP Class UID	(0008,1150)	Empty
>Referenced SOP Instance UID	(0008,1155)	Empty
Referenced Image Box Sequence	(2010,0510)	Empty
>Referenced SOP Class UID	(0008,1150)	Empty
>Referenced SOP Instance UID	(0008,1155)	Empty
Referenced Basic Annotation Box Sequence	(2010,0520)	Empty
>Referenced SOP Class UID	(0008,1150)	Empty
>Referenced SOP Instance UID	(0008,1155)	Empty

5.2.2.2 DIMSE Service Group

DIMSE Service Element	Usage SCU
N-CREATE	M
N-ACTION	M
N-DELETE	Used

5.2.2.2.1 N-CREATE

5.2.2.2.1.1 Attributes

Attribute Name	Tag	Usage SCU
Image Display Format	(2010,0010)	M
Referenced Film Session Sequence	(2010,0500)	M
>Referenced SOP Class UID	(0008,1150)	M
>Referenced SOP Instance UID	(0008,1155)	M
Referenced Image Box Sequence	(2010,0510)	Not used
>Referenced SOP Class UID	(0008,1150)	Not used
>Referenced SOP Instance UID	(0008,1155)	Not used
Referenced Basic Annotation Box Sequence	(2010,0520)	Not used
>Referenced SOP Class UID	(0008,1150)	Not used
>Referenced SOP Instance UID	(0008,1155)	Not used
Film Orientation	(2010,0040)	Used
Film Size ID	(2010,0050)	Used
Magnification Type	(2010,0060)	Used
Max Density	(2010,0130)	Used. Not sent if -1
Configuration Information	(2010,0150)	<u>Used</u> . Not sent if empty
Annotation Display Format ID	(2010,0030)	Not used
Smoothing Type	(2010,0080)	Used. Not sent if magnification different from CUBIC
Border Density	(2010,0100)	Used Not sent if empty
Empty Image Density	(2010,0110)	Used Not sent if empty
Min Density	(2010,0120)	Used Not sent if -1
Trim	(2010,0140)	Used Not sent if empty

5.2.2.2.1.2 Status

There are no specific status codes. Warning B605 not taken into account (min/max density outside of printer range)

5.2.2.2.1.3 Behavior

There is no specific behavior.

5.2.2.2.2 N-DELETE

5.2.2.2.2.1 Behavior

The SCU uses the N-DELETE to request the SCP to delete the Basic Film Box SOP Instance hierarchy.

5.2.2.2.3 N-ACTION

N-ACTION is used to print the current film of the film session.

5.2.2.2.3.1 Attributes

Action Type Name	Action Type ID	Attribute	Tag	Usage SCU
Print	1	Referenced Print Job Sequence	(2100,0500)	Not used
		>Referenced SOP Class UID	(0008,1150)	Not used
		>Referenced SOP Instance UID	(0008,1155)	Not used

5.2.2.2.3.2 Status

Service Status	Status Codes	Further Meaning	Application Behavior When receiving Status Codes
Success	0000	Film accepted for printing.	Next step describe in the sequencing of Real-World Activities paragraph is performed
Warning	B603	Film Box SOP Instance hierarchy does not contain Image Box SOP Instances (empty page)	This case should not happen. This warning is considered as an error. Association is aborted.
Warning	B604	Image size is larger than image box size.	This case should not happen. Image will be demagnified by the printer.
Failure	C602	Unable to create Print Job SOP Instance; print queue is full	Appropriate message is returned to the user. Association is aborted.
	C604	Image position collision: multiple images assigned to single image position	Appropriate message is returned to the user. Association is aborted.
	C603	Image size is larger than image box size (by using the specified magnification value)	Appropriate message is returned to the user. Association is aborted.

5.2.2.2.3.3 Behavior

SCU uses the N-ACTION to request the SCP to print one or more copies of a single film of the film session.

5.2.3 Image Box SOP Classes

5.2.3.1 Basic Grayscale Image Box SOP Class

The DICOM Print SCU AE supports the following DIMSE Service Element for the Basic Grayscale Image Box SOP Class.

- The N-SET DIMSE Service element sent by the DICOM Print SCU AE requests the Remote DICOM Print SCP to set the attributes of the Basic Grayscale Image Box Instance.

5.2.3.1.1 IOD description

5.2.3.1.1.1 IOD modules

Module	Reference	Module Description
SOP Common		Contains SOP Common information
Image Box Pixel Presentation Module	5.2.3.1.1.2	Contains Image Box presentation information
Image Box Relationship Module	5.2.3.1.1.3	References to related SOPs

5.2.3.1.1.2 Image Box Pixel Presentation Module

Attribute Name	Tag	Attribute Description
Image Position	(2020,0010)	Value depends of the position within the Film box (1-N)
Polarity	(2020,0020)	NORMAL = pixels shall be printed as specified by the Photometric Interpretation (0028,0004) REVERSE = pixels shall be printed with the opposite polarity as specified by the Photometric Interpretation (0028,0004) Default value: NORMAL (Depending of default configuration)
Magnification Type	(2010,0060)	Same value as defined in the Film box
Smoothing Type	(2010,0080)	Same value as defined in the Film box
Configuration Information	(2010,0150)	Same value as defined in the Film Box.
Requested Image Size	(2020,0030)	Not sent
Requested Decimate/Crop Behavior	(2020,0040)	Not sent
Basic Grayscale Image Sequence	(2020,0110)	This sequence is always included if the Image Box is a Basic Grayscale Image Box
>Samples Per Pixel	(0028,0002)	1
>Photometric Interpretation	(0028,0004)	MONOCHROME1 or MONOCHROME2 depending of default configuration. Default value: MONOCHROME2
>Rows	(0028,0010)	Original image height
>Columns	(0028,0011)	Oiginal image width
>Pixel Aspect Ratio	(0028,0034)	1\1
>Bits Allocated	(0028,0100)	Depends on the image pixel depth (8 or 16)
>Bits Stored	(0028,0101)	Depends on the image pixel depth (8, 12 bits)
>High Bit	(0028,0102)	Depends on the image pixel depth (7, 11)
>Pixel Representation	(0028,0103)	0 (Unsigned Integer)
>Pixel Data	(7FE0,0010)	
Original Image Sequence	(2130,00C0)	Not sent

5.2.3.1.1.3 Image Box Relationship Module

Attribute Name	Tag	Attribute Description
Referenced Image Sequence	(0008,1140)	Not used
>Referenced SOP Class UID	(0008,1150)	Not used
>Referenced SOP Instance UID	(0008,1155)	Not used
>Referenced Frame Number	(0008,1160)	Not used
Referenced Image Overlay Box Sequence	(2020,0130)	Not used
>Referenced SOP Class UID	(0008,1150)	Not used
>Referenced SOP Instance UID	(0008,1155)	Not used
>Referenced Frame Number	(0008,1160)	Not used
Referenced VOI LUT Sequence	(2020,0140)	Not used
>Referenced SOP Class UID	(0008,1150)	Not used
>Referenced SOP Instance UID	(0008,1155)	Not used

5.2.3.1.2 DIMSE Service Group

DIMSE Service Element	Usage SCU
N-SET	M

5.2.3.1.2.1 N-SET

5.2.3.1.2.1.1 Attributes

Attribute Name	Tag	Usage SCU
Image Position	(2020,0010)	M
Preformatted Grayscale Image Sequence	(2020,0110)	M
>Samples Per Pixel	(0028,0002)	M
>Photometric Interpretation	(0028,0004)	M
>Rows	(0028,0010)	M
>Columns	(0028,0011)	M
>Pixel Aspect Ratio	(0028,0034)	1\1
>Bits Allocated	(0028,0100)	M
>Bits Stored	(0028,0101)	M
>High Bit	(0028,0102)	M
>Pixel Representation	(0028,0103)	M
>Pixel Data	(7FE0,0010)	M
Polarity	(2020,0020)	Used
Referenced Overlay Sequence	(0008,1130)	Not used
>SOP Class UID	(0008,1150)	Not used
>SOP Instance UID	(0008,1155)	Not used
Magnification Type	(2010,0060)	Used
Smoothing Type	(2010,0080)	Used, not sent if magnification is different of CUBIC
Configuration Information	(2010,0150)	Used, not sent if empty
Requested Image Size	(2020,0030)	Not used

5.2.3.1.2.1.2 Status

Service Status	Status Codes	Further Meaning	Application Behavior When receiving Status Codes
Failure	C605	Insufficient memory in printer to store the image	Appropriate message is returned to the user. Association is aborted.

5.2.3.1.2.1.3 Behavior

There is no specific behavior.

5.2.3.2 Basic Color Image Box SOP Class

The DICOM Print SCU AE supports the following DIMSE Service Element for the Color Image Box SOP Class.

- The N-SET DIMSE Service element sent by the DICOM Print SCU AE requests the Remote DICOM Print SCP to set the attributes of the Color Image Box Instance.

5.2.3.2.1 IOD description

5.2.3.2.1.1 IOD modules

Module	Reference	Module Description
SOP Common		Contains SOP Common information
Image Box Pixel Presentation Module	5.2.3.1.1.2	Contains Image Box presentation information
Image Box Relationship Module	5.2.3.1.1.3	References to related SOPs

5.2.3.2.1.2 Image Box Pixel Presentation Module

Attribute Name	Tag	Attribute Description
Image Position	(2020,0010)	Value depends of the position within the Film box (1-N)
Polarity	(2020,0020)	NORMAL
Magnification Type	(2010,0060)	Same value as defined in the Film box
Smoothing Type	(2010,0080)	Same value as defined in the Film box
Configuration Information	(2010,0150)	Same value as defined in the Film Box.

Requested Image Size	(2020,0030)	Not sent
Requested Decimate/Crop Behavior	(2020,0040)	Not sent
Basic Color Image Sequence	(2020,0111)	This sequence is always included if the Image Box is a Basic Color Image Box
>Samples Per Pixel	(0028,0002)	3
>Photometric Interpretation	(0028,0004)	RGB
>Planar Configuration	(0028,0006)	1
>Rows	(0028,0010)	Original image height
>Columns	(0028,0011)	Original image width
>Pixel Aspect Ratio	(0028,0034)	1\1
>Bits Allocated	(0028,0100)	8
>Bits Stored	(0028,0101)	8
>High Bit	(0028,0102)	7
>Pixel Representation	(0028,0103)	0
>Pixel Data	(7FE0,0010)	
Original Image Sequence	(2130,00C0)	Not sent

5.2.3.2.1.3 Image Box Relationship Module

Attribute Name	Tag	Attribute Description
Referenced Image Sequence	(0008,1140)	Not used
>Referenced SOP Class UID	(0008,1150)	Not used
>Referenced SOP Instance UID	(0008,1155)	Not used
>Referenced Frame Number	(0008,1160)	Not used
Referenced Image Overlay Box Sequence	(2020,0130)	Not used
>Referenced SOP Class UID	(0008,1150)	Not used
>Referenced SOP Instance UID	(0008,1155)	Not used
>Referenced Frame Number	(0008,1160)	Not used
Referenced VOI LUT Sequence	(2020,0140)	Not used
>Referenced SOP Class UID	(0008,1150)	Not used
>Referenced SOP Instance UID	(0008,1155)	Not used

5.2.3.2.2 DIMSE Service Group

DIMSE Service Element	Usage SCU
N-SET	M

5.2.3.2.2.1 N-SET

5.2.3.2.2.1.1 Attributes

Attribute Name	Tag	Usage SCU
Image Position	(2020,0010)	M
Preformatted Color Image Sequence	(2020,0111)	M
>Samples Per Pixel	(0028,0002)	M
>Photometric Interpretation	(0028,0004)	M
>Planar Configuration	(0028,0006)	Used
>Rows	(0028,0010)	M
>Columns	(0028,0011)	M
>Pixel Aspect Ratio	(0028,0034)	1\1
>Bits Allocated	(0028,0100)	M
>Bits Stored	(0028,0101)	M
>High Bit	(0028,0102)	M
>Pixel Representation	(0028,0103)	M
>Pixel Data	(7FE0,0010)	M
Polarity	(2020,0020)	Used
Referenced Overlay Sequence	(0008,1130)	Not used
>SOP Class UID	(0008,1150)	Not used
>SOP Instance UID	(0008,1155)	Not used
Magnification Type	(2010,0060)	Used
Smoothing Type	(2010,0080)	Used. Not sent if magnification is different of CUBIC
Configuration Information	(2010,0150)	Used, not sent if empty
Requested Image Size	(2020,0030)	Not used

5.2.3.2.2.1.2 Status

Service Status	Status Codes	Further Meaning	Application Behavior When receiving Status Codes
Failure	C605	Insufficient memory in printer to store the image	Appropriate message is returned to the user. Association is aborted.

5.2.3.2.2.1.3 Behavior

There is no specific behavior.

5.2.4 Printer SOP Class

The DICOM Print SCU AE supports the following DIMSE Service Element for the Basic Printer SOP Class.

The N-EVENT_REPORT DIMSE Service element sent by the DICOM Print SCP to the local DICOM Print SCU AE. The DICOM Print SCU handles the Printer Status and Printer Status Info fields. All other received data are ignored.

The N-GET DIMSE Service element sent by the DICOM Print SCU AE requests the Remote DICOM Print SCP to give information on the Remote DICOM Printer.

5.2.4.1 IOD Description

5.2.4.1.1 IOD modules

Module	Reference	Module Description
SOP Common		Contains SOP Common information
Printer Module	5.2.4.1.2	Contains status information to monitor the printer

5.2.4.1.2 Printer Module

Attribute Name	Tag	Attribute Description
Printer Status	(2110,0010)	The behaviour defined for the following term NORMAL: Association goes on. FAILURE: Association is aborted. WARNING: Association is not released
Printer Status Info	(2110,0020)	Printer return value
Printer Name	(2110,0030)	Printer return value
Manufacturer	(0008,0070)	Printer return value if not empty
Manufacturer Model Name	(0008,1090)	Printer return value if not empty
Device Serial Number	(0018,1000)	Printer return value if not empty
Software Versions	(0018,1020)	Printer return value if not empty
Date Of Last Calibration	(0018,1200)	Printer return value if not empty
Time Of Last Calibration	(0018,1201)	Printer return value if not empty

5.2.4.2 DIMSE Service Group

DIMSE Service Element	Usage SCU
N-EVENT-REPORT	M
N-GET	U

5.2.4.2.1 N-EVENT-REPORT

5.2.4.2.1.1 Attributes

Event Type Name	Event Type ID	Attribute	Tag	Usage SCU
Normal	1	Printer Name	(2110,0030)	Used
		Printer Status Info	(2110,0020)	Used
Warning	2	Printer Name	(2110,0030)	Used
		Printer Status Info	(2110,0020)	Used
Failure	3	Printer Name	(2110,0030)	Used
		Printer Status Info	(2110,0020)	Used

5.2.4.2.1.2 Behavior

On reception Failure status, the Print SCU aborts the association.

If Printer Status is FAILURE

Signal print failure to the user, association is aborted

Else If Printer Status is WARNING

Signal print warning to the user

Else

Signal print success to the user

5.2.4.2.2 N-GET

5.2.4.2.2.1 Attributes

Attribute name	Tag	Usage SCU
Printer Status	(2110,0010)	Used
Printer Status Info	(2110,0020)	Used
Printer Name	(2110,0030)	Used if return by he printer
Manufacturer	(0008,0070)	Used if return by he printer
Manufacturer Model Name	(0008,1090)	Used if return by he printer
Device Serial Number	(0018,1000)	Used if return by he printer
Software Versions	(0018,1020)	Used if return by he printer
Date Last Calibration	(0018,1200)	Used if return by he printer
Last Calibration	(0018,1201)	Used if return by he printer

5.2.4.2.2.2 Behavior

If Printer Status is FAILURE

Signal print failure to the user, association aborted

Else If Printer Status is WARNING

Signal print warning to the user

Else

Signal print success to the user

5.2.5 Print Job SOP Class

This SOP Class is not supported by this implementation.

5.2.6 Basic Annotation Box SOP Class

This SOP Class is not supported by this implementation.

5.2.7 Image Overlay Box SOP Class

This SOP Class is not supported by this implementation.

6. SC INFORMATION OBJECT IMPLEMENTATION

6.1 INTRODUCTION

This section specifies the use of the DICOM SC Image IOD to represent the information included in SC images produced by this implementation. Corresponding attributes are conveyed using the module construct. The contents of this section are:

6.2- SC Entity-Relationship Model

6.3- SC-IOD MODULE TABLE

6.4- SC-INFORMATION MODULE DEFINITIONS

6.5- SC-PRIVate data dictionary

6.2 SC ENTITY-RELATIONSHIP MODEL

The Entity-Relationship diagram for the SC Image interoperability schema is shown in **Illustration 7.2.1**. In this figure, the following diagrammatic convention is established to represent the information organization:

- Each entity is represented by a rectangular box
- Each relationship is represented by a diamond shaped box.
- The fact that a relationship exists between two entities is depicted by lines connecting the corresponding entity boxes to the relationship boxes.

The relationships are fully defined with the maximum number of possible entities in the relationship shown. In other words, the relationship between Series and Image can have up to **n** Images per Series, but the Patient to Study relationship has 1 Study for each Patient (a Patient can have more than one Study on the system, however each Study will contain all of the information pertaining to that Patient).

ILLUSTRATION 6.2-1
SC IMAGE ENTITY RELATIONSHIP DIAGRAM

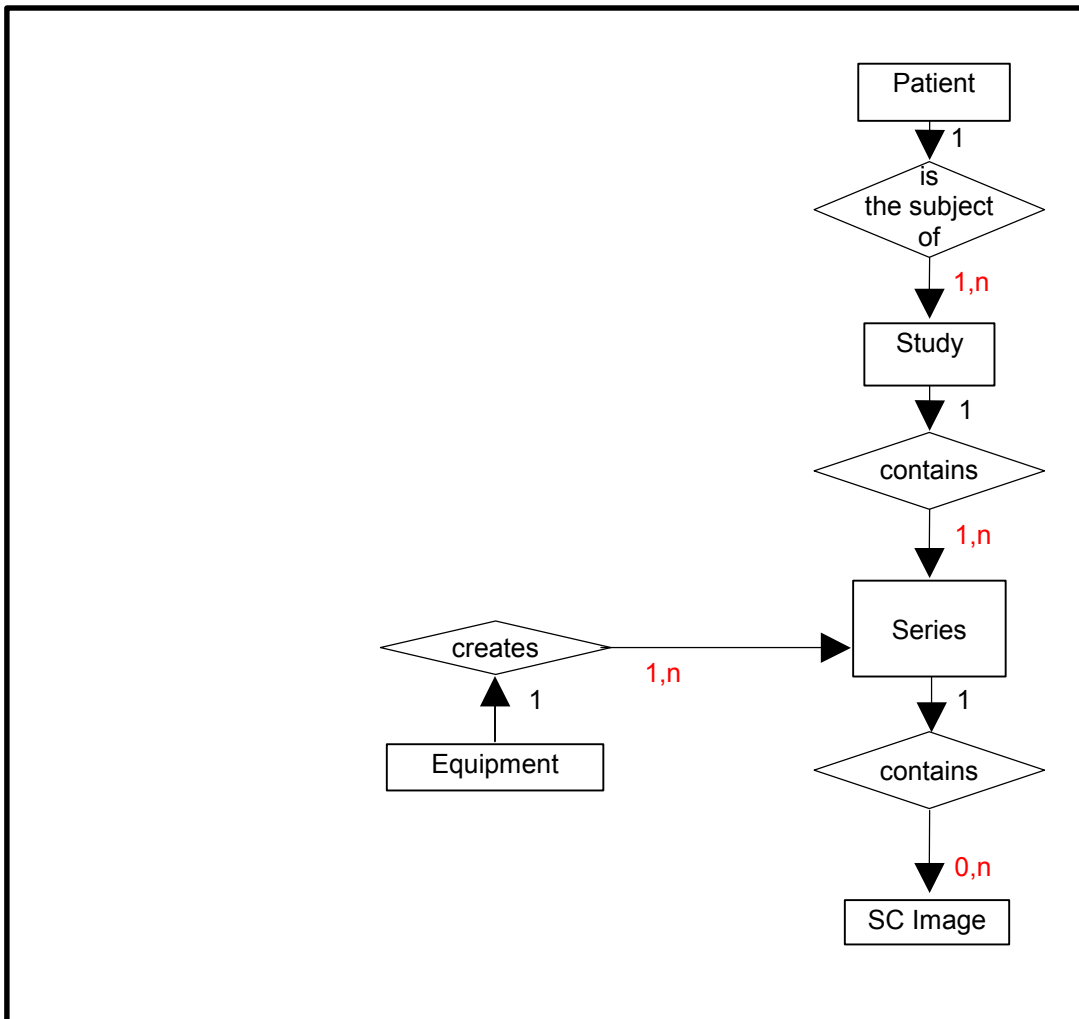

6.2.1 ENTITY DESCRIPTIONS

Please refer to DICOM Standard Part 3 (Information Object Definitions) for a description of each of the entities contained within the SC Information Object.

6.2.2 Advantage Workstation 4.2 Mapping of DICOM entities

TABLE 6.2-1
MAPPING OF DICOM ENTITIES TO ADVANTAGE WORKSTATION 4.2 ENTITIES

DICOM	Advantage Workstation 4.2 Entity
Patient	Patient
Study	Exam
Series	Series
Image	Image

6.3 SC-IOD MODULE TABLE

Within an entity of the DICOM SC IOD, attributes are grouped into related set of attributes. A set of related attributes is termed a module. A module facilitates the understanding of the

semantics concerning the attributes and how the attributes are related with each other. A module grouping does not infer any encoding of information into datasets.

Table 6.3-1 identifies the defined modules within the entities that comprise the DICOM SC IOD. The modules are identified by their Module Name.

See DICOM Part 3 for a complete definition of the entities, modules, and attributes.

TABLE 6.3-1
SC IMAGE IOD MODULES

Entity Name	Module Name	Reference
Patient	Patient	6.4.1.1
Study	General Study	6.4.2.1
	Patient Study	6.4.2.2
Series	General Series	6.4.3.1
	General Equipment	6.4.4.1
Equipment	SC Equipment	6.4.9.1
	General Image	6.4.5.1
Image	Image Pixel	6.4.5.2
	SC Image	6.4.9.2
	Overlay Plane	6.4.5.2.1
	Modality LUT	6.4.7.2
	VOI LUT	6.4.7.1
	SOP Common	6.4.8.1

6.4 SC-INFORMATION MODULE DEFINITIONS

Please refer to DICOM Standard Part 3 (Information Object Definitions) for a description of each of the entities and modules contained within the SC Information Object.

The following modules are included to convey Enumerated Values, Defined Terms, and Optional Attributes supported. Type 1 & Type 2 Attributes are also included for completeness and to define what values they may take and where these values are obtained from. It should be noted that they are the same ones as defined in the DICOM Standard Part 3 (Information Object Definitions).

6.4.1 Common Patient Entity Modules

6.4.1.1 Patient Module

This section specifies the Attributes of the Patient that describe and identify the Patient who is the subject of a diagnostic Study. This Module contains Attributes of the patient that are needed for diagnostic interpretation of the Image and are common for all studies performed on the patient.

A Screen Save image is a DICOM Secondary Capture generated by Advantage Workstation 4.2.

**TABLE 6.4-1
PATIENT MODULE ATTRIBUTES**

Attribute Name	Tag	Type	Attribute Description
Patient's Name	(0010,0010)	2	<u>Screen Save image</u> Original <u>Filmer</u> Original if No Mix Mode or Mix Mode = Study User defined if Mix Mode = Patient
Patient ID	(0010,0020)	2	<u>Screen Save image</u> Original <u>Filmer</u> Original if No Mix Mode or Mix Mode = Study Function of pid and time if Mix Mode = Patient
Patient's Birth Date	(0010,0030)	2	<u>Screen Save image</u> Original <u>Filmer</u> Original if No Mix Mode or Mix Mode = Study Empty if Mix Mode = Patient
Patient's Sex	(0010,0040)	2	<u>Screen Save image</u> Original <u>Filmer</u> Original if No Mix Mode or Mix Mode = Study Empty if Mix Mode = Patient

6.4.2 Common Study Entity Modules

The following Study IE Modules are common to all Composite Image IODs, which reference the Study IE. These Modules contain Attributes of the patient and study that are needed for diagnostic interpretation of the image.

6.4.2.1 General Study Module

This section specifies the Attributes, which describe and identify the Study performed upon the Patient.

TABLE 6.4-2
GENERAL STUDY MODULE ATTRIBUTES

Attribute Name	Tag	Type	Notes
Study Instance UID	(0020,000D)	1	<u>Screen Save image</u> Original <u>Filmer</u> Original if No Mix Mode Generated if Mix Mode = Patient or Mix Mode = Study
Study Date	(0008,0020)	2	<u>Screen Save image</u> Original (Empty if does not exist) <u>Filmer</u> Original (Empty if does not exist) if No Mix Mode Empty if Mix Mode = Patient or Mix Mode = Study
Study Time	(0008,0030)	2	<u>Screen Save image</u> Original (Empty if does not exist) <u>Filmer</u> Original (Empty if does not exist) if No Mix Mode Empty if Mix Mode = Patient or Mix Mode = Study
Referring Physician's Name	(0008,0090)	2	<u>Screen Save image</u> Original (Empty if does not exist) <u>Filmer</u> Original (Empty if does not exist) if No Mix Mode Empty if Mix Mode = Patient or Mix Mode = Study
Study ID	(0020,0010)	2	<u>Screen Save image</u> Original (Empty if does not exist) <u>Filmer</u> Original (Empty if does not exist) if No Mix Mode Empty if Mix Mode = Patient or Mix Mode = Study
Accession Number	(0008,0050)	2	<u>Screen Save image</u> Original (Empty if does not exist) <u>Filmer</u> Original (Empty if does not exist) if No Mix Mode Empty if Mix Mode = Patient or Mix Mode = Study

Study Description	(0008,1030)	3	<u>Screen Save image</u> Original (Empty if does not exist) <u>Filmer</u> Original (Empty if does not exist) if No Mix Mode User defined if Mix Mode = Patient or Mix Mode = Study
-------------------	-------------	---	--

6.4.2.2 Patient Study Module

This section defines Attributes that provide information about the Patient at the time the Study was performed.

**TABLE 6.4-3
PATIENT STUDY MODULE ATTRIBUTES**

Attribute Name	Tag	Type	Attribute Description
Patient's Age	(0010,1010)	3	<u>Screen Save image</u> Original <u>Filmer</u> Original if No Mix Mode Not present if Mix Mode = Patient or Mix Mode = Study
Patient's Size	(0010,1020)	3	<u>Screen Save image</u> Original <u>Filmer</u> Original if No Mix Mode Not present if Mix Mode = Patient or Mix Mode = Study
Patient's Weight	(0010,1030)	3	<u>Screen Save image</u> Original <u>Filmer</u> Original if No Mix Mode Not present if Mix Mode = Patient or Mix Mode = Study

6.4.3 Common Series Entity Modules

The following Series IE Modules are common to all Composite Image IODs, which reference the Series IE.

6.4.3.1 General Series Module

This section specifies the Attributes that identify and describe general information about the Series within a Study.

TABLE 6.4-4
GENERAL SERIES MODULE ATTRIBUTES

Attribute Name	Tag	Type	Attribute Description
Modality	(0008,0060)	1	<u>Screen Save image</u> Original <u>Filmer</u> OT (Other)
Series Instance UID	(0020,000E)	1	Generated
Series Number	(0020,0011)	2	Generated
Laterality	(0020,0060)	2C	<u>Screen Save image</u> Original <u>Filmer</u> Original if the generated Screen Save is composed of one original image Not Present if the generated Screen Save is a composition of multiple images
Series Description	(0008,103E)	3	<u>Screen Save image</u> Screen Save <u>Filmer</u> AW Electronic film
Operator's Name	(0008,1070)	3	Name of the current user logged on the station
Patient Position	(0018,5100)	2C	<u>Screen Save image</u> Original <u>Filmer</u> Original if the generated Screen Save is composed of one original image Not Present if the generated Screen Save is a composition of multiple images

6.4.4 Common Equipment Entity Modules

The following Equipment IE Module is common to all Composite Image IODs that reference the Equipment IE.

6.4.4.1 General Equipment Module

This section specifies the Attributes that identify and describe the piece of equipment that produced a Series of Images.

TABLE 6.4-5
GENERAL EQUIPMENT MODULE ATTRIBUTES

Attribute Name	Tag	Type	Attribute Description
Manufacturer	(0008,0070)	2	Derived from original image
Institution Name	(0008,0080)	3	<u>Screen Save image</u> Derived from original image <u>Filmer</u> Derived from original image if No Mix Mode Empty if Mix Mode = Patient or Mix Mode = Study
Institution Address	(0008,0081)	3	<u>Screen Save image</u> Derived from original image <u>Filmer</u> Derived from original image if No Mix Mode Empty if Mix Mode = Patient or Mix Mode = Study
Station Name	(0008,1010)	3	Derived from original image
Manufacturer's Model Name	(0008,1090)	3	Derived from original image
Software Versions	(0018,1020)	3	Derived from original image

6.4.4.1.1 General Equipment Attribute Descriptions

6.4.4.1.1.1 Pixel Padding Value

Not used

6.4.5 Common Image Entity Modules

The following Image IE Modules are common to all Composite Image IODs that reference the Image IE.

6.4.5.1 General Image Module

This section specifies the Attributes that identify and describe an image within a particular series.

TABLE 6.4-6
GENERAL IMAGE MODULE ATTRIBUTES

Attribute Name	Tag	Type	Attribute Description
Instance Number	(0020,0013)	2	Generated
Patient Orientation	(0020,0020)	2C	See 6.4.5.1.1.1.
Content Date	(0008,0023)	2C	Derived from original image
Content Time	(0008,0033)	2C	Derived from original image
Image Type	(0008,0008)	3	See 6.4.5.1.1.2.
Burned In Annotation	(0028, 0301)	3	YES

6.4.5.1.1 General Image Attribute Descriptions

6.4.5.1.1.1 Patient Orientation

Derived from original if Screen Save.

Empty if Filmer

6.4.5.1.1.2 Image Type

If a third value is defined in the original DICOM Image Type, then the image type is set to:

DERIVED\SECONDARY\<<Originaltype>\SCREEN SAVE

If no third value is defined in the original DICOM Image Type, then the image type is set to:

DERIVED\SECONDARY\SCREEN SAVE

6.4.5.1.1.3 Derivation Description and Source Image Sequence

This sequence is not encoded

6.4.5.2 Image Pixel Module

This section specifies the Attributes that describe the pixel data of the image.

**TABLE 6.4-7
IMAGE PIXEL MODULE ATTRIBUTES**

Attribute Name	Tag	Type	Attribute Description
Samples per Pixel	(0028,0002)	1	1 - if image is displayed in levels of gray 3 - if image is displayed in full colors
Photometric Interpretation	(0028,0004)	1	Set to MONOCHROME1 if the pixels of the image were inverted and the element (0x0028, 0x0002) is set to the value 1. Set to MONOCHROME2 if the pixels of the image were inverted and the element (0x0028, 0x0002) is set to the value 1. Set to RGB If the element (0x0028, 0x0002) is set to the value of 3.
Planar Configuration	(0028, 0006)	1C	0, if element (0x0028, 0x0002) is 3 Not present otherwise
Pixel Aspect Ratio	(0028, 0034)	1C	Indicated even if the pixel aspect ratio of the generated image is: 1\1.

Rows	(0028,0010)	1	<u>Screen Save image</u> If original image rows < 512, then 512 If 512<= original image rows <= 2560, then original image rows If 2560 < original image rows, then 2560 <u>Filmer</u> If original image rows < 256, then 256 If 256 <= original image rows <= 2560, then original image rows If 2560 < original image rows, then 2560
Columns	(0028,0011)	1	<u>Screen Save image</u> If original image columns < 512, then 512 If 512<= original image columns <= 2560, then original image columns If 2560 < original image columns, then 2560 <u>Filmer</u> If original image columns < 256, then 256 If 256 <= original image columns <= 2560, then original image columns If 2560 < original image columns, then 2560
Bits Allocated	(0028,0100)	1	Copy of original image <i>Bits Allocated</i> value or 8 if the element (0028, 0002) has value 3.
Bits Stored	(0028,0101)	1	Copy of original image <i>Bits Stored</i> value or 8 if the element (0028, 0002) has value 3
High Bit	(0028,0102)	1	Bits Stored - 1
Pixel Representation	(0028,0103)	1	Copy of original image <i>Pixel Representation</i> value or 0000h if the element (0028, 0002) has value 3
Pixel Data	(7FE0,0010)	1	Derived from original pixel data

6.4.5.2.1 Image Pixel Module Augmentation

This section specified the DICOM tags added for the Secondary Captures in the Image Pixel Module.

Pixel Spacing	(0028,0030)	3	Copy of the original image <i>Pixel Spacing</i> if present in original image Not Present if field is not present in original image
---------------	-------------	---	---

6.4.6 Overlay Plan Modules

This module is not implemented for this IOD.

6.4.7 Lookup Table Modules

6.4.7.1 VOI LUT module

This section specifies the Attributes that describe the VOI LUT.

TABLE 6.4-8
VOI LUT MODULE ATTRIBUTES

Attribute Name	Tag	Type	Attribute Description
VOI LUT Sequence	(0028, 3010)	3	Present when the image displayed uses a private VOI LUT or when present in the original image.
> LUT Descriptor	(0028, 3002)	1C	Refer to § 6.4.7.1.1
> LUT Data	(0028, 3006)	1C	The VOI LUT Data in the item. If the number of data is $< 2^{16}-1$, then the Value Representation is set to US. If the number of data is $> 2^{16}-1$, then the Value Representation is set to OW.
Window Center	(0028,1050)	3	Current <i>Window Center (WL)</i> + value of element (0x0028,0x1052) of original image if found in the original image header. This element is applicable only with <i>Photometric Interpretation</i> (0x0028,0x0004) value of MONOCHROME1 and MONOCHROME2 otherwise this element is <i>Not Present</i>
Window Width	(0028,1051)	1C	If <i>Window Width</i> (0x0028,0x1050) value is stored a window width value is stored in this element. This element is written only with <i>Photometric Interpretation</i> (0x0028,0x0004) value of MONOCHROME1 and MONOCHROME2 otherwise this element is <i>Not Present</i>

Note: When the VOI LUT Sequence is present in the image, there is always only one item present in this sequence.

6.4.7.1.1 Description of the LUT descriptor

The first value is set to the number of entries in the look up table. It is set to 0 if the number of entries is equal to 2^{16} .

The second value is set to the first input value mapped.

The third value is always 16.

If the possible range after application of rescale slope/rescale intercept is signed, the Value Representation is set to SS. Otherwise, the Value Representation is set to US.

6.4.7.2 Modality LUT module

This section specifies the Attributes that describe the Modality LUT.

TABLE 6.4-9
MODALITY LUT MODULE ATTRIBUTES

Attribute Name	Tag	Type	Attribute Description
Rescale Intercept	(0028,1052)	1C	If original image header contains <i>Rescale intercept</i> value then the SC image contains its copy or the element is <i>Not applicable</i> if the element (0028, 0002) has value 3 or, if neither condition can be satisfied this element is <i>Not Present</i> .
Rescale Slope	(0028,1053)	1C	If original image header contains <i>Rescale slope</i> value then the SC image contains its copy or the element is <i>Not applicable</i> if the element (0028, 0002) has value 3 or, if neither condition can be satisfied this element is <i>Not Present</i> .
Rescale Type	(0028,1054)	1C	If the element (0028, 0002) has value of 3 or if the image header does not contain <i>Rescale intercept</i> , this element is not present, otherwise it is set to US.

6.4.8 General Modules

The SOP Common Module is mandatory for all DICOM IODs.

6.4.8.1 SOP Common Module

This section defines the Attributes that are required for proper functioning and identification of the associated SOP Instances. They do not specify any semantics about the Real-World Object represented by the IOD.

**TABLE 6.4-10
SOP COMMON MODULE ATTRIBUTES**

Attribute Name	Tag	Type	Attribute Description
SOP Class UID	(0008,0016)	1	1.2.840.10008.5.1.4.1.1.7
SOP Instance UID	(0008,0018)	1	Generated from GE Based UID; <station configuration> and timestamp.
Specific Character Set	(0008,0005)	1C	A copy of original image character set or default ISO_IR 100 character set if the character set cannot be found in original image (ISO_IR 100 character set is always used). IMPORTANT: if one of the following notation is encountered in this field of the original image: iso ir 100, iso-ir 100 the creation of secondary capture cannot be refused and correct character set must be used for this field instead. NOTE: The process of generation of the secondary capture image does not support escape sequences like following: ISO 2022 IR 100\ISO 2022 IR 109. If an escape sequence is used in the original image the creation of the secondary capture can be refused.

6.4.9 SC Modules

This Section describes SC Equipment, and Image Modules. These Modules contain Attributes that are specific to SC Image IOD.

6.4.9.1 SC Equipment Module

This Module describes equipment used to convert images into a DICOM format.

**TABLE 6.4-11
SC IMAGE EQUIPMENT MODULE ATTRIBUTES**

Attribute Name	Tag	Type	Attribute Description
Conversion Type	(0008,0064)	1	WSD
Modality	(0008,0060)	3	Original if Screen Save Image OT if Filmer Image
Secondary Capture Device ID	(0018,1010)	3	Real UNIX station host name
Secondary Capture Device Manufacturer	(0018,1016)	3	GE MEDICAL SYSTEMS
Secondary Capture Device Manufacturer's Model Name	(0018,1018)	3	AW4.2
Secondary Capture Device Software Version	(0018,1019)	3	Build: <software version build identifier>

6.4.9.2 SC Image Module

The table in this Section contains IOD Attributes that describe SC images.

**TABLE 6.4-12
SC IMAGE MODULE ATTRIBUTES**

Attribute Name	Tag	Type	Attribute Description
Date of Secondary Capture	(0018,1012)	3	Creation date of the Secondary Capture
Time of Secondary Capture	(0018,1014)	3	Creation time of the Secondary Capture

6.5 SC-PRIVATE DATA DICTIONARY

This section describes the private attributes of this IOD.

**TABLE 6.5-1
PRIVATE CREATOR IDENTIFICATION: GEMS AWSOFT_SB1**

Attribute Name	Tag	Type	VR	VM	Attribute Description
Reference to Study UID	(0039,XX50)	3	UI	1	Reference of the original Study UID if applicable
Reference to Series UID	(0039,XX51)	3	UI	1	Reference of the original Series UID if applicable
Reference to Original Instance Number	(0039,XX52)	3	IS	1	Reference of the original Instance Number if applicable

**TABLE 6.5-2
PRIVATE CREATOR IDENTIFICATION: GEMS IDEN_01**

Attribute Name	Tag	Type	VR	VM	Attribute Description
Full fidelity	(0009,XX01)	3	LO	1	Refer to SM2162114. Appendix B
Suite id	(0009,XX02)	3	SH	1	Refer to SM2162114. Appendix B
Product id	(0009,XX04)	3	SH	1	Refer to SM2162114. Appendix B
Image actual date	(0009,XX27)	3	SL	1	Refer to SM2162114. Appendix B
Service id	(0009,XX30)	3	SH	1	Refer to SM2162114. Appendix B

Mobile location number	(0009,XX31)	3	SH	1	Refer to SM2162114. Appendix B
Equipment UID	(0009,XXE3)	3	UI	1	Refer to SM2162114. Appendix B
Genesis Version - now	(0009,XXE6)	3	SH	1	Refer to SM2162114. Appendix B
Exam Record checksum	(0009,XXE7)	3	UL	1	Refer to SM2162114. Appendix B
Series Suite Id	(0009,XXE8)	3	SH	1	Refer to SM2162114. Appendix B
Actual series data time stamp	(0009,XXE9)	3	SL	1	Refer to SM2162114. Appendix B

TABLE 6.5-3
PRIVATE CREATOR IDENTIFICATION: GEMS RELA 01

Attribute Name	Tag	Type	VR	VM	Attribute Description
Series from which Prescribed	(0021,XX03)	3	SS	1	Refer to SM2162114. Appendix B
Genesis Version - now	(0021,XX05)	3	SH	1	Refer to SM2162114. Appendix B
Series Record checksum	(0021,XX07)	3	UL	1	Refer to SM2162114. Appendix B
Screen Format	(0021,XX37)	3	SS	1	Refer to SM2162114. Appendix B

TABLE 6.5-4
PRIVATE CREATOR IDENTIFICATION: GEMS SERS 01

Attribute Name	Tag	Type	VR	VM	Attribute Description
Images in Series	(0025,XX07)	3	SL	1	Refer to SM2162114. Appendix B
Last Instance Number used	(0025,XX19)	3	SL	1	Refer to SM2162114. Appendix B
Primary Receiver Suite and Host	(0025,XX1A)	3	SH	1	Refer to SM2162114. Appendix B

TABLE 6.5-5
PRIVATE CREATOR IDENTIFICATION: GEMS IMPS 01

Attribute Name	Tag	Type	VR	VM	Attribute Description
Version of the hdr struct	(0029,XX26)	3	SS	1	Refer to SM2162114. Appendix B
Advantage comp. Overflow	(0029,XX34)	3	SL	1	Refer to SM2162114. Appendix B
Advantage comp. Underflow	(0029,XX35)	3	SL	1	Refer to SM2162114. Appendix B

TABLE 6.5-6
PRIVATE CREATOR IDENTIFICATION: GEMS PARM 01

Attribute Name	Tag	Type	VR	VM	Attribute Description
Decon kernel parameters	(0043,XX13)	3	SS	5	Refer to SM2162114. Appendix B

Note: These elements are present in the generated Secondary Capture if these elements were present in the original images

7. ENHANCED SR INFORMATION OBJECT IMPLEMENTATION

7.1 INTRODUCTION

This section specifies the use of the DICOM Enhanced SR IOD to represent the information included in Enhanced SR produced by this implementation. Corresponding attributes are conveyed using the module construct. The contents of this section are:

7.2- ENHANCED SR Entity-Relationship Model

7.3- ENHANCED SR-IOD MODULE TABLE

7.4- ENHANCED SR -INFORMATION MODULE DEFINITIONS

7.5- ENHANCE SR – PRIVATE DATA DICTIONARY

7.6- ENHANCE SR – TEMPLATE IDENTIFICATION

7.7- ENHANCE SR - Private Coded Entries

Note: The Enhanced DICOM SR produced by this implementation is also named: “Electronic Film”

7.2 ENHANCED SR ENTITY-RELATIONSHIP MODEL

The Entity-Relationship diagram for the ENHANCED SR interoperability schema is shown in **Illustration 7.2.1**. In this figure, the following diagrammatic convention is established to represent the information organization:

- Each entity is represented by a rectangular box
- Each relationship is represented by a diamond shaped box.
- The fact that a relationship exists between two entities is depicted by lines connecting the corresponding entity boxes to the relationship boxes.

The relationships are fully defined with the maximum number of possible entities in the relationship shown. In other words, the relationship between Series and Image can have up to n Images per Series, but the Patient to Study relationship has 1 Study for each Patient (a Patient can have more than one Study on the system, however each Study will contain all of the information pertaining to that Patient).

ILLUSTRATION 7.2-1
ENHANCED SR IMAGE ENTITY RELATIONSHIP DIAGRAM

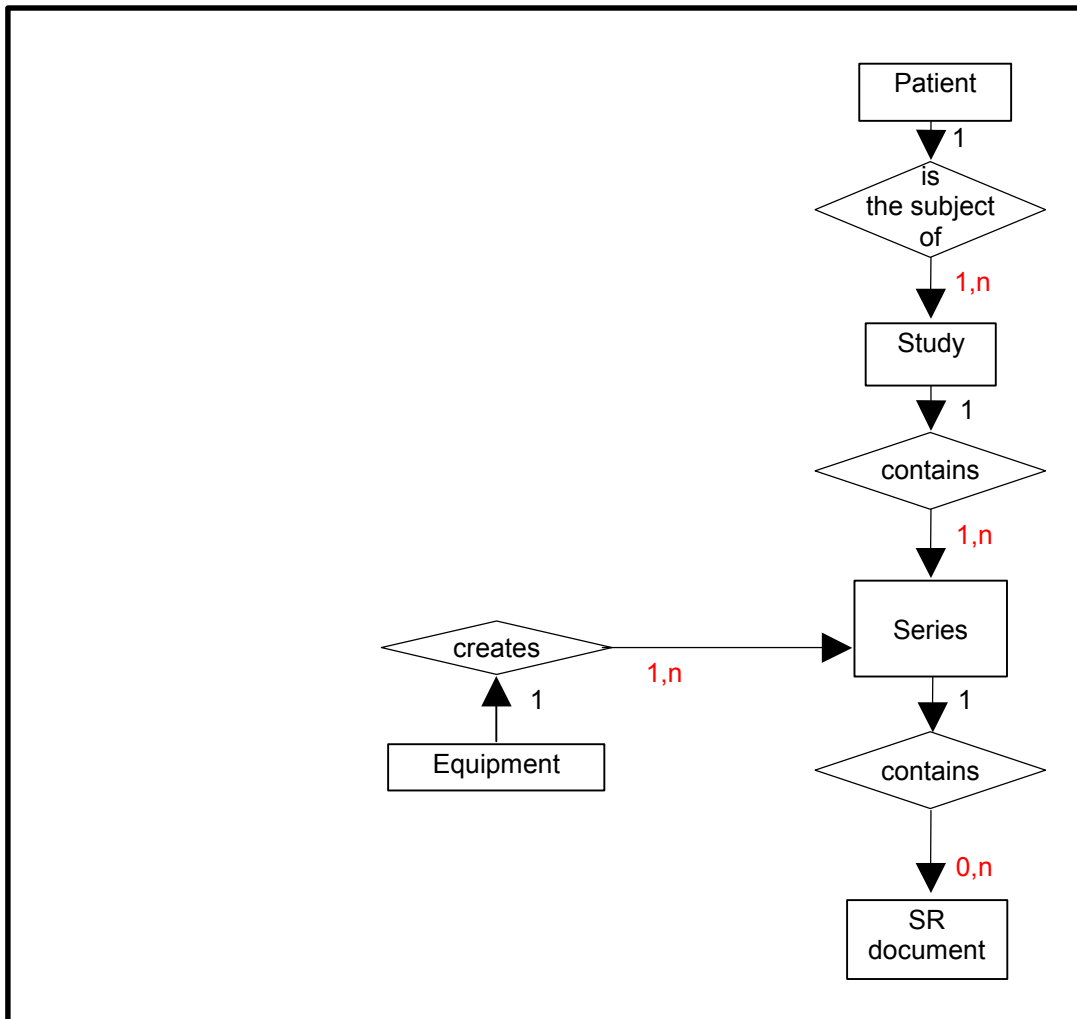

7.2.1 ENTITY DESCRIPTIONS

Please refer to DICOM Standard Part 3 (Information Object Definitions) for a description of each of the entities contained within the ENHANCED SR Information Object.

7.2.2 Advantage Workstation 4.2 Mapping of DICOM entities

**TABLE 7.2-1
 MAPPING OF DICOM ENTITIES TO ADVANTAGE WORKSTATION 4.2 ENTITIES**

DICOM	Advantage Workstation 4.2 Entity
Patient	Patient
Study	Exam
Series	Series
SR document	SR document

7.3 ENHANCED SR-IOD MODULE TABLE

Within an entity of the DICOM ENHANCED SR IOD, attributes are grouped into related set of attributes. A set of related attributes is termed a module. A module facilitates the understanding of the semantics concerning the attributes and how the attributes are related with each other. A module grouping does not infer any encoding of information into datasets.

Table 7.3.1 identifies the defined modules within the entities which comprise the DICOM SC IOD. Modules are identified by Module Name.

See DICOM Part 3 for a complete definition of the entities, modules, and attributes.

**TABLE 7.3-1
 ENHANCED SR DOCUMENT IOD MODULES**

Entity Name	Module Name	Reference
Patient	Patient	7.4.1.1
	Specimen Identification	N/A
Study	General Study	7.4.2.1
	Patient Study	7.4.2.2
Series	SR document Series	7.4.3.1
Equipment	General Equipment	7.4.4.1
Document	SR document General	7.4.5.1
	SR document Content	7.4.5.2
	SOP Common	7.4.6.1

7.4 ENHANCED SR -INFORMATION MODULE DEFINITIONS

Please refer to DICOM Standard Part 3 (Information Object Definitions) for a description of each of the entities and modules contained within the ENHANCED SR Information Object.

The following modules are included to convey Enumerated Values, Defined Terms, and Optional Attributes supported. Type 1 & Type 2 Attributes are also included for completeness and to define what values they may take and where these values are obtained from. It should be noted that they are the same ones as defined in the DICOM Standard Part 3 (Information Object Definitions).

An Electronic Film is a DICOM ENHANCED SR IOP generated by the application ‘Filmer’ of Advantage Workstation 4.2.

7.4.1 Common Patient Entity Modules

7.4.1.1 Patient Module

This section specifies the attributes of the Patient that describe and identify the Patient who is the subject of a diagnostic Study. This Module contains attributes of the patient that are needed for diagnostic interpretation of the Image and are common for all studies performed on the patient.

**TABLE 7.4-1
PATIENT MODULE ATTRIBUTES**

Attribute Name	Tag	Type	Attribute Description
Patient's Name	(0010,0010)	2	Original if No Mix Mode or Mix Mode = Study User defined if Mix Mode = Patient
Patient ID	(0010,0020)	2	Original if No Mix Mode or Mix Mode = Study Function of pid and time if Mix Mode = Patient
Patient's Birth Date	(0010,0030)	2	Original if No Mix Mode or Mix Mode = Study Empty if Mix Mode = Patient
Patient's Sex	(0010,0040)	2	Original if No Mix Mode or Mix Mode = Study Empty if Mix Mode = Patient

7.4.2 Common Study Entity Modules

The following Study IE Modules are common to all Composite Image IODs that reference the Study IE. These Modules contain Attributes of the patient and study that are needed for diagnostic interpretation of the image.

7.4.2.1 General Study Module

This section specifies the Attributes, which describe and identify the Study performed upon the Patient.

TABLE 7.4-2
GENERAL STUDY MODULE ATTRIBUTES

Attribute Name	Tag	Type	Notes
Study Instance UID	(0020,000D)	1	Original if No Mix Mode Generated if Mix Mode = Patient or Mix Mode = Study
Study Date	(0008,0020)	2	Original (Empty if does not exist) if No Mix Mode Empty if Mix Mode = Patient or Mix Mode = Study
Study Time	(0008,0030)	2	Original (Empty if does not exist) if No Mix Mode Empty if Mix Mode = Patient or Mix Mode = Study
Accession Number	(0008,0050)	2	Original (Empty if does not exist) if No Mix Mode Empty if Mix Mode = Patient or Mix Mode = Study
Referring Physician's Name	(0008,0090)	2	Original (Empty if does not exist) if No Mix Mode Empty if Mix Mode = Patient or Mix Mode = Study
Study Description	(0008,1030)	3	Original (Empty if does not exist) if No Mix Mode User defined if Mix Mode = Patient or Mix Mode = Study
Study ID	(0020,0010)	2	Original (Empty if does not exist) if No Mix Mode Empty if Mix Mode = Patient or Mix Mode = Study

7.4.2.2 Patient Study Module

This section defines Attributes that provide information about the Patient at the time the Study was performed.

**TABLE 7.4-3
PATIENT STUDY MODULE ATTRIBUTES**

Attribute Name	Tag	Type	Attribute Description
Patient's Age	(0010,1010)	3	Original if No Mix Mode Not present if Mix Mode = Patient or Mix Mode = Study
Patient's Size	(0010,1020)	3	Original if No Mix Mode Not present if Mix Mode = Patient or Mix Mode = Study
Patient's Weight	(0010,1030)	3	Original if No Mix Mode Not present if Mix Mode = Patient or Mix Mode = Study

7.4.3 SR Document Series Entity Modules

The following SR Document Series IE Modules are common to all Composite Image IODs that reference the SR Document Series IE.

7.4.3.1 SR Document Series Module

This section specifies the attributes that identify and describe general information about the SR Document Series within a Study.

**TABLE 7.4-4
SR DOCUMENT SERIES MODULE ATTRIBUTES**

Attribute Name	Tag	Type	Attribute Description
Modality	(0008,0060)	1	SR
Series Instance UID	(0020,000E)	1	Generated
Series Number	(0020,0011)	2	Generated
Referenced Performed Procedure Step Sequence	(0008,1111)	2	Empty

7.4.3.1.1 SR Document Series Module Augmentation

This section specified the DICOM tags added for the Electronic Film in the SR Document Series Module.

Attribute Name	Tag	Type	Attribute Description
Series Description	(0008,103E)	3	AW Electronic Film

7.4.4 Common Equipment Entity Modules

The following Equipment IE Module is common to all Composite Image IODs that reference the Equipment IE.

7.4.4.1 General Equipment Module

This section specifies the attributes that identify and describe the piece of equipment that produced a Series of Images.

**TABLE 7.4-5
GENERAL EQUIPMENT MODULE ATTRIBUTES**

Attribute Name	Tag	Type	Attribute Description
Manufacturer	(0008,0070)	2	GE MEDICAL SYSTEMS
Institution Name	(0008,0080)	3	Not Present
Institution Address	(0008,0081)	3	Not Present
Station Name	(0008,1010)	3	Not Present
Manufacturer's Model Name	(0008,1090)	3	Not Present
Software Versions	(0018,1020)	3	Not Present

7.4.5 SR document Entity Modules

The following SR document Modules are common to all Composite Image IODs that reference the Image IE.

7.4.5.1 SR document General

This section specifies the attributes that identify and describe the SR document.

**TABLE 7.4-6
SR DOCUMENT GENERAL MODULE ATTRIBUTES**

Attribute Name	Tag	Type	Attribute Description
Instance Number	(0020, 0013)	1	Generated
Completion flag	(0040, A491)	1	COMPLETE
Verification flag	(0040, A493)	1	VERIFIED
Content Date	(0008, 0023)	1	Generated at the date when the Electronic film is created
Content Time	(0008, 0033)	1	Generated at the time when the Electronic film is created
Verifying Observer Sequence	(0040,A073)	1C	
> Verifying Observer Name	(0040,A075)	1	Name of the user that currently is logged on the station
> Verifying Observer Code Sequence	(0040,A088)	2	Empty
> Verifying Organization	(0040,A027)	1	Institution Name (0008,0080) of General Equipment Module
> Verifying Date Time	(0040,A030)	1	Generated at the time when the Electronic film is created
Performed Procedure Code Sequence	(0040, A372)	2	Empty
Current Requested Procedure Evidence Sequence	(0040,A375)	1C	List of images from all studies considered as input of the Electronic Film
> Study Instance UID	(0020,000D)	1	Refer to (0040,A375)
> Referenced Series Sequence	(0008,1115)	1	Refer to (0040,A375)

>> Series Instance UID	(0020,000E)	1	Refer to (0040,A375)
>> Referenced SOP Sequence	(0008,1199)	1	Refer to (0040,A375)
>>> Referenced SOP Class UID	(0008,1150)	1	Refer to (0040,A375)
>>> Referenced SOP Instance UID	(0008,1155)	1	Refer to (0040,A375)

7.4.5.2 SR Document Content Module

This section specifies the attributes that identify and describe the SR content

TABLE 7.4-7
SR DOCUMENT CONTENT MODULE ATTRIBUTES

Attribute Name	Tag	Type	Attribute Description
Content Template Sequence	(0040, A504)	1C	Template that describes the content of the content item
> Mapping Resource	(0008, 0105)	1	PRIVATE
> Template Identifier	(0040, DB00)	1	AW41 EF TID
Content Sequence	(0040, A730)	1C	Content of the DICOM SR
Value Type	(0040, A040)	1	CONTAINER
Concept Name code Sequence	(0040, A043)	1C	
> Code Value	(0008, 0100)	1C	AWVF-0001
> Coding Scheme Designator	(0008, 0102)	1C	99GEMS
> Code Meaning	(0008, 0104)	1C	Electronic Film Presentation
Continuity Of Content	(0040, A050)	1C	SEPARATE

7.4.6 General Modules

The SOP Common Module is mandatory for all DICOM IODs.

7.4.6.1 SOP Common Module

This section defines the Attributes that are required for proper functioning and identification of the associated SOP Instances. They do not specify any semantics about the Real-World Object represented by the IOD.

TABLE 7.4-4
SOP COMMON MODULE ATTRIBUTES

Attribute Name	Tag	Type	Attribute Description
SOP Class UID	(0008,0016)	1	1.2.840.10008.5.1.4.1.1.88.22
SOP Instance UID	(0008,0018)	1	Generated from GE Based UID, <station configuration> and timestamp.
Specific Character Set	(0008,0005)	1C	Not used

7.5 ENHANCE SR – PRIVATE DATA DICTIONARY

This section describes the private attributes of this IOD.

TABLE 7.5-1
PRIVATE CREATOR IDENTIFICATION: GEMS AWSOFT SB1

Attribute Name	Tag	Type	VR	VM	Attribute Description
Private Entity Launch Command	(0039,XX95)	3	LO	1	Name of application to launch

7.6 ENHANCE SR – TEMPLATE IDENTIFICATION

This section describes the Electronic Film Presentation Template

This template describes how the SR Document Content Module of the Enhanced SR Information Object Definition is constrained for the purpose of implementing the Electronic Film.

7.6.1 TID Electronic Film Presentation

	NL	Rel with Parent	VT	Concept Name	VM	Req Type	Condition	Value Set Constraint
1			CONTAINER	EV(AWVF-0001,99GEMS, "Electronic Film Presentation")	1	M		Root Node
2	>	HAS OBS CONTEXT	INCLUDE	DTID (1003) "Person observer identifying attributes"	1	M		
3	>	CONTAINS	INCLUDE	ETID Page Presentation	1-n	U		

7.6.2 TID Page Presentation

	NL	Rel with Parent	VT	Concept Name	VM	Req Type	Condition	Value Set Constraint
1		-	CONTAINER	EV(AWVF-0002, 99GEMS, Page Presentation)	1	M		
2	>	CONTAINS	INCLUDE	ETID Slot Group Presentation	1-n	U		

7.6.3 TID Slot Group Presentation

	NL	Rel with Parent	VT	Concept Name	VM	Req Type	Condition	Value Set Constraint
1		-	CONTAINER	EV(AWVF-0003, 99GEMS, "Slot Group Presentation")	1	M		
2	>	CONTAINS	INCLUDE	ETID Geometry	1	M		
3	>	CONTAINS	INCLUDE	ETID Slot Presentation	1-n	U		

7.6.4 TID Slot Presentation

	NL	Rel with Parent	VT	Concept Name	VM	Req Type	Condition	Value Set Constraint
1		-	CONTAINER	EV(AWVF-0004, 99GEMS, "Slot Presentation")	1	M		
2	>	CONTAINS	INCLUDE	ETID Geometry	1	M		
3	>	CONTAINS	TEXT	EV(AWVF-0009, 99GEMS, "Notepad")	1	UC	if row 4 and 5 absents	
4	>	CONTAINS	IMAGE		1	UC	if row 3 and 5 absents	
5	>	-	INCLUDE	ETID Cine Sequence	1	UC	if row 3 and 4 absents	

7.6.5 TID Cine Sequence

	NL	Rel with Parent	VT	Concept Name	VM	Req Type	Condition	Value Set Constraint
1		CONTAINS	NUM	EV(AWVF-0010, 99GEMS, "Time between cine frames")	1	M		UNITS=EV(UCUM,s,"second")
2		CONTAINS	IMAGE		1-n	M		

7.6.6 TID Geometry

	NL	Rel with Parent	VT	Concept Name	VM	Req Type	Condition	Value Set Constraint
1		-	NUM	EV(AWVF-0005, 99GEMS, "Relative horizontal position of top left corner")	1	M		Value shall be in [0, 1] UNITS=EV(UCUM,%, "percent")
2		-	NUM	EV(AWVF-0006, 99GEMS, "Relative vertical position of top left corner ")	1	M		Value shall be in [0, 1] UNITS=EV(UCUM,%, "percent")
3		-	NUM	EV(AWVF-0007, 99GEMS, "Relative horizontal size")	1	M		Value shall be in [0, 1] UNITS=EV(UCUM,%, "percent")
4		-	NUM	EV(AWVF-0008, 99GEMS, "Relative vertical size")	1	M		Value shall be in [0, 1] UNITS=EV(UCUM,%, "percent")

7.7 ENHANCE SR - PRIVATE CODED ENTRIES

The private coded entries that are required for implementing the Electronic Film are listed below (these are referred to in the Electronic Film Presentation Template).

TABLE 7.7-1
PRIVATE CODED ENTRIES: 99GEMS

Coded Entries		
Coding Scheme Designator (0008,0102)	Code Value (0008,0100)	Code Meaning (0008,0104)
99GEMS	AWVF-0001	Electronic Film Presentation
99GEMS	AWVF-0002	Page Presentation
99GEMS	AWVF-0003	Slot Group Presentation
99GEMS	AWVF-0004	Slot Presentation
99GEMS	AWVF-0005	Relative horizontal position of top left corner
99GEMS	AWVF-0006	Relative vertical position of top left corner
99GEMS	AWVF-0007	Relative horizontal size
99GEMS	AWVF-0008	Relative vertical size
99GEMS	AWVF-0009	Notepad
99GEMS	AWVF-0010	Time between cine frames

8. PRIVATE OBJECT INFORMATION OBJECT IMPLEMENTATION

8.1 INTRODUCTION

This section specifies the use of the (DPO) DICOM Private Object IOD to represent the information included in DPOs produced by this implementation. Corresponding attributes are conveyed using the module construct. The DICOM Private Object is for internal use only. It cannot be networked and archived. It can only be stored into Advantage Workstation Database. The contents of this section are:

8.2- DPO Entity-Relationship Model

8.3- DPO-IOD MODULE TABLE

8.4- DPO-INFORMATION MODULE DEFINITIONS

8.5- DPO-PRIVate data dictionary

Note: This private DICOM object does not contain pixels.

8.2 DPO ENTITY-RELATIONSHIP MODEL

The Entity-Relationship diagram for the DPO interoperability schema is shown in **Illustration 8.2.1**. In this figure, the following diagrammatic convention is established to represent the information organization:

- Each entity is represented by a rectangular box
- Each relationship is represented by a diamond shaped box.
- The fact that a relationship exists between two entities is depicted by lines connecting the corresponding entity boxes to the relationship boxes.

The relationships are fully defined with the maximum number of possible entities in the relationship shown. In other words, the relationship between Series and Image can have up to n Images per Series, but the Patient to Study relationship has 1 Study for each Patient (a Patient can have more than one Study on the system, however each Study will contain all of the information pertaining to that Patient).

ILLUSTRATION 8.2-1
DPO ENTITY RELATIONSHIP DIAGRAM

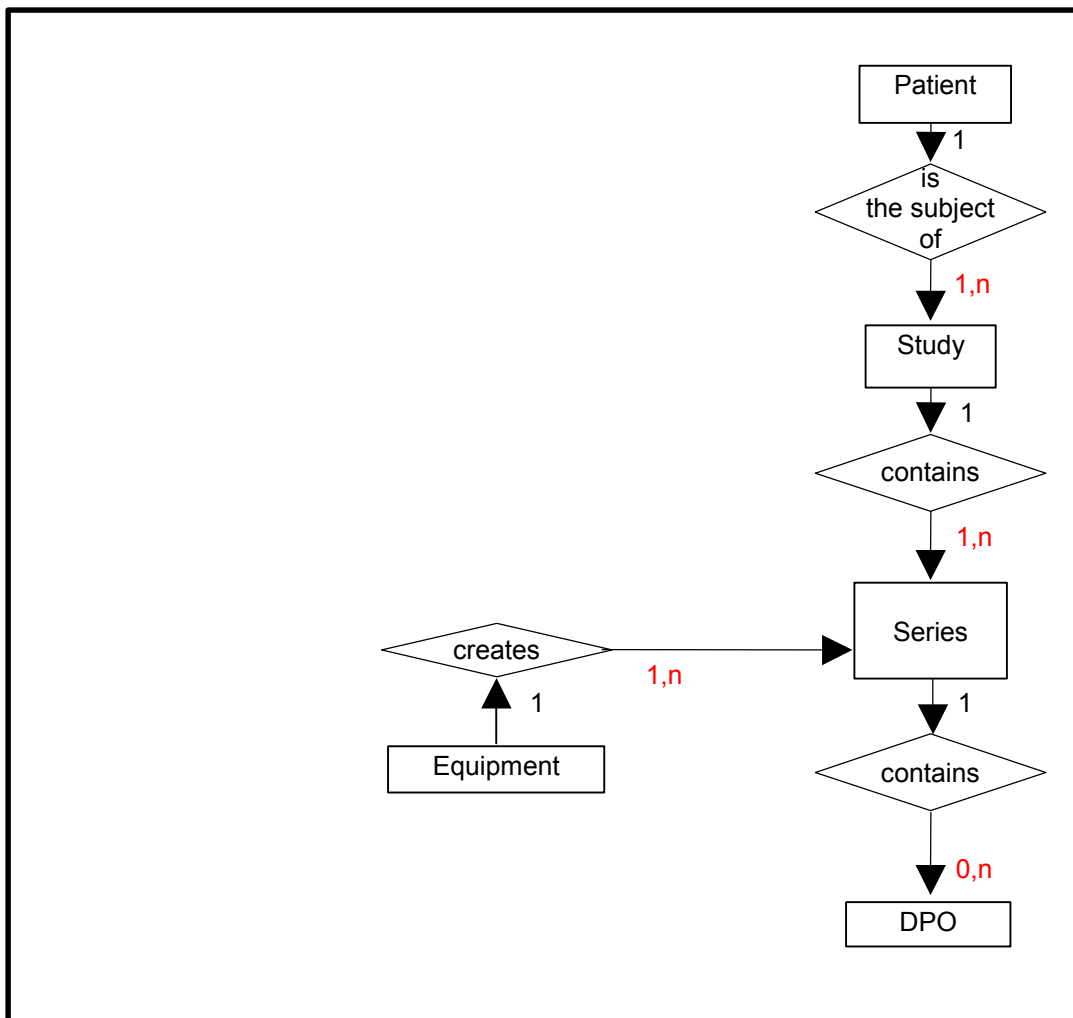

8.2.1 ENTITY DESCRIPTIONS

Please refer to DICOM Standard Part 3 (Information Object Definitions) for a description of each of the entities contained within the DPO Information Object.

8.2.2 Advantage Workstation 4.2 Mapping of DICOM entities

TABLE 8.2-1
MAPPING OF DICOM ENTITIES TO ADVANTAGE WORKSTATION 4.2 ENTITIES

DICOM	Advantage Workstation 4.2 Entity
Patient	Patient
Study	Exam
Series	Series
Image	Image

8.3 DPO-IOD MODULE TABLE

Within an entity of the DICOM SC IOD, attributes are grouped into related set of attributes. A set of related attributes is termed a module. A module facilitates the understanding of the semantics concerning the attributes and how the attributes are related with each other. A module grouping does not infer any encoding of information into datasets.

Table 8.3.1 identifies the defined modules within the entities which comprise the DICOM SC IOD. Modules are identified by Module Name.

See DICOM Part 3 for a complete definition of the entities, modules, and attributes.

TABLE 8.3-1
DPO IOD MODULES

Entity Name	Module Name	Reference
Patient	Patient	8.4.4.1
Study	General Study	8.4.2.1
	Patient Study	8.4.2.2
Series	General Series	8.4.3.1
Equipment	General Equipment	8.4.4.1
DPO	SOP Common	8.4.5.1
	DPO	8.4.5.2

8.4 DPO-INFORMATION MODULE DEFINITIONS

Please refer to DICOM Standard Part 3 (Information Object Definitions) for a description of each of the entities and modules contained within the SC Information Object.

The following modules are included to convey Enumerated Values, Defined Terms, and Optional Attributes supported. Type 1 & Type 2 Attributes are also included for completeness and to define what values they may take and where these values are obtained from. It should be noted that they are the same ones as defined in the DICOM Standard Part 3 (Information Object Definitions).

8.4.1 Common Patient Entity Modules

8.4.1.1 Patient Module

This section specifies the Attributes of the Patient that describe and identify the Patient who is the subject of a diagnostic Study. This Module contains Attributes of the patient that are needed for diagnostic interpretation of the Image and are common for all studies performed on the patient.

TABLE 8.4-1
PATIENT MODULE ATTRIBUTES

Attribute Name	Tag	Type	Attribute Description
Patient's Name	(0010,0010)	2	Same as original image if DPO is declared in same patient Application defined
Patient ID	(0010,0020)	2	Same as original image if DPO is declared in same patient Application defined
Patient's Birth Date	(0010,0030)	2	Same as original image if DPO is declared in same patient Application defined
Patient's Sex	(0010,0040)	2	Same as original image if DPO is declared in same patient Application defined

8.4.2 Common Study Entity Modules

The following Study IE Modules are common to all Composite Image IODs, which reference the Study IE. These Modules contain Attributes of the patient and study that are needed for diagnostic interpretation of the image.

8.4.2.1 General Study Module

This section specifies the Attributes, which describe and identify the Study performed upon the Patient.

TABLE 8.4-2
GENERAL STUDY MODULE ATTRIBUTES

Attribute Name	Tag	Type	Notes
Study Instance UID	(0020,000D)	1	Same as original image if DPO is declared in same study Application defined
Study Date	(0008,0020)	2	Same as original image if DPO is declared in same study Application defined
Study Time	(0008,0030)	2	Empty
Referring Physician's Name	(0008,0090)	2	Empty
Study ID	(0020,0010)	2	Same as original image if DPO is declared in same study Application defined
Accession Number	(0008,0050)	2	Empty
Study Description	(0008,1030)	3	Same as original image if DPO is declared in same study Application defined

8.4.2.2 Patient Study Module

Not used

8.4.3 Common Series Entity Modules

The following Series IE Modules are common to all Composite Image IODs that reference the Series IE.

8.4.3.1 General Series Module

This section specifies the Attributes that identify and describe general information about the Series within a Study.

TABLE 8.4-3
GENERAL SERIES MODULE ATTRIBUTES

Attribute Name	Tag	Type	Attribute Description
Modality	(0008,0060)	1	OT
Series Instance UID	(0020,000E)	1	Generated
Series Number	(0020,0011)	2	Generated
Series Description	(0008,103E)	3	Application defined

8.4.4 Common Equipment Entity Modules

The following Equipment IE Module is common to all Composite Image IODs, which reference the Equipment IE.

8.4.4.1 General Equipment Module

This section specifies the attributes, which identify and describe the piece of equipment, which produced a Series of Images.

TABLE 8.4-4
GENERAL EQUIPMENT MODULE ATTRIBUTES

Attribute Name	Tag	Type	Attribute Description
Manufacturer	(0008,0070)	2	GE MEDICAL SYSTEMS
Station Name	(0008,1010)	3	Name of the station
Manufacturer's Model Name	(0008,1090)	3	Application Name
Software Versions	(0018,1020)	3	Application defined (Application Name + Software Version)

8.4.5 DPO Modules

The SOP Common Module is mandatory for all DICOM IODs.

8.4.5.1 SOP Common Module

This section defines the Attributes, which are required for proper functioning and identification of the associated SOP Instances. They do not specify any semantics about the Real-World Object represented by the IOD.

TABLE 8.4-5
SOP COMMON MODULE ATTRIBUTES

Attribute Name	Tag	Type	Attribute Description
SOP Class UID	(0008,0016)	1	1.2.840.113619.4.25
SOP Instance UID	(0008,0018)	1	Generated from GE Based UID, <station configuration> and timestamp.

Specific Character Set	(0008,0005)	1C	ISO_IR 100
------------------------	-------------	----	------------

8.4.5.2 DPO Module

This section defines the Attributes, which are required for proper functioning and identification of the associated SOP Instances. They do not specify any semantics about the Real-World Object represented by the IOD.

TABLE 8.4-6
DPO MODULE ATTRIBUTES

Attribute Name	Tag	Type	Attribute Description
Instance Number	(0020,5013)	1	Number of the DPO
Reference to Study UID	(0039,5065)	1	Reference of the original Study UID if applicable
Reference to Series UID	(0039,5070)	1	Reference of the original Series UID if applicable
Reference to Original Instance Number	(0039,5075)	1	Reference of the original Instance Number if applicable
DPO Number	(0039,5080)	1	Number of the DPO
DPO Date	(0039,5085)	1	Creation date of the DPO
DPO Time	(0039,5090)	1	Creation time of the DPO
DPO Invocation String	(0039,5095)	1	Invocation String of the DPO
DPO type	(0039,50AA)	2	AWDPO
DPO data	(0039,50FF)	1	Data of the DPO

8.5 DPO-PRIVATE DATA DICTIONARY

This section describes the private attributes of this IOD.

TABLE 8.5-1
PRIVATE CREATOR IDENTIFICATION: GEMS_AWSOFT_CD1

Attribute Name	Tag	Type	VR	VM	Attribute Description
Private Element Creator	(0039,00XX)	1	LO	1	Identification String. Set to GEMS_AWSOFT_CD1
Reference to Study UID	(0039,XX65)	1	UI	1	Reference of the original Study UID if applicable
Reference to Series UID	(0039,XX70)	1	UI	1	Reference of the original Series UID if applicable
Reference to Original Instance Number	(0039,XX75)	1	IS	1	Reference of the original Instance Number if applicable
DPO Number	(0039,XX80)	1	IS	1	Number of the DPO
DPO Number	(0020,XX13)	1	IS	1	Number of the DPO
DPO Date	(0039,XX85)	1	DA	1	Creation date of the DPO
DPO Time	(0039,XX90)	1	TM	1	Creation time of the DPO
DPO Invocation String	(0039,XX95)	2	LO	1	Invocation String of the DPO
DPO type	(0039,XXAA)	1	CS	1	Type of the DPO
DPO data	(0039,XXFF)	1C	OB	1	Data of the DPO