



**GE Healthcare**

*gehealthcare.com*

# **Technical Publication**

**Direction 5643866-1EN  
Revision 1**

**GE Healthcare  
Discovery XR656**

**Optima XR646**

**DICOM Conformance Statement**

Copyright © 2015 by General Electric Company, Inc.  
All rights reserved.



**Published by the GE Company, Inc.**  
*Engineering/Technical:*

---

# **LEGAL NOTES**

---

## **TRADEMARKS**

.All other products and their name brands are the trademarks of their respective holders.

## **COPYRIGHTS**

All Material, Copyright © 2015 by General Electric Company, Inc. All rights reserved. The material presented and contained herein may not be reproduced in any form or manner, without the written permission of General Electric Company, Inc.



# IMPORTANT PRECAUTIONS

## LANGUAGE

- ПРЕДУПРЕЖДЕНИЕ**  
(BG)
- **ТОВА УПЪТВАНЕ ЗА РАБОТА Е НАЛИЧНО САМО НА АНГЛИЙСКИ ЕЗИК.**
  - **АКО ДОСТАВЧИКЪТ НА УСЛУГАТА НА КЛИЕНТА ИЗИСКА ЕЗИК, РАЗЛИЧЕН ОТ АНГЛИЙСКИ, ЗАДЪЛЖЕНИЕ НА КЛИЕНТА Е ДА ОСИГУРИ ПРЕВОД.**
  - **НЕ ИЗПОЛЗВАЙТЕ ОБОРУДВАНЕТО ПРЕДИ ДА СТЕ СЕ КОНСУЛТИРАЛИ И РАЗБРАЛИ УПЪТВАНЕТО ЗА РАБОТА.**
  - **НЕСПАЗВАНЕТО НА ТОВА ПРЕДУПРЕЖДЕНИЕ МОЖЕ ДА ДОВЕДЕ ДО НАРАНЯВАНЕ НА ДОСТАВЧИКА НА УСЛУГАТА, ОПЕРАТОРА ИЛИ ПАЦИЕНТ В РЕЗУЛТАТ НА ТОКОВ УДАР ИЛИ МЕХАНИЧНА ИЛИ ДРУГА ОПАСНОСТ.**

- 警告**  
(ZH-CN)
- 本维修手册仅提供英文版本。
  - 如果维修服务提供商需要非英文版本，客户需自行提供翻译服务。
  - 未详细阅读和完全理解本维修手册之前，不得进行维修。
  - 忽略本警告可能对维修人员，操作员或患者造成触电、机械伤害或其他形式的伤害。

- VÝSTRAHA**  
(CS)
- **TENTO PROVOZNÍ NÁVOD EXISTUJE POUZE V ANGLICKÉM JAZYCE.**
  - **V PŘÍPADĚ, ŽE EXTERNÍ SLUŽBA ZÁKAZNÍKŮM POTŘEBUJE NÁVOD V JINÉM JAZYCE, JE ZAJIŠTĚNÍ PŘEKladU DO ODPOVÍDAJÍCÍHO JAZYKA ÚKOLEM ZÁKAZNÍKA.**
  - **NESNAŽTE SE O ÚDRŽBU TOHOTO ZAŘÍZENÍ, ANIŽ BYSTE SI PŘEČETLI TENTO PROVOZNÍ NÁVOD A POCHOPILI JEHO OBSAH.**
  - **V PŘÍPADĚ NEDODRŽOVÁNÍ TÉTO VÝSTRAHY MŮŽE DOJÍT K PORANĚNÍ PRACOVNÍKA PRODEJNÍHO SERVISU, OBSLUŽNÉHO PERSONÁLU NEBO PACIENTŮ VLIVEM ELEKTRICKÉHO PROUDU, RESPEKTIVE VLIVEM MECHANICKÝCH ČI JINÝCH RIZIK.**

## ADVARSEL

(DA)

- DENNE SERVICEMANUAL FINDES KUN PÅ ENGELSK.
- HVIS EN KUNDES TEKNIKER HAR BRUG FOR ET ANDET SPROG END ENGELSK, ER DET KUNDENS ANSVAR AT SØRGE FOR OVERSÆTTELSE.
- FORSØG IKKE AT SERVICERE UDSTYRET MEDMINDRE DENNE SERVICEMANUAL HAR VÆRET KONSULTERET OG ER FORSTÅET.
- MANGLENDE OVERHOLDELSE AF DENNE ADVARSEL KAN MEDFØRE SKADE PÅ GRUND AF ELEKTRISK, MEKANISK ELLER ANDEN FARE FOR TEKNIKEREN, OPERATØREN ELLER PATIENTEN.

## WAARSCHUWING

(NL)

- DEZE ONDERHOUDSHANDLEIDING IS ENKEL IN HET ENGELS VERKRIJGBAAR.
- ALS HET ONDERHOUDSPERSONEEL EEN ANDERE TAAL VEREIST, DAN IS DE KLANT VERANTWOORDELIJK VOOR DE VERTALING ERVAN.
- PROBEER DE APPARATUUR NIET TE ONDERHOUDEN VOORDAT DEZE ONDERHOUDSHANDLEIDING WERD GERAADPLEEGD EN BEGREPEN IS.
- INDIEN DEZE WAARSCHUWING NIET WORDT OPGEVOLGD, ZOU HET ONDERHOUDSPERSONEEL, DE OPERATOR OF EEN PATIËNT GEWOND KUNNEN RAKEN ALS GEVOLG VAN EEN ELEKTRISCHE SCHOK, MECHANISCHE OF ANDERE GEVAREN.

## WARNING

(EN)

- THIS SERVICE MANUAL IS AVAILABLE IN ENGLISH ONLY.
- IF A CUSTOMER'S SERVICE PROVIDER REQUIRES A LANGUAGE OTHER THAN ENGLISH, IT IS THE CUSTOMER'S RESPONSIBILITY TO PROVIDE TRANSLATION SERVICES.
- DO NOT ATTEMPT TO SERVICE THE EQUIPMENT UNLESS THIS SERVICE MANUAL HAS BEEN CONSULTED AND IS UNDERSTOOD.
- FAILURE TO HEED THIS WARNING MAY RESULT IN INJURY TO THE SERVICE PROVIDER, OPERATOR OR PATIENT FROM ELECTRIC SHOCK, MECHANICAL OR OTHER HAZARDS.

## HOIATUS

(ET)

- KÄESOLEV TEENINDUSJUHEND ON SAADAVAL AINULT INGLISE KEELES.
- KUI KLIENDITEENINDUSE OSUTAJA NÕUAB JUHENDIT INGLISE KEELEST ERINEVAS KEELES, VASTUTAB KLIENT TÖLKETEENUSE OSUTAMISE EEST.
- ÄRGE ÜRITAGE SEADMEID TEENINDADA ENNE EELNEVALT KÄESOLEVA TEENINDUSJUHENDIGA TUTVUMIST JA SELLEST ARU SAAMIST.
- KÄESOLEVA HOIATUSE EIRAMINE VÕIB PÕHJUSTADA TEENUSEOSUTAJA, OPERAATORI VÕI PATSIENDI VIGASTAMIST ELEKTRILÖÖGI, MEHAANILISE VÕI MUU OHU TAGAJÄRJEL.

## **VAROITUS**

(FI)

- TÄMÄ HUOLTO-OHJE ON SAATAVILLA VAIN ENGLANNIKSI.
- JOS ASIAKKAAN HUOLTOHENKILÖSTÖ VAATII MUUTA KUIN ENGLANNINKIELISTÄ MATERIAALIA, TARVITTAVAN KÄÄNNÖKSEN HANKKIMINEN ON ASIAKKAAN VASTUULLA.
- ÄLÄ YRITÄ KORJATA LAITTEISTOA ENNEN KUIN OLET VARMASTI LUKENUT JA YMMÄRTÄNYT TÄMÄN HUOLTO-OHJEEN.
- MIKÄLI TÄTÄ VAROITUSTA EI NOUDATETA, SEURAUKSENA VOI OLLA HUOLTOHENKILÖSTÖN, LAITTEISTON KÄYTTÄJÄN TAI POTILAAN VAHINGOITTUMINEN SÄHKÖISKUN, MEKAANISEN VIAN TAI MUUN VAARATILANTEEN VUOKSI.

## **ATTENTION**

(FR)

- CE MANUEL DE MAINTENANCE N'EST DISPONIBLE QU'EN ANGLAIS.
- SI LE TECHNICIEN DU CLIENT A BESOIN DE CE MANUEL DANS UNE AUTRE LANGUE QUE L'ANGLAIS, C'EST AU CLIENT QU'IL INCOMBE DE LE FAIRE DETECTORUIRE.
- NE PAS TENTER D'INTERVENTION SUR LES ÉQUIPEMENTS TANT QUE LE MANUEL SERVICE N'A PAS ÉTÉ CONSULTÉ ET COMPRIS.
- LE NON-RESPECT DE CET AVERTISSEMENT PEUT ENTRAÎNER CHEZ LE TECHNICIEN, L'OPÉRATEUR OU LE PATIENT DES BLESSURES DUES À DES DANGERS ÉLECTRIQUES, MÉCANIQUES OU AUTRES.

## **WARNUNG**

(DE)

- DIESE SERVICEANLEITUNG EXISTIERT NUR IN ENGLISCHER SPRACHE.
- FALLS EIN FREMDER KUNDENDIENST EINE ANDERE SPRACHE BENÖTIGT, IST ES AUFGABE DES KUNDEN FÜR EINE ENTSPRECHENDE ÜBERSETZUNG ZU SORGEN.
- VERSUCHEN SIE NICHT DIESE ANLAGE ZU WARTEN, OHNE DIESE SERVICEANLEITUNG GELESEN UND VERSTANDEN ZU HABEN.
- WIRD DIESE WARNUNG NICHT BEACHTET, SO KANN ES ZU VERLETZUNGEN DES KUNDENDIENSTTECHNIKERS, DES BEDIENERS ODER DES PATIENTEN DURCH STROMSCHLÄGE, MECHANISCHE ODER SONSTIGE GEFAHREN KOMMEN.

## **ΠΡΟΕΙΔΟΠΟΙΗΣΗ**

(EL)

- ΤΟ ΠΑΡΟΝ ΕΓΧΕΙΡΙΔΙΟ ΣΕΡΒΙΣ ΔΙΑΤΙΘΕΤΑΙ ΣΤΑ ΑΓΓΛΙΚΑ ΜΟΝΟ.
- ΕΑΝ ΤΟ ΑΤΟΜΟ ΠΑΡΟΧΗΣ ΣΕΡΒΙΣ ΕΝΟΣ ΠΕΛΑΤΗ ΑΠΑΙΤΕΙ ΤΟ ΠΑΡΟΝ ΕΓΧΕΙΡΙΔΙΟ ΣΕ ΓΛΩΣΣΑ ΕΚΤΟΣ ΤΩΝ ΑΓΓΛΙΚΩΝ, ΑΠΟΤΕΛΕΙ ΕΥΘΥΝΗ ΤΟΥ ΠΕΛΑΤΗ ΝΑ ΠΑΡΕΧΕΙ ΥΠΗΡΕΣΙΕΣ ΜΕΤΑΦΡΑΣΗΣ.
- ΜΗΝ ΕΠΙΧΕΙΡΗΣΕΤΕ ΤΗΝ ΕΚΤΕΛΕΣΗ ΕΡΓΑΣΙΩΝ ΣΕΡΒΙΣ ΣΤΟΝ ΕΞΟΠΛΙΣΜΟ ΕΚΤΟΣ ΕΑΝ ΕΧΕΤΕ ΣΥΜΒΟΥΛΕΥΤΕΙ ΚΑΙ ΕΧΕΤΕ ΚΑΤΑΝΟΗΣΕΙ ΤΟ ΠΑΡΟΝ ΕΓΧΕΙΡΙΔΙΟ ΣΕΡΒΙΣ.
- ΕΑΝ ΔΕ ΛΑΒΕΤΕ ΥΠΟΨΗ ΤΗΝ ΠΡΟΕΙΔΟΠΟΙΗΣΗ ΑΥΤΗ, ΕΝΔΕΧΕΤΑΙ ΝΑ ΠΡΟΚΛΗΘΕΙ ΤΡΑΥΜΑΤΙΣΜΟΣ ΣΤΟ ΑΤΟΜΟ ΠΑΡΟΧΗΣ ΣΕΡΒΙΣ, ΣΤΟ ΧΕΙΡΙΣΤΗ Ή ΣΤΟΝ ΑΣΘΕΝΗ ΑΠΟ ΗΛΕΚΤΡΟΠΛΗΞΙΑ, ΜΗΧΑΝΙΚΟΥΣ Ή ΑΛΛΟΥΣ ΚΙΝΔΥΝΟΥΣ.

- FIGYELMEZTETÉS**  
(HU)
- EZEN KARBANTARTÁSI KÉZIKÖNYV KIZÁRÓLAG ANGOL NYELVEN ÉRHETŐ EL.
  - HA A VEVŐ SZOLGÁLTATÓJA ANGOLTÓL ELTÉRŐ NYELVRE TART IGÉNYT, AKKOR A VEVŐ FELELŐSSÉGE A FORDÍTÁS ELKÉSZÍTTETÉSE.
  - NE PRÓBÁLJA ELKEZDENI HASZNÁLNI A BERENDEZÉST, AMÍG A KARBANTARTÁSI KÉZIKÖNYVBEN LEÍRTAKAT NEM ÉRTELMEZTÉK.
  - EZEN FIGYELMEZTETÉS FIGYELMEN KÍVÜL HAGYÁSA A SZOLGÁLTATÓ, MŰKÖDTETŐ VAGY A BETEG ÁRAMÜTÉS, MECHANIKAI VAGY EGYÉB VESZÉLYHELYZET MIATTI SÉRÜLÉSÉT EREDMÉNYEZHETI.
- ADVÖRUN**  
(IS)
- ÞESSI ÞJÓNUSTUHANDBÓK ER EINGÖNGU FÁANLEG Á ENSKU.
  - EF AÐ ÞJÓNUSTUVEITANDI VIÐSKIPTAMANNS ÞARFNAST ANNAS TUNGUMÁLS EN ENSKU, ER ÞAÐ SKYLDA VIÐSKIPTAMANNS AÐ SKAFFA TUNGUMÁLAPJÓNUSTU.
  - REYNIÐ EKKI AÐ AFGREIÐA TÆKIÐ NEMA AÐ ÞESSI ÞJÓNUSTUHANDBÓK HEFUR VERIÐ SKOÐUÐ OG SKILIN.
  - BROT Á SINNA ÞESSARI ADVÖRUN GETUR LEITT TIL MEIÐSLA Á ÞJÓNUSTUVEITANDA, STJÓRNANDA EÐA SJÚKLINGS FRÁ RAFLOSTI, VÉLRÆNU EÐA ÖÐRUM ÁHÆTTUM.
- AVVERTENZA**  
(IT)
- IL PRESENTE MANUALE DI MANUTENZIONE È DISPONIBILE SOLTANTO IN INGLESE.
  - SE UN ADDETTO ALLA MANUTENZIONE ESTERNO ALLA GEMS RICHIEDE IL MANUALE IN UNA LINGUA DIVERSA, IL CLIENTE È TENUTO A PROVVEDERE DIRETTAMENTE ALLA DETECTORUZIONE.
  - SI PROCEDA ALLA MANUTENZIONE DELL'APPARECCHIATURA SOLO DOPO AVER CONSULTATO IL PRESENTE MANUALE ED AVERNE COMPRESO IL CONTENUTO.
  - IL NON RISPETTO DELLA PRESENTE AVVERTENZA POTREBBE FAR COMPIERE OPERAZIONI DA CUI DERIVINO LESIONI ALL'ADDETTO ALLA MANUTENZIONE, ALL'UTILIZZATORE ED AL PAZIENTE PER FOLGORAZIONE ELETTRICA, PER URTI MECCANICI OD ALTRI RISCHI.



## 警告

(JA)

- このサービスマニュアルには英語版しかありません。
- サービスを担当される業者が英語以外の言語を要求される場合、翻訳作業はその業者の責任で行うものとさせていただきます。
- このサービスマニュアルを熟読し理解せずに、装置のサービスを行わないでください。
- この警告に従わない場合、サービスを担当される方、操作員あるいは患者さんが、感電や機械的又はその他の危険により負傷する可能性があります。

## 경고

(KO)

- 본 서비스 지침서는 영어로만 이용하실 수 있습니다.
- 고객의 서비스 제공자가 영어 이외의 언어를 요구할 경우, 번역 서비스를 제공하는 것은 고객의 책임입니다.
- 본 서비스 지침서를 참고했고 이해하지 않는 한은 해당 장비를 수리하려고 시도하지 마십시오.
- 이 경고에 유의하지 않으면 전기 쇼크, 기계상의 혹은 다른 위험으로부터 서비스 제공자, 운영자 혹은 환자에게 위해를 가할 수 있습니다.

## BRĪDINĀJUMS

(LV)

- ŠĪ APKALPES ROKASGRĀMATA IR PIEEJAMA TIKAI ANĢĻU VALODĀ.
- JA KLIENTA APKALPES SNIEDZĒJAM NEPIECIEŠAMA INFORMĀCIJA CITĀ VALODĀ, NEVIS ANĢĻU, KLIENTA PIENĀKUMS IR NODROŠINĀT TULKOŠANU.
- NEVEICIET APRĪKOJUMA APKALPI BEZ APKALPES ROKASGRĀMATAS IZLASĪŠANAS UN SAPRAŠANAS.
- ŠĪ BRĪDINĀJUMA NEIEVĒROŠANA VAR RADĪT ELEKTRISKĀS STRĀVAS TRIECIENA, MEHĀNISKU VAI CITU RISKU IZRAISĪTU TRAUMU APKALPES SNIEDZĒJAM, OPERATORAM VAI PACIENTAM.

## ĮSPĖJIMAS

(LT)

- ŠIS EKSPLOATAVIMO VADOVAS YRA PRIEINAMAS TIK ANGLŲ KALBA.
- JEI KLIENTO PASLAUGŲ TIEKĖJAS REIKALAUJA VADOVO KITA KALBA – NE ANGLŲ, NUMATYTI VERTIMO PASLAUGAS YRA KLIENTO ATSAKOMYBĖ.
- NEMĖGINKITE ATLIKTI ĮRANGOS TECHNINĖS PRIEŽIŪROS, NEBENT ATSIŽVELGĖTE Į ŠĮ EKSPLOATAVIMO VADOVĄ IR JĮ SUPRATOTE.
- JEI NEATKREIPSITE DĖMESIO Į ŠĮ PERSPĖJIMĄ, GALIMI SUŽALOJIMAI DĖL ELEKTROS ŠOKO.
- MECHANINIŲ AR KITŲ PAVOJŲ PASLAUGŲ TIEKĖJUI, OPERATORIUI AR PACIENTUI.

## **ADVARSEL**

(NO)

- DENNE SERVICEHÅNDBOKEN FINNES BARE PÅ ENGELSK.
- HVIS KUNDENS SERVICELEVERANDØR TRENGER ET ANNET SPRÅK, ER DET KUNDENS ANSVAR Å SØRGE FOR OVERSETTELSE.
- IKKE FORSØK Å REPARERE UTSTYRET UTEN AT DENNE SERVICEHÅNDBOKEN ER LEST OG FORSTÅTT.
- MANGLENDE HENSYN TIL DENNE ADVARSELEN KAN FØRE TIL AT SERVICELEVERANDØREN, OPERATØREN ELLER PASIENTEN SKADES PÅ GRUNN AV ELEKTRISK STØT, MEKANISKE ELLER ANDRE FARER.

## **OSTRZEŻENIE**

(PL)

- NINIEJSZY PODRĘCZNIK SERWISOWY DOSTĘPNY JEST JEDYNIEM W JĘZYKU ANGIELSKIM.
- JEŚLI DOSTAWCA USŁUG KLIENTA WYMAGA JĘZYKA INNEGO NIŻ ANGIELSKI, ZAPEWNIENIE USŁUGI TŁUMACZENIA JEST OBOWIĄZKIEM KLIENTA.
- NIE PRÓBOWAĆ SERWISOWAĆ WYPOSAŻENIA BEZ ZAPOZNANIA SIĘ I ZROZUMIENIA NINIEJSZEGO PODRĘCZNIKA SERWISOWEGO.
- NIEZASTOSOWANIE SIĘ DO TEGO OSTRZEŻENIA MOŻE SPOWODOWAĆ URAZY DOSTAWCY USŁUG, OPERATORA LUB PACJENTA W WYNIKU PORAŻENIA ELEKTRYCZNEGO, ZAGROŻENIA MECHANICZNEGO BĄDŹ INNEGO.

## **ATENÇÃO**

(PT)

- ESTE MANUAL DE ASSISTÊNCIA TÉCNICA SÓ SE ENCONTRA DISPONÍVEL EM INGLÊS.
- SE QUALQUER OUTRO SERVIÇO DE ASSISTÊNCIA TÉCNICA, QUE NÃO A GEMS, SOLICITAR ESTES MANUAIS NOUTRO IDIOMA, É DA RESPONSABILIDADE DO CLIENTE FORNECER OS SERVIÇOS DE TRADUÇÃO.
- NÃO TENHA TENTADO REPARAR O EQUIPAMENTO SEM TER CONSULTADO E COMPREENDIDO ESTE MANUAL DE ASSISTÊNCIA TÉCNICA
- O NÃO CUMPRIMENTO DESTA AVISO PODE POR EM PERIGO A SEGURANÇA DO TÉCNICO, OPERADOR OU PACIENTE DEVIDO A CHOQUES ELÉTRICOS, MECÂNICOS OU OUTROS.

## **ATENȚIE**

(RO)

- ACEST MANUAL DE SERVICE ESTE DISPONIBIL NUMAI ÎN LIMBA ENGLEZĂ.
- DACĂ UN FURNIZOR DE SERVICII PENTRU CLIEȚI NECESITĂ O ALTĂ LIMBĂ DECÂT CEA ENGLEZĂ, ESTE DE DATORIA CLIENTULUI SĂ FURNIZEZE O TRADUCERE.
- NU ÎNCERȚAȚI SĂ REPARAȚI ECHIPAMENTUL DECÂT ULTERIOR CONSULTĂRII ȘI ÎNȚELEGERII ACESTUI MANUAL DE SERVICE.
- IGNORAREA ACESTUI AVERTISMENT AR PUTEA DUCE LA RĂNIREA DEPARATORULUI, OPERATORULUI SAU PACIENTULUI ÎN URMA PERICOLELOR DE ELECTROCUTARE, MECANICE SAU DE ALTĂ NATURĂ.

## **ОСТОРОЖНО!**

(RU)

- ДАННОЕ РУКОВОДСТВО ПО ОБСЛУЖИВАНИЮ ПРЕДЛАГАЕТСЯ ТОЛЬКО НА АНГЛИЙСКОМ ЯЗЫКЕ.
- ЕСЛИ СЕРВИСНОМУ ПЕРСОНАЛУ КЛИЕНТА НЕОБХОДИМО РУКОВОДСТВО НЕ НА АНГЛИЙСКОМ, А НА КАКОМ-ТО ДРУГОМ ЯЗЫКЕ, КЛИЕНТУ СЛЕДУЕТ САМОСТОЯТЕЛЬНО ОБЕСПЕЧИТЬ ПЕРЕВОД.
- ПЕРЕД ОБСЛУЖИВАНИЕМ ОБОРУДОВАНИЯ ОБЯЗАТЕЛЬНО ОБРАТИТЕСЬ К ДАННОМУ РУКОВОДСТВУ И ПОЙМИТЕ ИЗЛОЖЕННЫЕ В НЕМ СВЕДЕНИЯ.
- НЕСОБЛЮДЕНИЕ ТРЕБОВАНИЙ ДАННОГО ПРЕДУПРЕЖДЕНИЯ МОЖЕТ ПРИВЕСТИ К ТОМУ, ЧТО СПЕЦИАЛИСТ ПО ОБСЛУЖИВАНИЮ, ОПЕРАТОР ИЛИ ПАЦИЕНТ ПОЛУЧАТ УДАР ЭЛЕКТРИЧЕСКИМ ТОКОМ, МЕХАНИЧЕСКУЮ ТРАВМУ ИЛИ ДРУГОЕ ПОВРЕЖДЕНИЕ.

## **UPOZORNENIE**

(SK)

- TENTO NÁVOD NA OBSLUHU JE K DISPOZÍCII LEN V ANGLIČTINE.
- AK ZÁKAZNÍKOV POSKYTOVATEĽ SLUŽIEB VYŽADUJE INÝ JAZYK AKO ANGLIČTINU, POSKYTNUTIE PREKLADATEĽSKÝCH SLUŽIEB JE ZODPOVEDNOSŤOU ZÁKAZNÍKA.
- NEPOKÚŠAJTE SA O OBSLUHU ZARIADENIA SKÔR, AKO SI NEPREČÍTATE NÁVOD NA OBLUHU A NEPOROZUMIETE MU.
- ZANEDBANIE TOHTO UPOZORNENIA MÔŽE VYÚSTIŤ DO ZRANENIA POSKYTOVATEĽA SLUŽIEB, OBSLUHUJÚCEJ OSOBY ALEBO PACIENTA ELEKTRICKÝM PRÚDOM, DO MECHANICKÉHO ALEBO INÉHO NEBEZPEČENSTVA.

## **ATENCION**

(ES)

- ESTE MANUAL DE SERVICIO SOLO EXISTE EN INGLES.
- SI ALGUN PROVEEDOR DE SERVICIOS AJENO A GEMS SOLICITA UN IDIOMA QUE NO SEA EL INGLES, ES RESPONSABILIDAD DEL CLIENTE OFRECER UN SERVICIO DE TRADUCCION.
- NO SE DEBERA DAR SERVICIO TECNICO AL EQUIPO, SIN HABER CONSULTADO Y COMPRENDIDO ESTE MANUAL DE SERVICIO.
- LA NO OBSERVANCIA DEL PRESENTE AVISO PUEDE DAR LUGAR A QUE EL PROVEEDOR DE SERVICIOS, EL OPERADOR O EL PACIENTE SUFRAN LESIONES PROVOCADAS POR CAUSAS ELÉCTRICAS, MECÁNICAS O DE OTRA NATURALEZA.

## **VARNING**

(SV)

- DEN HÄR SERVICEHANDBOKEN FINNS BARA TILLGÄNGLIG PÅ ENGELSKA.
- OM EN KUNDS SERVICETEKNIKER HAR BEHOV AV ETT ANNAT SPRÅK ÄN ENGELSKA ANSVARAR KUNDEN FÖR ATT TILLHANDAHÅLLA ÖVERSÄTTNINGSTJÄNSTER.
- FÖRSÖK INTE UTFÖRA SERVICE PÅ UTRUSTNINGEN OM DU INTE HAR LÄST OCH FÖRSTÅR DEN HÄR SERVICEHANDBOKEN.
- OM DU INTE TAR HÄNSYN TILL DEN HÄR VARNINGEN KAN DET RESULTERA I SKADOR PÅ SERVICETEKNIKERN, OPERATÖREN ELLER PATIENTEN TILL FÖLJD AV ELEKTRISKA STÖTAR, MEKANISKA FAROR ELLER ANDRA FAROR.

## **DİKKAT**

(TR)

- BU SERVİS KILAVUZUNUN SADECE İNGİLİZCESİ MEVCUTTUR.
- EĞER MÜŞTERİ TEKNİSYENİ BU KILAVUZU İNGİLİZCE DIŞINDA BİR BAŞKA LİSANDAN TALEP EDERSE, BUNU TERCÜME ETTİRMEK MÜŞTERİYE DÜŞER.
- SERVİS KILAVUZUNU OKUYUP ANLAMADAN EKİPMANLARA MÜDAHALE ETMEYİNİZ.
- BU UYARIYA UYULMAMASI, ELEKTRİK, MEKANİK VEYA DİĞER TEHLİKELERDEN DOLAYI TEKNİSYEN, OPERATÖR VEYA HASTANIN YARALANMASINA YOL AÇABİLİR.

## **DAMAGE IN TRANSPORTATION**

All packages should be closely examined at time of delivery. If damage is apparent write "Damage In Shipment" on ALL copies of the freight or express bill BEFORE delivery is accepted or "signed for" by a GE representative or hospital receiving agent. Whether noted or concealed, damage MUST be reported to the carrier immediately upon discovery, or in any event, within 14 days after receipt, and the contents and containers held for inspection by the carrier. A transportation company will not pay a claim for damage if an inspection is not requested within this 14 day period.

Call GEHC Global Parts 1-800-548-3366 and select option 8, immediately after damage is found. At this time be ready to supply name of carrier, delivery date, consignee name, freight or express bill number, item damaged and extent of damage.

Complete instructions regarding claim procedure are found in Section S of the Policy And Procedures Bulletins.

14 July 1993

## **CERTIFIED ELECTRICAL CONTRACTOR STATEMENT**

All electrical Installations that are preliminary to positioning of the equipment at the site prepared for the equipment shall be performed by licensed electrical contractors. In addition, electrical feeds into the Power Distribution Unit shall be performed by licensed electrical contractors. Other connections between pieces of electrical equipment, calibrations and testing shall be performed by qualified GE Healthcare personnel. The products involved (and the accompanying electrical installations) are highly sophisticated, and special engineering competence is required. In performing all electrical work on these products, GE will use its own specially trained field engineers. All of GE's electrical work on these products will comply with the requirements of the applicable electrical codes.

The purchaser of GE equipment shall only utilize qualified personnel (i.e., GE's field engineers, personnel of third-party service companies with equivalent training, or licensed electricians) to perform electrical servicing on the equipment.

### **IMPORTANT...X-RAY PROTECTION**

X-ray equipment, if not properly used, may cause injury. Accordingly, the instructions herein contained should be thoroughly read and understood by everyone who will use the equipment before you attempt to place this equipment in operation. The General Electric Company, Healthcare Group, will be glad to assist and cooperate in placing this equipment in use.

Although this apparatus incorporates a high degree of protection against x-radiation other than the useful beam, no practical design of equipment can provide complete protection. Nor can any practical design compel the operator to take adequate precautions to prevent the possibility of any persons carelessly exposing themselves or others to radiation.

It is important that anyone having anything to do with x-radiation be properly trained and fully acquainted with the recommendations of the National Council on Radiation Protection and Measurements as published in NCRP Reports available from NCRP Publications, 7910 Woodmont Avenue, Room 1016, Bethesda, Maryland 20814, and of the International Commission on Radiation Protection, and of any other local authorities, and take adequate steps to protect against injury.

The equipment is sold with the understanding that the General Electric Company, Healthcare Group, its agents, and representatives have no responsibility for injury or damage which may result from improper use of the equipment.

Various protective materials and devices are available. It is urged that such materials or devices be used.

### **OMISSIONS & ERRORS**

Customers, please contact your GE Sales or Service representatives.

GE personnel, please use the GEHC Itrack Process to report all omissions, errors, and defects in this publication.

This page is intentionally left blank.

---

# *Revision History*

---

Revision	Date	Reason for change
1	20 Aug, 2015	First Release

---

# List of Effected Pages

PAGES	REVISION	PAGES	REVISION
1 through 130	1		



# Table of Contents

---

<b>Preface Publication Conventions .....</b>	<b>23</b>
<b>Section 1.0 Safety &amp; Hazard Information .....</b>	<b>23</b>
1.1 Hazard Messages.....	23
1.2 Text Format of Signal Words.....	23
1.3 Symbols and Pictorials Used.....	24
<b>Section 2.0 Publication Conventions .....</b>	<b>25</b>
2.1 General Paragraph and Character Styles.....	25
2.2 Page Layout.....	26
2.3 Computer Screen Output/Input Text Character Styles .....	26
2.4 Buttons, Switches and Keyboard Inputs (Hard & Soft Keys).....	27
<b>Chapter 1 DICOM Conformance Statement .....</b>	<b>29</b>
<b>Section 1.0 INTRODUCTION.....</b>	<b>29</b>
1.1 OVERVIEW .....	29
1.2 OVERALL DICOM CONFORMANCE STATEMENT DOCUMENT STRUCTURE.....	30
1.3 INTENDED AUDIENCE.....	31
1.4 SCOPE AND FIELD OF APPLICATION.....	31
1.5 IMPORTANT REMARKS.....	32
1.6 REFERENCES .....	33
1.7 DEFINITIONS.....	33
1.8 SYMBOLS AND ABBREVIATIONS.....	33
<b>Section 2.0 NETWORK CONFORMANCE STATEMENT .....</b>	<b>34</b>
2.1 INTRODUCTION .....	34
2.2 IMPLEMENTATION MODEL .....	34
2.2.1 Application Data Flow Diagram .....	34
2.2.2 Functional Definition of AE's.....	36
2.2.3 Sequencing of Real-World Activities.....	39
2.3 AE SPECIFICATIONS.....	40
2.3.1 DICOM Server AE Specification .....	40
2.3.1.1 Association Establishment Policies .....	40
2.3.2 Worklist Server AE Specification .....	50
2.3.2.1 Association Establishment Policies .....	51
2.3.2.2 Association Acceptance Policy.....	54
2.3.3 Storage Commitment Server AE Specification .....	54
2.3.3.1 Association Establishment Policies .....	54
2.3.4 PPS Server AE Specification.....	57
2.3.4.1 Performed Procedure Step.....	57
2.4 COMMUNICATION PROFILES.....	59
2.4.1 Supported Communication Stacks (PS 3.8, PS 3.9) .....	59
2.4.2 OSI Stack.....	59
2.4.2.1 Physical Media Support.....	59
2.4.3 TCP/IP Stack .....	59
2.4.3.1 API.....	59
2.4.3.2 Physical Media Support.....	59

2.4.4	Point-to-Point Stack .....	59
2.5	EXTENSIONS / SPECIALIZATIONS / PRIVATIZATIONS.....	59
2.5.1	Standard Extended /Specialized/Private SOPs .....	59
2.5.2	Private Transfer Syntaxes .....	59
2.6	CONFIGURATION .....	60
2.6.1	AE Title/Presentation Address Mapping .....	60
2.6.2	Configurable Parameters .....	60
2.7	SUPPORT OF EXTENDED CHARACTER SETS .....	60
2.8	SECURITY PROFILES .....	60
<b>Section 3.0 MEDIA STORAGE CONFORMANCE STATEMENT.....</b>		<b>61</b>
3.1	INTRODUCTION.....	61
3.2	IMPLEMENTATION MODEL .....	61
3.2.1	Application Data Flow Diagram.....	61
3.2.2	Functional Definition of AE's .....	63
3.2.2.1	Functional Definition of the DICOM Media Server AE .....	63
3.2.3	Sequencing Requirements.....	63
3.2.4	File Meta Information Options (See PS3.10) .....	63
3.3	AE SPECIFICATIONS .....	64
3.3.1	DICOM CDR/CDROM SERVER AE Specification .....	64
3.3.1.1	File Meta Information for the DICOM CDR/DVDR/CDROM Application Entity 64	
3.3.1.2	Real-World Activities for the DICOM CDR/DVDR/CDROM Application Entity 64	
3.4	AUGMENTED AND PRIVATE APPLICATION PROFILES.....	65
3.5	EXTENSIONS, SPECIALIZATIONS, PRIVATIZATIONS OF SOP CLASSES & TRANSFER SYNTAXES 66	
3.5.1	Extensions, Specializations, and Privatizations of SOP Classes.....	66
3.5.1.1	SOP Specific Conformance Statement for SOP Media Storage Directory 66	
3.5.2	Private Transfer Syntax Specification .....	66
3.6	CONFIGURATION .....	66
3.7	SUPPORT OF EXTENDED CHARACTER SETS .....	66
<b>Section 4.0 DIGITAL X-RAY INFORMATION OBJECT IMPLEMENTATION..</b>		<b>67</b>
4.1	INTRODUCTION.....	67
4.2	DX IOD IMPLEMENTATION.....	67
4.3	DX ENTITY-RELATIONSHIP MODEL .....	67
4.3.1	Entity Descriptions .....	68
4.3.2	Acquisition Workstation Mapping of DICOM entities.....	68
4.4	IOD MODULE TABLE .....	69
4.4.1	Discovery XR656 GII and Discovery XR656 IOD MODULE TABLE.....	69
4.4.2	Optima XR646 and Definium 6000 IOD MODULE TABLE .....	70
4.5	INFORMATION MODULE DEFINITIONS .....	70
4.5.1	Common Patient Entity Modules.....	70
4.5.1.1	Patient Module .....	70
4.5.2	Common Study Entity Modules.....	71
4.5.2.1	General Study Module .....	71
4.5.3	Common Series Entity Modules.....	71
4.5.3.1	General Series Module .....	71
4.5.3.2	DX Series Module.....	72
4.5.4	Common Equipment Entity Modules.....	72
4.5.4.1	General Equipment Module .....	73

4.5.5	Common Image Entity Modules.....	73
4.5.5.1	General Image Module.....	73
4.5.5.2	Image Pixel Module.....	74
4.5.5.3	DX Anatomy Imaged Module .....	75
4.5.5.4	DX Image Module.....	75
4.5.5.5	DX Detector Module.....	76
4.5.5.6	X-ray Collimator Module.....	77
4.5.5.7	DX Positioning Module.....	77
4.5.5.8	X-ray Acquisition Dose Modules .....	78
4.5.5.9	X-ray Generation Module .....	80
4.5.5.10	X-ray Filtration Module .....	81
4.5.5.11	X-ray Grid Module .....	81
4.5.5.12	Overlay Plane module:.....	81
4.5.5.13	VOI LUT Module.....	82
4.5.5.14	Acquisition Context Module.....	82
4.5.5.15	SOP Common Module .....	83
4.5.5.16	Icon Image module.....	83
4.5.5.17	Discovery XR656 Frame of Reference Module.....	83
4.5.5.18	Discovery XR656 X-ray Tomography Acquisition Module.....	84
4.5.5.19	Discovery XR656 XA Positioner Module .....	84
4.5.5.20	Discovery XR656 Image Plane Module.....	84
4.5.6	Application Module (Private Module).....	85
4.5.6.1	Discovery XR656 GII and Discovery XR656 Application Module Table 85	
4.5.6.2	Optima XR646 and Definium 6000 Application Module Table .....	87
4.6	PRIVATE DATA DICTIONARY.....	88
4.6.1	Discovery XR656 GII and Discovery XR656 Private Attributes Table .....	88
4.6.2	Optima XR646 and Definium 6000 Private Attributes Table.....	90

**Section 5.0 STUDY ROOT QUERY/RETRIEVE INFORMATION MODEL**

<b>DEFINITION .....</b>	<b>92</b>
5.1 INTRODUCTION .....	92
5.2 STUDY ROOT INFORMATION MODEL DESCRIPTION.....	92
5.3 STUDY ROOT INFORMATION MODEL ENTITY-RELATIONSHIP MODEL .....	92
5.3.1 Entity Descriptions.....	93
5.3.2 Acquisition Workstation Mapping of DICOM entities .....	93
5.4 INFORMATION MODEL KEYS .....	93
5.4.1 Supported Matching.....	93
5.4.2 Study Level .....	93
5.4.3 Series Level .....	94
5.4.4 Image Level .....	94
5.5 PRIVATE DATA DICTIONARY.....	94

**Section 6.0 MODALITY WORKLIST INFORMATION MODEL DEFINITION .. 95**

6.1 INTRODUCTION .....	95
6.2 MODALITY WORKLIST INFORMATION MODEL DESCRIPTION .....	95
6.3 MODALITY WORKLIST INFORMATION MODEL ENTITY-RELATIONSHIP MODEL ...	95
6.3.1 Entity Descriptions.....	96
6.3.1.1 Scheduled Procedure Step .....	96
6.3.1.2 Requested Procedure Entity Description .....	96
6.3.1.3 Imaging Service Request Entity Description .....	97
6.3.1.4 Visit Entity Description.....	97
6.3.1.5 Patient Entity Description .....	97

6.3.2	Acquisition Workstation Mapping of DICOM entities.....	97
6.4	INFORMATION MODEL MODULE TABLE .....	97
6.5	INFORMATION MODEL KEYS.....	98
6.5.1	Supported Matching .....	98
6.5.2	Scheduled Procedure Step Entity .....	98
6.5.2.1	SOP Common Module.....	98
6.5.2.2	Scheduled Procedure Step Module.....	99
6.5.3	Requested Procedure Entity .....	100
6.5.3.1	Requested Procedure Module .....	100
6.5.4	Imaging Service Request Entity .....	101
6.5.4.1	Imaging Service Request Module.....	101
6.5.5	Visit Entity .....	101
6.5.5.1	Visit Identification.....	101
6.5.5.2	Visit Status.....	101
6.5.5.3	Visit Relationship .....	101
6.5.5.4	Visit Admission .....	101
6.5.6	Patient Entity .....	101
6.5.6.1	Patient Relationship.....	101
6.5.6.2	Patient Identification .....	102
6.5.6.3	Patient Demographic .....	102
6.5.6.4	Patient Medical .....	102
6.6	PRIVATE DATA DICTIONARY .....	102
<b>Section 7.0 NETWORK PRINT SCU CONFORMANCE STATEMENT .....</b>		<b>103</b>
7.1	INTRODUCTION.....	103
7.2	IMPLEMENTATION MODEL .....	103
7.2.1	Application Data Flow Diagram.....	103
7.2.2	Functional Definition of AE's .....	104
7.2.3	Sequencing of Real-World Activities .....	104
7.2.3.1	Manual Image Print.....	104
7.2.3.2	Automatic Image Print .....	104
7.3	AE SPECIFICATIONS .....	105
7.3.1	DICOM Print SCU AE Specification .....	105
7.3.1.1	Association Establishment Policies .....	105
7.3.1.2	Association Initiation Policy .....	106
7.4	COMMUNICATION PROFILES .....	108
7.4.1	Supported Communication Stacks (PS 3.8, PS 3.9).....	108
7.4.2	OSI Stack .....	108
7.4.3	TCP/IP Stack.....	108
7.4.3.1	API .....	108
7.4.3.2	Physical Media Support .....	108
7.4.4	Point-to-Point Stack .....	108
7.5	EXTENSIONS / SPECIALIZATIONS / PRIVATIZATIONS.....	108
7.5.1	Standard Extended /Specialized/Private SOP Classes .....	108
7.5.2	Private Transfer Syntaxes.....	108
7.6	CONFIGURATION .....	109
7.6.1	AE Title/Presentation Address Mapping .....	109
7.6.2	Configurable Parameters .....	109
7.7	SUPPORT OF EXTENDED CHARACTER SETS .....	109
<b>Section 8.0 PRINT MANAGEMENT SOP CLASS DEFINITION.....</b>		<b>110</b>
8.1	INTRODUCTION.....	110
8.2	PRINT MANAGEMENT SOP CLASS DEFINITIONS .....	110

8.2.1	Basic Film Session SOP Class .....	110
8.2.1.1	IOD Description .....	110
8.2.1.2	DIMSE Service Group .....	111
8.2.2	Basic Film Box SOP Class .....	112
8.2.2.1	IOD Description .....	112
8.2.2.2	DIMSE Service Group .....	113
8.2.3	Image Box SOP Classes .....	115
8.2.3.1	Basic Grayscale Image Box SOP Class.....	115
8.2.3.2	IOD Description .....	117
8.2.3.3	DIMSE Service Group .....	117
8.2.4	Print Job SOP Class .....	118
8.2.5	Basic Annotation Box SOP Class .....	118
8.2.6	Image Overlay Box SOP Class.....	118

**Section 9.0 STORAGE COMMITMENT PUSH MODEL SOP CLASS**

<b>DEFINITION .....</b>	<b>119</b>	
9.1	INTRODUCTION .....	119
9.2	STORAGE COMMITMENT PUSH MODEL SOP CLASS DEFINITION.....	119
9.2.1	IOD Description .....	119
9.2.1.1	STORAGE COMMITMENT MODULE.....	119
9.2.2	DIMSE Service Group .....	120
9.2.3	Operations .....	120
9.2.3.1	Action Information .....	120
9.2.3.2	Service Class User Behavior.....	120
9.2.3.3	Status Codes.....	121
9.2.4	Notifications .....	121
9.2.4.1	Event Information .....	121
9.2.4.2	Service Class User Behavior.....	122
9.2.4.3	Status Codes.....	122

**Section 10.0 MODALITY PERFORMED PROCEDURE STEP**

<b>IMPLEMENTATION.....</b>	<b>123</b>	
10.1	MODALITY PERFORMED PROCEDURE STEP MODULE TABLE .....	123
10.2	MODALITY PERFORMED PROCEDURE STEP MODULE DEFINITIONS.....	123
10.2.1	SOP Common Module.....	123
10.2.2	Performed Procedure Step Relationship Module .....	123
10.2.3	Performed Procedure Step Information Module .....	124
10.2.4	Image Acquisition Results Module.....	125
10.2.5	Radiation Dose Module .....	126
10.2.6	Billing and Material Management Codes Module .....	127
10.3	STANDARD EXTENDED AND PRIVATE DATA ATTRIBUTES .....	127
10.4	STANDARD EXTENDED AND PRIVATE CONTEXT GROUPS.....	127



---

# Preface Publication Conventions

---

Standardized conventions for representing information is a uniform way of communicating information to a reader in a consistent manner. Conventions are used so that the reader can easily recognize the actions or decisions that must be made. There are a number of character and paragraph styles used in this publication to accomplish this task. Please become familiar with them before proceeding forward.

It is important that you read and understand hazard statements, and not just ignore them.

## Section 1.0 Safety & Hazard Information

Proper product safety labeling allows a person to safely use or service a product. The format and style for safety communications reflected in this publication represents the harmonization of IEC/ISO 3864 and ANSI Z535 standards.

Within this publication, different paragraph and character styles are used to indicate potential hazards. Paragraph prefixes, such as hazard, caution, danger and warning, are used to identify important safety information. Text (Hazard) styles are applied to the paragraph contents that are applicable to each specific safety statement.

### 1.1 Hazard Messages

Any action that will, or could potentially cause personal injury will be preceded by the safety alert symbol and an appropriate signal word. The safety alert symbol is the triangle with an exclamation mark within it. It is always used next to the signal word to indicate the severity of the hazard. Together, they are used to indicate a hazard exists.

Signal words describe the severity of possible human injuries that may be encountered. The alert symbol and signal word are placed immediately before any paragraph they affect. Safety information includes:

- 1.) Signal Word - The seriousness level of the hazard.
- 2.) Symbol or Pictorial - The consequence of interaction with the hazard.
- 3.) Word Message:
  - a.) The nature of the hazard (i.e. the type of hazard).
  - b.) How to avoid the hazard.

The safety alert symbol is not used when an action can only cause equipment damage.

### 1.2 Text Format of Signal Words

**DANGER - INDICATES AN IMMINENTLY HAZARDOUS SITUATION WHICH, IF NOT AVOIDED, WILL RESULT IN DEATH OR SERIOUS INJURY. THIS SIGNAL WORD IS TO BE LIMITED TO THE MOST EXTREME SITUATIONS.**

**WARNING - INDICATES A POTENTIALLY HAZARDOUS SITUATION WHICH, IF NOT AVOIDED, COULD RESULT IN DEATH OR SERIOUS INJURY.**

**Caution - Indicates a potentially hazardous situation which, if not avoided, may result in minor or moderate injury. It may also be used to alert against unsafe practices.**



































**NOTICE - Indicates information or a company policy that relates directly or indirectly to the safety of personnel or protection of property. This signal word is associated directly with a**

hazard or hazardous situation and is used in place of 'DANGER,' 'WARNING,' or 'CAUTION.' It can include:

- Destruction of a disk drive
- Potential for internal mechanical damage, such as to a X-ray tube

### 1.3 Symbols and Pictorials Used

The following Symbols and Pictorials may be used in this publication. These graphical icons (symbols) may be used to make you aware of specific types of hazards that could possibly cause harm.

NOTICE	CAUTION	WARNING	DANGER	
 keep_up	 magnetic	 biohazard	 compressgas	 ppe-hearing
 fragile	 impact	 corrosive	 heavyobject	 ppe-2people
 static_elec	 heat	 general	 laser	 ppe-respiratory
 keep_dry	 pinch	 radiation	 poisongas	 ppe-loto
 general	 explosive	 electrical	 flammable	 ppe-eye
 torque	 crush/mechanical	 tipping	 Read Manual	 ppe-gloves
 ce	 instuction	 poisonmatl	 entanglement	 instuction



---

## Section 2.0 Publication Conventions

### 2.1 General Paragraph and Character Styles

Prefixes are used to highlight important non-safety related information. Paragraph prefixes (such as Purpose, Example, Comment or Note) are used to identify important but non-safety related information. Text styles are also applied to text within each paragraph modified by the specific prefix.

#### **EXAMPLES OF PREFIXES USED FOR GENERAL INFORMATION:**

**Purpose:** Introduces and provides meaning as to the information contained within the chapter, section or subsection (such as used at the beginning this chapter, for example).

**Note:** Conveys information that should be considered important to the reader.

**Example:** Used to make the reader aware that the paragraph(s) that follow are examples of information possibly stated previously.

**Comment:** *Represents “additional” information that may or may not be relevant to your situation.*

## 2.2 Page Layout

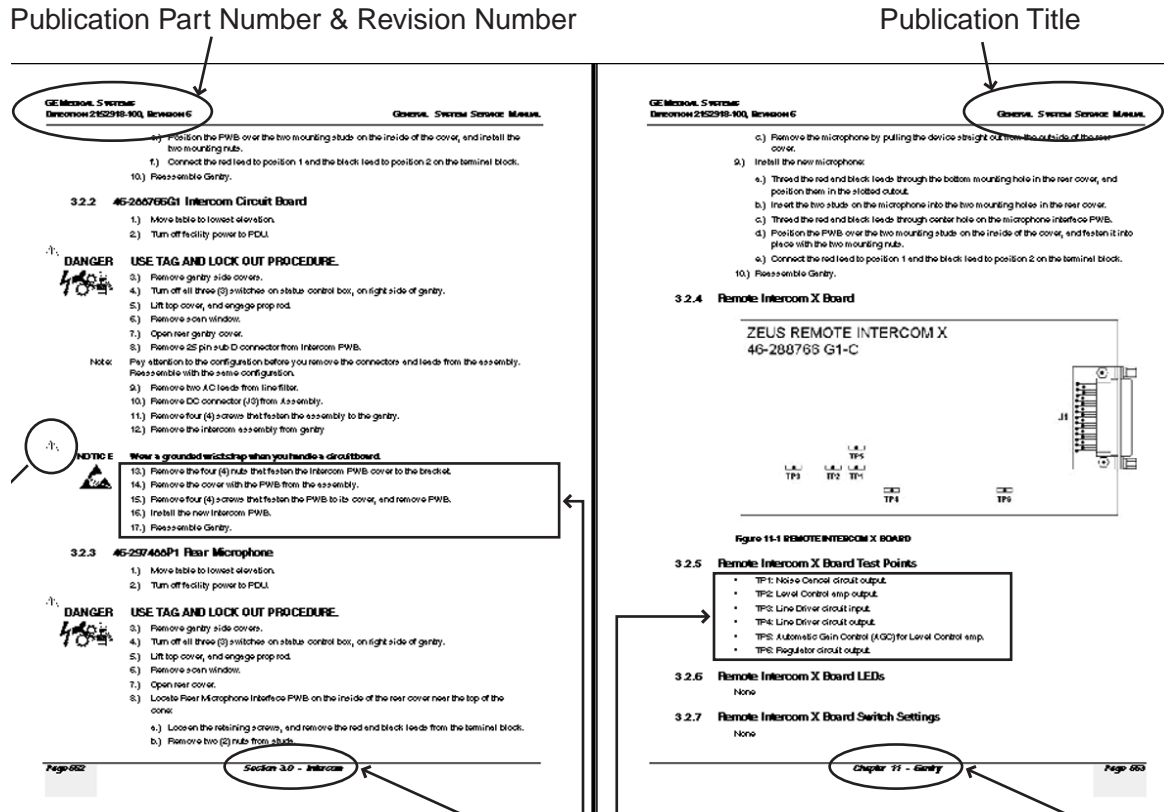

The current section and its title are always shown in the footer of the left (even) page.

An exclamation point in a triangle is used to indicate important information to the user.

Paragraphs preceded by **Alphanumeric** characters (e.g. numbers) contain information that must be followed in a **specific order**.

The current chapter and its title are always shown in the footer of the right (odd) page.

Paragraphs preceded by a **symbol** (e.g. bullets) contain information that has **no specific order**.

**Figure 0-1 Definium 6000 Component Identification**

Headers and footers in this publication are designed to allow you to quickly identify your location. The document part number and revision number appear in every header on every page. Odd numbered page footers indicate the current chapter, its title and current page number. Even numbered page footers show the current section and its title, as well as the current page number.

## 2.3 Computer Screen Output/Input Text Character Styles

Within this publication, mono-spaced character styles (fonts) are used to indicate computer text that is either screen input or output. Mono-spaced fonts, such as courier, are used to indicate text direction. When you type at your keyboard, you are generating computer input. Occasionally you will see the math operator “greater-than” and “less-than” symbols used to indicate the start and finish of variable output. When reading text generated by the computer, you are reading it as computer generated output. In addition to direction, characters are italicized (e.g. *italics*) to indicate information specific to your system or site.

Example: This paragraph's font represents computer generated screen "fixed" output.  
Fixed Output Its output is fixed from the sense that it does not vary from application to application. It is the most commonly used style used to indicate filenames, paths and text that do not change from system to system. The character style used is a fixed width such as courier.

Example: *This paragraph's font represents computer screen output that is "variable". It is used to represent output that varies from application to application or system to system. Variable output is sometimes found placed between greater-than and less-than operators for clarification. For example: <variable\_ouput> or <3.45.120.3>. In both cases, the < and > operators are not part of the actual input.*  
Variable Output

Example: This paragraph's font represents fixed input. It is computer input that is typed-in via the keyboard. Typed input that does not vary from application to application or system to system. Fixed text the user is required to supply as input. For example: `cd /usr/3p`  
Fixed Input

Example: *This paragraph's font represents computer input that can vary from application to application or system to system. With variable text, the user is required to supply system dependent input or information. Variable input sometimes is placed between greater-than and less-than operators. For example: <variable\_input>. In these cases, the (<>) operators would be dropped prior to input. For example: `ypcat hosts | grep <3.45.120.3>` would be typed into the computer as*  
`ypcat hosts | grep 3.45.120.3`  
*without the greater-than and less-than operators.*  
Variable Input

## 2.4 Buttons, Switches and Keyboard Inputs (Hard & Soft Keys)

Different character styles are used to indicate actions requiring the reader to press either a hard or soft button, switch or key. Physical hardware, such as buttons and switches, are called hard keys because they are hard wired or mechanical in nature. A keyboard or on/off switch would be a hard key. Software or computer generated buttons are called soft keys because they are software generated. Software driven menu buttons are an example of such keys. Soft and hard keys are represented differently in this publication.

Example: A power switch **ON/OFF** or a keyboard key like **ENTER** is indicated by applying a character style that uses both over and under-lined bold text. This is a hard key.  
Hard Keys

Example: Whereas the computer MENU button that you would click with your mouse or touch with your hand uses over and under-lined regular text. This is a soft key.  
Soft Keys

This page is intentionally left blank.

---

# Chapter 1 DICOM Conformance Statement

---

## Section 1.0 INTRODUCTION

### 1.1 OVERVIEW

This DICOM Conformance Statement is divided into Sections as described below:

**Section 1 (Introduction)**, which describes the overall structure, intent, and references for this Conformance Statement

**Section 2 (Network Conformance Statement)**, which specifies the GEHC equipment compliance to the DICOM requirements for the implementation of Networking features.

**Section 3 (Media Storage Conformance Statement)**, which specifies the GEHC equipment compliance to the DICOM requirements for the implementation of Media Storage features.

**Section 4 (Digital X-ray Information Object Implementation)**, which specifies the GEHC equipment compliance to DICOM requirements for the implementation of a Digital X-ray Information Object Implementation feature.

**Section 5 (Study Root Query/Retrieve Information Model)**, which specifies the GEHC equipment compliance to DICOM requirements for the implementation of the Study Root Query/Retrieve Information Model feature.

**Section 6 (Modality Worklist Information Model)**, which specifies the GEHC equipment compliance to DICOM requirements for the implementation of Basic Worklist Management Service feature.

**Section 7 (Network Print SCU Conformance Statement)**, which specifies the GEHC equipment compliance to DICOM requirements for the implementation of the Network Print feature.

**Section 8 (Network Print Management SOP Class Definition)**, which specifies the GEHC equipment compliance to DICOM requirements for the implementation of the Network Print Management SOP Class.

**Section 9 (Storage Commitment Push Model)**, which specifies the GEHC equipment compliance to DICOM requirements for the implementation of the Storage Commitment Push Service feature.

**Section 10 (Performed Procedure Step SCU)**, which specifies the GEHC equipment compliance to DICOM requirements for the implementation of Performed Procedure Step (PPS) SCU features.

## 1.2 OVERALL DICOM CONFORMANCE STATEMENT DOCUMENT STRUCTURE

The Documentation Structure of the GEHC Conformance Statements and their relationship with the DICOM V3.0 Conformance Statements is shown in the Illustration below.

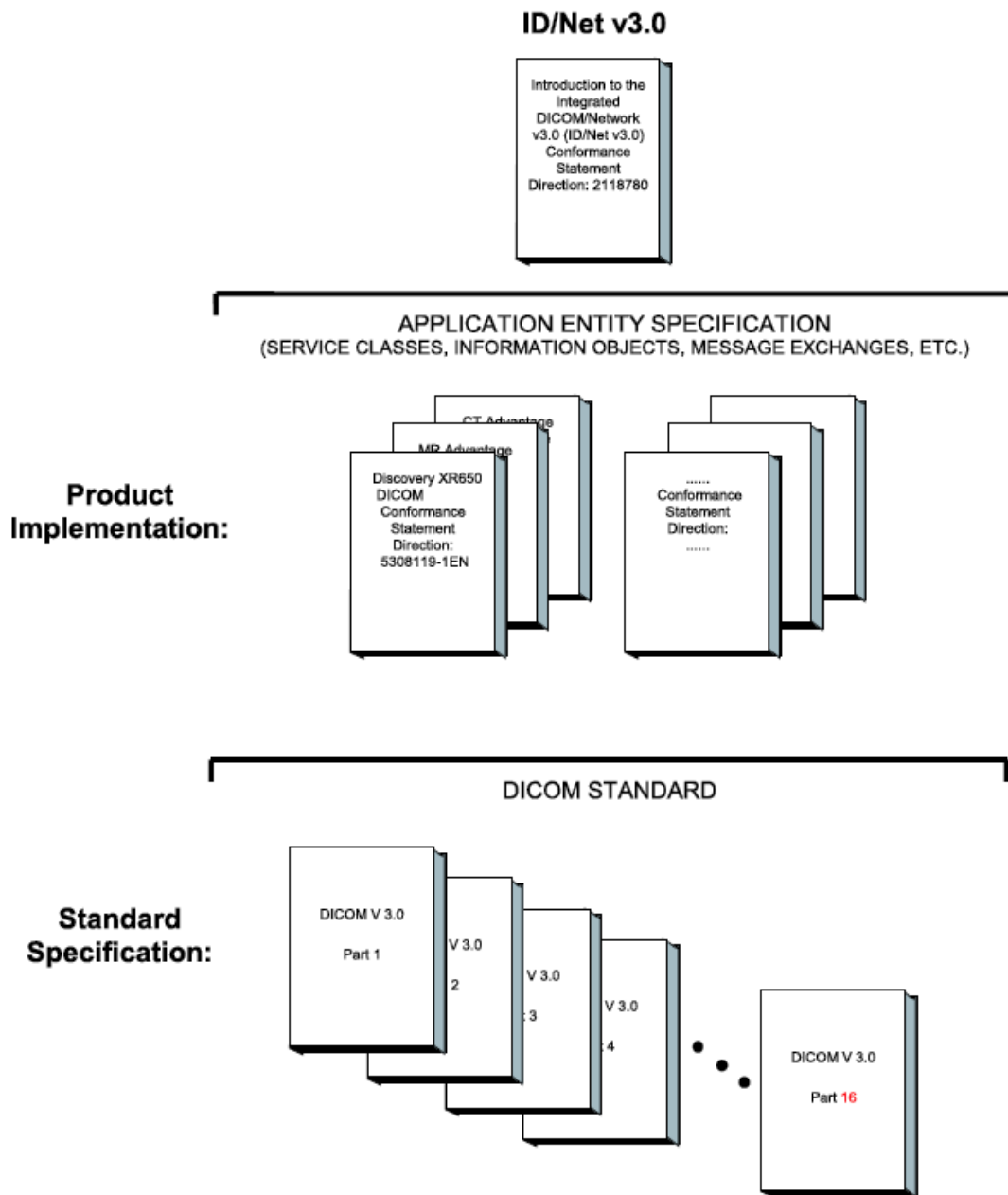

This document specifies the DICOM implementation. It is entitled:

- Discovery XR656 GII, Optima XR646, Definium 6000 (V), Discovery XR656
- DICOM Conformance Statement
- Direction 5643866-1EN

This DICOM Conformance Statement documents the DICOM Conformance Statement and Technical Specification required to inter-operate with the GEHC network interface. Introductory information, which is applicable to all GEHC Conformance Statements, is described in the document:

- Introduction to the Integrated DICOM/Network v3.0 (ID/Net v3.0)
- Conformance Statement
- Direction: 2118780.

This Introduction familiarizes the reader with DICOM terminology and general concepts. It should be read prior to reading the individual products' GEHC Conformance Statements.

The GEHC Conformance Statement, contained in this document, also specifies the Lower Layer communications that it supports (e.g., TCP/IP). However, the Technical Specifications are defined in the DICOM Part 8 standard.

For more information including Network Architecture and basic DICOM concepts, please refer to the Introduction.

For more information regarding DICOM, copies of the Standard may be obtained on the Internet at <http://medical.nema.org>. Comments on Standard may be addressed to:

- DICOM Secretariat
- NEMA
- 1300 North 17th Street, Suite 1847
- Rosslyn, VA 22209
- USA
- Phone: +1.703.841.3200

### 1.3 INTENDED AUDIENCE

The reader of this document is concerned with software design and/or system integration issues. It is assumed that the reader of this document is familiar with the DICOM Standards and with the terminology and concepts which are used in that standard.

If readers are unfamiliar with DICOM terminology they should first refer to the document listed below, then read the DICOM Standard itself, prior to reading this DICOM Conformance Statement document.

- Introduction to the Integrated DICOM/Network v3.0 (ID/Net v3.0)
- Conformance Statement
- Direction: 2118780

### 1.4 SCOPE AND FIELD OF APPLICATION

It is the intent of this document, in conjunction with the Introduction to the Integrated DICOM/Network v3.0 (ID/Net v3.0) Conformance Statement, Direction: 2118780, to provide an unambiguous specification for GEHC implementations. This specification, called a Conformance Statement, includes a DICOM V3.0 Conformance Statement and is necessary to ensure proper processing and interpretation of GEHC medical data exchanged using DICOM V3.0. The GEHC Conformance Statements are available to the public.

The reader of this DICOM Conformance Statement should be aware that different GEHC devices are capable of using different Information Object Definitions. For example, a GEHC CT Scanner may send images using the CT Information Object, MR Information Object, Secondary Capture Object, etc.

Included in this DICOM Conformance Statement are the Module Definitions which define all data elements used by this GEHC implementation. If the user encounters unspecified private data elements while parsing a GEHC Data Set, the user is well advised to ignore those data elements (per the DICOM standard). Unspecified private data element information is subject to change without notice. If, however, the device is acting as a "full fidelity storage device", it should retain and re-transmit all of the private data elements that are sent by GEHC devices.

## 1.5 IMPORTANT REMARKS

The use of these DICOM Conformance Statements, in conjunction with the DICOM Standards, is intended to facilitate communication with GE imaging equipment. However, by itself, it is not sufficient to ensure that interoperability will be successful. The user (or user's agent) needs to proceed with caution and address at least four issues:

- **Integration** - The integration of any device into an overall system of interconnected devices goes beyond the scope of standards (DICOM V3.0), and of this introduction and associated DICOM Conformance Statements when interoperability with non-GE equipment is desired. The responsibility to analyze the applications requirements and to design a solution that integrates GE imaging equipment with non-GE systems is the user's responsibility and should not be underestimated. The user is strongly advised to ensure that such an integration analysis is correctly performed.
- **Validation** - Testing the complete range of possible interactions between any GE device and non-GE devices, before the connection is declared operational, should not be overlooked. Therefore, the user should ensure that any non-GE provider accepts full responsibility for all validation required for their connection with GE devices. This includes the accuracy of the image data once it has crossed the interface between the GE imaging equipment and the non-GE device and the stability of the image data for the intended applications. Such a validation is required before any clinical use (diagnosis and/or treatment) is performed. It applies when images acquired on GE imaging equipment are processed/displayed on a non-GE device, as well as when images acquired on non-GE equipment are processed/displayed on a GE console or workstation.
- **Future Evolution** - GE understands that the DICOM Standard will evolve to meet the user's growing requirements. GE is actively involved in the development of the DICOM Standard. DICOM will incorporate new features and technologies and GE may follow the evolution of the Standard. The GEHC protocol is based on DICOM as specified in each DICOM Conformance Statement. Evolution of the Standard may require changes to devices that have implemented DICOM. In addition, GE reserves the right to discontinue or make changes to the support of communications features (on its products) reflected on by these DICOM Conformance Statements. The user should ensure that any non-GE provider, which connects with GE devices, also plans for the future evolution of the DICOM Standard. Failure to do so will likely result in the loss of function and/or connectivity as the DICOM Standard changes and GE Products are enhanced to support these changes.
- **Interaction** - It is the sole responsibility of the non-GE provider to ensure that communication with the interfaced equipment does not cause degradation of GE imaging equipment performance and/or function.



## 1.6 REFERENCES

A list of references that is applicable to all GEHC Conformance Statements is included in the Introduction to the Integrated DICOM/Network v3.0 (ID/Net v3.0) Conformance Statement, Direction: 2118780.

The information object implementation refers to DICOM PS 3.3 (Information Object Definition)

## 1.7 DEFINITIONS

A set of definitions which is applicable to all GEHC Conformance Statements is included in the Introduction to the Integrated DICOM/Network v3.0 (ID/Net v3.0) Conformance Statement, Direction: 2118780.

## 1.8 SYMBOLS AND ABBREVIATIONS

A list of symbols and abbreviations which is applicable to all GEHC Conformance Statements is included in the Introduction to the Integrated DICOM/Network v3.0 (ID/Net v3.0) Conformance Statement, Direction: 2118780.

## Section 2.0 NETWORK CONFORMANCE STATEMENT

### 2.1 INTRODUCTION

This section of the DICOM Conformance Statement specifies the compliance to DICOM conformance requirements for the relevant Networking features on this GEHC product. Note that the format of this section strictly follows the format defined in DICOM Standard PS 3.2 (Conformance). Please refer to that part of the standard while reading this section.

The details of the DICOM conformance related to other Information Objects and Information Models supported by this product are included in subsequent sections of this DICOM Conformance Statement.

The product is an Integrated Digital X-ray Imaging System:

It uses DICOM services to export/import images to/from remote workstations.

It uses DICOM Storage Commitment service to transfer ownership of images to a remote workstation supporting storage commitment such as an archive system.

It allows a user to query for and display DICOM modality worklist information from a remote hospital or radiology department information system computer and send back MPPS to the remote hospital information system. For example, a user may wish to query for all procedures scheduled to be performed on the system. In this situation, Acquisition Workstation is providing the DICOM Modality Worklist SOP Class service as a service class user (SCU).

### 2.2 IMPLEMENTATION MODEL

#### 2.2.1 Application Data Flow Diagram

The Basic and Specific Application models for this device are shown in the following Illustration:

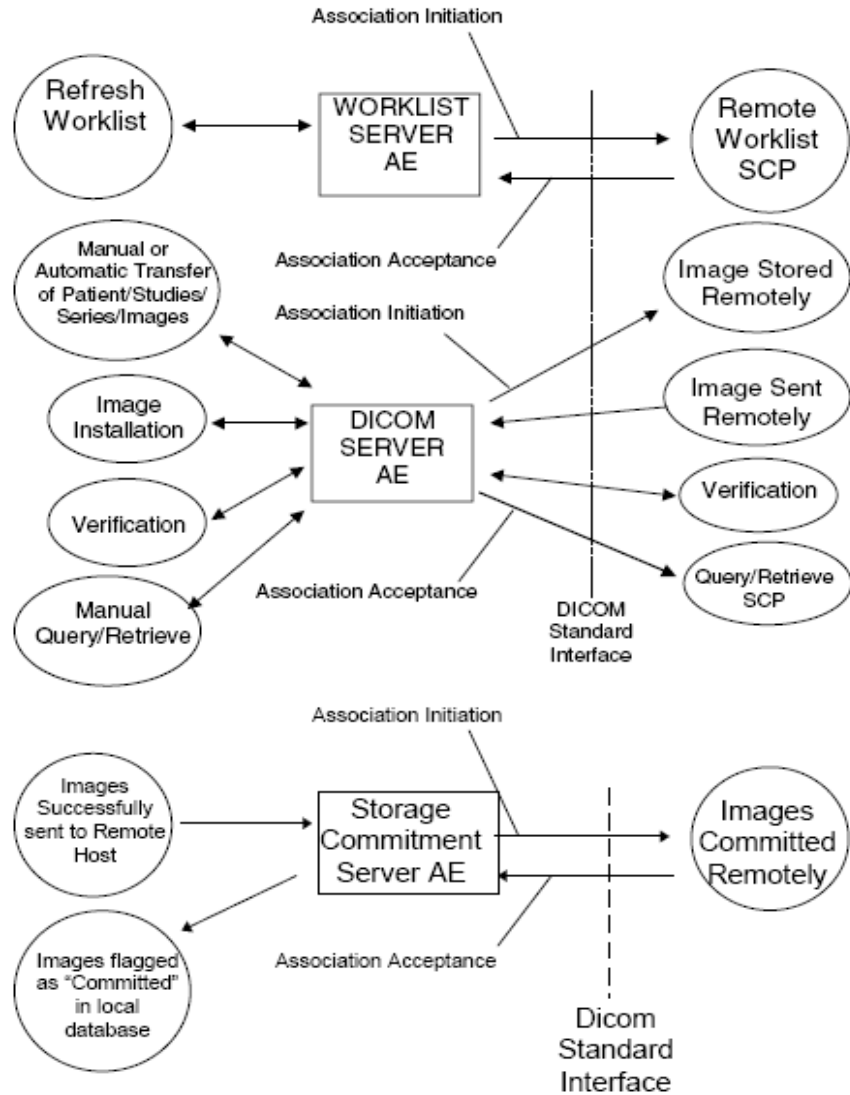

**Note:** Please also refer to sections 3 and 7 of the current document for Media Storage and Network Print Management SCU Conformance Statement.

The DICOM 'Performed Procedure Step' Service is provided by the PPS Server AE. The PPS Server AE is commanded to perform Performed Procedure Step Services either automatically or through the User Interface.

The basic application models for the feature are shown in the following illustration:

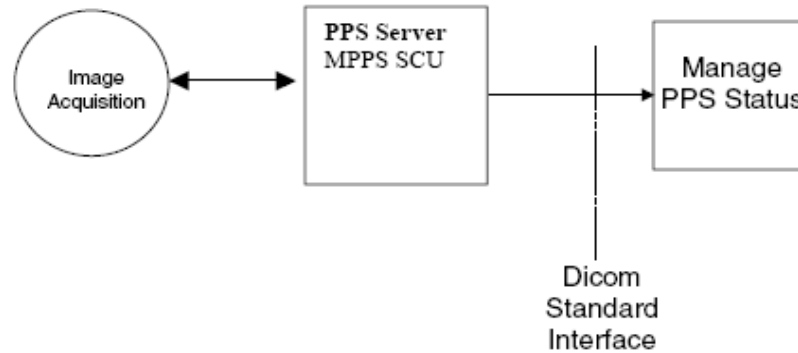

## 2.2.2 Functional Definition of AE's

### DICOM SERVER AE:

The DICOM SERVER Application Entity (AE) is an application that handles DICOM protocol communication. DICOM SERVER AE is automatically brought up when the Acquisition Workstation is powered on.

The DICOM SERVER AE is invoked by the following Real World Activities:

- Manual Transfer of Patients/Studies/Series/Images from the Acquisition Workstation to a Remote Host.

For this operation, the operator selects patients, studies, series or images on the console browser and then sends the selected patients, studies, series or images on to one or several remote DICOM AE by a drag and drop on the icon that represents the wanted remote DICOM AE.

All remote DICOM AE must be manually configured on the Acquisition Workstation by an operator or by a field engineer.

The declaration of remote DICOM AE is done through the "NETWORK MANAGEMENT" under Utilities.

- Automatic transfer of Images from the Acquisition Workstation to a Remote Host.

For this operation, the transfer of images is triggered automatically. When Auto- Push is ON and Auto Tag is ON, all images generated during an acquisition session are automatically sent to the defined auto-push remote hosts when the user closes the exam. Only images that satisfy Quality-Check criteria are autopushed.

The default value of the Quality-Check is set by the user through the Utilities->Preferences->IMAGE MANAGEMENT.

The setting of Auto-Push status (ON/OFF) and Auto-Push remote host is done through the Utilities->Preferences->"IMAGE MANAGEMENT".

The visualization of the transfer status is done on the Transfer Log window.

- Images Sent Remotely from a Remote DICOM AE to the Acquisition Workstation.

**Note: When images are installed in the local database, they are displayed in the Acquisition Workstation browser. Although AWS can receive DX, MG and SC modality images, only DX images can be correctly displayed in the viewer of AWS.**

- Manual Query/Retrieve

For this operation, the operator queries a remote database to obtain a list of data at Patient/Study/Series/Image by clicking on the icon that represents the wanted remote DICOM AE. Once the remote browser is displayed, the operator can retrieve images of the SOP Classes supported by the Acquisition Workstation from the remote DICOM AE and selecting the Local DB as the destination.

The query is selective based on criteria described below in the document.

The DICOM SERVER AE initiates the following operations:

- Access to patient demographics and pixel data in the local database.
- Build a DICOM format data set.
- Initiate a DICOM association to send DICOM SOP Classes to a remote DICOM AE.
- Initiate a DICOM association to ask for remote patient demographics.
- Initiate a DICOM association to ask for transmit images from a remote DICOM AE to Acquisition Workstation.

The DICOM SERVER AE waits for association requests from Remote AE:

- Answer to DICOM associations transmitting DICOM SOP Classes to be stored on the Acquisition Workstation.
- Answer to DICOM associations transmitting Verification SOP Class to the Acquisition Workstation.

#### WORKLIST SERVER AE:

The WORKLIST SERVER AE is automatically brought up when the Acquisition Workstation is powered on.

The remote Worklist SCP must be manually configured on the Acquisition Workstation. The configuration of remote Worklist SCP is done through the UTILITIES-> NETWORK CONNECTIONS.

The WORKLIST SERVER AE is invoked by the real world activity: "Refresh Worklist".

For this operation, the user clicks on the REFRESH WORKLIST button of the Worklist screen in order to obtain latest modality worklist from the RIS. The WORKLIST SERVER sends a query defined by the user to remote AE's and returns the results to the user interface.

The WORKLIST SERVER AE initiates the following functions:

- Build the Worklist query according to the criteria defined by the user in the Query Definition Window.
- Send the query to Worklist Provider: Initiates a DICOM association with the Worklist Provider. If the remote Worklist Provider accepts a presentation context applicable to modality worklist, the WORKLIST SERVER AE issues a modality worklist query request via the C-FIND service.

STORAGE COMMITMENT SERVER AE:

The STORAGE COMMITMENT SERVER AE is automatically brought up when the Acquisition Workstation is powered on.

To enable this operation on the on the Acquisition Work Station, the operator selects the host from the Network Host list and selects the Storage Commitment option. The host information has also to be filled out.

The STORAGE COMMITMENT SERVER AE is invoked by the Real World Activities: "Images successfully sent to a remote host supporting Storage Commitment".

The declaration of remote host supporting Storage Commitment is done on the NETWORK CONNECTIONS options.

When STORAGE COMMITMENT SERVER AE receives a successful commitment for images, it flags them as "Committed" in the local database.

The STORAGE COMMITMENT SERVER AE initiates the following operations:

- Initiate a DICOM association to ask a remote host (Storage Commitment SCP) storage commitment on specific images. The STORAGE COMMITMENT SERVER AE waits for association requests from Remote Storage Commitment AE:
  
- Answer to DICOM associations transmitting Storage Commitment Notification (N-EVENT-REPORT)

PPS SERVER AE:

1. The PPS Server AE is implemented as an application process on the Acquisition host computer. It runs as a daemon serving requests from other applications to send the PPS information to the remote AE.

To enable this operation on the Acquisition Work Station, the operator selects the remote Worklist SCP from the Host list and enables MPPS option from the preferences.

2. The PPS Server AE initiates the following functions:

- Start PPS
- Complete PPS
- Discontinue PPS

3. Start PPS: Initiates a DICOM association in order to create a DICOM Modality Performed Procedure Step SOP instance in the remote AE. If the remote AE accepts a presentation context applicable to Modality performed Procedure Step, the PPS Server AE will issue a request to create the SOP instance in the remote AE via the N-CREATE Service.

4. Complete PPS: Initiates a DICOM association in order to update a DICOM Modality Performed Procedure Step instance that is already created with the remote AE. If the remote AE accepts a presentation context applicable to Modality Performed Procedure Step, the PPS Server AE will issue a request to update the SOP instance in the remote AE via the N-SET service. The PPS Status is set to 'COMPLETED'.

5. Discontinue PPS: Initiates DICOM associations in order to update a DICOM Modality Performed Procedure Step instance that is already created with the remote AE. If the remote AE accepts a presentation context applicable to Modality Performed Procedure Step, the PPS Server AE will issue a request to update the SOP instance in the remote AE via the N-SET service. The PPS Status is set to 'DISCONTINUED'.

### 2.2.3 Sequencing of Real-World Activities

#### DICOM SERVER AE:

In case of automatic transfer of images to a remote host:

1. User set Auto-Push ON and defines auto-push remote hosts.
2. User starts an exam.
3. User acquires images.
4. User checks quality of each images and sets the QC flag for each image to "OK to send" or "Not OK to send". The default flag setting is configured through Medical Applications Preferences from the Browser Toolkit menu.
5. User clicks on CLOSE EXAM.
6. Images flagged as "OK to send" are sent to auto-push remote hosts.

#### WORKLIST SERVER AE:

The user will usually refresh the Worklist before the image acquisition in order to get the very latest information from the RIS.

1. Upon user request, the system initiates a modality worklist query (as a modality worklist SCU) to the modality worklist SCP with a given set of query parameters.
2. The modality worklist SCP returns responses that match the query parameters.
3. Items from the returned worklist responses are filtered according to the query parameters
4. Only the items matching the query parameters are presented to the user.
5. Each item of the returned worklist responses selected for image acquisition is included in acquired DICOM images related to the responses.

#### STORAGE COMMITMENT SERVER AE:

1. The user selects the images and sends them to a remote host.
2. If the remote host was declared on the system as Storage Commitment Provider and if the images are successfully sent, then N-ACTION-RQ request is sent to Storage Commitment Provider
3. Waits for N-ACTION-RSP from Storage Commitment Provider
4. On reception of failure in N-ACTION-RSP, Storage Commitment AE logs the error, displays a pop-up and stops.
5. On reception of success, Storage Commitment AE is ready to receive at any time from Storage Commitment Provider the N-EVENT-REPORT-RQ notification.
6. On reception of N-EVENT-REPORT-RQ notification from Storage Commitment Provider, system flags the images in the database as committed.
7. When all images are flagged, Storage Commitment AE sends a N-EVENTREPORT- RSP to the Storage Commitment Provider.

#### PPS SERVER AE:

1. The user selects a Modality Worklist entry on the Worklist Browser.
2. User enters the 'Acquire Mode' by clicking on the 'Start Exam' and selecting the desired protocols.

3. If the PPS Server is configured on the system and is active, a PPS NCREATE is issued on 'Start Exam'.
4. The MPPS Final N-SET for 'Complete'/'Discontinued' shall be issued on Close Exam.
5. The MPPS N-SET for Completed or Discontinued includes the complete list of images created and the Radiation Dose information.

## 2.3 AE SPECIFICATIONS

### 2.3.1 DICOM Server AE Specification

This Application Entity provides Standard Conformance to the following DICOM SOP Classes as a SCU:

SOP Class Name	SOP Class UID
Digital X-ray Image Storage - For Presentation	1.2.840.10008.5.1.4.1.1.1.1
Digital X-ray Image Storage - For Processing	1.2.840.10008.5.1.4.1.1.1.1.1
Computed Radiography Image Storage	1.2.840.10008.5.1.4.1.1.1
Secondary Capture Image Storage	1.2.840.10008.5.1.4.1.1.7
Study Root Query/Retrieve Information Model - FIND	1.2.840.10008.5.1.4.1.2.2.1
Study Root Query/Retrieve Information Model - MOVE	1.2.840.10008.5.1.4.1.2.2.2
Verification SOP Class	1.2.840.10008.1.1
Storage Commitment Push Model	1.2.840.10008.1.20.1

**Note:** C-FIND is done using Study Root Information Model.

**Note:** C-MOVE is done using Study Root Information Model.

**Note:** Please also refer to sections 6 for Network Print Management SCU Conformance Statement.

This Application Entity provides Standard Conformance to the following DICOM SOP Classes as a SCP:

SOP Class Name	SOP Class UID
Digital X-ray Image Storage – For Presentation	1.2.840.10008.5.1.4.1.1.1.1
Digital X-ray Image Storage – For Processing	1.2.840.10008.5.1.4.1.1.1.1.1
Secondary Capture Image Storage	1.2.840.10008.5.1.4.1.1.7
Verification SOP Class	1.2.840.10008.1.1

**Note:** Only Secondary Captures whose Modality is DX are supported.

#### 2.3.1.1 Association Establishment Policies

##### 1. General

The DICOM Application Context Name (ACN), which is always proposed, is:

Application Context Name	1.2.840.10008.3.1.1.1
--------------------------	-----------------------

The Maximum Length PDU negotiation is included in all association establishment requests.

The maximum length PDU for an association initiated by the DICOM SERVER AE is:

Maximum Length PDU	28Kbytes
--------------------	----------



The SOP Class Extended Negotiation is not supported.

The maximum number of Presentation Context Items that will be proposed is 18.

The user information Items sent by this product are:

- Maximum PDU Length
- Implementation UID

2. Number of Associations

The DICOM SERVER AE will initiate up to two DICOM associations at a time to perform a DICOM store operation as a SCU to a Remote Host AE.

The DICOM SERVER AE can have any number of open DICOM associations at a time to perform a DICOM store operation as a SCP or respond to an echo.

The DICOM SERVER AE will initiate up to 3 DICOM associations at a time to perform a Query/Retrieve with a Remote Host AE.

3. Asynchronous Nature

Asynchronous mode is not supported. All operations will be performed synchronously.

4. Implementation Identifying Information

The Implementation UID for this DICOM Implementation is:

**Table 2-1 : Discovery XR656 GII**

Discovery XR656 Acquisition Workstation Implementation UID	1.2.840.113619.6.369
Discovery XR656 Acquisition Workstation Implementation Version Name	Discovery XR656

**Table 2-2 : Optima XR646**

Optima XR646 Acquisition Workstation Implementation UID	1.2.840.113619.6.370
Optima XR646 Acquisition Workstation Implementation Version Name	Optima XR646

**Table 2-3 : Definium 6000 (V)**

Definium 6000 Acquisition Workstation Implementation UID	1.2.840.113619.6.370
Definium 6000 Acquisition Workstation Implementation Version Name	Optima XR646

**Table 2-4 : Discovery XR656**

Discovery XR656 Acquisition Workstation Implementation UID	1.2.840.113619.6.203
Discovery XR656 Acquisition Workstation Implementation Version Name	Global 1 Platform

5. Association Initiation by Real-World Activity

5.1 Real-World Activity: Manual Transfer of Patients/Studies/Series/Images

5.1.1 Associated Real-World Activity

The operator does the following:

- Select in the BROWSER one or several Patient Folders (or Studies/Series/Images) to be sent. Then click on the Remote DICOM AE displayed as an icon among the configured destination nodes.

This operation will cause:

- The Acquisition Workstation to retrieve the selected images from its local database.
- The DICOM SERVER AE to initiate a DICOM association, negotiate with the Remote AE an appropriate Abstract and Transfer Syntax.
- To emit C-STORE command to send the images, if the negotiation is successful.

5.1.2 Proposed Presentation Context Table

Presentation Context Table - Proposed

Abstract Syntax		Transfer Syntax		Role	Extended Negotiation
Name	UID	Name List	UID List		
Digital X-ray Image Storage - For Presentation	1.2.840.10008.5.1.4.1.1.1.1	Explicit VR Big Endian	1.2.840.10008.1.2.2	SCU	None
Digital X-ray Image Storage - For Presentation	1.2.840.10008.5.1.4.1.1.1.1	Implicit VR Little Endian	1.2.840.10008.1.2	SCU	None
Digital X-ray Image Storage - For Presentation	1.2.840.10008.5.1.4.1.1.1.1	Explicit VR Little Endian	1.2.840.10008.1.2.1	SCU	None
Digital X-ray Image Storage - For Processing	1.2.840.10008.5.1.4.1.1.1.1.1	Explicit VR Big Endian	1.2.840.10008.1.2.2	SCU	None
Digital X-ray Image Storage - For Processing	1.2.840.10008.5.1.4.1.1.1.1.1	Implicit VR Little Endian	1.2.840.10008.1.2	SCU	None
Digital X-ray Image Storage - For Processing	1.2.840.10008.5.1.4.1.1.1.1.1	Explicit VR Little Endian	1.2.840.10008.1.2.1	SCU	None
Secondary Capture Image Storage	1.2.840.10008.5.1.4.1.1.7	Explicit VR Big Endian	1.2.840.10008.1.2.2	SCU	None
Secondary Capture Image Storage	1.2.840.10008.5.1.4.1.1.7	Implicit VR Little Endian	1.2.840.10008.1.2	SCU	None
Secondary Capture Image Storage	1.2.840.10008.5.1.4.1.1.7	Explicit VR Little Endian	1.2.840.10008.1.2.1	SCU	None
Computed Radiography Image Storage	1.2.840.10008.5.1.4.1.1.1	Explicit VR Big Endian	1.2.840.10008.1.2.2	SCU	None
Computed Radiography Image Storage	1.2.840.10008.5.1.4.1.1.1	Implicit VR Little Endian	1.2.840.10008.1.2	SCU	None
Computed Radiography Image Storage	1.2.840.10008.5.1.4.1.1.1	Explicit VR Little Endian	1.2.840.10008.1.2.1	SCU	None

5.1.2.1 Common SOP Specific DICOM Conformance Statement for all Storage SOP Classes

Following are the status codes that are more specifically processed when receiving messages from a Storage SCP equipment:

Service Status	Status Codes	Further Meaning	Application Behavior When Receiving Status Codes	Related Fields Processed if received
Refused	A7xx	Out of resources	Association is closed with Remote AE. A message is displayed to the user. Error is logged.	(0000,0902)
	0122	SOP Class not Supported	Association is closed with Remote AE. A message is displayed to the user. Error is logged.	(0000,0902)
Error	Cxxx	Cannot Understand	Association is closed with Remote AE. A message is displayed to the user. Error is logged.	(0000,0901) (0000,0902)
	A9xx	Data Set does not match SOP Class	Association is closed with Remote AE. A message is displayed to the user. Error is logged.	(0000,0901) (0000,0902)
Warning	B000	Coercion of Data Elements	Association is closed with Remote AE. A message is displayed to the user. Error is logged.	(0000,0901) (0000,0902)
	B007	Data Set does not match SOP Class	Association is closed with Remote AE. A message is displayed to the user. Error is logged.	(0000,0901) (0000,0902)
	B006	Elements Discarded	Association is closed with Remote AE. A message is displayed to the user. Error is logged.	(0000,0901) (0000,0902)
Success	0000			None

SOP Specific DICOM Conformance Statement for Digital X-ray Storage SOP Classes

As described earlier, when the operator selects one or several images to be sent to a remote host, the DICOM SERVER AE initiates a DICOM association and negotiates with the Remote AE an appropriate Abstract and Transfer Syntax. If the images to be sent are Digital X-ray For Processing Image, the Remote AE has to accept one of the following proposed presentation context:

Presentation Context Table - Proposed

Name	Abstract Syntax		Transfer Syntax		Role	Extended Negotiation
	UID	UID	Name List	UID List		
Digital X-ray Image Storage - For Processing	1.2.840.10008.5.1.4.1.1.1.1.1		Explicit VR Big Endian	1.2.840.10008.1.2.2	SCU	None
Digital X-ray Image Storage - For Processing	1.2.840.10008.5.1.4.1.1.1.1.1		Implicit VR Little Endian	1.2.840.10008.1.2	SCU	None
Digital X-ray Image Storage - For Processing	1.2.840.10008.5.1.4.1.1.1.1.1		Explicit VR Little Endian	1.2.840.10008.1.2.1	SCU	None

If the images to be sent are Digital X-ray For Presentation Image, the Remote AE has to accept one of the following proposed presentation context:

Presentation Context Table - Proposed

Abstract Syntax		Transfer Syntax		Role	Extended Negotiation
Name	UID	Name List	UID List		
Digital X-ray Image Storage - For Presentation	1.2.840.10008.5.1.4.1.1.1.1	Explicit VR Big Endian	1.2.840.10008.1.2.2	SCU	None
Digital X-ray Image Storage - For Presentation	1.2.840.10008.5.1.4.1.1.1.1	Implicit VR Little Endian	1.2.840.10008.1.2	SCU	None
Digital X-ray Image Storage - For Presentation	1.2.840.10008.5.1.4.1.1.1.1	Explicit VR Little Endian	1.2.840.10008.1.2.1	SCU	None

If the Remote AE does not accept any of the above Proposed Presentation Context according to the image type, but accepts one of the Presentation Context of the table below, then the image of type Digital X-ray (DX) For Processing or For Presentation will be fallback into an image of type Computed Radiography (CR) before being sent to the Remote AE.

Presentation Context Table - Proposed

Abstract Syntax		Transfer Syntax		Role	Extended Negotiation
Name	UID	Name List	UID List		
Computed Radiography Image Storage	1.2.840.10008.5.1.4.1.1.1	Explicit VR Big Endian	1.2.840.10008.1.2.2	SCU	None
Computed Radiography Image Storage	1.2.840.10008.5.1.4.1.1.1	Implicit VR Little Endian	1.2.840.10008.1.2	SCU	None
Computed Radiography Image Storage	1.2.840.10008.5.1.4.1.1.1	Explicit VR Little Endian	1.2.840.10008.1.2.1	SCU	None

The produced image after fallback from DX to CR, will contain the attributes defined in the DICOM Standard for CR SOP and all attributes that can be found in the original image as the extended IOD for CR is supported.

The modules that are specific to a CR image (CR Series and CR Image module) will be filled and some of the modules that are common to both IODs (Patient, General Study, General Series, General Image, SOP Common,...) will be modified. Every field added or modified is detailed:

CR Series Module:

Attribute Name	Tag	Type	Attribute Description	Conversion Rule
Body Part Examined	(0018,0015)	2	Text Description of the part of the body examined	If it is not present in the original image, it will be added and set to zero length value. If it is present in original image, it will keep the same value.
Filter Type	(0018,1160)	3	Label of the type of filter inserted into the X-ray beam	Same value as in the original image (may be zero length or absent)
Collimator/grid Name	(0018,1180)	3	Label describing any grid inserted	Not sent (Never present in original image)

Focal Spot	(0018, 1190)	3	Size of the focal spot in mm. For devices with variable focal spot or multiple focal spots, small dimension followed by large dimension.	Same value as in the original image (may be zero length or absent)
Plate Type	(0018,1260)	3	Label of the type of storage phosphor plates used in this series	Not sent. (Never present in original image)
Phosphor Type	(0018,1261)	3	Label of type of phosphor on the plates	Not Sent. (Never present in original image)
View Position	(0018,5101)	2	Radiographic view associated with Patient Position (0018,5100)	If it is not present in the original image, it will be added and set to zero length value. If it is present in original image, it will keep the same value.

**CR Image Module:**

Attribute Name	Tag	Type	Attribute Description	Conversion Rule
KVP	(0018,0060)	3	Peak kilo voltage output of the X-ray generator used	Same value as in the original image (may be zero length or absent)
Plate ID	(0018,1004)	3	The ID or serial number of the sensing plate upon which the image was acquired.	Not Sent. (Never present in original image)
Distance Source to Detector	(0018,1110)	3	Distance in mm from source to detector center.	Same value as in the original image (may be zero length or absent)
Distance Source to Patient	(0018,1111)	3	Distance in mm from source to tabletop.	Same value as in the original image (may be zero length or absent)
Exposure Time	(0018,1150)	3	Time of X-ray exposure in mSec	Same value as in the original image (may be zero length or absent)
X-ray Tube Current	(0018,1151)	3	X-ray tube current in mA	Same value as in the original image (may be zero length or absent)
Exposure	(0018,1152)	3	The product of exposure time and Xray tube current expressed in mAs	Same value as in the original image (may be zero length or absent)
Exposure in mAs	(0018,1153)	3	The product of exposure time and Xray tube current expresses in mAs	
Imager Pixel Spacing	(0018,1164)	3	Physical distance measured at the tabletop between the center of each projected image pixel, specified by Row dimension and Column dimension.	This value does not always equal Detector Element Spacing. Imager Pixel Spacing = Detector Element Spacing * (Distance Source to Tabletop / Distance Source to Detector)
Generator Power	(0018,1170)	3	Power in kW to the X-ray generator	Not Sent. (Never present in original image)
Acquisition Device Processing Description	(0018,1400)	3	Describe device-specific processing associated with the image	Same value as in the original image (may be zero length or absent)

Acquisition Device Processing Code	(0018,1401)	3	Code representing the device-specific processing associated with the image.	Same value as in the original image (may be zero length or absent)
Cassette Orientation	(0018,1402)	3	Orientation of Cassette..	Not Sent. (Never present in original image)
Cassette Size	(0018,1403)	3	Size of Cassette.	Not Sent. (Never present in original image)
Exposures on Plate	(0018,1404)	3	Total Number of X-ray exposures that have been made on the plate identified in Plate ID (0018,1004)	Not Sent. (Never present in original image)
Relative X-ray Exposure	(0018,1405)	3	Relative X-ray exposure on the plate. Meaning of values is implementation specific.	Same value as in the original image (may be zero length or absent)
Sensitivity	(0018,6000)	3	Read out sensitivity	Same value as in the original image (may be zero length or absent)

General Study Module:

The attributes of the General Study Module - including the Study Instance UID (0020,000D) and the Study ID (0020,0010) - will be equal to those in the original image.

General Series Module:

The attributes of the General Series Module will be equal to those in the original image, except:

Modality (0008,0060): Set to CR.

Series Instance UID (0020,000E): As a DICOM series can only contain objects with the same modality, a new UID should be created.

Laterality (0020, 0060): Set according to the value found in Image Laterality (0020,0062) of the original image.

L in Image Laterality (0020,0062) => L in Laterality (0020, 0060)

R in Image Laterality (0020,0062) => R in Laterality (0020, 0060)

U or B in Image Laterality (0020,0062) => Laterality (0020,0060) is absent

General Equipment Module:

The attributes of the General Equipment module will be equal to those in the original image.

General Image Module:

The attributes of the General Image Module will be equal to those in the original image except:

Image Type (0008,0008): The two first values of this multi-values attribute will always be ORIGINAL (pixel values are based on original data) and SECONDARY (image created after the initial patient examination). The third and later values are provided if present in the original image.

Derivation Description (0008,2111): this attribute will be created and will contain "CR Fallback"

Ref Image Sequence (0008,2112): This sequence will be in the General Image Module. It will be composed of one item containing the SOP Class and SOP Instance UIDs of the original image.

Image Pixel Module:

The attributes of the Image Pixel Module will be equal to those in the original image.

SOP Common Module:

Attribute Name	Tag	Type	Attribute Description	Conversion Rule
Specific Character Set	(0008,0005)	1	Character Set that expands or replace the Basic Graphic Set.	Same value as in the original image (ISOIR_100)
Instance Creation Date	(0008,0012)	3	Date the SOP Instance was created	Not Sent. (Never present in original image)
Instance Creation Time	(0008,0013)	3	Time the SOP Instance was created	Not Sent. (Never present in original image)
Instance Creator UID	(0008,0014)	3	Uniquely identifies the device which created the SOP Instance	Not Sent. (Never present in original image)
SOP Class UID	(0008,0016)	1	Uniquely identified the SOP Class	Set to 1.2.840.10008.5.1.4.1.1.1
SOP Instance UID	(0008, 0018)	1	Uniquely identified the SOP Instance	New UID is generated

5.2 Real-World Activity: Automatic Transfer of Patients/Studies/Series/Images

5.2.1 Associated Real-World Activity

The operator does the following:

- Set Auto-Push ON, select Auto-Push remote hosts, and set the default setting for Quality Check (“OK to send” or “Not OK to send”).
- Start an exam and acquire images and close the exam.
- Set the Quality Check flag as desired for each image. Configurable feature with two choices; QC defaulted to OK, QC defaulted to NOT OK.
- Close the exam.

This operation will cause:

- The DICOM SERVER AE to initiate a DICOM association, negotiate with the Remote AE an appropriate Abstract and Transfer Syntax.
- To emit C-STORE command to send the “OK to send” images, if the negotiation is successful.

5.2.2 Proposed Presentation Context Table

Same as Real World Activity “Manual Transfer of Patients / Studies / Series / Images”.

5.2.2.1 Common SOP Specific DICOM Conformance Statement for all Storage SOP Classes

Same as Real World Activity “Manual Transfer of Patients / Studies / Series / Images”.

5.2.2.2 SOP Specific DICOM Conformance Statement for Digital X-ray Storage SOP Classes

Same as Real World Activity “Manual Transfer of Patients / Studies / Series / Images”.

5.3.Real-World Activity: Manual Query/Retrieve

5.3.1Associated Real-World Activity

The operator queries a Remote database by clicking on the icon representing the DICOM Remote AE. A new BROWSER (known as the REMOTE BROWSER) appears on the screen(s) upon successful query.

Then, the operator can select one or several Patient Folders / Studies / Series / Images and can either drag and drop the selection on the icon representing the Acquisition Workstation or click on the “Pull” icon to retrieve the selection into the Acquisition Workstation database.

This operation will cause:

- the DICOM SERVER AE to initiate a DICOM association.
- the DICOM SERVER AE to emit a C-FIND request to get a list of patients regarding the criteria listed below, then to get the selected studies, series or images.
- the DICOM SERVER AE to emit a C-MOVE request to specify a selected list of Patient Folders/ Studies/Series/Images to be sent by the Remote Host to the Acquisition Workstation.

5.3.2 Proposed Presentation Context Table

Presentation Context Table - Proposed

Abstract Syntax		Transfer Syntax		Role	Extended Negotiation
Name	UID	Name List	UID List		
Study Root Query/Retrieve Information Model - FIND	1.2.840.10008.5.1.4.1.2.2.1	Implicit VR Little Endian	1.2.840.10008.1.2	SCU	None
Study Root Query/Retrieve Information Model - MOVE	1.2.840.10008.5.1.4.1.2.2.2	Implicit VR Little Endian	1.2.840.10008.1.2	SCU	None

SOP Specific DICOM Conformance Statement for the Model, Study Root Query/Retrieve Information Model -FIND SOP Class

Following are the status codes that are more specifically processed when receiving messages from a Query SCP equipment:

Service Status	Status Codes	Further Meaning	Application Behavior When Receiving Status Codes	Related Fields Processed if received
Refused	A7xx	Out of resources	Association is closed. Appropriate message is displayed to the user.	(0000,0902)
	0122	SOP Class not Supported	Association is closed. Appropriate message is displayed to the user.	(0000,0902)
Failed	A9xx	Identifier does not match SOP Class	Association is closed. Error message is displayed to the user.	(0000,0901) (0000,0902)
	Cxxx	Unable to process	Association is closed. Error message is displayed to the user.	(0000,0901) (0000,0902)
Cancel	FE00	Matching terminated due to cancel	Association is closed. Error message is displayed to the user.	None
Success	0000	Matching is complete - No final identifier is supplied		None



Pending	FF00	Matches are continuing - Current Match is supplied and any Optional Keys were supported in the same manner as Required Keys.		Identifier
	FF01	Matches are continuing - Warning that one or more Optional Keys were not supported for existence and/or matching for this Identifier		Identifier

**Note:** Status code Cancel is considered as an error because it should never be received, as the user can't ask for a cancel.

The C-FIND SCU will only perform hierarchical query (No extended negotiation supported)

Each C-FIND SCU supports an "Association Timer" which is defaulted to 15 seconds.

The DICOM SERVER AE will parse each matching C-FIND-RSP reply and will close the association if an entry does not contain a valid data set.

6. Association Acceptance Policy

When the DICOM SERVER AE accepts an association, it will receive any images transmitted on that association and store the supported SOP Classes on disk. Any Remote DICOM AE can send images to the DICOM SERVER AE.

6.1 Real-World Activity "Image Installation"

The DICOM SERVER AE accepts an association when it receives a valid association request from a DICOM Storage SCU.

6.1.1 Associated Real-World Activity

The DICOM SERVER AE waits for any association. No operator action is required to receive an image.

6.1.2 Accepted Presentation Context Table

Presentation Context Table - Proposed

Abstract Syntax		Transfer Syntax		Role	Extended Negotiation
Name	UID	Name List	UID List		
Digital X-ray Image Storage - For Presentation	1.2.840.10008.5.1.4.1.1.1.1	Implicit VR Little Endian	1.2.840.10008.1.2	SCU	None
Digital X-ray Image Storage - For Processing	1.2.840.10008.5.1.4.1.1.1.1.1	Implicit VR Little Endian	1.2.840.10008.1.2	SCU	None
Secondary Capture Image Storage	1.2.840.10008.5.1.4.1.1.7	Implicit VR Little Endian	1.2.840.10008.1.2	SCU	None

Verification SOP Class	1.2.840.10008.1.1	Implicit VR Little Endian	1.2.840.10008.1.2	SCU	None
------------------------	-------------------	---------------------------	-------------------	-----	------

6.1.2.1 SOP Specific DICOM Conformance Statement for all Storage SOP Classes

Following are the status codes the Application may send back to the SCU Equipment after performing the requested Storage:

Service Status	Status Codes	Further Meaning	Application Behavior When Receiving Status Codes	Related Fields Processed if received
Refused	A7xx	Out of resources	Indicates that there was not enough space or some other internal resource (such as memory) to store the image. The user should attempt recovery by removing some images from the Acquisition Workstation	(0000,0902)
Error	0110	Processing Failure	Indicates that an internal system call has failed while processing the image.	(0000,0902)
Success	0000			None

Each C-STORE SCP supports an “Association Timer” which is defaulted to 15 seconds.

The DICOM Server AE conforms to the SOP’s of the Storage Service Class at Level 2 (Full) as described in Section B4.1 of PS 3.4 of the DICOM Standard Document.

Image Reception phase:

- If the DICOM Server AE fails to parse the received image, the error 110 (Processing Failure) is returned to the C-STORE SCU.
- If the DICOM Server AE fails to install the received image into the local database, the error A700 (Out of Resources) is returned to the C-STORE SCU.

When a C-STORE operation is returned Successful to the C-STORE SCU, the image has been written to the disk and declared into the local database. The image will then be accessed in the same manner as any other image by the applications on the Acquisition Workstation.

When a C-STORE operation is returned Error to the C-STORE SCU, the image will be removed and a message will appear in the browser message log informing the user of a failure.

6.1.3 Presentation Context Acceptance Criterion

Only known SOP Classes are accepted.

6.1.4 Transfer Syntax Selection Policies

The default transfer syntax for SOP Classes is always Implicit VR Little Endian: (1.2.840.10008.1.2).

2.3.2 Worklist Server AE Specification

This Application Entity provides Standard Conformance to the following DICOM V3.0 SOP Classes as an SCU:

SOP Class Name	SOP Class UID
Modality Worklist Information Model – FIND	1.2.840.10008.5.1.4.31

**2.3.2.1 Association Establishment Policies**

1. General

The DICOM Application Context Name (ACN), which is always proposed, is:

<b>Application Context Name</b>	1.2.840.10008.3.1.1.1
---------------------------------	-----------------------

The Maximum Length PDU negotiation is included in all association establishment requests. The maximum length PDU for an association initiated by the WORKLIST SERVER AE is:

<b>Maximum Length PDU</b>	28Kbytes
---------------------------	----------

The SOP Class Extended Negotiation is not supported.

The maximum number of Presentation Context Items that will be proposed is 1.

The user information Items sent by this product are:

- Maximum PDU Length
- Implementation UID

2. Number of Associations

The WORKLIST SERVER AE (SCU) will initiate only one DICOM association at a time to perform a modality worklist query of a single remote AE.

3. Asynchronous Nature

Asynchronous mode is not supported. All operations will be performed synchronously.

4. Implementation Identifying Information

The Implementation UID for this DICOM Implementation is:

**Table 2-5 : Discovery XR656 GII**

<b>Discovery XR656 Acquisition Workstation Implementation UID</b>	1.2.840.113619.6.369
<b>Discovery XR656 Acquisition Workstation Implementation Version Name</b>	Discovery XR656

**Table 2-6 : Optima XR646**

<b>Optima XR646 Acquisition Workstation Implementation UID</b>	1.2.840.113619.6.370
<b>Optima XR646 Acquisition Workstation Implementation Version Name</b>	Optima XR646

**Table 2-7 : Definium 6000 (V)**

<b>Definium 6000 Acquisition Workstation Implementation UID</b>	1.2.840.113619.6.370
<b>Definium 6000 Acquisition Workstation Implementation Version Name</b>	Optima XR646

**Table 2-8 : Discovery XR656**

<b>Discovery XR656 Acquisition Workstation Implementation UID</b>	1.2.840.113619.6.203
<b>Discovery XR656 Acquisition Workstation Implementation Version Name</b>	Global 1 Platform

5. Association Initiation by Real-World Activity

5.1 Real-World Activity: Worklist Query

5.1.1 Associated Real-World Activity

The operator of the system initiates a query for a modality worklist by pressing the REFRESH WORKLIST button of the Worklist screen. The Worklist Server will then initiate an association with the remote AE in order to query for the worklist

A user can configure a number of parameters that directly control the worklist query request. The user can request worklist items that are intended for the system the user is working at, all items that apply to the modality of the system the user is working at or all worklist items available. These selections and their affects on worklist query parameters are given below:

This System:

- Modality, (0008,0060) - set to DX
- Scheduled Station AE Title, (0040,0001) - set to Query AE title

This Modality:

- Modality, (0008,0060) - set to DX
- Scheduled Station AE Title, (0040,0001) - zero-length (universal matching)

All Systems:

- Modality, (0008,0060) - zero-length (universal matching)
- Scheduled Station AE Title, (0040,0001) - zero-length (universal matching)

The scheduled dates of procedures of interest can be specified for query by selecting a specific date range. The date ranges available are Today, Tomorrow or between two given dates. These selections and their affects on worklist query parameters are given below:

Today:

Scheduled Procedure Step Start Date, (0040,0002) - set to YYYYMMDDYYYYMMDD, where YYYYMMDD is the current date.

Tomorrow:

Scheduled Procedure Step Start Date, (0040,0002) - set to YYYYMMDDYYYYMMDD, where YYYYMMDD is tomorrow date.

Between 2 dates:

Scheduled Procedure Step Start Date, (0040,0002) - set to YYYYMMDDYYYYMMDD', where YYYYMMDD is set to given From date and YYYYMMDD' is set to given To date.

Patient Name:

Patient Name, (0010,0010) - set to given Patient Name

Patient ID:

Patient ID, (0010,0020) - set to given Patient ID

5.1.2 Proposed Presentation Context Table

The following table shows the proposed presentation contexts for the Worklist Server AE after real-world activity “Worklist Query” has been initiated:

Presentation Context Table - Proposed

Abstract Syntax		Transfer Syntax		Role	Extended Negotiation
Name	UID	Name List	UID List		
Modality Worklist Information Model - FIND	1.2.840.10008.5.1.4.31	Implicit VR Little Endian	1.2.840.10008.1.2	SCU	None

5.1.2.1 SOP Specific DICOM Conformance Statement for the Worklist SOP Class

Following are the status codes that are more specifically processed when receiving messages from a Modality Worklist SCP:

If the remote AE does not support the proposed Presentation Context, an appropriate error is logged and the operator is notified.

This implementation can receive multiple C-FIND results over a single association. Only one association is opened at a time.

Each C-FIND response received from the remote AE is parsed to verify the length/type of the items in the response. Upon detecting any error in the response data, the Worklist Server AE will ignore the bad data and carry on to the next C-FIND response.

On receipt of any error from the remote AE, the Worklist Server will issue a CFIND- CANCEL and, upon receipt of a C-FIND-RSP (or if an applicable timer expires), will close the association.

Warnings received from the remote AE are ignored.

Each C-FIND operation supports an “Association Timer.” This timer starts when the association request is sent or received and stops when the association is established. The default time-out value is 15 seconds.

If the above timer expires, the association is aborted (A-ABORT) and the operation in progress is considered to have failed. Any previously received worklist items are kept.

5.2.1.2 Record Acceptance Policy

All worklist items coming from the remote AE are accepted. Nevertheless, the system filters each received worklist item checking that it matches the query parameters. If the received worklist item matches the query parameter, then it is stored in the local Worklist database and displayed to the user, else it is ignored.

The filter checks the following fields:

Tag Value	Worklist Attribute	Acceptance
0008,0005	Specific Character Set	Check that value is empty or equal to ISO_IR 100
0008,0060	Modality	Check that value is empty or equal to DX
0010,0010	Patient Name	If value defined in Query Definition Window, check that value matches the defined value
0010,0020	Patient ID	If value defined in Query Definition Window, check that value matches the defined value
0040,0001	Scheduled Station AE Title	If matching is defined in the query parameters, then check that value is empty or equal to the defined value in query parameters setting.
0040,0002	Scheduled Procedure Step Start Date	If matching is defined in the query parameters, then check that value is empty or equal to the defined value in query parameters setting.

### 2.3.2.2 Association Acceptance Policy

The Worklist Server AE does not respond to attempts by a remote AE to open an association.

### 2.3.3 Storage Commitment Server AE Specification

This Application Entity provides Standard Conformance to the following DICOM SOP Classes as an SCU:

SOP Class Name	SOP Class UID
Storage Commitment Push Model	1.2.840.10008.1.20.1

#### 2.3.3.1 Association Establishment Policies

##### 1. General

The DICOM Application Context Name (ACN), which is always proposed, is:

Application Context Name	1.2.840.10008.3.1.1.1
--------------------------	-----------------------

The Maximum Length PDU negotiation is included in all association establishment requests. The maximum length PDU for an association initiated by the STORAGE COMMITMENT SERVER AE is:

Maximum Length PDU	28Kbytes
--------------------	----------

The SOP Class Extended Negotiation is not supported.

The maximum number of Presentation Context Items that will be proposed is 1.

The user information Items sent by this product are:

- Maximum PDU Length
- Implementation UID

##### 2. Number of Associations

The STORAGE COMMITMENT SERVER AE will initiate only one DICOM association at a time to perform a DICOM storage commitment operation as a SCU to a Remote Host AE.

##### 3. Asynchronous Nature

Asynchronous mode is not supported. All operations will be performed synchronously.

##### 4. Implementation Identifying Information

The Implementation UID for this DICOM Implementation is:

**Table 2-9 : Discovery XR656 GII**

Discovery XR656 Acquisition Workstation Implementation UID	1.2.840.113619.6.369
Discovery XR656 Acquisition Workstation Implementation Version Name	Discovery XR656

**Table 2-10 : Optima XR646**

Optima XR646 Acquisition Workstation Implementation UID	1.2.840.113619.6.370
Optima XR646 Acquisition Workstation Implementation Version Name	Optima XR646

**Table 2-11 : Definium 6000 (V)**

Definium 6000 Acquisition Workstation Implementation UID	1.2.840.113619.6.370
Definium 6000 Acquisition Workstation Implementation Version Name	Optima XR646

**Table 2-12 : Discovery XR656**

Discovery XR656 Acquisition Workstation Implementation UID	1.2.840.113619.6.203
Discovery XR656 Acquisition Workstation Implementation Version Name	Global 1 Platform

5. Association Initiation by Real-World Activity

5.1 Real-World Activity: Images successfully sent to a remote host declared as a Storage Commitment Provider

5.1.1 Associated Real-World Activity

The user can configure a Remote Host as a Storage Commitment Provider on the Acquisition Workstation.

The operator selects in the BROWSER one or several Patient Folders (or Studies/Series/ Images) to be sent. Then, the user can click on the icon representing the Remote DICOM AE. The selected Remote DICOM AE must be declared as a Storage Commitment Provider.

This operation will cause:

- The Acquisition Workstation to retrieve the selected image from its local database.
- The DICOM SERVER AE to initiate a DICOM association, negotiate with the Remote AE an appropriate Abstract and Transfer Syntax.
- To emit C-STORE command to send the image, if the negotiation is successful.
- When all images have been successfully sent, the DICOM SERVER AE asks the STORAGE COMMITMENT SERVER AE to commit the images.
- The STORAGE COMMITMENT SERVER AE initiates a DICOM association, negotiate with the Remote AE an appropriate Abstract and Transfer Syntax.
- If the negotiation is successful, STORAGE COMMITMENT SERVER AE emits a N-ACTION request. Only one N-ACTION Request is sent for all images to be committed.

Note: Storage Commitment is never requested for images sent to remote host with CR Fallback (see section 2.3.1.1.5.1.2.2)

5.1.2 Proposed Presentation Context Table

**Presentation Context Table - Proposed**

Abstract Syntax		Transfer Syntax		Role	Extended Negotiation
Name	UID	Name List	UID List		
Storage Commitment Push Model	1.2.840.10008.1.20.1	Explicit VR Big Endian	1.2.840.10008.1.2.2	SCU	None

Storage Commitment Push Model	1.2.840.10008.1.20.1	Implicit VR Little Endian	1.2.840.10008.1.2	SCU	None
Storage Commitment Push Model	1.2.840.10008.1.20.1	Implicit VR Little Endian	1.2.840.10008.1.2.1	SCU	None

5.1.2.1 SOP Specific DICOM Conformance Statement for the Storage Commitment Push Model SOP Class

If the association negotiation is not successful the STORAGE COMMITMENT SERVER AE retries the association negotiation, and if association negotiation still fails, an error file is logged and the Storage Commitment is abandoned.

After the N-ACTION request, if the received N-ACTION Response from the Storage Commitment Provider has a failure status, an error file is logged, the Storage Commitment is abandoned and a pop-up is displayed to the user.

After the N-ACTION request, if the received N-ACTION Response from the Storage Commitment Provider has a success status, the STORAGE COMMITMENT SERVER AE can receive the N-EVENT-REPORT from the Storage Commitment Provider at any time (See section Real-World Activity "Image Remotely Committed") There is no time out to limit the period of time between the reception of the N-ACTION Response and the reception of the N-EVENT-REPORT from the Storage Commitment Provider.

6. Association Acceptance Policy

The STORAGE COMMITMENT SERVER AE accepts an association for Storage Commitment notification (N-EVENT-REPORT) only as a SCU. The Storage Commitment Provider initiating the association must use the role selection negotiation.

6.1.1 Real-World Activity "Image Remotely Committed"

The STORAGE COMMITMENT SERVER AE accepts an association when it receives a valid association request from a STORAGE COMMITMENT Provider.

6.1.2 Accepted Presentation Context Table

Presentation Context Table - Proposed

Abstract Syntax		Transfer Syntax		Role	Extended Negotiation
Name	UID	Name List	UID List		
Storage Commitment Push Model	1.2.840.10008.1.20.1	Explicit VR Big Endian	1.2.840.10008.1.2.2	SCU	None
Storage Commitment Push Model	1.2.840.10008.1.20.1	Implicit VR Little Endian	1.2.840.10008.1.2	SCU	None
Storage Commitment Push Model	1.2.840.10008.1.20.1	Implicit VR Little Endian	1.2.840.10008.1.2.1	SCU	None

Note: The Storage Commitment Provider initiating the association must use the role selection negotiation.

6.1.2.1 SOP Specific DICOM Conformance Statement for all Storage SOP Classes

Following are the status codes the Application may send back to the SCP Equipment after receiving the N-EVENT-REPORT:

Service Status	Status Codes	Further Meaning	Status Code sending explanation	Related Fields sent back to the SCP
Error	0110	Processing Failure	Indicates that an internal system call has failed while processing the storage commitment notification	None
Success	0000			None



Storage Commitment Notification notifies the STORAGE COMMITMENT SERVER AE if the Storage Commitment Provider has successfully committed the images or not.

If an image has been successfully committed, the STORAGE COMMITMENT SERVER AE asks the local database to flag the image as "Committed".

If an image has NOT been committed, the STORAGE COMMITMENT SERVER AE logs the error file and displays a pop-up to the user.

If the STORAGE COMMITMENT SERVER AE has successfully processed the notification as described above, Success is sent back to the Storage Commitment Provider else Error.

#### 6.1.3 Presentation Context Acceptance Criterion

The Storage Commitment Provider initiating the association must use the role selection negotiation.

#### 6.1.4 Transfer Syntax Selection Policies

Explicit Little Endian transfer syntax is chosen first, then the Implicit Little Endian and then the Explicit Big Endian.

### 2.3.4 PPS Server AE Specification

#### 2.3.4.1 Performed Procedure Step

##### 1. Associated Real-World Activity

The real-world activities are mentioned in section 2.2.3 Sequencing of Real- World Activities. Each of the real world activity results in either creating a new Performed Procedure Step SOP instance at the remote SCP or updating an already created Performed Procedure SOP instance as per the DICOM standard.

##### 2. N-CREATE & N-SET REQUEST MESSAGE

PPS Feature for this product supports all named attributes listed in Table F.7.2.1 in PS3.4 of DICOM Standard. This feature also supports the attributes listed in the optional Radiation Dose Module. The attributes referenced in the Billing and Material Code Module are not supported.

This product supports the selection of single or multiple SPS for a scan. The following are applicable:

Single SPS selection results in single PPS message

Multiple SPS (n) selection results in Multiple PPS (n), where n is the number of SPSs selected.

Multiple SPS selection is allowed only if they all correspond to same Patient Name, Patient ID, DOB, and SPS Date.

At the end of Acquisition, the user might choose to 'Defer PPS' by selection of SUSPEND exam option and later choose to 'Complete PPS' or 'Discontinue PPS' from the User interface provided on the system. In this case, the date and time when user chooses to 'Complete PPS' or 'Discontinue PPS' is taken as the Performed Procedure Step End Date and Performed Procedure End Time respectively. (Not the actual end date and end time of acquisition) Mapping of SPS data to MPPS SOP instance is explained in section 10-1.

Mapping of Specific SPS data to DX DICOM Image Header, for PPS is explained in Section 10-1.

#### ERROR HANDLING & RECOVERY

PPS Server AE does not define any extended error codes. The Standard error codes are handled. On a response with status 'success' for the N-CREATE or NSET request, the system updates the

state and indicates the same on the User Interface. On a response with status other than 'success' the operation is deemed 'Failed' and the system updates the state and indicates the same on the User interface. If the request has failed or response is not received before the association timeout, the operation is deemed 'Failed' and the system updates the state and indicates the same on the User Interface.

If the operation is 'Failed', detailed message is logged into system log-file and system provides an alternative mechanism to retry the failed operation through the user interface to ensure that transient failures do not affect the feature performance.

3. Proposed Presentation Contexts

The following Table shows the proposed presentation contexts for the PPS Server AE after any of the real-world activity listed in section 2.2.3 Sequencing of Real-World Activities, is initiated.

Presentation Context Table - Proposed

Name	Abstract Syntax		Transfer Syntax		Role	Extended Negotiation
	UID		Name List	UID List		
Modality Performed Procedure Step	1.2.840.1.10008.3.1.2.3.3		Implicit VR Little Endian	1.2.840.10008.1.2	SCU	None

3.1 SOP Specific DICOM Conformance Statement for MPPS SOP class.

If the remote AE does not support the proposed Presentation Context, an appropriate error message logged. Only one association is opened at a time.

All the operations used by this SOP class support an association timer, which is configurable. The timer is started when a request (association request, NCREATE request or N-SET request) is send and stopped when the respective response is received.

If any of the above timers expires the association is aborted and the operation inprogress is considered FAILED.

PPS from Acquisition System with MWL data

The system has a Modality Worklist Server AE installed. Worklist information is obtained from HIS/RIS system through the use of Basic Worklist Management Service. Use of the information retrieved in the creation of Image SOP instance is described in the Modality Worklist Conformance Statement. Use of the information retrieved in MPPS SOP instances is described later in this document.

The system initiates a 'Start PPS' on Start Exam prior to going into the Acquisition Mode. The system retrieves necessary information related to the Scheduled Procedure Step from Modality Worklist Server. PPA Server AE initiates a MPPS (Modality Performed Procedure Step) N-CREATE request to the remote AE (MPPS SCP), in order to create a MPPS SOP instance at the remote AE.

The MPPS SCP returns response indicating the success/failure of the request execution. The PPS state information is updated in the system based on the response data, and is presented to the user. The DICOM association is closed.

System includes the necessary information related to Scheduled Procedure Steps and the Performed Procedure Step in the image instances created. At the end of image acquisition, system initiates a 'Complete PPS' or 'Discontinue PPS' based on the operator's choice on the User Interface provided. PPS Server AE initiates a MPPS N-SET request to the remote AE, in-order to update the MPPS SOP instance that is already created. The N-SET is sent over a new DICOM association.

The remote AE returns response indicating the success/failure of the request association. The PPS state information is updated in the system based on the response data, and is presented to the user.

At the end of Image Acquisition if the User has chosen the Suspend option, the PPS is deferred and the user can either 'Complete' or 'Discontinue' PPS at a later time. The N-SET is sent over a new DICOM association.

The remote AE returns response indicating the success/failure of the request association. The PPS state information is updated in the system based on the response data, and is presented to the user.

## 2.4 COMMUNICATION PROFILES

### 2.4.1 Supported Communication Stacks (PS 3.8, PS 3.9)

DICOM Upper Layer Protocol is supported using TCP/IP as specified in DICOM PS 3.8.

### 2.4.2 OSI Stack

OSI stack not supported.

#### 2.4.2.1 Physical Media Support

Not Applicable.

### 2.4.3 TCP/IP Stack

The TCP/IP stack is inherited from a LINUX Operating System.

#### 2.4.3.1 API

Not applicable to this product.

#### 2.4.3.2 Physical Media Support

DICOM is indifferent to the Physical medium over which TCP/IP executes (e.g. Ethernet V2.0, IEEE 802.3, ATM, FDDI)

Note: For more information about the Physical Media available on Acquisition Workstation, please refer to the Product Data Sheet.

### 2.4.4 Point-to-Point Stack

A 50-pin ACR-NEMA connection is not applicable to this product.

## 2.5 EXTENSIONS / SPECIALIZATIONS / PRIVATIZATIONS

### 2.5.1 Standard Extended /Specialized/Private SOPs

None supported.

### 2.5.2 Private Transfer Syntaxes

None supported.

## 2.6 CONFIGURATION

### 2.6.1 AE Title/Presentation Address Mapping

The Acquisition System allows the User to “Add”, “Remove”, “Update” the mapping of remote AE titles to IP addresses and Ports. These options can be selected from the Network Connections displayed when the Utilities Button is clicked on the Worklist.

The system allows the configuration of the following

DICOM SERVER AE:

AE Title, IP Address, Port Number

WORKLIST SERVER AE:

AE Title, IP Address, Port Number

STORAGE COMMITMENT SERVER AE:

Note: AE Title, IP Address, Port Number

### 2.6.2 Configurable Parameters

The following fields are configurable:

- Local IP Address
- Local IP Netmask
- Default Router IP Address for local network. Only one default router IP Address can be configured for all remote nodes.

The Local Listening Port Number for C-STORE SCP DICOM service is not configurable and set to 4010

The Local Listening Port Number for STORAGE COMMITMENT DICOM service is not configurable and set to 4010

The following fields are configurable for every remote DICOM AE including

Worklist provider:

- Remote AE Title
- Remote IP Address
- Listening TCP/IP Port Number

## 2.7 SUPPORT OF EXTENDED CHARACTER SETS

The Acquisition Workstation will support only the ISO\_IR 100 (ISO 8859-1:1987 Latin alphabet N 1. supplementary set) as extended character sets.

## 2.8 SECURITY PROFILES

The product does not conform to any defined DICOM Security Profiles.

It is assumed that the product is used within a secured environment. It is assumed that a secured environment includes at a minimum:

1. Firewall or router protections to ensure that only approved external hosts have network access to the product.
2. Firewall or router protections to ensure that the product only has network access to approved external hosts and services.
3. Any communications with external hosts and services outside the locally secured environment use appropriate secure network channels (such as a Virtual Private Network (VPN)) The Acquisition Workstation will support only the ISO\_IR 100 (ISO 8859-1:1987 Latin alphabet N 1. supplementary set) as extended character sets.

# Section 3.0 MEDIA STORAGE CONFORMANCE STATEMENT

## 3.1 INTRODUCTION

This section of the DICOM conformance statement specifies the Acquisition Workstation compliance to DICOM Media Interchange. It details the DICOM Media Storage Application Profiles and roles that are supported by this product.

This station provides capabilities to DICOM interchange on CD-Rs (Compact Disc-Recordable), DVD+R (Digital Video Disk - Recordable) and on CDROMs (Compact Disc Read Only Memory). The Acquisition Workstation works with Digital X-ray (DX) For Processing, and Digital X-ray (DX) For Presentation images.

Note that the format of this section strictly follows the format defined in DICOM Standard PS 3.2 (Conformance). Please refer to that part of the standard while reading this section.

## 3.2 IMPLEMENTATION MODEL

### 3.2.1 Application Data Flow Diagram

The Basic and Specific Application models for the CDR, DVDR devices and the CDROM device are shown in the following Illustrations:

#### SPECIFIC AE APPLICATION MODEL FOR THE CDR DEVICE

- Description of the data Flow Diagram for the CD-R and DVD+R devices.

The DICOM ARCHIVE/RESTORE functionality for the CD-R and DVD+R devices are handled by the CD-R/DVD+R/CDROM DICOM Media Server Application Entity (AE). The CD-R/DVD+R/CDROM DICOM Media Server Application Entity (AE) is commanded by the user to perform DICOM services operating on the DICOM media through the use of buttons and menu selections on the graphical user interface of the station.

The user requests the creation of a DICOM file set and the writing of this DICOM File Set on a blank CD-R or blank DVDR by selecting images in the local Browser, and by a drag and drop of those images on the CD-R icon. Images are saved on a mono-session disk in a one shot operation.

The user can request the reading of a DICOM file set written on a CDROM or DVD by selecting the CD-R or DVD+R drive as the active archive device, and browsing the archive using the "Query" Item of the Archive drop down menu, and then restore the selected items by a drag and drop on the local browser icon or by clicking on the suitable restore buttons.

The Application models for the CD-R/DVD+R device are shown in Illustration 3– 1.

#### ILLUSTRATION SECTION 3–1

#### SPECIFIC AE APPLICATION MODEL

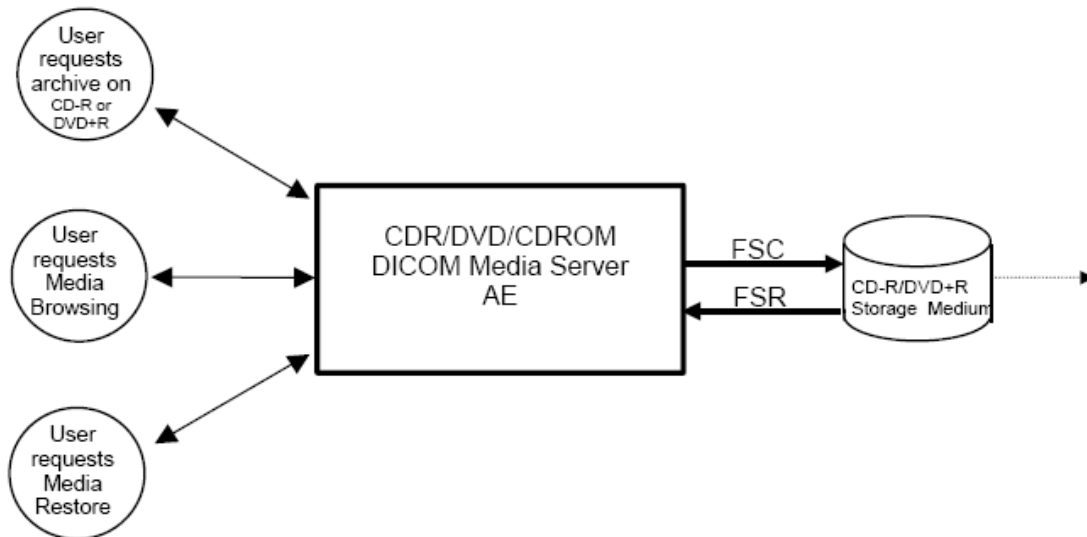

- Description of the data Flow Diagram for the CDROM device.

The DICOM RESTORE functionality for the CDROM device is handled by the CDROM DICOM Media Server Application Entity (AE). The CDROM DICOM Media Server Application Entity (AE) is commanded by the user to perform DICOM services operating on the DICOM media through the use of buttons and menu selections on the graphical user interface of the station.

The user can request the reading of a DICOM file set written on a CDROM by selecting the CDR drive as the active archive device, and browsing the archive using the “Query” Item of the Archive drop down menu, and then restore the selected items by a drag and drop on the local browser icon or by clicking on the suitable restore buttons. The Application model for the CDROM device is shown in Illustration 3-2.

**ILLUSTRATION 3-2**

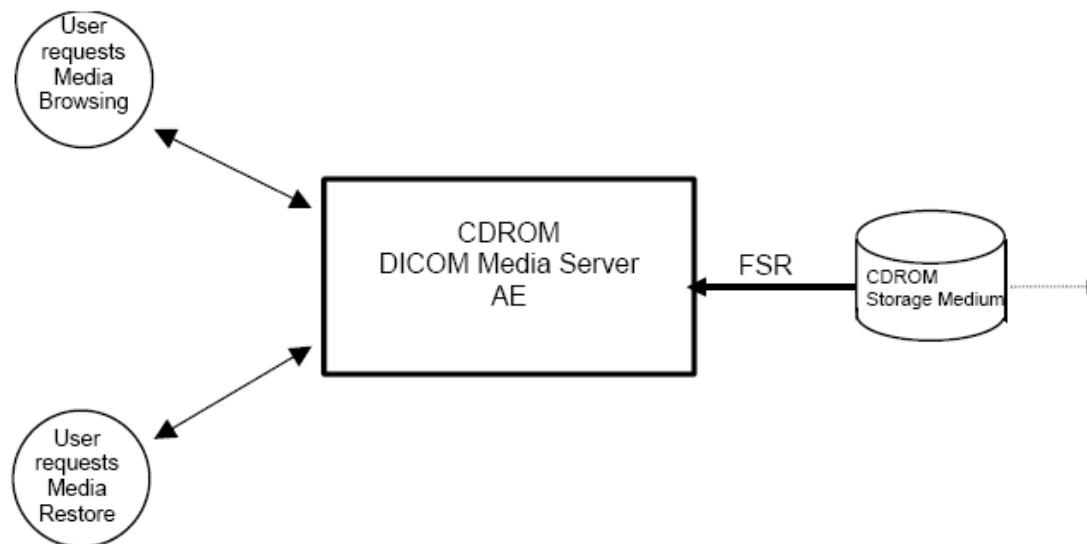

**3.2.2 Functional Definition of AE's**

**3.2.2.1 Functional Definition of the DICOM Media Server AE**

1. Functional definition of the CDR/DVDR/CDROM DICOM Media Server AE

The CDR/CDROM DICOM Media Server Application Entity supports the following functions:

- Has access to patient demographics and pixel data in the local database.
- Can generate a DICOM File Set (FSC) for Digital X-ray (DX) For Processing and DX For Presentation data types in a one shot activity.
- Can write a DICOM File Set (FSC) on a CD-R and DVDR in mono-session.
- Can read a DICOM File Set (FSR) on a CDROM, CDR and DVDR.

**3.2.3 Sequencing Requirements**

Non-Applicable for writing a CD-R or DVD+R.

For restoring images from a CD-R/CD-ROM:

1. Browse the CD-R/DVD+R/CD-ROM
2. User selects images to be restored from CD-R/DVD+R/CD-ROM to the system.
3. System restores Images.

**3.2.4 File Meta Information Options (See PS3.10)**

The File Meta-Information for this implementation is:

**Table 3-1 : Discovery XR656 GII**

File Meta-Information Version	1
Discovery XR656 Acquisition Workstation Implementation UID	1.2.840.113619.6.369
Implementation Version Name	Discovery XR656

**Table 3-2 : Optima XR646**

File Meta-Information Version	1
Optima XR646 Acquisition Workstation Implementation UID	1.2.840.113619.6.370
Implementation Version Name	Optima XR646

**Table 3-3 : Definium 6000 (V)**

File Meta-Information Version	1
Definium 6000 Acquisition Workstation Implementation UID	1.2.840.113619.6.370
Implementation Version Name	Optima XR646

**Table 3-4 : Discovery XR656**

File Meta-Information Version	1
Discovery XR656 Acquisition Workstation Implementation UID	1.2.840.113619.6.203
Implementation Version Name	Global 1 Platform

### 3.3 AE SPECIFICATIONS

#### 3.3.1 DICOM CDR/CDROM SERVER AE Specification

The DICOM CDR/DVDR/CDROM SERVER Application Entity provides standard conformance to DICOM Interchange Option of the Media Storage Service Class. The application Profiles and roles are listed below.

Supported Application Profile	Real World Activity	Role (See Notes)	Description
STD-GEN-CD	Browse CD	FSR	Interchange
STD-GEN-CD	Restore CD	FSR	Interchange
STD-GEN-CD	Archive CD	FSC	Interchange

Note: Archive is available only on blank CD-Rs and DVDRs.

Note: Browse and Restore is possible on CD-R, DVDR and CD-ROM

##### 3.3.1.1 File Meta Information for the DICOM CDR/DVDR/CDROM Application Entity

Following are the values set in the File Meta Information for this AE Title:

Source Application Entity Title | Set to system hostname

##### 3.3.1.2 Real-World Activities for the DICOM CDR/DVDR/CDROM Application Entity

###### 1. Real-World Activity (RWA) "Browse CD/DVDR"

The CD-R/DVD+R/CDROM DICOM Media Server AE acts as an FSR using the interchange option when requested to browse the CD.

When the CD-R/DVDR/CDROM DICOM Media Server AE is requested to provide a directory listing, it reads the File-set and displays the DICOMDIR directory entries, according to the PATIENT, STUDY, SERIES, IMAGE paradigm.

If the DICOMDIR file is not found in the File-set, the CD is ejected out of the drive.

A.) Media Storage Application Profile for the RWA "Browse CD":

For the list of Application Profiles that invoke this AE for the Browse CD/DVD RWA, see the Table in Section 3.3.1

> Options:

Following are the SOP Classes supported by the RWA "Browse CD/DVD":

Information Object Definition	SOP Class UID	Transfer Syntax	Transfer Syntax UID
Media Storage Directory Storage	1.2.840.10008.1.3.10	Explicit VR Little Endian	1.2.840.10008.1.2.1

###### B.) 1.2.2 Real-World Activity (RWA) "Restore CD/DVD"

The CD-R/CDROM DICOM Media Server AE acts as an FSR using the interchange option when requested to copy SOP instances from the CD/DVD to the local database.

The user selects the SOP instances that he wants the DICOM Media Server AE to copy on the local database by a drag and drop on the local browser icon or by clicking on the suitable restore buttons. Once selected, the SOP instances are copied from the media to the local database.

Only, the SOP classes supported by the station are declared to the database in a transfer syntax supported by the station.



> Media Storage Application Profile for RWA “Restore CD/DVD”:

For the list of Application Profiles that invoke this AE for the Restore CD/DVD RWA, see the Table in Section 3.3.1.

> Options:

Following are the SOP Classes supported by the RWA “Restore CD/DVD”:

Information Object Definition	SOP Class UID	Transfer Syntax	Transfer Syntax UID
Media Storage Directory Storage	1.2.840.10008.1.3.10	Explicit VR Little Endian	1.2.840.10008.1.2.1
Digital X-ray For Processing Image Storage	1.2.840.10008.5.1.4.1.1.1.1.1	Explicit VR Little Endian	1.2.840.10008.1.2.1
Digital X-ray For Presentation Image Storage	1.2.840.10008.5.1.4.1.1.1.1	Explicit VR Little Endian	1.2.840.10008.1.2.1
Secondary Capture Image Storage	1.2.840.10008.5.1.4.1.1.7	Explicit VR Little Endian	1.2.840.10008.1.2.1

**Note:** Secondary Captures display is not supported.

**Note:** Other objects such as Digital Mammography X-ray Images can be restored but there are some limitations on the system working with such objects.

C.) Real-World Activity (RWA) “Archive CD/DVD”

The CD-R/DVD+R/CDROM DICOM Media Server acts as an FSC using the interchange option when requested to copy SOP Instances from the local database to the CD-R.

The user has to insert a blank CD/DVD into the CD-R/DVD+R drive. Then, the user selects the entries in the local database that he wants the CDR/DVD+R/CDROM DICOM Media Server to copy onto the CD/DVD.

A confirmation pop-up that indicates what can be archived on the CD-R/DVDR is displayed.

Before writing the CD, the DICOM Media Server checks for the following conditions:

- The inserted media is blank and writable. If the condition is not met, an error is displayed and the CD/DVD is ejected.
- The corresponding SOP instances have been encoded with the ISO\_IR 100 Specific Character Set or DICOM Default Character Set.

The corresponding SOP instances are set to the transfer syntax defined by the application and copied to the CD/DVD. Unknown Private Data Elements are coded as “UN” for Unknown.

> Media Storage Application Profile for RWA “Archive CD”:

This AE can use the STD-GEN-CD profile for the RWA Archive CD/DVD.

Please refer to the Table in Section 3.3.1.

> Options:

Following are the SOP Classes supported by the RWA “Archive CD/DVD”:

Information Object Definition	SOP Class UID	Transfer Syntax	Transfer Syntax UID
Media Storage Directory Storage	1.2.840.10008.1.3.10	Explicit VR Little Endian	1.2.840.10008.1.2.1
Digital X-ray For Processing Image Storage	1.2.840.10008.5.1.4.1.1.1.1.1	Explicit VR Little Endian	1.2.840.10008.1.2.1
Digital X-ray For Presentation Image Storage	1.2.840.10008.5.1.4.1.1.1.1	Explicit VR Little Endian	1.2.840.10008.1.2.1
Secondary Capture Image Storage	1.2.840.10008.5.1.4.1.1.7	Explicit VR Little Endian	1.2.840.10008.1.2.1

### 3.4 AUGMENTED AND PRIVATE APPLICATION PROFILES

No augmented/private profile is implemented.

## 3.5 EXTENSIONS, SPECIALIZATIONS, PRIVATIZATIONS OF SOP CLASSES & TRANSFER SYNTAXES

### 3.5.1 Extensions, Specializations, and Privatizations of SOP Classes

#### 3.5.1.1 SOP Specific Conformance Statement for SOP Media Storage Directory

The following keys are added as Type 3 data elements in the Basic Directory IOD:

Key Attribute	Tag	Directory Record Type
Image Type	(0008,0008)	IMAGE
Institution Name	(0008,0080)	SERIES
Institution Address	(0008,0081)	SERIES
Attending Physician's Name	(0008,1050)	SERIES
Series Description	(0008,103E)	SERIES
Manufacturer	(0008,1090)	SERIES
Patient's Birth Date	(0010,0030)	PATIENT
Patient's Sex	(0010,0040)	PATIENT
Body Part Examined	(0018,0015)	IMAGE
Acquisition Device Processing Description	(0018,1400)	IMAGE
Image Laterality	(0020,0062)	IMAGE
Rows	(0028,0010)	IMAGE
Columns	(0028,0011)	IMAGE

Note: The CD-ROM/DVD Browser displays less information than the local Browser.

#### 3.5.2 Private Transfer Syntax Specification

No private Transfer Syntax is written on media by the described DICOM DVDR/CDR/CDROM SERVER AE of Acquisition Workstation.

## 3.6 CONFIGURATION

The source AE Title encoded in the File Meta-Information cannot be modified.

## 3.7 SUPPORT OF EXTENDED CHARACTER SETS

The Acquisition Workstation will support only the ISO\_IR 100 (ISO 8859-1:1987 Latin alphabet N 1. supplementary set) as extended character sets. Any incoming SOP instance that is encoded using another extended character set will not be installed in the local database.

# Section 4.0 DIGITAL X-RAY INFORMATION OBJECT IMPLEMENTATION

## 4.1 INTRODUCTION

This section specifies the use of the DICOM Digital X-ray (DX) Image IOD to represent the information included in DX images produced by this implementation. Corresponding attributes are conveyed using the module construct. The contents of this section are:

- 4.2 - IOD Description
- 4.3 - IOD Entity-Relationship Model
- 4.4 - IOD Module Table
- 4.5- IOD Module Definition

## 4.2 DX IOD IMPLEMENTATION

The DX Image IOD is used in two SOP classes as defined in PS3.4 Storage Service Class, a SOP Class for storage of images intended for presentation, and a SOP class for storage of images intended for further processing before presentation. These are distinguished by their SOP Class UID and by the Enumerated Value of the mandatory Attribute in DX Series Module, Presentation Intent Type (0008,0068).

## 4.3 DX ENTITY-RELATIONSHIP MODEL

The Entity-Relationship diagram for the DX Image interoperability schema is shown in Illustration SECTION 4-1. In this figure, the following diagrammatic convention is established to represent the information organization:

- each entity is represented by a rectangular box
- each relationship is represented by a diamond shaped box.
- the fact that a relationship exists between two entities is depicted by lines connecting the corresponding entity boxes to the relationship boxes.

The relationships are fully defined with the maximum number of possible entities in the relationship shown. In other words, the relationship between Series and Image can have up to n Images per Series, but the Patient to Study relationship has 1 Study for each Patient (a Patient can have more than one Study on the system, however each Study will contain all of the information pertaining to that Patient).

### ILLUSTRATION SECTION 4-1 DX IMAGE ENTITY RELATIONSHIP DIAGRAM

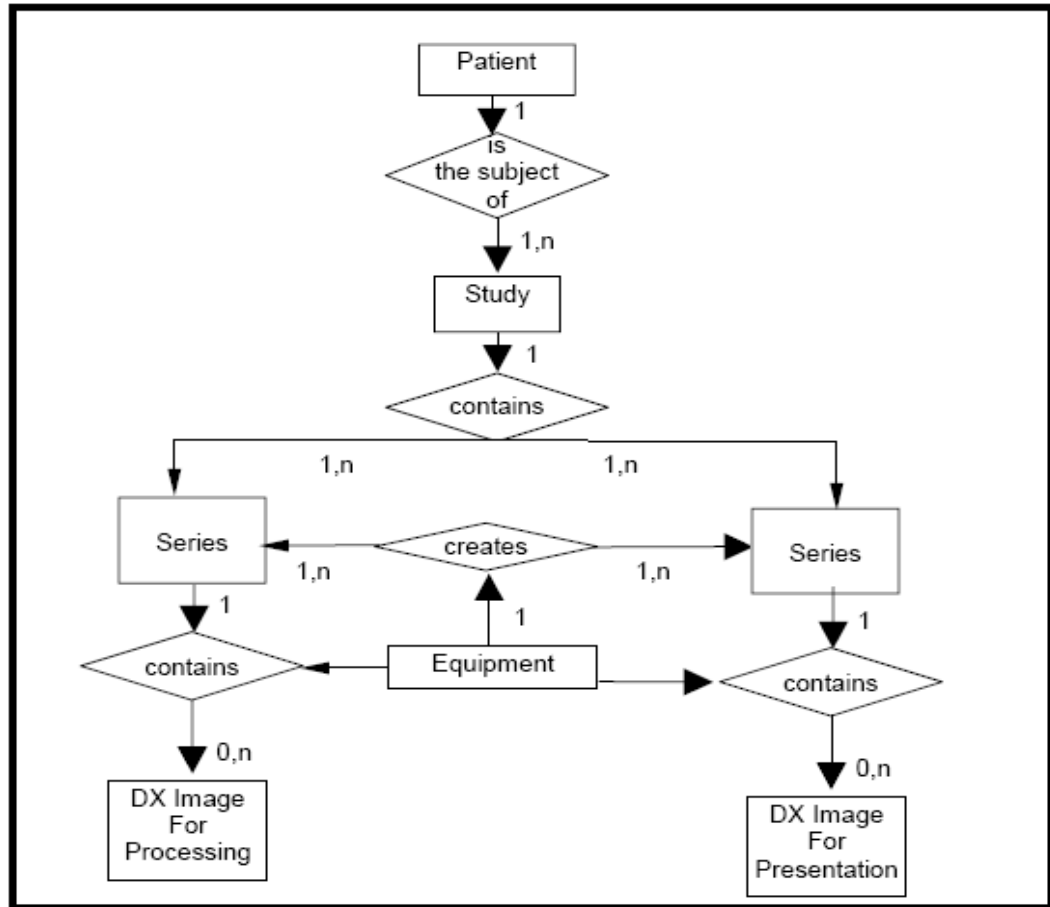

### 4.3.1 Entity Descriptions

Please refer to DICOM Standard Part 3 (Information Object Definitions) and Supplement 32 for a description of each of the entities contained within the DX Information Object.

### 4.3.2 Acquisition Workstation Mapping of DICOM entities

DICOM	Acquisition Workstation Entity
Patient	Patient
Study	Study
Series	Series
Image	Image
Frame	Not Applicable

Table 4-1 MAPPING OF DICOM ENTITIES TO ACQUISITION WORKSTATION ENTITIES

## 4.4 IOD MODULE TABLE

Within an entity of the DICOM DX IOD, attributes are grouped into related sets of attributes. A set of related attributes is termed a module. A module facilitates the understanding of the semantics concerning the attributes and how the attributes are related with each other. A module grouping does not infer any encoding of information into datasets.

Below Table identifies the defined modules within the entities that comprise the DICOM DX IOD. Modules are identified by Module Name.

See DICOM Part 3 for a complete definition of the entities, modules, and attributes.

### 4.4.1 Discovery XR656 GII and Discovery XR656 IOD MODULE TABLE

Entity Name	Module Name	Section Reference
Patient	Patient	4.5.1.1
Study	General Study	4.5.2.1
Series	General Series	4.5.3.1
	DX Series	4.5.3.2
Equipment	General Equipment	4.5.4.1
Image	General Image	4.5.5.1
	Image Pixel	4.5.5.2
	DX Anatomy Imaged	4.5.5.3
	DX Image	4.5.5.4
	DX Detector	4.5.5.5
	X-ray Collimator	4.5.5.6
	DX Positioning	4.5.5.7
	X-ray Acquisition Dose	4.5.5.8
	X-ray Generation	4.5.5.9
	X-ray Filtration	4.5.5.10
	X-ray Grid	4.5.5.11
	Overlay Plane	4.5.5.12
	VOI LUT	4.5.5.13
	Acquisition Context	4.5.5.14
	SOP Common	4.5.5.15
	Icon Image	4.5.5.16
	Frame of Reference	4.5.5.17
X-ray Tomography Acquisition	X-ray Tomography Acquisition	4.5.5.18
	XA Positioner	4.5.5.19
Image Plane	4.5.5.20	
Private Module	Application module	4.5.6

**Table 4-2 : Discovery XR656 GII and Discovery XR656 DX IMAGE IOD MODULES**

## 4.4.2 Optima XR646 and Definium 6000 IOD MODULE TABLE

Entity Name	Module Name	Section Reference
Patient	Patient	4.5.1.1
Study	General Study	4.5.2.1
Series	General Series	4.5.3.1
	DX Series	4.5.3.2
Equipment	General Equipment	4.5.4.1
Image	General Image	4.5.5.1
	Image Pixel	4.5.5.2
	DX Anatomy Imaged	4.5.5.3
	DX Image	4.5.5.4
	DX Detector	4.5.5.5
	X-ray Collimator	4.5.5.6
	DX Positioning	4.5.5.7
	X-ray Acquisition Dose	4.5.5.8
	X-ray Generation	4.5.5.9
	X-ray Filtration	4.5.5.10
	X-ray Grid	4.5.5.11
	Overlay Plane	4.5.5.12
	VOI LUT	4.5.5.13
	Acquisition Context	4.5.5.14
	SOP Common	4.5.5.15
	Icon Image	4.5.5.16
Private Module	Application module	4.5.6

**Table 4-3 : Optima XR646 and Definium 6000 (V) DX IMAGE IOD MODULES**

## 4.5 INFORMATION MODULE DEFINITIONS

Please refer to DICOM Standard Part 3 (Information Object Definitions) for a description of each of the entities and modules contained within the DX Information Object.

The following modules are included to convey Enumerated Values, Defined Terms, and Optional Attributes supported. Type 1 & Type 2 Attributes are also included for completeness and to define what values they may take and where these values are obtained from. It should be noted that they are the same ones as defined in the DICOM Standard Part 3 (Information Object Definitions).

### 4.5.1 Common Patient Entity Modules

#### 4.5.1.1 Patient Module

This section specifies the Attributes of the Patient that describe and identify the Patient who is the subject of a diagnostic Study. This Module contains Attributes of the patient that are needed for diagnostic interpretation of the Image and are common for all studies performed on the patient.

Attribute Name	Tag	Type	Attribute Description
Referenced Patient Sequence	(0008,1120)	3	This information is present only if retrieved from HISRIS.
>Referenced SOP Class UID	(0008,1150)	1C	

**Table 4-4 PATIENT MODULE ATTRIBUTES**

>Referenced SOP Instance UID	(0008,1155)	1C	
Patient's Name	(0010,0010)	2	The value is loaded from HIS/RIS or is entered by the user using the Medical Procedure Card.
Patient ID	(0010,0020)	2	The value is loaded from HIS/RIS or is entered by the user using the Medical Procedure Card.
Patient's Birth Date	(0010,0030)	2	The value is loaded from HIS/RIS or is entered by the user using the Medical Procedure Card.
Patient's Sex	(0010,0040)	2	The value is loaded from HIS/RIS or is entered by the user using the Medical Procedure Card.

**Table 4-4 PATIENT MODULE ATTRIBUTES**

### 4.5.2 Common Study Entity Modules

The following Study IE Modules are common to all Composite Image IODs that reference the Study IE. These Modules contain Attributes of the patient and study that are needed for diagnostic interpretation of the image.

#### 4.5.2.1 General Study Module

This section specifies the Attributes that describe and identify the Study performed upon the Patient.

Attribute Name	Tag	Type	Attribute Description
Study Date	(0008,0020)	2	The system set to today's date when generating a new study.
Study Time	(0008,0030)	2	The system set to current time when generating a new study.
Accession Number	(0008,0050)	2	The value is loaded from HIS/RIS or is entered by the user using the Medical Procedure Card.
Referring Physician's Name	(0008,0090)	2	The value is loaded from HIS/RIS .
Study Description	(0008,1030)	3	The value is loaded from HIS/RIS or is entered by the user using the Medical Procedure Card.
Referenced Study Sequence	(0008,1110)	3	This information is present only if retrieved from HISRIS.
>Referenced SOP Class UID	(0008,1150)	1C	
>Referenced SOP Instance UID	(0008,1155)	1C	
Study Instance UID	(0020,000D)	1	The value is loaded from HIS/RIS or is generated by the system.
Study ID	(0020,0010)	2	The value is loaded from HIS/RIS or is generated by the system.

**Table 4-5 GENERAL STUDY MODULE ATTRIBUTES**

### 4.5.3 Common Series Entity Modules

The following Series IE Modules are common to all Composite Image IODs that reference the Series IE.

#### 4.5.3.1 General Series Module

This section specifies the Attributes that identify and describe general information about the Series within a Study.

Attribute Name	Tag	Type	Attribute Description
Series Date	(0008,0021)	3	The system sets it to today's date when generating a new series.
Series Time	(0008,0031)	3	The system sets it to current time when generating a new series.
Modality	(0008,0060)	1	Defined Terms: DX = Digital X-ray
Performing Physicians' Name	(0008,1050)	3	The value is loaded from HIS/RIS or is entered by the user using the Medical Procedure Card.
Series Description	(0008,103E)	3	The value is loaded from HIS/RIS or is entered by the user using the Medical Procedure Card.
Operators' Name	(0008,1070)	3	The value is loaded from HIS/RIS or is entered by the user using the Medical Procedure Card.
Body Part Examined	(0018,0015)	3	Set to body part examined according to protocol used for acquisition.
Series Instance UID	(0020,000E)	1	UID is generated by the system.
Series Number	(0020,0011)	2	Number generated by the system.
>Scheduled Procedure Step Description	(0040,0007)	3	This information is present only if retrieved from HISRIS.
>Scheduled Action Item Code Sequence	(0040,0008)	3	This information is present only if retrieved from HISRIS.
>Scheduled Procedure Step ID	(0040,0009)	1C	This information is present only if retrieved from HISRIS.
Request Attributes Sequence	(0040,0275)	3	This information is present only if retrieved from HISRIS.
>Requested Procedure ID	(0040,1001)	1C	This information is present only if retrieved from HISRIS.

**Table 4-6 GENERAL SERIES MODULE ATTRIBUTES**

#### 4.5.3.2 DX Series Module

This Module contains IOD Attributes that describe a Digital X-ray series performed on the patient.

Attribute Name	Tag	Type	Attribute Description
Modality	(0008,0060)	1	Defined Terms: DX = Digital X-ray
Presentation Intent Type	(0008,0068)	1	Enumerated Values: FOR PRESENTATION FOR PROCESSING

**Table 4-7 DX SERIES MODULE ATTRIBUTES**

#### 4.5.4 Common Equipment Entity Modules

The following Equipment IE Module is common to all Composite Image IODs that reference the Equipment IE.



**4.5.4.1 General Equipment Module**

This section specifies the Attributes that identify and describe the piece of equipment that produced a Series of Images.

Attribute Name	Tag	Type	Attribute Description
Manufacturer	(0008,0070)	2	Value set to "GE Healthcare"
Institution Name	(0008,0080)	3	Value comes from configuration file
Institution Address	(0008,0081)	3	Value comes from configuration file
Station Name	(0008,1010)	3	Value comes from configuration file
Institutional Department Name	(0008,1040)	3	Value comes from configuration file
Manufacturer's Model Name	(0008,1090)	3	For Discovery XR656 GII product, value set to "Discovery XR656". For Optima XR646 product, value set to "Optima XR646". For Definium 6000 (V) product, value set to "Definium 6000". For Discovery XR656 product, value set to "Global 1 Platform".
Software Versions	(0018,1020)	3	Value set to Software version xx.yy, where xx.yy is the release of the SW that generated the image.

**Table 4-8 GENERAL EQUIPMENT MODULE ATTRIBUTES**

**4.5.5 Common Image Entity Modules**

The following Image IE Modules are common to all Composite Image IODs that reference the Image IE.

**4.5.5.1 General Image Module**

This section specifies the Attributes that identify and describe an image within a particular series.

Attribute Name	Tag	Type	Attribute Description
Image Type	(0008,0008)	3	Value 1 Enumerated Values are: ORIGINAL identifies an Original Image DERIVED identifies a Derived Image Value 2 Enumerated Values are: PRIMARY identifies a Primary Image SECONDARY identifies a Secondary Image Value 3 is left EMPTY.
Acquisition Date	(0008,0022)	3	
Content Date	(0008,0023)	2C	Set by the system when building the image. Equal to Acquisition Date in DX For Processing image.
Content Time	(0008,0033)	2C	Set by the system when building the image. Equal to Acquisition Time in DX For Processing image.
Acquisition Time	(0008,0032)	3	
Source Image Sequence	(0008,2112)	3	Only sent in DX for Presentation Images. Tomosynthesis slices will have references of all projection images used for the derivation.

**Table 4-9 GENERAL IMAGE MODULE ATTRIBUTES**

>Referenced SOP Class UID	(0008,1150)	1C	
>Referenced SOP Instance UID	(0008,1155)	1C	
Derivation Description	(0008,2111)	3	Only present in Dual Energy DX For Presentation Images. This field will be set to "DE Subtraction Soft Tissue" for Soft Tissue image and "DE Subtraction Bone" for Bone image. Also present in "For Presentation" images generated by Image Pasting. The values could be "Auto Pasted Image" or "Manual Pasted Image" based on how the images were created / derived.
Instance Number	(0020,0013)	2	Number generated by the system
Patient Orientation	(0020,0020)	2C	Set according to the clinical view. Example: For chest PA, it is set to R/F <b>Note:</b> this tag is configurable in SUIF as per customer request
Quality Control Image	(0028,0300)	3	
Burned In Annotation	(0028,0301)	3	Always set to NO
Lossy Image Compression	(0028,2110)	3	Always set to 00

**Table 4-9 GENERAL IMAGE MODULE ATTRIBUTES**

### 1.1 General Image Attribute Descriptions

#### 1.1.1 Source Image Sequence

Source Image Sequence references the SOP Instance UID of the raw image (DX for Processing image) from which this processed image (DX for Presentation image) was created.

### 4.5.5.2 Image Pixel Module

This section specifies the Attributes that describe the pixel data of the image.

Attribute Name	Tag	Type	Attribute Description
Samples per Pixel	(0028,0002)	1	Always set to 1
Photometric Interpretation	(0028,0004)	1	Set to MONOCHROME1 in DX For Processing images. Set to MONOCHROME2 in DX For Presentation images.
Rows	(0028,0010)	1	<= 2022 For Processing images.
Columns	(0028,0011)	1	<= 2022 For Processing images.
Bits Allocated	(0028,0100)	1	Set to 16
Bits Stored	(0028,0101)	1	Set to 14
High Bit	(0028,0102)	1	Set to 13
Pixel Representation	(0028,0103)	1	Always set to 0000H (unsigned integer)
Pixel Data	(7FE0,0010)	1	

**Table 4-10 IMAGE PIXEL MODULE ATTRIBUTES**

**4.5.5.3 DX Anatomy Imaged Module**

The table in this Section contains IOD Attributes that describe the anatomy contained in a DX IOD.

Attribute Name	Tag	Type	Attribute Description
Image Laterality	(0020,0062)	1	Enumerated Values: R = right L = left U = unpaired B = both left and right
Anatomic Region Sequence	(0008,2218)	2	
>Code Value	(0008,0100)	1C	Set to code corresponding to anatomic region. Example: T-D3000 for Chest T-11501 for Cervical spine
>Coding Scheme Designator	(0008,0102)	1C	Always set to "SNM3"
>Code Meaning	(0008,0104)	1C	Set to code meaning corresponding to anatomic region sequence Code Value. Example: Set to Chest if code = T-D3000 Set to Cervical spine if code = T-11501

**Table 4-11 DX ANATOMY IMAGED MODULE ATTRIBUTES**

**4.5.5.4 DX Image Module**

The table in this Section contains IOD Attributes that describe a DX image by specializing Attributes of the General Image and Image Pixel Modules, and adding additional attributes.

Attribute Name	Tag	Type	Attribute Description
Image Type	(0008,0008)	1	Value 1 Enumerated Values are: ORIGINAL identifies an Original Image DERIVED identifies a Derived Image Value 2 Enumerated Values are: PRIMARY identifies a Primary Image SECONDARY identifies a Secondary Image Value 3 is left EMPTY.
Samples Per Pixel	(0028,0002)	1	Always set to 1
Photometric Interpretation	(0028,0004)	1	Set to MONOCHROME1 in DX For Processing images. Set to MONOCHROME2 in DX For Presentation images.
Bits Allocated	(0028,0100)	1	Set to 16
Bits Stored	(0028,0101)	1	Set to 14
High Bit	(0028,0102)	1	Set to 13
Pixel Representation	(0028,0103)	1	Always set to 0000H (unsigned integer)
Pixel Intensity Relationship	(0028,1040)	1	Set to LIN in DX For Processing images. Set to LOG in DX For Presentation images.
Pixel Intensity Relationship Sign	(0028,1041)	1	Set to +1 in DX For Processing images. Set to -1 in DX For Presentation images.
Rescale Intercept	(0028,1052)	1	Always set to 0.
Rescale Slope	(0028,1053)	1	Always set to 1.
Rescale Type	(0028,1054)	1	Always set to US.
Presentation LUT Shape	(2050,0020)	1	Set to "INVERSE" in DX For Processing images. Set to "IDENTITY" in DX For Presentation images.

**Table 4-12 DX IMAGE MODULE ATTRIBUTES**

Lossy Image Compression	(0028,2110)	1	Always set to 00
Derivation Description	(0008,2111)	3	Only present in Dual Energy DX For Presentation Images. This field will be set to "DE Subtraction Soft Tissue" for Soft Tissue image and "DE Subtraction Bone" for Bone image. Also present in "For Presentation" images generated by Image Pasting. The values could be "Auto Pasted Image" or "Manual Pasted Image" based on how the images were created / derived.
Acquisition Device Processing Description	(0018,1400)	3	Sent only in DX For Presentation Images. Set to the processing look code used to process the image.
Patient Orientation	(0020,0020)	1	Set according to the clinical view. Example: For chest PA, it is set to R/F <b>Note:</b> this tag is configurable in SUIF as per customer request
Burned In Annotation	(0028,0301)	1	Always set to NO
VOI LUT Sequence	(0028,3010)	1C	Up to 3 items can be present in this sequence. Sequence is only present when the system is configured to generate the VOI LUT Sequence.
Window Center	(0028,1050)	1C	Sent in DX For Presentation Images. Up to three values are present in the For Presentation DX images.
Window Width	(0028,1051)	1C	Sent in DX For Presentation Images. Up to three values are present in the For Presentation DX images.
Window Center and Width Explanation	(0028,1055)	3	Sent in DX For Presentation Images. Up to three values are present.
> LUT Descriptor	(0028,3002)	1C	Specifies the format of the LUT data in this sequence. Required if the VOI LUT Sequence is sent.
> LUT Explanation	(0028,3003)	3	Free form text explanation of the meaning of the LUT.
> LUT Data	(0028,3006)	1C	LUT data in this sequence. Required if the VOI LUT Sequence is sent.

**Table 4-12 DX IMAGE MODULE ATTRIBUTES**

#### 4.5.5.5 DX Detector Module

The table in this Section contains IOD Attributes that describe a DX detector.

Attribute Name	Tag	Type	Attribute Description
Field of View Shape	(0018,1147)	3	Set to "RECTANGLE"
Field of View Dimensions	(0018,1149)	3	Dimensions in mm of the field of view, that is the image pixels stored in Pixel Data (7FE0, 0010). Row dimension / Columns dimension Note: 90 degree rotations sway Row / Columns values
Imager Pixel Spacing	(0018,1164)	1	Physical distance measured at the tabletop between the center of each image pixel projection specified by Row dimension and Column dimension. It should not be assumed to be always equal to Detector Element Spacing value. Imager Pixel Spacing = Detector Element Spacing * (Distance Source to Patient Barrier / Distance Source to Detector)
Sensitivity	(0018,6000)	3	Detector sensitivity in manufacturer specific units.
Detector Temperature	(0018,7001)	3	Sent if available
Detector Type	(0018,7004)	2	Set to "SCINTILLATOR"

**Table 4-13 DX DETECTOR MODULE ATTRIBUTES**

Detector Configuration	(0018,7005)	3	Set to "AREA"
Detector ID	(0018,700A)	3	Sent if available
Detector Binning	(0018,701A)	3	Set to 1/1
Detector Element Physical Size	(0018,7020)	3	Value 1 set to row physical dimension in mm. Value 2 set to column physical dimension in mm.
Detector Element Spacing	(0018,7022)	3	Physical distance between the center of each detector element specified by Row dimension and column dimension.
Detector Active Shape	(0018,7024)	3	Set to "RECTANGLE"
Detector Active Dimensions	(0018,7026)	3	Value 1 set to row active dimension in mm. Value 2 set to column active dimension in mm.
Field of View Origin	(0018,7030)	1C	Coordinates of the FOV upper left corner relative to the Processing Image.
Field of View Rotation	(0018,7032)	1C	Set to value of clockwise rotation in degrees of Field of View related to the physical detector. Sent if Field of View Horizontal Flip is sent.
Field of View Horizontal Flip	(0018,7034)	1C	Enumerated values: YES NO Sent if Field of View Rotation is sent.

**Table 4-13 DX DETECTOR MODULE ATTRIBUTES**

### 4.5.5.6 X-ray Collimator Module

The DICOM optional X-ray Collimator module is always provided and describes the collimation applied on the acquired DX image.

The table in this Section contains IOD Attributes that describe the collimation applied while acquiring the DX image.

Attribute Name	Tag	Type	Attribute Description
Collimator Shape	(0018,1700)	1	Set to "POLYGONAL". Not present in Tomo Slice images
Collimator Vertices	(0018,1720)	1C	Vertices of the polygonal collimator. It contains the vertices coordinates of the collimator as follows: row of the origin vertex column of the origin vertex then the next vertices coordinates. Sent if Collimator shape is sent as POLYGONAL. Not present in Tomo Slice images

**Table 4-14 X-RAY COLLIMATOR MODULE ATTRIBUTES**

### 4.5.5.7 DX Positioning Module

The table in this Section contains IOD Attributes that describe the positioning used in acquiring the DX image.

Attribute Name	Tag	Type	Attribute Description
View Position	(0018,5101)	3	It consists of View information of the acquired image such as PA, AP, LAT.
View Code Sequence	(0054,0220)	3	One item is sent in this sequence.
> Code Value	(0008,0100)	3	
> Code Scheme Designator	(0008,0102)	3	Always set to "SNM3"
> Code Meaning	(0008,0104)	3	

**Table 4-15 DX POSITIONING MODULE ATTRIBUTES**

>View Modifier Code Sequence	(0054,0222)	3	
Patient Orientation Code Sequence	(0054,0410)	3	One item is sent in this sequence.
> Code Value	(0008,0100)	3	
> Code Scheme Designator	(0008,0102)	3	Always set to "SNM3"
> Code Meaning	(0008,0104)	3	
>Patient Orientation Modifier Code Sequence	(0054,0412)	3	One item is sent in this sequence.
>> Code Value	(0008,0100)	3	
>> Code Scheme Designator	(0008,0102)	3	Always set to "SNM3"
>> Code Meaning	(0008,0104)	3	
Patient Gantry Relationship Code Sequence	(0054,0414)	3	Sequence that describes the orientation of the patient with respect to the gantry.
> Code value	(0008,0100)	1C	The code value that represents the patient orientation with respect to the gantry.
> Coding Scheme Designator	(0008,0102)	1C	SNM3
> Code Meaning	(0008,0104)	3	The patient gantry relationship that is represented by the code value. R-10516 = Oblique F-10470 = Head-first F-10480 = Feet-first R-10515 = Transverse
Distance Source to Patient	(0018,1111)	3	Distance Source to Patient Barrier. Not present in Tomo Slice images
Distance Source to Detector	(0018,1110)	3	Distance Source to Image Distance. Not present in Tomo Slice images.
Positioner Type	(0018,1508)	2	Set to zero length value.

**Table 4-15 DX POSITIONING MODULE ATTRIBUTES**

#### 4.5.5.8 X-ray Acquisition Dose Modules

This section specifies the Attributes that describe the acquisition parameters used when acquiring the image.

Attribute Name	Tag	Type	Attribute Description
KVP	(0018,0060)	3	Not present in Dual Energy Soft Tissue and Bone FOR PRESENTATION Images. Also not present in FOR PRESENTATION images created by pasting other images. Not present in Tomosynthesis Slice images- FOR PRESENTATION
Distance Source to Detector	(0018,1110)	3	Distance Source to Image Distance. Not present in FOR PRESENTATION images created by pasting other images. Not present in Tomosynthesis Slice images- FOR PRESENTATION
Distance Source to Patient	(0018,1111)	3	Distance Source to Patient Barrier. Not present in FOR PRESENTATION images created by pasting other images. Not present in Tomosynthesis Slice images- FOR PRESENTATION

**Table 4-16 X-RAY ACQUISITION DOSE MODULE ATTRIBUTES**

Image Area Dose Product	(0018,115E)	3	Set to Calculated Dose Area Product in dGy*cm2 Not present in Dual Energy Soft Tissue and Bone FOR PRESENTATION Images. Also not present in FOR PRESENTATION images created by pasting other images. Not present in Tomosynthesis Slice images- FOR PRESENTATION
Exposure Time	(0018,1150)	3	Unit: ms Not present in Dual Energy Soft Tissue and Bone FOR PRESENTATION Images. Also not present in FOR PRESENTATION images created by pasting other images. Not present in Tomosynthesis Slice images- FOR PRESENTATION
X-ray Tube Current	(0018,1151)	3	Unit: mA Not present in Dual Energy Soft Tissue and Bone FOR PRESENTATION Images. Also not present in FOR PRESENTATION images created by pasting other images. Not present in Tomosynthesis Slice images- FOR PRESENTATION
Exposure	(0018,1152)	3	Unit: mAs Not present in Dual Energy Soft Tissue and Bone FOR PRESENTATION Images. Also not present in FOR PRESENTATION images created by pasting other images. Not present in Tomosynthesis Slice images- FOR PRESENTATION
Exposure in uAs	(0018,1153)	3	Unit: microAs Not present in Dual Energy Soft Tissue and Bone FOR PRESENTATION Images. Also not present in FOR PRESENTATION images created by pasting other images. Not present in Tomosynthesis Slice images- FOR PRESENTATION
Relative X-ray Exposure	(0018,1405)	3	Set to Calculated Patient Entrance Dose in uGy Not present in Dual Energy Soft Tissue and Bone FOR PRESENTATION Images. Also not present in FOR PRESENTATION images created by pasting other images. Not present in Tomosynthesis Slice images- FOR PRESENTATION.
Filter Material	(0018,7050)	3	Always set to COPPER
Filter Thickness Minimum	(0018,7052)	3	Enumerated Values: 0.1 0.2 0.3
Filter Thickness Maximum	(0018,7054)	3	Enumerated Values: 0.1 0.2 0.3
Entrance Dose	(0040,0302)	3	Not present in Tomosynthesis images
Comments on Radiation Dose	(0040,0310)	3	Set to Customer Dose Adjustment in %.

Table 4-16 X-RAY ACQUISITION DOSE MODULE ATTRIBUTES

### 4.5.5.9 X-ray Generation Module

This section specifies the Attributes that describe the X-ray generation when acquiring the image.

Attribute Name	Tag	Type	Attribute Description
KVP	(0018,0060)	3	Not present in Dual Energy Soft Tissue and Bone FOR PRESENTATION Images. Also not present in FOR PRESENTATION images created by pasting other images. Not present in Tomosynthesis Slice images- FOR PRESENTATION
X-ray Tube Current	(0018,1151)	3	Unit: mA Not present in Dual Energy Soft Tissue and Bone FOR PRESENTATION Images. Also not present in FOR PRESENTATION images created by pasting other images. Not present in Tomosynthesis Slice images- FOR PRESENTATION
Exposure Time	(0018,1150)	3	Sent in X-ray Acquisition Dose Module Unit: ms Not present in Dual Energy Soft Tissue and Bone FOR PRESENTATION Images. Also not present in FOR PRESENTATION images created by pasting other images. Not present in Tomosynthesis Slice images- FOR PRESENTATION
Exposure	(0018,1152)	3	Unit: mAs Not present in Dual Energy Soft Tissue and Bone FOR PRESENTATION Images. Also not present in FOR PRESENTATION images created by pasting other images. Not present in Tomosynthesis Slice images- FOR PRESENTATION
Exposure in uAs	(0018,1153)	3	Unit: microAs Not present in Dual Energy Soft Tissue and Bone FOR PRESENTATION Images. Also not present in FOR PRESENTATION images created by pasting other images. Not present in Tomosynthesis Slice images- FOR PRESENTATION
Focal Spot	(0018,1190)	3	Set to 0.6 or 1.25
Exposure Control Mode	(0018,7060)	3	Defined Terms: MANUAL AUTOMATIC
Exposure Control Mode Description	(0018,7062)	3	Sent only if Exposure Control Mode is Automatic.

**Table 4-17 X-RAY GENERATION MODULE ATTRIBUTES**



**4.5.5.10 X-ray Filtration Module**

This section specifies the Attributes that describe the filtration of X-rays during the acquisition of an X-ray image.

Attribute Name	Tag	Type	Attribute Description
Filter Type	(0018,1160)	3	Enumerated Values: MULTIPLE NONE
Filter Material	(0018,7050)	3	Always set to COPPER
Filter Thickness Minimum	(0018,7052)	3	Enumerated Values: 0.1 0.2 0.3
Filter Thickness Maximum	(0018,7054)	3	Enumerated Values: 0.1 0.2 0.3

**Table 4-18 X-RAY FILTRATION MODULE ATTRIBUTES**

**4.5.5.11 X-ray Grid Module**

This section specifies the Attributes that describe the grid used during acquisition.

Attribute Name	Tag	Type	Attribute Description
Grid	(0018,1166)	3	Value 1 Enumerated Values are: FIXED NONE Value 2 Enumerated Values are: FOCUSED

**Table 4-19 X-RAY GRID MODULE ATTRIBUTES**

**4.5.5.12 Overlay Plane module:**

An Overlay Plane describes graphics or bit-mapped text that is associated with an Image or has its own existence within a Series. It may also describe a region of Interest in an Image.

Each Overlay Plane is one bit deep. Sixteen separate Overlay Planes may be associated with an Image or exist as Standalone Overlays in a Series.

Attribute Name	Tag	Type	Attribute Description
Overlay Rows	(6000,0010)	1	Number of Rows in Overlay
Overlay Columns	(6000,0011)	1	Number of Columns in Overlay.
Overlay Type	(6000,0040)	1	Indicates whether this overlay represents a region of interest or other graphics. Value = G
Overlay Subtype	(6000,0045)	3	Defined term that identifies the intended purpose of the Overlay Type. Value = USER

**Table 4-20 OVERLAY PLANE MODULE**

Overlay Origin	(6000,0050)	1	Location of first Overlay point with respect to pixels in the image given as row/column. Value = 1\1
Overlay Bits Allocated	(6000,0100)	1	Number of bits allocated in the overlay. Value = 1
Overlay Bit Position	(6000,0102)	1	Bit in which Overlay is stored. Value = 0
Overlay Data	(6000,3000)	1C	Overlay Pixel Data.

**Table 4-20 OVERLAY PLANE MODULE**

#### 4.5.5.13 VOI LUT Module

The table in this Section contains IOD Attributes that describe the VOI LUT.

Attribute Name	Tag	Type	Attribute Description
VOI LUT Sequence	(0028,3010)	3	Up to 4 items can be present in this sequence. Sequence is only present when the system is configured to generate the VOI LUT Sequence.
>LUT Explanation	(0028,3003)	3	Free form text explanation of the meaning of the LUT.
>LUT Data	(0028,3006)	1C	LUT data in this sequence. Required if the VOI LUT Sequence is sent.
Window Center	(0028,1050)	3	Sent in DX For Presentation Images. Up to four values are present in the For Presentation DX images. The fourth value is present when the operator adjusts and saves the window center during image review. The other values are defined as preset values (Normal, Harder, Softer) during acquisition.
Window Width	(0028,1051)	1C	Sent in DX For Presentation Images. Up to four values are present in the For Presentation DX images. The fourth value is present when the operator adjusts and saves the window width during image review. The other values are defined as preset values (Normal, Harder, Softer) during acquisition.
Window Center & Width Explanation	(0028,1055)	3	Sent in DX For Presentation Images. Up to four values are present.

**Table 4-21 VOI LUT MODULE ATTRIBUTES**

#### 4.5.5.14 Acquisition Context Module

The table in this Section contains IOD Attributes that describe the acquisition context while acquiring the DX image.

Attribute Name	Tag	Type	Attribute Description
Acquisition Context Sequence	(0040,0555)	2	Zero length value is sent unless it is necessary to convey concept of flexion or extension, in which case one item is sent.
>Concept-name Code Sequence	(0040,A043)	1C	One item is sent in this sequence if it is necessary as explained above.

**Table 4-22 ACQUISITION CONTEXT MODULE ATTRIBUTES**

>>Code Value	(0008,0100)	1C	
>>Coding Scheme Designator	(0008,0102)	1C	
>>Code Meaning	(0008,0104)	1C	
>Concept Code Sequence	(0040,A168)	1C	
>>Code Value	(0008,0100)	1C	
>>Coding Scheme Designator	(0008,0102)	1C	
>>Code Meaning	(0008,0104)	1C	

**Table 4-22 ACQUISITION CONTEXT MODULE ATTRIBUTES**

#### 4.5.5.15 SOP Common Module

This section defines the Attributes that are required for proper functioning and identification of the associated SOP Instances. They do not specify any semantics about the Real-World Object represented by the IOD.

Attribute Name	Tag	Type	Attribute Description
Specific Character Set	(0008,0005)	1C	Set to ISO_IR 100 = Latin Alphabet No. 1
SOP Class UID	(0008,0016)	1	
SOP Instance UID	(0008,0018)	1	

**Table 4-23 SOP COMMON MODULE ATTRIBUTES**

#### 4.5.5.16 Icon Image module

The table in this Section contains IOD Attributes that describe the icon image.

Attribute Name	Tag	Type	Attribute Description
Icon Image Sequence	(0088,0200)	3	
>Samples Per Pixel	(0028,0002)	1C	Always set to 1
>Photometric Interpretation	(0028,0004)	1C	Always set to "MONOCHROME2"
>Rows	(0028,0010)	1C	Always <= 64
>Columns	(0028,0011)	1C	Always <= 64
>BitsAllocated	(0028,0100)	1C	Always equal to 8
>BitsStored	(0028,0101)	1C	Always equal to 8
>HighBit	(0028,0102)	1C	Always equal to 7
>Pixel Representation	(0028,0103)	1C	Always equal to 0
>Pixel Data	(7FE0,0010)	1C	

**Table 4-24 ICON IMAGE MODULE ATTRIBUTES**

#### 4.5.5.17 Discovery XR656 Frame of Reference Module

This section is apply to Discovery XR656 GII and Discovery XR656 system.

The table in this Section contains IOD Attributes that describe the Frame of Reference for the Volume RAD (Tomosynthesis) acquisitions. Present only in Tomosynthesis Images

Attribute Name	Tag	Type	Attribute Description
Frame of Reference UID	(0020,0052)	1	This is present only for the Tomosynthesis images. This is generated at the acquisition/reprocessing of the 1st image and remain the same for all images related to that acquisition.

**Table 4-25 FRAME OF REFERENCE MODULE ATTRIBUTES**

Position Reference Indicator	(0020,1040)	2	Part of the patient's anatomy used as a reference, such as the iliac crest, orbital medial, sternal notch, symphysis pubis, xiphoid, lower costal margin, external auditory meatus. See C.7.4.1.1.2 for further explanation. Currently filled with Null Value.
------------------------------	-------------	---	--

**Table 4-25 FRAME OF REFERENCE MODULE ATTRIBUTES**

#### 4.5.5.18 Discovery XR656 X-ray Tomography Acquisition Module

This section is apply to Discovery XR656 GII and Discovery XR656 system.

This Module describes the attributes of a Tomography acquisition. Attributes in this section are present only for Volume RAD (Tomosynthesis) images.

Attribute Name	Tag	Type	Attribute Description
Tomo Layer Height	(0018,1460)	1	For Projection images, it equals the layer height where the Tomo sweep focal plane is defined, measured from Tabletop or Wallstand surface. For Slices it equals the slice height from detector plane.
Tomo Angle	(0018,1470)	3	Angles span in degrees of rotation for the entire tomo sweep
Tomo Time	(0018,1480)	3	Time in seconds for the full acquisitions in the tomo sweep to be complete including the ramp-up time. For Projections it is the prescribed time and for Slices it equals the actual sweep time.
Tomo Type	(0018,1490)	3	Type of tomography: LINEAR
Tomo Class	(0018,1491)	3	Form of tomography: TOMOSYNTHESIS
Number of Tomosynthesis Source Images	(0018,1495)	3	For Projections the value equals the prescribed number of exposures. For Slices, the value equals the number of exposures actually used to construct the slice.

**Table 4-26 X-RAY TOMOGRAPHY ACQUISITION MODULE ATTRIBUTES**

#### 4.5.5.19 Discovery XR656 XA Positioner Module

This section is apply to Discovery XR656 GII and Discovery XR656 system.

This module contains the attributes that define the coordinate system used to track the positioner that is defined in reference to the patient. Attributes in this section are present only for Volume RAD (Tomosynthesis) images.

Attribute Name	Tag	Type	Attribute Description
Detector Primary Angle	(0018,1530)	3	It depends on the Positioner Geometry. For a focal spot of (x,y,z), it is equal to the atan(x/z). Present only in Tomosynthesis images. Not present in Tomo Slices-FOR PRESENTATION.
Detector Secondary Angle	(0018,1531)	3	It depends on the Positioner Geometry. For a focal spot of (x,y,z), it is equal to the atan(y/z). Present only in Tomosynthesis images. Not present in Tomo Slices-FOR PRESENTATION.

**Table 4-27 XA POSITIONER MODULE ATTRIBUTES**

#### 4.5.5.20 Discovery XR656 Image Plane Module

This section is apply to Discovery XR656 GII and Discovery XR656 system.

Attribute Name	Tag	Type	Attribute Description
Slice Thickness	(0018,0050)	2	Nominal Slice thickness in mm. The value could be empty. Present in Tomosynthesis – FOR PRESENTATION images only

**Table 4-28 IMAGE PLANE MODULE ATTRIBUTES**

Pixel Spacing	(0028,0030)	1	Present in Tomosynthesis – FOR PRESENTATION images only
Slice Location	(0020,1041)	3	Present in Tomosynthesis – FOR PRESENTATION images only. Equivalent to image layer height.

**Table 4-28 IMAGE PLANE MODULE ATTRIBUTES**

### 4.5.6 Application Module (Private Module)

Application Module is a private module.

The table in this Section contains Attributes that describe various information required by the Acquisition Workstation Medical Application.

#### 4.5.6.1 Discovery XR656 GII and Discovery XR656 Application Module Table

Attribute Name	Tag	Type	Attribute Description
Private Creator	(0011,0010)	1	GEMS_GDXE_FALCON_04
Processed Series UID	(0011,1003)	3	Processed Series UID
Acquisition Type	(0011,1004)	3	Acquisition Type
Acquisition UID	(0011,1005)	3	Acquisition UID
Image Dose	(0011,1006)	3	Image Dose. Not present in Tomosynthesis Slice images – For Presentation
Non-Digital Exposures	(0011,1009)	3	Non-Digital Exposures
Total Exposures	(0011,1010)	3	Total Exposures
ROI	(0011,1011)	3	ROI
Patient Size String	(0011,1012)	3	Patient Size String
SPS UID	(0011,1013)	3	SPS UID
Detector ARC Gain	(0011,1015)	3	Detector ARC Gain
Processing Debug Info	(0011,1016)	3	Processing Debug Info
Override mode	(0011,1017)	3	DISABLE/ENABLE
Film Speed Selection	(0011,1019)	3	Film Speed Selection
Detected Field of View	(0011,1031)	3	Actual collimator FOV
Adjusted Field of View	(0011,1032)	3	Output of ICED algorithm Value from user manual adjustment. <b>Note:</b> When the collimator is rotated, the stored vertices are those of the rectangle circumscribing the polygonal collimator.
Detected Exposure Index	(0011,1033)	3	Detected Exposure Index
Compensated Detector Exposure	(0011,1034)	3	Compensated Detector Exposure
Uncompensated Detector Exposure	(0011,1035)	3	Uncompensated Detector Exposure
Median Anatomy Count Value	(0011,1036)	3	Median Anatomy count value
DEI lower and upper limit values	(0011,1037)	3	DEI lower and upper limit values
Shift Vector for Pasting	(0011,1038)	3	Present only in pasted images.

**Table 4-29 APPLICATION MODULE PRIVATE ATTRIBUTES**

Attribute Name	Tag	Type	Attribute Description
Image Number for Pasting	(0011,1039)	3	In sub-images indicates the sub-image number (1/3, 2/3, etc). In Pasted image is equal to the number of sub-images used for pasting. In Tomo indicates the instance number of the total images in the series (2/60).
Pasting Overlap	(0011,1040)	3	Amount of overlap. Only in pasted image.
Sub-image collimator Vertices	(0011,1041)	3	Only in pasted image. Collimator vertices of the subimages.
View IP	(0011,1042)	3	View prescribed
Key Stone Co-ordinates	(0011,1043)	3	Only in pasted image. Co-ordinates of the keystone used for cropping the image.
Receptor Type	(0011,1044)	3	Table or WallStand
Conversion Factor	(0011,1047)	3	Calibration for a specified detector
Focal Spot Positions (x,y,z)	(0011,1048)	3	Present only in Tomosynthesis Projection Images
Frame Rate	(0011,1051)	3	Present only in Tomosynthesis Projection and Slice images
Tube to Detector Angle	(0011,1052)	3	Present only in Tomosynthesis Projection Images
OTS Column Rotation Angle	(0011,1053)	3	Present only in Tomosynthesis Projection Images
Start Height	(0011,1054)	3	Present in Tomosynthesis Projection and Slice images. These are the Recon parameters in mm
End Height	(0011,1055)	3	Present in Tomosynthesis Projection and Slice images. These are the Recon parameters in mm
Sampling Factor	(0011,1056)	3	Present in Tomosynthesis Projection and Slice images.
Sweep Direction	(0011,1057)	3	Present in Tomosynthesis Projection and Slice images.
Slice Interval	(0011,1058)	3	Present in Tomosynthesis Projection and Slice images. These are the Recon parameters in mm
Grid Position	(0011,1059)	3	Determines the orientation of the Grid
Wallstand Position	(0011,1060)	3	Position of Wallstand housing
RRA Classification	(0011,1062)	3	Only present if RRA is enabled. Only present in Presentation Images. RRA classification for repeat acquisitions, for unnecessary images for non-clinical images is filled in this tag.
RRA Reason	(0011,1063)	3	Only present if RRA is enabled. Only present in Presentation Images. Values consists of reason for repeat acquisition.
Detector Type	(0011,1064)	3	Type of detector used during exposure
Derived Receptor Type	(0011,1065)	3	Type of receptor used during exposure, applicable to the HW configuration of Discovery XR656. Not present in Digital Cassette images.
Extension Cable In Use	(0011,1066)	3	Indicates if the extension cable was in use

Attribute Name	Tag	Type	Attribute Description
Detector Port In Use	(0011,1067)	3	Table port in use
Mac Address	(0011,1068)	3	Detector Mac Address
Detector Height Correction	(0011,1069)	3	Distance from Detector to the Table/WS patient barrier. This tag is only used for the Tomo Recon feature.
Default Normal LUT	(0011,106B)	3	LUT for JEG conversion. Only present in Presentation Images.

Uncompensated Sensitivity	(0011,106D)	3	Is defined as the conversion efficiency of the detector
EMI Applied	(0011,1070)	3	EMI applied or not
EMI Configuration	(0011,1071)	3	EMI configuration parameters
EMI Correction Data	(0011,1072)	3	Data of frequency, amplitude and Phase of the detected signals
Deviation Index	(0011, 1073)	3	Deviation Index behind patient anatomy
Exposure Index	(0011, 1074 )	3	Exposure Index behind patient anatomy.
Target Exposure Index	(0011, 1075)	3	Target Exposure Index behind patient anatomy.
Patient Orientation Original Value	(0011, 1076)	3	Patient Orientation Original Value
Fast Preview Quantifications Sufficient Value	(0011, 1077)	3	Fast Preview Quantifications Sufficient Value
Fast Preview Final Min Value	(0011, 1078)	3	Fast Preview Final Min Value
Fast Preview Final Max Value	(0011, 1079)	3	Fast Preview Final Max Value
Fast Preview R1 Value	(0011, 107A)	3	Fast Preview R1 Value
Fast Preview R2 Value	(0011, 107B)	3	Fast Preview R2 Value
Fast Preview Sign Changed	(0011, 107C)	3	Fast Preview Sign Changed
GridLine Artifact Applied	(0011,107D)	3	GridLine Artifact Applied or not
Detector Orientation	(0011, 107E)	3	Detector Orientation
View Name for DX Image	(0011, 1081)	3	View Name for DX Image
Private Creator	(0045,0010)	1	GEMS_FALCON_03
A_Coefficients	(0045,1055)	3	Used in Multi-resolution Algorithm
User Window Center	(0045,1062)	3	User Window Center
User Window Width	(0045,1063)	3	User Window Width
Requested Detector Entrance Dose	(0045,1065)	3	Requested detector entrance dose in units of nanoGray.
VOI LUT Asymmetry parameter beta	(0045,1067)	3	Used for calculating Asymmetric LUT
Collimator rotation	(0045,1069)	3	0: No collimator rotation; 1: Collimator Rotation
Private Creator	(7FDF,0010)	1	GEMS_GDXE_ATHENAV2_INTERNAL_USE
PPS Stream	(7FDF,1010)	3	Pixel Data References
Auto Push Tag	(7FDF,1020)	3	Auto Push Tag
PPS Status	(7FDF,1025)	3	PPS Status

4.5.6.2 Optima XR646 and Definium 6000 Application Module Table

Attribute Name	Tag	Type	Attribute Description
Private Creator	(0045,0010)	1	GEMS_SEND_02
A_Coefficients	(0045,1055)	3	Used in Multi-resolution Algorithm
User Window Center	(0045,1062)	3	User Window Center
User Window Width	(0045,1063)	3	User Window Width
Requested Detector Entrance Dose	(0045,1065)	3	Requested detector entrance dose in units of nanoGray.

Table 4-30 APPLICATION MODULE PRIVATE ATTRIBUTES

VOI LUT Asymmetry parameter beta	(0045,1067)	3	Used for calculating Asymmetric LUT
Collimator rotation	(0045,1069)	3	0: No collimator rotation; 1: Collimator Rotation
Collimator Width	(0045,1072)	3	Collimator FOV width in mm
Collimator Height	(0045,1073)	3	Collimator FOV height in mm
Private Creator	(0011,0010)	1	GEMS_FALCON_04
Processed Series UID	(0011,1003)	3	Processed Series UID
Acquisition Type	(0011,1004)	3	Acquisition Type
Acquisition UID	(0011,1005)	3	Acquisition UID
Image Dose	(0011,1006)	3	Image Dose.
Study Dose	(0011,1007)	3	Study Dose
Study DAP	(0011,1008)	3	Study DAP
Non-Digital Exposures	(0011,1009)	3	Non-Digital Exposures
Total Exposures	(0011,1010)	3	Total Exposures
ROI	(0011,1011)	3	ROI
Patient Size String	(0011,1012)	3	Patient Size String
SPS UID	(0011,1013)	3	SPS UID
Detector ARC Gain	(0011,1015)	3	Detector ARC Gain
Processing Debug Info	(0011,1016)	3	Processing Debug Info
Override mode	(0011,1017)	3	DISABLE/ENABLE
Film Speed Selection	(0011,1019)	3	Film Speed Selection
Private Creator	(7FDF,0010)	1	GEMS_GDXE_ATHENAV2_INTERNAL_USE
PPS Stream	(7FDF,1010)	3	Pixel Data References
Auto Push Tag	(7FDF,1020)	3	Auto Push Tag
PPS Status	(7FDF,1025)	3	PPS Status

**Table 4-30 APPLICATION MODULE PRIVATE ATTRIBUTES**

## 4.6 PRIVATE DATA DICTIONARY

The table in this section describes the Private Attributes contained in DX images.

### 4.6.1 Discovery XR656 GII and Discovery XR656 Private Attributes Table

Attribute Name	Tag	VR	VM
Private Creator	(0011,0010)	LO	1
Processed Series UID	(0011,1003)	UI	1
Acquisition Type	(0011,1004)	CS	1
Acquisition UID	(0011,1005)	UI	1
Image Dose	(0011,1006)	DS	1
Non-Digital Exposures	(0011,1009)	SL	1
Total Exposures	(0011,1010)	SL	1
ROI	(0011,1011)	LT	1
Patient Size String	(0011,1012)	LT	1
SPS UID	(0011,1013)	UI	1

**Table 4-31 PRIVATE CREATOR IDENTIFICATION (GEMS\_FALCON\_03)**



Attribute Name	Tag	VR	VM
Detector ARC Gain	(0011,1015)	DS	1
Processing Debug Info	(0011,1016)	LT	1
Override mode	(0011,1017)	CS	1
Film Speed Selection	(0011,1019)	DS	1
Detected Field of View	(0011,1031)	IS	8
Adjusted Field of View	(0011,1032)	IS	8
Detected Exposure Index	(0011,1033)	DS	1
Compensated Detector Exposure	(0011,1034)	DS	1
Uncompensated Detector Exposure	(0011,1035)	DS	1
Median Anatomy Count Value	(0011,1036)	DS	1
DEI lower and upper limit values	(0011,1037)	DS	2
Shift Vector for Pasting	(0011,1038)	SL	6
Image Number in Pasting	(0011,1039)	CS	1
Pasting Overlap	(0011,1040)	SL	1
Sub-image Collimator Vertices	(0011,1041)	IS	24
View IP	(0011,1042)	LO	1
Key-stone Co-ordinates	(0011,1043)	IS	24
Receptor Type	(0011,1044)	CS	1
Conversion Factor	(0011,1047)	DS	1
Grid Position	(0011,1059)	CS	1
Wallstand Position	(0011,1060)	CS	1
RRA Classification	(0011,1062)	LO	1
RRA Reason	(0011,1063)	US	1
Detector Type	(0011,1064)	CS	1
Derived Receptor Type	(0011,1065)	LO	1
Extension Cable In Use	(0011,1066)	SH	1
Detector Port In Use	(0011,1067)	SH	1
Mac Address	(0011,1068)	LO	1
Detector Height Correction	(0011,1069)	DS	1
Default Normal LUT	(0011,106B)	CS	n
Uncompensated Sensitivity	(0011,106D)	DS	1
EMI Applied	(0011,1070)	CS	1
EMI Configuration	(0011,1071)	DS	1
EMI Correction Data	(0011,1072)	SS	1
Deviation Index	(0011, 1073)	DS	1
Exposure Index	(0011, 1074)	DS	1
Target Exposure Index	(0011, 1075)	DS	1
Patient Orientation Original Value	(0011, 1076)	CS	2
Fast Preview Quantifications Sufficient Value	(0011, 1077)	CS	1
Fast Preview Final Min Value	(0011, 1078)	DS	1
Fast Preview Final Max Value	(0011, 1079)	DS	1
Fast Preview R1 Value	(0011, 107A)	SS	1
Fast Preview R2 Value	(0011, 107B)	SS	1
Fast Preview Sign Changed	(0011, 107C)	CS	1
GridLine Artifact Applied	(0011,107D)	CS	1
Detector Orientation	(0011, 107E)	DS	1

Table 4-31 PRIVATE CREATOR IDENTIFICATION (GEMS\_FALCON\_03)

Attribute Name	Tag	VR	VM
View Name for DX Image	(0011, 1081)	LO	1
Private Creator	(0045,0010)	LO	1
A_Coefficients	(0045,1055)	DS	8
User Window Center	(0045,1062)	IS	1
User Window Width	(0045,1063)	IS	1
Requested Detector Entrance Dose	(0045,1065)	IS	1
VOI LUT Asymmetry parameter beta	(0045,1067)	DS	3
Collimator rotation	(0045,1069)	IS	1
Collimator Width	(0045,1072)	DS	1
Collimator Height	(0045,1073)	DS	1
Private Creator	(7fdf, 0010)	LO	1
PPS Stream	(7fdf, 1010)	LT	1
Auto Push Tag	(7fdf, 1020)	SS	1
PPS Status	(7fdf, 1025)	CS	1

**Table 4-31 PRIVATE CREATOR IDENTIFICATION (GEMS\_FALCON\_03)**

#### 4.6.2 Optima XR646 and Definium 6000 Private Attributes Table

Attribute Name	Tag	VR	VM
Private Creator	(0011,0010)	LO	1
Processed Series UID	(0011,1003)	UI	1
Acquisition Type	(0011,1004)	CS	1
Acquisition UID	(0011,1005)	UI	1
Image Dose	(0011,1006)	DS	1
Study Dose	(0011,1007)	FL	1
Study DAP	(0011,1008)	FL	1
Non-Digital Exposures	(0011,1009)	SL	1
Total Exposures	(0011,1010)	SL	1
ROI	(0011,1011)	LT	1
Patient Size String	(0011,1012)	LT	1
SPS UID	(0011,1013)	UI	1
Detector ARC Gain	(0011,1015)	DS	1
Processing Debug Info	(0011,1016)	LT	1
Override Mode	(0011,1017)	CS	1
Film Speed Selection	(0011,1019)	DS	1
Private Creator	(0045,0010)	LO	1
A_Coefficients	(0045,1055)	DS	8
User Window Center	(0045,1062)	IS	1
User Window Width	(0045,1063)	IS	1
Requested Detector Entrance Dose	(0045,1065)	IS	1
VOI LUT Asymmetry parameter beta	(0045,1067)	DS	3
Collimator rotation	(0045,1069)	IS	1
Collimator Width	(0045,1072)	DS	1
Collimator Height	(0045,1073)	DS	1

**Table 4-32 PRIVATE CREATOR IDENTIFICATION (GEMS\_FALCON\_03)**

Attribute Name	Tag	VR	VM
Private Creator	(7fdf, 0010)	LO	1
PPS Stream	(7fdf, 1010)	LT	1
Auto Push Tag	(7fdf, 1020)	SS	1
PPS Status	(7fdf, 1025)	CS	1

**Table 4-32 PRIVATE CREATOR IDENTIFICATION (GEMS\_FALCON\_03)**

## Section 5.0 STUDY ROOT QUERY/RETRIEVE INFORMATION MODEL DEFINITION

### 5.1 INTRODUCTION

This section specifies the use of the DICOM Study Root Query/Retrieve Model used to organize data and against which a Query/Retrieve will be performed. The contents of this section are:

- 5.2 - Information Model Description
- 5.3 - Information Model Entity-Relationship Model
- 5.4 - Information Model Keys

### 5.2 STUDY ROOT INFORMATION MODEL DESCRIPTION

### 5.3 STUDY ROOT INFORMATION MODEL ENTITY-RELATIONSHIP MODEL

The Entity-Relationship diagram for the Study Root Information Model schema is shown in Illustration 5-1. In this figure, the following diagrammatic convention is established to represent the information organization:

- each entity is represented by a rectangular box
- each relationship is represented by a diamond shaped box.
- the fact that a relationship exists between two entities is depicted by lines connecting the corresponding entity boxes to the relationship boxes.

The relationships are fully defined with the maximum number of possible entities in the relationship shown. In other words, the relationship between Series and Image can have up to n Images per Series.

#### ILLUSTRATION 5-1

#### STUDY ROOT QUERY/RETRIEVE INFORMATION MODEL E/R DIAGRAM

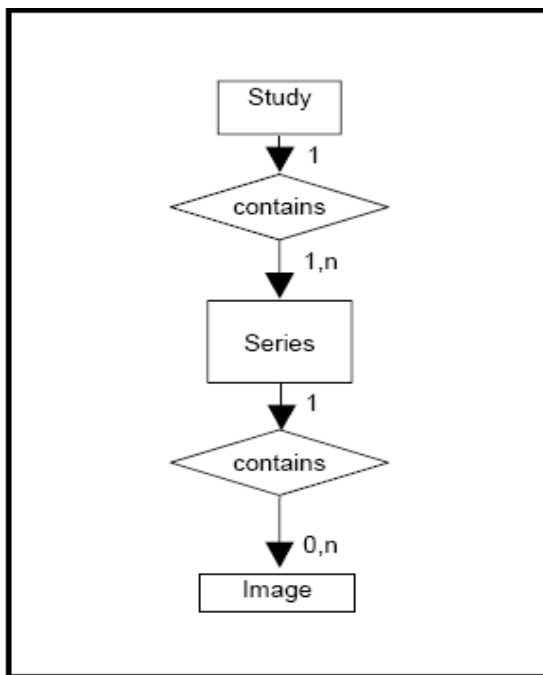

### 5.3.1 Entity Descriptions

Please refer to DICOM Standard PS 3.4 (Service Class Specifications) for a description of each of the levels contained within the Study Root Query/Retrieve Information Model.

### 5.3.2 Acquisition Workstation Mapping of DICOM entities

DICOM	Acquisition Workstation Entity
Study	Study
Series	Series
Image	Image

**Table 5-1 MAPPING OF DICOM ENTITIES TO ACQUISITION WORKSTATION ENTITIES**

## 5.4 INFORMATION MODEL KEYS

Please refer to DICOM Standard PS 3.4 (Service Class Specifications) for a description of each of the levels contained within the Study Root Query/Retrieve Information Model.

The following Level descriptions are included to specify what data elements are supported and what type of matching can be applied. It should be noted that they are the same ones as defined in the DICOM V3.0 Standard PS 3.4 (Service Class Specifications).

### 5.4.1 Supported Matching

Following are the types of matching that can be requested by the implementation:

- Single Value matching
- Universal Matching
- Wild Card Matching
- Range of date, Range of Time

### 5.4.2 Study Level

This section defines the keys at the Study Level of the Study Root Query/Retrieve Information Model that are supported by this implementation.

Attribute Name	Tag	Type	Attribute Description
Study Date	(0008,0020)	R	User Filtering is possible
Study Time	(0008,0030)	R	User Filtering is possible
Accession Number	(0008,0050)	R	
Patient's Name	(0010,0010)	R	User Filtering is possible
Patient ID	(0010,0020)	U	User Filtering is possible
Study Instance UID	(0020,000D)	U	
Study ID	(0020,0010)	R	
Study Description	(0008,0930)	U	User Filtering is possible

**Table 5-2 STUDY LEVEL ATTRIBUTES FOR THE STUDY ROOT QUERY/RETRIEVE INFORMATION MODEL**

Attribute Name	Tag	Type	Note
Query Retrieve Level	(0008,0052)	-	Value = STUDY

**Table 5-3 Q/R STUDY LEVEL AND LOCATION FOR RETRIEVE ATTRIBUTES**

### 5.4.3 Series Level

This section defines the keys at the Series Level of the Study Root Query/Retrieve Information Model that are supported by this implementation.

Attribute Name	Tag	Type	Attribute Description
Modality	(0008,0060)	R	
Series Instance UID	(0020,000E)	U	
Series Number	(0020,0011)	R	
Series Description	(0008,103E)	O	User Filtering is possible

**Table 5-4 SERIES LEVEL ATTRIBUTES FOR THE STUDY ROOT QUERY/RETRIEVE INFORMATION MODEL**

Attribute Name	Tag	Type	Note
Query Retrieve Level	(0008,0052)	-	Value = SERIES

**Table 5-5 Q/R SERIES LEVEL AND LOCATION FOR RETRIEVE ATTRIBUTES**

### 5.4.4 Image Level

This section defines the keys at the Image Level of the Study Root Query/Retrieve Information Model that are supported by this implementation.

Attribute Name	Tag	Type	Attribute Description
SOP Instance UID	(0008,0018)	U	
Image Number	(0020,0013)	R	

**Table 5-6 IMAGE LEVEL ATTRIBUTES FOR THE STUDY ROOT QUERY/RETRIEVE INFORMATION MODEL**

Attribute Name	Tag	Type	Note
Query Retrieve Level	(008,0052)	-	Value = IMAGE

**Table 5-7 Q/R IMAGE LEVEL AND LOCATION FOR RETRIEVE ATTRIBUTES**

## 5.5 PRIVATE DATA DICTIONARY

No private data dictionary is defined.

## Section 6.0 MODALITY WORKLIST INFORMATION MODEL DEFINITION

### 6.1 INTRODUCTION

This section specifies the use of the DICOM Modality Worklist Information Model used to organize data and against which a Modality Worklist Query will be performed. The contents of this section are:

6.2 - Information Model Description

6.3 - Information Model Entity-Relationship Model

6.4 - Information Model Module Table

6.5 - Information Model Keys

### 6.2 MODALITY WORKLIST INFORMATION MODEL DESCRIPTION

In order to serve as a Service Class Provider (SCP) of the Modality Worklist Service Class, a DICOM Application Entity (AE) possesses information about the attributes of a number of managed worklist items. These items are organized into Modality Worklist Information Modules. In this Service Class, the Information Model plays a role similar to an Information Object Definition of most other DICOM Service Classes.

### 6.3 MODALITY WORKLIST INFORMATION MODEL ENTITY-RELATIONSHIP MODEL

The Entity-Relationship diagram for the Modality Worklist Information Model schema is shown in Illustration 6-1. It represents the information that composes a Worklist Item. In this figure, the following diagrammatic convention is established to represent the information organization:

- each entity is represented by a rectangular box
- each relationship is represented by a diamond shaped box.
- the fact that a relationship exists between two entities is depicted by lines connecting the corresponding entity boxes to the relationship boxes.

#### ILLUSTRATION 6-1

#### MODALITY WORKLIST INFORMATION MODEL E/R DIAGRAM

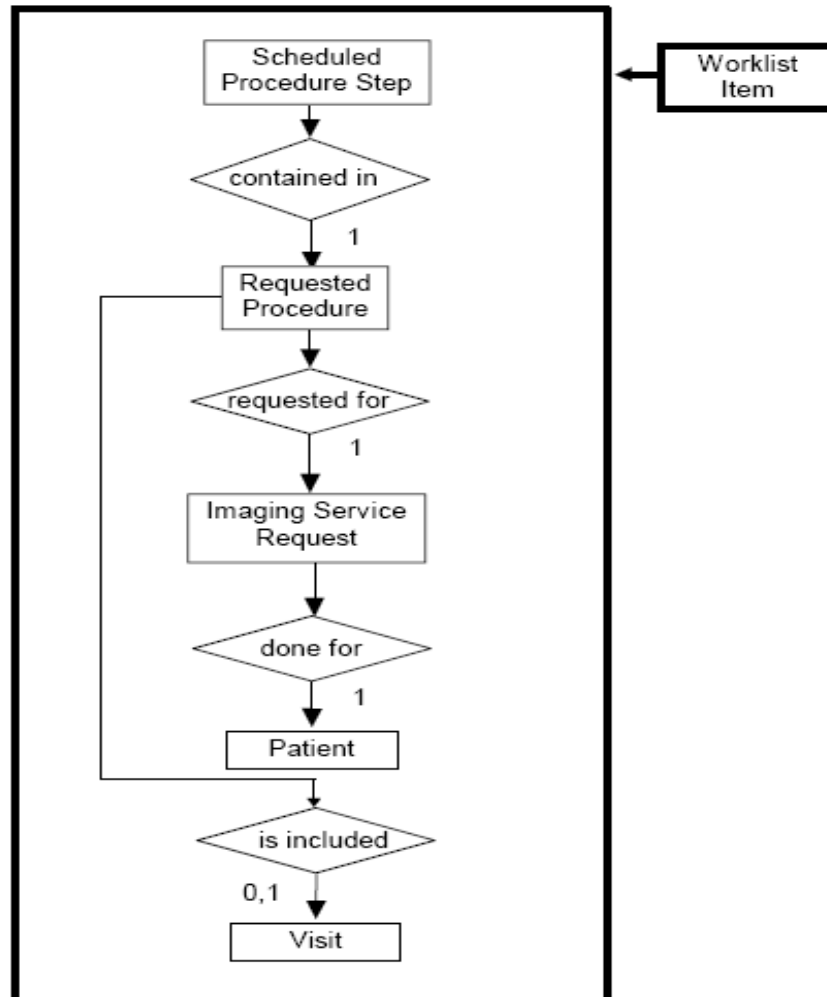

### 6.3.1 Entity Descriptions

Please refer to DICOM Standard PS 3.3. (Information Object Definitions) and PS 3.4 (Service Class Specifications) for a description of each of the Entities contained within the Modality Worklist Information Model.

#### 6.3.1.1 Scheduled Procedure Step

A Scheduled Procedure Step is an arbitrarily defined scheduled unit of service that is specified by the Procedure Plan for a Requested Procedure. It specifies one or more Action Items (events) involving equipment (i.e. imaging modality equipment), human resources, location and time (i.e. start time, stop time, duration).

#### 6.3.1.2 Requested Procedure Entity Description

A Requested Procedure is an instance of a Procedure of a given Procedure Type. An instance of a Requested Procedure includes all of the items of information that are specified by an instance of a Procedure Plan that is selected for the Requested Procedure by the imaging service provider.



**6.3.1.3 Imaging Service Request Entity Description**

An Imaging Service Request is a set of one or more Requested Procedures selected from a list of Procedure Types. An Imaging Service Request is submitted by one authorized imaging service requester to one authorized imaging service provider in the context of one Service Episode.

**6.3.1.4 Visit Entity Description**

A Visit is the context in which the treatment or management of an arbitrary subset of a Patient's medical conditions occurs. A Visit is limited to the description of a Patient's activities at a single facility.

**6.3.1.5 Patient Entity Description**

A Patient is a person receiving, or registered to receive, healthcare services.

**6.3.2 Acquisition Workstation Mapping of DICOM entities**

DICOM	Acquisition Workstation Entity
Scheduled Procedure Step	Series
Requested Procedure	Study / Exam
Imaging Service Request	Study / Exam
Visit	Study / Exam
Patient	Patient

**Table 6-1 MAPPING OF DICOM ENTITIES TO ACQUISITION WORKSTATION ENTITIES**

**6.4 INFORMATION MODEL MODULE TABLE**

Within an entity of the DICOM V3.0 Modality Worklist Information Model, attributes are grouped into related set of attributes. A set of related attributes is termed a module. A module facilitates the understanding of the semantics concerning the attributes and how the attributes are related with each other. A module grouping does not infer any encoding of information into datasets.

Table 6-2 identifies the defined modules within the entities that comprise the DICOM V3.0 Modality Worklist Information Model. Modules are identified by Module Name.

See DICOM V3.0 PS 3.3 and PS 3.4 for a complete definition of the entities, modules, and attributes.

Entity Name	Module Name	Reference
Scheduled Procedure Step	SOP Common	6.5.2.1
	Scheduled Procedure Step	6.5.2.2
	Requested Procedure	6.5.3.1
	Imaging Service Request	6.5.4.1
Visit	Visit Identification	6.5.5.1
	Visit Status	6.5.5.2
	Visit Relationship	6.5.5.3
	Visit Admission	6.5.5.4
Patient	Patient Relationship	6.5.6.1
	Patient Identification	6.5.6.2
	Patient Demographic	6.5.6.3
	Patient Medical	6.5.6.4

**Table 6-2 MODALITY WORKLIST INFORMATION MODEL MODULES**

## 6.5 INFORMATION MODEL KEYS

Please refer to DICOM Standard PS 3.3. (Information Object Definitions) and PS 3.4 (Service Class Specifications) for a description of each of the Entities contained within the Modality Worklist Information Model.

The following Module descriptions are included to specify what data elements are supported and what type of matching can be applied. It should be noted that they are the same ones as defined in the DICOM V3.0 Standard PS 3.4 (Service Class Specifications) and include:

- Name
- Tag group and element numbers
- Expected Matching Key Type: R-required, O-optional
- Expected Return Key Type:
  - 1 - non-zero value required
  - 1C - conditionally of type 1
  - 2 - required to be present, possibly with zero-length value
  - 2C - conditionally of type 2
  - 3 - optional
- Mapped into The Image - whether this data is mapped into subsequently acquired images
- Notes - clarification of this implementation's use/treatment of this attribute

All data elements in the following Module descriptions are requested by default by the Worklist Server AE.

Data elements for which values can be sent for matching purposes are described as such. Data elements for which values are not sent are sent with zero length and universal matching will apply. This is the default case if no other description to the contrary is provided.

### 6.5.1 Supported Matching

Following are the types of matching that can be request by the implementation:

- Single Value matching
- Universal Matching
- Range of date, Range of Time

### 6.5.2 Scheduled Procedure Step Entity

#### 6.5.2.1 SOP Common Module

Attribute Name	Tag	Expected Matching Key Type	Expected Returned Key Type	Mapped into the Image	Displayed to User	Updateable by User	Note
Specific Character Set	(0008,0005)	O	1C	No	No	No	Matching is supported, the matching value is "ISO_IR100" and it is not dynamically configurable.

Table 6-3 SOP COMMON MODULE ATTRIBUTES

6.5.2.2 Scheduled Procedure Step Module

Attribute Name	Tag	Expected Matching Key Type	Expected Returned Key Type	Mapped into the Image	Displayed to User	Updatable by User	Note
Scheduled Procedure Step Sequence	(0040,0100)	R	1	No	N/A	N/A	
>Scheduled Station AE Title	(0040,0001)	R	1	No	No	No	Matching is supported as follows: either no AE title is supplied (universal matching), or the Query AE title (See <b>Note</b> ) is supplied for matching; this is user selectable.
>Scheduled Procedure Step Start Date	(0040,0002)	R	1	No	Yes	No	Matching is supported as one of the following; this is user selectable: <ul style="list-style-type: none"> <li>• today only,</li> <li>• tomorrow only,</li> <li>• from date1 to date2, date1 and date2 being defined by user</li> </ul> Returned values must be exactly 8 numeric characters, in YYYYMMDD or YYYY.MM.DD format
>Modality	(0008,0060)	R	1	Yes	Yes	No	Matching is supported as follows: either no Modality is supplied (universal matching), or the system's Modality is supplied (i.e. DX) for matching; this is user selectable.
>Scheduled Performing Physician's Name	(0040,0006)	R	2	Yes	Yes	Yes	

Table 6-4 SCHEDULED PROCEDURE STEP MODULE ATTRIBUTES

>Scheduled Procedure Step Description	(0040,0007)	O	1C	Yes	Yes	Yes If not provided by HIS	
>Scheduled Action Item Code Sequence	(0040,0008)	O	1C	No	No	No	
>>Code Value	(0008,0100)	O	1C	No	No	No	
>>Coding Scheme Designator	(0008,0102)	O	1C	No	No	No	
>>Code Meaning	(0008,0104)	O	3	No	No	No	
>Scheduled Procedure Step ID	(0040,0009)	O	1	No	No	No	

Table 6-4 SCHEDULED PROCEDURE STEP MODULE ATTRIBUTES

### 6.5.3 Requested Procedure Entity

#### 6.5.3.1 Requested Procedure Module

Attribute Name	Tag	Expected Matching Key Type	Expected Returned Key Type	Mapped into the Image	Displayed to User	Updatable by User	Note
Requested Procedure ID	(0040,1001)	O	1	Yes	Yes	No	
Requested Procedure Description	(0032,1060)	O	1C	Yes	Yes	Yes If not provided by HIS	
Requested Procedure Code Sequence	(0032,1064)	O	1C	Yes	No	No	
>Code Value	(0008,0100)	O	1C	Yes	No	No	
>Coding Scheme Designator	(0008,0102)	O	1C	Yes	No	No	
>Code Meaning	(0008,0104)	O	3	Yes	No	No	
Study Instance UID	(0020,000D)	O	1	Yes	No	No	
Referenced Study Sequence	(0008,1110)	O	2	Yes	No	No	
>Referenced SOP Class UID	(0008,1150)	O	1C	Yes	No	No	

Table 6-5 REQUESTED PROCEDURE MODULE ATTRIBUTES

>Referenced SOP Instance UID	(0008,1155)	O	1C	Yes	No	No	
------------------------------	-------------	---	----	-----	----	----	--

Table 6-5 REQUESTED PROCEDURE MODULE ATTRIBUTES

### 6.5.4 Imaging Service Request Entity

#### 6.5.4.1 Imaging Service Request Module

Attribute Name	Tag	Expected Matching Key Type	Expected Returned Key Type	Mapped into the Image	Displayed to User	Updatable by User	Note
Accession Number	(0008,0050)	O	2	Yes	Yes	Yes if not provided by HIS	
Referring Physician's Name	(0008,0090)	O	2	Yes	Yes	Yes	

Table 6-6 IMAGING SERVICE REQUEST MODULE ATTRIBUTES

### 6.5.5 Visit Entity

#### 6.5.5.1 Visit Identification

None of the data element from Visit Identification Module are requested.

#### 6.5.5.2 Visit Status

None of the data element from Visit Status Module are requested.

#### 6.5.5.3 Visit Relationship

Attribute Name	Tag	Expected Matching Key Type	Expected Returned Key Type	Mapped into the Image	Displayed to User	Updatable by User	Note
Referenced Patient Sequence	(0008,1120)	O	2	Yes	No	No	
>Referenced SOP Class UID	(0008,1150)	O	2	Yes	No	No	
>Referenced SOP Instance UID	(0008,1155)	O	2	Yes	No	No	

Table 6-7 VISIT RELATIONSHIP MODULE ATTRIBUTES

#### 6.5.5.4 Visit Admission

None of the data elements from Visit Admission Module are requested.

### 6.5.6 Patient Entity

#### 6.5.6.1 Patient Relationship

None of the data elements from Patient Relationship Module are requested.

### 6.5.6.2 Patient Identification

Attribute Name	Tag	Expected Matching Key Type	Expected Returned Key Type	Mapped into the Image	Displayed to User	Updatable by User	Note
Patient's Name (	(0010,0010)	R	1	Yes	Yes	Yes if not provided by HIS	Matching is supported as follow: either no patient name is supplied (universal matching), or the patient name entered by the user in the Query Definition screen is supplied for matching
Patient ID	(0010,0020)	R	1	Yes	Yes	Yes if not provided by HIS	Matching is supported as follow: either no patient ID is supplied (universal matching), or the patient ID entered by the user in the Query Definition screen is supplied for matching

Table 6-8 PATIENT IDENTIFICATION MODULE ATTRIBUTES

### 6.5.6.3 Patient Demographic

Attribute Name	Tag	Expected Matching Key Type	Expected Returned Key Type	Mapped into the Image	Displayed to User	Updatable by User	Note
Patients Birth Date	(0010,0030)	O	2	Yes	Yes	Yes	Yes
Patient's Sex	(0010,0040)	O	2	Yes	Yes	Yes	Yes

Table 6-9 PATIENT DEMOGRAPHIC MODULE ATTRIBUTES

### 6.5.6.4 Patient Medical

None of the data elements from Patient Medical Module are requested

## 6.6 PRIVATE DATA DICTIONARY

The Acquisition Workstation implementation does not define any Private Attributes within the Modality Worklist Information Model.

# Section 7.0 NETWORK PRINT SCU CONFORMANCE STATEMENT

## 7.1 INTRODUCTION

This section of the DICOM Conformance Statement specifies the compliance to DICOM conformance requirements for the relevant Grayscale Network Printing features on this GEHC product. Note that the format of this section strictly follows the format defined in DICOM Standard PS 3.2 (Conformance). Please refer to that part of the standard while reading this section.

The Acquisition Workstation has the ability to compose films through the use of an application known as PRINT MANAGER. The Acquisition Workstation uses DICOM Print Management Service Class to send images to hard copy printers. The films can then be used for possible further analysis.

## 7.2 IMPLEMENTATION MODEL

### 7.2.1 Application Data Flow Diagram

The Basic and Specific Application models for this device are shown in the following Illustration:

**ILLUSTRATION 7-1**

**DICOM PRINT SCU APPLICATION ENTITY MODEL**

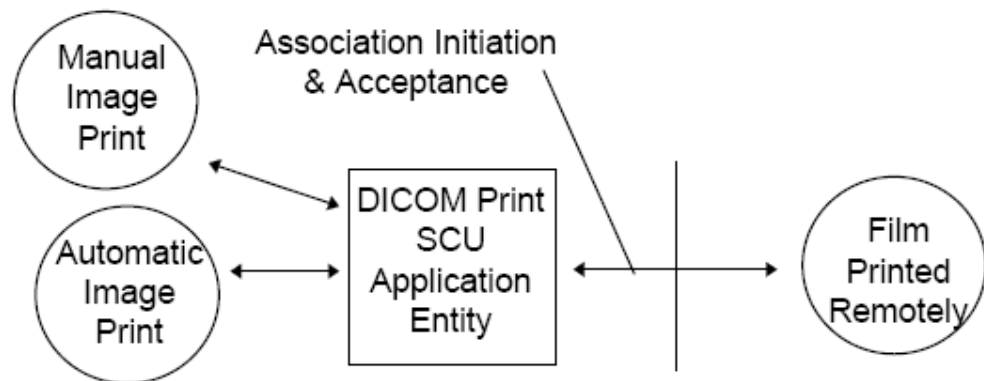

The DICOM Print SCU Application Entity (AE) is an application that handles DICOM protocol communication with Remote DICOM Printers. The DICOM Print SCU AE is activated when the user requests for a print or when automatic print is triggered at close exam time.

The DICOM Print SCU AE is invoked by the following Real World Activity:

- Manual Image Print

For this operation, the operator selects an image in the VIEWER, and then prints the image clicking on the PRINT button. The operator may also initiate a print by launching the scrapbook, loading an image, and clicking on the PRINT button.

- Automatic Image Print

For this operation, user set Auto-Print ON. Then when the operator acquires images, images are automatically printed at Close Exam time. In manual or automatic print, the PRINT MANAGER receives the "Simple print" request, composes a film then send the film to the selected Remote DICOM Printer.

## 7.2.2 Functional Definition of AE's

The DICOM Print SCU AE supports the following functions:

- Access to pixel data in the local database.
- Initiate a DICOM association to send DICOM SOP Classes (corresponding to the DICOM Print Management service class) to a remote DICOM Printer.

## 7.2.3 Sequencing of Real-World Activities

### 7.2.3.1 Manual Image Print

1. The user selects the remote DICOM Printer from the Print Manager GUI.
2. The user selects an image in the VIEWER, then prints the image using the "Simple print" function.
3. The PRINT MANAGER receives the "Simple print" request, composes a film then activates the DICOM Print SCU AE that initiates the following actions.
4. Initiates a DICOM association and selects a Presentation Context.
5. N-GETs printer status from the Printer SOP Instance  
If Printer Status is FAILURE  
Signal print failure to the user  
Association is aborted  
Else If Printer Status is WARNING and Printer Status Info is not equal to SUPPLY LOW or SUPPLY EMPTY  
Signal print warning to the user  
Association is released
6. N-CREATEs a Basic Film Session SOP Instance.
7. N-CREATEs a Basic Film Box SOP Instance for the current film.
8. N-SETs the Basic Film Box SOP Instance with the Image Box SOP Instance for each image on the film.
9. N-ACTIONs on the Basic Film Box SOP Instance.
10. N-DELETEs on the Basic Film Box SOP Instance.

### 7.2.3.2 Automatic Image Print

Same as Manual Print except step 1 and 2 to be replaced by:

1. User sets Auto-Print ON, defines auto-print parameters, and configures the Quality Check default to "OK to print" or "Not OK to print" from Medical Applications Preferences.
2. User starts an exam and acquires images.
3. User sets the Quality Check flag to "OK to print" or "Not OK to print".
4. User clicks on CLOSE EXAM.
5. All images with the Quality Check flag set to "OK to print" are automatically printed.



## 7.3 AE SPECIFICATIONS

### 7.3.1 DICOM Print SCU AE Specification

This Application Entity provides Standard Conformance to the following DICOM V3.0 SOP Classes as a SCU:

SOP Class Name	SOP Class UID
Basic Grayscale Print Management Meta SOP Class	1.2.840.10008.5.1.1.9

**Note:** Support of the Basic Grayscale Print Management Meta SOP Class as an SCU mandates support for the Basic Film Session, Basic Film Box, Basic Grayscale Image Box and Printer SOP Classes as a SCU.

#### 7.3.1.1 Association Establishment Policies

##### 1. General

The DICOM Application Context Name (ACN), which is always proposed, is:

Application Context Name	1.2.840.10008.3.1.1.1
--------------------------	-----------------------

The Maximum Length PDU negotiation is included in all association establishment requests. The maximum length PDU for an association initiated by the DICOM Print SCU is:

Maximum Length PDU	16384
--------------------	-------

The Print Management Service Class does not support extended negotiation. The maximum number of Presentation Context Items that will be proposed is: 6. The user information Items sent by this product are:

- Maximum PDU Length
- Implementation UID
- Implementation Version Name

##### 2. Number of Associations

The DICOM Print SCU AE supports 2 parallel associations at a time. Requests are internally queued.

##### 3. Asynchronous Nature

Asynchronous mode is not supported. All operations will be performed synchronously.

##### 4. Implementation Identifying Information

The Implementation UID for this DICOM Implementation is:

Discovery XR656 Acquisition Workstation Implementation UID	1.2.840.113619.6.369
--	----------------------

Optima XR646 Acquisition Workstation Implementation UID	1.2.840.113619.6.370
---	----------------------

Definium 6000 Acquisition Workstation Implementation UID	1.2.840.113619.6.370
--	----------------------

Discovery XR656 Acquisition Workstation Implementation UID | 1.2.840.113619.6.203

The Implementation Version Name for this DICOM V3.0 Implementation is:

Discovery XR656 Acquisition Workstation Implementation Version Name | Discovery XR656

Optima XR646 Acquisition Workstation Implementation Version Name | Optima XR646

Definium 6000 Acquisition Workstation Implementation Version Name | Optima XR646

Discovery XR656 Acquisition Workstation Implementation Version Name | Global 1 Platform

### 7.3.1.2 Association Initiation Policy

The DICOM Print SCU AE initiates one association with the selected REMOTE DICOM Printer. No other association can be opened by the DICOM Print SCU AE while the current association is active.

#### 1. Real-World Activity “Manual Image Print”

##### 1.1 Associated Real-World Activity

The operator does the following:

- \* 1. Select an image in Viewer.
- \* 2. Clicks on Print Button.
- \* 3. Print window is displayed. User checks or modifies selected printer and print parameters (film format, number of copies, pixel depth, etc...).
- \* 4. Clicks on Print to confirm.

This operation will cause the DICOM PRINT SCU AE to try to establish the association with the requested printer and sends the images for printing.

#### 1.2 Proposed Presentation Context Table

Presentation Context Table - Proposed

Abstract Syntax		Transfer Syntax		Role	Extended Negotiation
Name	UID	Name List	UID List		
Basic Grayscale Print Management Meta SOP Class	1.2.840.10008.5.1.1.9	Implicit VR Little Endian	1.2.840.10008.1.2	SCU	None

#### 1.2.1 SOP Specific DICOM Conformance Statement for Print Management SOP Classes

For each of the supported Print Management SOP and Meta SOP Classes, the optional attributes and service elements supported, the valid range of values for mandatory and optional attributes, and the status code behavior are described in Annex.

#### 2.Real-World Activity “Automatic Image Print”

##### 2.1 Associated Real-World Activity

The operator does the following:

- \* 1. Set Auto-Print ON and define the auto-print parameters using MEDICAL APPLICATION PREFERENCES option of the Browser toolkit menu.
- \* 2. Starts an exam.
- \* 3. Acquires images.
- \* 4. Clicks on CLOSE EXAM.

This operation will cause the DICOM PRINT SCU AE to try to establish the association with the requested printer and sends the acquired images for printing.

2.2. Proposed Presentation Context Table

Same as "Manual Image Print" real world activity.

2.2.1 SOP Specific DICOM Conformance Statement for Print Management SOP Classes

Same as "Manual Image Print" real world activity.

## 7.4 COMMUNICATION PROFILES

### 7.4.1 Supported Communication Stacks (PS 3.8, PS 3.9)

DICOM Upper Layer (PS 3.8) is supported using TCP/IP.

### 7.4.2 OSI Stack

OSI stack not supported.

### 7.4.3 TCP/IP Stack

The TCP/IP stack is inherited from a UNIX Operating System.

#### 7.4.3.1 API

Not applicable to this product.

#### 7.4.3.2 Physical Media Support

DICOM is indifferent to the Physical medium over which TCP/IP executes (e.g. Ethernet V2.0, IEEE 802.3, ATM, FDDI)

Note: For more information about the Physical Media available on Acquisition Workstation, please refer to the Product Data Sheet.

### 7.4.4 Point-to-Point Stack

A 50-pin ACR-NEMA connection is not applicable to this product.

## 7.5 EXTENSIONS / SPECIALIZATIONS / PRIVATIZATIONS

### 7.5.1 Standard Extended /Specialized/Private SOP Classes

No Standard Extended, no Specialized, no Private SOP Classes are managed by this application.

### 7.5.2 Private Transfer Syntaxes

No Private Transfer Syntaxes are managed by this product.

---

## 7.6 CONFIGURATION

### 7.6.1 AE Title/Presentation Address Mapping

The PRINT MANAGER application allows the user to add, delete, or update the following Remote DICOM Printers parameters:

- AE Title
- DICOM Port Number
- IP address

### 7.6.2 Configurable Parameters

The following fields are configurable for every remote DICOM AE:

- Remote AE Title
- Remote IP Address
- Listening TCP/IP Port Number

Only one default router IP Address can be configured for all DICOM remote nodes (including printers, Storage SCP Workstations, ...)

## 7.7 SUPPORT OF EXTENDED CHARACTER SETS

The Acquisition Workstation will support only the ISO\_IR 100 (ISO 8859-1:1987 Latin alphabet N 1. supplementary set) as extended character sets. Any incoming SOP instance that is encoded using another extended character set will not be installed in the local database.

# Section 8.0 PRINT MANAGEMENT SOP CLASS DEFINITION

## 8.1 INTRODUCTION

This section of the DICOM Conformance Statement specifies the supported Print Management SOP and Meta SOP Classes, the optional attributes and service elements supported, the valid range of values for mandatory and optional attributes, and the status code behavior.

This section contains:

- 8.2.1 Basic Film Session SOP Class
- 8.2.2 Basic Film Box SOP Class
- 8.2.3 Image Box SOP Classes
- 8.2.4 Printer SOP Class
- 8.2.5 Print Job SOP Class
- 8.2.6 Basic Annotation Box SOP Class
- 8.2.7 Image Overlay Box SOP Class

## 8.2 PRINT MANAGEMENT SOP CLASS DEFINITIONS

### 8.2.1 Basic Film Session SOP Class

The DICOM Print SCU AE supports the N-CREATE DIMSE Service Element for the Basic Film Session SOP Class.

- The N-CREATE DIMSE Service element sent by the DICOM Print SCU AE requests the Remote DICOM Print SCP to create an instance of Basic Film Session.

#### 8.2.1.1 IOD Description

1. IOD modules

Module	Reference	Module Description
SOP Common		Contains SOP Common information
Basic Film Session Presentation Module	8.2.1.1.2	Contains Film Session presentations information
Basic Film Session Relationship	8.2.1.1.3	References to related SOPs

2. Basic Film Session Presentation Module

Attribute name	Tag	Attribute Description
Number of Copies	(2000,0010)	1 to 10 when using Scrapbook Print. 1 to 9 when using Standard Print.
Print Priority	(2000,0020)	LOW
Medium Type	(2000,0030)	PAPER FILM CLEAR FILM BLUE FILM
Film Destination	(2000,0040)	MAGAZINE PROCESSOR
Film Session Label	(2000,0050)	Not sent.

3 Basic Film Session Relationship Module

Attribute name	Tag	Attribute Description
Referenced Film Box Sequence	(2000,0500)	Not sent.
>Referenced SOP Class UID	(0008,1150)	Not sent.
>Referenced SOP Instance UID	(0008,1155)	Not sent.

### 8.2.1.2 DIMSE Service Group

DIMSE Service Element	Usage SCU
N-CREATE	M
N-SET	Not used
N-DELETE	Used
N-ACTION	Not used

#### 1. N-CREATE

##### a. Attributes

Attribute name	Tag	Usage SCU
Number of Copies	(2000,0010)	Used
Print Priority	(2000,0020)	Used
Medium Type	(2000,0030)	Used
Film Destination	(2000,0040)	Used
Film Session Label	(2000,0050)	Not used
Memory Allocation	(2000,0060)	Not used

##### b. Status

Service Status	Status Codes	Further Meaning	Application Behavior When receiving Status Codes
Warning	B600	Memory allocation not supported	Association is aborted
Success	0000	Film session successfully created	Next step describe in the sequencing of Real-World Activities paragraph is performed

##### c. Behavior

No specific behavior.

#### 2. N-SET

This service is not used.

#### 3. N-DELETE

This service is not used.

#### 4. N-ACTION

This service is not used.

## 8.2.2 Basic Film Box SOP Class

The DICOM Print SCU AE supports the following DIMSE Service Element for the Basic Film Box SOP Class.

- The N-CREATE DIMSE Service element sent by the DICOM Print SCU AE requests the Remote DICOM Print SCP to create an instance of Basic Film Box
- The N-ACTION DIMSE Service element sent by the DICOM Print SCU AE requests the Remote DICOM Print SCP to print the Basic Film Box onto the hard copy printer.
- The N-DELETE DIMSE Service element sent by the DICOM Print SCU AE requests the Remote DICOM Print SCP to release the Basic Film Box instance.

### 8.2.2.1 IOD Description

1 IOD modules

Module	Reference	Module Description
SOP Common		Contains SOP Common information
Basic Film Box Presentation Module	0	Contains Film Box presentation information
Basic Film Box Relationship	8.2.2.1.3	References to related SOPs

2 Basic Film Box Presentation Module

Attribute name	Tag	Attribute Description
Image Display Format	(2010,0010)	STANDARD\1,1 STANDARD\1,2 STANDARD\2,1 STANDARD\2,2
Annotation Display Format ID	(2010,0030)	Not sent.
Film Orientation	(2010,0040)	PORTRAIT LANDSCAPE
Film Size ID	(2010,0050)	8INX10IN 10INX12IN 10INX14IN 11INX14IN 14INX14IN 14INX17IN 24CMX24CM 24CMX30CM
Magnification Type	(2010,0060)	REPLICATE BILINEAR CUBIC NONE
Smoothing Type	(2010,0080)	Only valid for Magnification type = CUBIC
Border density	(2010,0100)	BLACK
Empty Image Density	(2010,0110)	Not sent.
Min Density	(2010,0120)	-1 by default or set to positive integer
Max Density	(2010,0130)	-1 by default or set to positive integer
Trim	(2010,0140)	YES NO
Configuration Information	(2010,0150)	Empty by default or set to a value defined when printer is declared.

3. Basic Film Box Relationship Module



Attribute name	Tag	Attribute Description
Referenced Film Session Sequence	(2010,0500)	Referenced Film Session Sequence
>Referenced SOP Class UID	(0008,1150)	1.2.840.10008.5.1.1.1
>Referenced SOP Instance UID	(0008,1155)	Referenced SOP Instance UID
Referenced Image Box Sequence	(2010,0510)	Empty
>Referenced SOP Class UID	(0008,1150)	Empty
>Referenced SOP Instance UID	(0008,1155)	Empty
Referenced Basic Annotation Box Sequence	(2010,0520)	Empty
>Referenced SOP Class UID	(0008,1150)	Empty
>Referenced SOP Instance UID	(0008,1155)	Empty

**8.2.2.2 DIMSE Service Group**

DIMSE Service Element	Usage SCU
N-CREATE	M
N-ACTION	M
N-DELETE	Used

1 N-CREATE

a.Attributes

Attribute name	Tag	Usage SCU
Image Display Format	(2010,0010)	M
Referenced Film Session Sequence	(2010,0500)	M
>Referenced SOP Class UID	(0008,1150)	M
>Referenced SOP Instance UID	(0008,1155)	M
Referenced Image Box Sequence	(2010,0510)	Not used
>Referenced SOP Class UID	(0008,1150)	Not used
>Referenced SOP Instance UID	(0008,1155)	Not used
Referenced Basic Annotation Box Sequence	(2010,0520)	Not used
>Referenced SOP Class UID	(0008,1150)	Not used
>Referenced SOP Instance UID	(0008,1155)	Not used
Annotation Display Format ID	(2010,0030)	Not used
Film Orientation	(2010,0040)	Used
Film Size ID	(2010,0050)	Used
Magnification Type	(2010,0060)	Used
Smoothing Type	(2010,0080)	Used, not sent if empty or magnification is not equal to CUBIC
Border Density	(2010,0100)	Used
Empty Image Density	(2010,0110)	Not Used
Min Density	(2010,0120)	Used, not sent if = -1
Max Density	(2010,0130)	Used, not sent if = -1
Trim	(2010,0140)	Used
Configuration Information	(2010,0150)	Used, not sent if empty

b. Status

There are no specific status codes.

c. Behavior

There is no specific behavior.

2. N-DELETE

a. Behavior

The SCU uses the N-DELETE to request the SCP to delete the Basic Film Box SOP Instance hierarchy.

3. N-ACTION

N-ACTION is used to print the current film of the film session.

a. Attributes

Action Type Name	Action Type ID	Attribute	Tag	Usage SCU
Print	1	Referenced Print Job Sequence	(2100,0500)	Not used
		>Referenced SOP Class UID	(0008,1150)	Not used
		>Referenced SOP Instance UID	(0008,1155)	Not used

b. Status

Service Status	Status Codes	Further Meaning	Application Behavior When receiving Status Codes
Success	0000	Film accepted for printing.	Next step describe in the sequencing of Real-World Activities paragraph is performed
Warning	B603	Film Box SOP Instance hierarchy does not contain Image Box SOP Instances (empty page)	This case should not happen. This warning is considered as an error. Association is aborted.
Failure	C602	Unable to create Print Job SOP Instance; print queue is full	Appropriate message is returned to the user. Association is aborted.
	C604	Image position collision : multiple images assigned to single image position	Appropriate message is returned to the user. Association is aborted.
	C603	Image size is larger than image box size (by using the specified magnification value)	Appropriate message is returned to the user. Association is aborted.

c. Behavior

SCU uses the N-ACTION to request the SCP to print one or more copies of a single film of the film session.

**8.2.3 Image Box SOP Classes**

**8.2.3.1 Basic Grayscale Image Box SOP Class**

The DICOM Print SCU AE supports the following DIMSE Service Element for the Basic Grayscale Image Box SOP Class.

- The N-SET DIMSE Service element sent by the DICOM Print SCU AE requests the Remote DICOM Print SCP to set the attributes of the Basic Grayscale Image Box Instance.

1. IOD description

a. IOD modules

Module	Reference	Module Description
SOP Common		Contains SOP Common information
Image Box Presentation Module	8.2.3.1.1.2	Contains Image Box presentation information
Image Box Relationship Module	0	References to related SOPs

b. Image Box Pixel Presentation Module

Attribute name	Tag	Attribute Description
Image Position	(2020,0010)	1
Polarity	(2020,0020)	NORMAL = pixels shall be printed as specified by the Photometric Interpretation (0028,0004) REVERSE = pixels shall be printed with the opposite polarity as specified by the Photometric Interpretation (0028,0004)
Magnification Type	(2010,0060)	Same value as defined in the Film Box.
Smoothing Type	(2010,0080)	Same value as defined in the Film Box
Configuration Information	(2010,0150)	Same value as defined in the Film Box.
Requested Image Size	(2020,0030)	Not Sent
Preformatted Grayscale Image Sequence	(2020,0110)	This sequence is always included if the Image Box is a Basic Grayscale Image Box
>Samples Per Pixel	(0028,0002)	1
>Photometric Interpretation	(0028,0004)	MONOCHROME2
>Rows	(0028,0010)	Original image height
>Columns	(0028,0011)	Original image width
>Pixel Aspect Ratio	(0028,0034)	1\1
>Bits Allocated	(0028,0100)	Depends on the original image pixel depth (8 or 16).
>Bits Stored	(0028,0101)	Original image pixel depth (8, 10 or 12 bits).
>High Bit	(0028,0102)	Depends on the original image pixel depth (7, 9 or 11).
>Pixel Representation	(0028,0103)	0 (Unsigned Integer)
>Pixel Data	(7FE0,0010)	

c. Image Box Relationship Module

Attribute name	Tag	Attribute Description
Referenced Image Sequence	(0008,1140)	Not used
>Referenced SOP Class UID	(0008,1150)	Not used

>Referenced SOP Instance UID	(0008,1155)	Not used
>Referenced Frame Number	(0008,1160)	Not used
Referenced Image Overlay Box Sequence	(2020,0130)	Not used
>Referenced SOP Class UID	(0008,1150)	Not used
>Referenced SOP Instance UID	(0008,1155)	Not used
>Referenced Frame Number	(0008,1160)	Not used
Referenced VOI LUT Sequence	(2020,0140)	Not used
>Referenced SOP Class UID	(0008,1150)	Not used
>Referenced SOP Instance UID	(0008,1155)	Not used

2. DIMSE Service Group

DIMSE Service Element	Usage SCU
N-SET	M

a. N-SET

- Attributes

Attribute name	Tag	Usage SCU
Image Position	(2020,0010)	M
Preformatted Grayscale Image Sequence	(2020,0110)	M
>Samples Per Pixel	(0028,0002)	M
>Photometric Interpretation	(0028,0004)	M
>Rows	(0028,0010)	M
>Columns	(0028,0011)	M
>Pixel Aspect Ratio	(0028,0034)	1\1
>Bits Allocated	(0028,0100)	M
>Bits Stored	(0028,0101)	M
>High Bit	(0028,0102)	M
>Pixel Representation	(0028,0103)	M
>Pixel Data	(7FE0,0010)	M
Polarity	(2020,0020)	Used
Referenced Overlay Sequence	(0008,1130)	Not used
>SOP Class UID	(0008,1150)	Not used
>SOP Instance UID	(0008,1155)	Not used
Configuration Information	(2010,0150)	Used, not sent if empty
Magnification Type	(2010,0060)	Used
Smoothing Type	(2010,0080)	Used, not sent if empty or magnification is not equal to CUBIC
Requested Image Size	(2020,0030)	Not used

- Status

Service Status	Status Codes	Further Meaning	Application Behavior When receiving Status Codes
Failure	C605	Insufficient memory in printer to store the image	Appropriate message is returned to the user. Association is aborted.

- Behavior

There is no specific behavior.

The SCU does not instruct the SCP to erase the image in the image position by setting a zero length and no value in the Attribute Preformatted Grayscale Image Sequence (2020,0110) or Preformatted Grayscale Image Sequence (2020,0111)Printer SOP Class

The DICOM Print SCU AE supports the following DIMSE Service Element for the Basic Printer SOP Class.

The N-EVENT\_REPORT DIMSE Service element sent by the DICOM Print SCP to the local DICOM Print SCU AE. The DICOM Print SCU handles the Printer Status and Printer Status Info fields. All other received data are ignored.

The N-GET DIMSE Service element sent by the DICOM Print SCU AE requests the Remote DICOM Print SCP to give information on the Remote DICOM Printer.

### 8.2.3.2 IOD Description

#### 1. IOD modules

Module	Reference	Module Description
SOP Common		Contains SOP Common informationM
Printer Module	8.2.4.1.2	Contains status information to monitor the printer

#### 2. Printer Module

Attribute name	Tag	Attribute Description
Manufacturer	(0008,0070)	Printer shall return value
Manufacturer Model Name	(0008,1090)	Printer shall return value
Device Serial Number	(0018,1000)	Printer shall return value
Software Versions	(0018,1020)	Printer shall return value
Date Of Last Calibration	(0018,1200)	Printer shall return value
Time Of Last Calibration	(0018,1201)	Printer shall return value
Printer Status	(2110,0010)	The behaviour defined for the following term NORMAL : Association goes on. FAILURE : Association is aborted. WARNING : Association is released except if Printer Status Info is: SUPPLY LOW SUPPLY EMPTY
Printer Status Info	(2110,0020)	The behaviour is defined for SUPPLY LOW and SUPPLY EMPTY (See upwards)
Printer Name	(2110,0030)	Printer shall return value

### 8.2.3.3 DIMSE Service Group

DIMSE Service Element	Usage SCU
N-EVENT-REPORT	M
N-GET	U

1. N-EVENT-REPORT

a. Attributes

Event Type Name	Event Type ID	Attribute	Tag	Usage SCU
Normal	1			
Warning	2	Printer Name	(2110,0030)	
		Printer Status Info	(2110,0020)	
Failure	3	Printer Name	(2110,0030)	
		Printer Status Info	(2110,0020)	

Note: The N-EVENT-REPORT default timeout is set to 30 secs.

b. Behavior

If {Printer Status} is FAILURE

Signal print FAILURE to the user, association is aborted

Else

Signal print SUCCESS to the user

2. N-GET

a. Attributes

Attribute name	Tag	Usage SCU
Manufacturer	(0008,0070)	Used
Manufacturer Model Name	(0008,1090)	Used
Device Serial Number	(0018,1000)	Used
Software Versions	(0018,1020)	Used
Date Last Calibration	(0018,1200)	Used
Last Calibration	(0018,1201)	Used
Printer Status	(2110,0010)	Used
Printer Status Info	(2110,0020)	Used
Printer Name	(2110,0030)	Used

b. Behavior

If Printer Status is FAILURE

Signal print failure to the user

Else

Signal print success to the user

**8.2.4 Print Job SOP Class**

This SOP Class is not supported by this implementation.

**8.2.5 Basic Annotation Box SOP Class**

This SOP Class is not supported by this implementation.

**8.2.6 Image Overlay Box SOP Class**

This SOP Class is not supported by this implementation.

# Section 9.0 STORAGE COMMITMENT PUSH MODEL SOP CLASS DEFINITION

## 9.1 INTRODUCTION

This section of the DICOM Conformance Statement specifies the Storage Commitment Push Model SOP Class, the optional attributes and service elements supported, the valid range of values for mandatory and optional attributes, and the status code behavior.

## 9.2 STORAGE COMMITMENT PUSH MODEL SOP CLASS DEFINITION

### 9.2.1 IOD Description

#### 9.2.1.1 STORAGE COMMITMENT MODULE

Attribute Name	Tag	Attribute Description
Retrieve AE Title	(0008,0054)	When received in N-EVENT-REPORT, it is supported but ignored.
Transaction UID	(0008,1195)	
Storage Media File-Set ID	(0088,0130)	When received in N-EVENT-REPORT, it is supported but ignored.
Storage Media File-Set UID	(0088,0140)	When received in N-EVENT-REPORT, it is supported but ignored.
Referenced SOP Sequence	(0008,1199)	
>Referenced SOP Class UID	(0008,1150)	
>Referenced SOP Instance UID	(0008,1155)	
>Retrieve AE Title	(0008,0054)	Supported but ignored
>Storage Media File-Set ID	(0088,0130)	Supported but ignored
>Storage Media File-Set UID	(0088,0140)	Supported but ignored
Referenced Study Component Sequence	(0008,1111)	Not sent.
>Referenced SOP Class UID	(0008,1150)	
>Referenced SOP Instance UID	(0008,1155)	
Failed SOP Sequence	(0008,1198)	
>Referenced SOP Class UID	(0008,1150)	
>Referenced SOP Instance UID	(0008,1155)	
>Failure Reason	(0008,1197)	All values from the following table are supported.

**Table 9-1 STORAGE COMMITMENT MODULE**

Failure Reason	Meaning	SCU Behavior
0110H	Processing failure	Logged into log file Pop-up displayed to user to warn him that images from patient X could not be committed.

**Table 9-2 FAILURE REASON VALUES AND SEMANTICS**

0112H	No such object instance	Logged into log file Pop-up displayed to user to warn him that images from patient X could not be committed.
0213H	Resource limitation	Logged into log file Pop-up displayed to user to warn him that images from patient X could not be committed.
0122H	Referenced SOP Class not supported	Logged into log file Pop-up displayed to user to warn him that images from patient X could not be committed.
0119H	Class / Instance conflict	Logged into log file Pop-up displayed to user to warn him that images from patient X could not be committed.
0131H	Duplicate transaction UID	Logged into log file Pop-up displayed to user to warn him that images from patient X could not be committed.

Table 9-2 FAILURE REASON VALUES AND SEMANTICS

## 9.2.2 DIMSE Service Group

DIMSE Service Element	Usage SCU/SCP
N-EVENT-REPORT	M/M
N-ACTION	M/M

## 9.2.3 Operations

### 9.2.3.1 Action Information

Action Type Name	Action Type ID	Attribute	Tag	Requirement Type SCU/SCP
Request Storage Commitment	1	Transaction UID	(0008,1195)	1/1
		Referenced SOP Sequence	(0008,1199)	1/1
		>Referenced SOP Class UID	(0008,1150)	1/1
		>Referenced SOP Instance UID	(0008,1155)	1/1

Table 9-3 STORAGE COMMITMENT REQUEST - ACTION INFORMATION

### 9.2.3.2 Service Class User Behavior

N-ACTION is sent when the images are successfully sent to a remote host declared as Storage Commitment Provider on the Acquisition Workstation.

Storage Commitment can be requested for Digital X-ray SOP Class Images For Presentation and For Processing.

Storage Commitment is never requested for images sent to remote host with CR Fallback (see definition in Network Conformance Statement section).



Referenced Study Component Sequence Attribute is not supported.

The transaction UID is applicable until the N-EVENT-REPORT is received.

Storage Media File-Set ID & UID Attributes in the N-ACTION are not supported.

When receiving an unsuccessful N-ACTION Response Status Code from the SCP, we log the error in a log file and we display a pop-up to the user.

### 9.2.3.3 Status Codes

No Service Class specific status values are defined for the N-ACTION Service.

See PS 3.7 for general response status codes.

## 9.2.4 Notifications

### 9.2.4.1 Event Information

Event Type Name	Event Type ID	Attribute	Tag	Requirement Type SCU/SCP
Storage Commitment Request Successful	1	Transaction UID	(0008,1195)	-/1
		Referenced SOP Sequence	(0008,1199)	-/1
		>Referenced SOP Class UID	(0008,1150)	-/1
		>Referenced SOP Instance UID	(0008,1155)	-/1
Storage Commitment Request Complete - Failures Exist	2	Transaction UID	(0008,1195)	-/1
		Referenced SOP Sequence	(0008,1199)	-/1C
		>Referenced SOP Class UID	(0008,1150)	-/1
		>Referenced SOP Instance UID	(0008,1155)	-/1
		Failed SOP Sequence	(0008,1198)	-/1
		>Referenced SOP Class UID	(0008,1150)	-/1
		>Referenced SOP Instance UID	(0008,1155)	-/1
>Failure Reason	(0008,1197)	-/1		

**Table 9-4 STORAGE COMMITMENT RESULT - EVENT INFORMATION**

**9.2.4.2 Service Class User Behavior**

When receiving the N-EVENT-REPORT, system looks first for the SOP Instance UID successfully committed. It records them in a log file and flags them in the local database as "Committed". Secondly, the system looks for the SOP Instance UID for which the commit failed. It also records them in a log file with the failure reason and display a pop-up to the user.

**9.2.4.3 Status Codes**

No Service Class specific status values are defined for the N-EVENT-REPORT Service. See PS 3.7 for general response status codes.

# Section 10.0 MODALITY PERFORMED PROCEDURE STEP IMPLEMENTATION

## 10.1 MODALITY PERFORMED PROCEDURE STEP MODULE TABLE

See DICOM PS 3.3 and PS 3.4 for a complete definition of the entities, modules, and attributes.

Module Name	Reference
SOP Common	C.12.1
Performed Procedure Step Relationship	C.4.13
Performed Procedure Step Information	C.4.14
Image Acquisition Results	C.4.15
Radiation Dose	C.4.16
Billing and Material Management Codes	Not Supported

**Table 10-1 MODALITY PERFORMED PROCEDURE STEP MODULES**

## 10.2 MODALITY PERFORMED PROCEDURE STEP MODULE DEFINITIONS

Please refer to DICOM Standard PS 3.3. (Information Object Definitions) for a description of each of the attributes contained within the Modality Performed Procedure Step Information Object Definition.

### 10.2.1 SOP Common Module

Attribute Name	Tag	Type for SCU N-CREATE	Type for SCU N-SET	Use
Specific Character Set	(0008,0005)	1C	1C	Not used but copied into the MPPS Object

**Table 10-2 SOP COMMON MODULE ATTRIBUTES**

### 10.2.2 Performed Procedure Step Relationship Module

Attribute Name	Tag	Type for SCU N-CREATE	Type for SCU N-SET	Use
Patient's Name	(0010,0010)	2	-	Copied from the SPS.
Patient ID	(0010,0020)	2	-	Copied from the SPS.
Patient's Birth Date	(0010,0030)	2	-	Copied from the SPS.
Patient's Sex	(0010,0040)	2	-	Copied from the SPS.
Referenced Patient Sequence	(0008,1120)	2	-	Copied from the SPS.
>Referenced SOP Class UID	(0008,1150)			Copied from the SPS.
>Referenced SOP Instance UID	(0008,1155)			Copied from the SPS.
Scheduled Step Attributes Sequence	(0040,0270)	1	-	Copied from the SPS.
>Study Instance UID	(0020,000D)	1	-	Copied from the SPS.
>Referenced Study Sequence	(0008,1110)	2	-	Copied from the SPS.
>>Referenced SOP Class UID	(0008,1150)			Copied from the SPS.

**Table 10-3 PERFORMED PROCEDURE STEP RELATIONSHIP MODULE ATTRIBUTES**

>>Referenced SOP Instance UID	(0008,1155)			Copied from the SPS.
>Accession Number	(0008,0050)	2	-	Copied from the SPS.
>Requested Procedure ID	(0040,1001)	2	-	Copied from the SPS.
>Requested Procedure Description	(0032,1060)	2	-	Copied from the SPS.
>Scheduled Procedure Step ID	(0040,0009)	2	-	Copied from the SPS.
>Scheduled Procedure Step Description	(0040,0007)	2	-	Copied from the SPS.
>Scheduled Protocol Code Sequence	(0040,0008)	2	-	Copied from the SPS.
>> 'Code Sequence Macro'				Copied from the SPS.

Table 10-3 PERFORMED PROCEDURE STEP RELATIONSHIP MODULE ATTRIBUTES

### 10.2.3 Performed Procedure Step Information Module

Attribute Name	Tag	Type for SCU N-CREATE	Type for SCU N-SET	Use
Performed Station AE Title	(0040,0241)	1	-	Local System AE Title
Performed Station Name	(0040,0242)	2	-	Local Station Name as configured in Service User Interface
Performed Location	(0040,0243)	2	-	Local System ID as configured in Service User Interface
Performed Procedure Step Start Date	(0040,0244)	1	-	Same as Start Exam Date
Performed Procedure Step Start Time	(0040,0245)	1	-	Same as Start Exam Time
Performed Procedure Step ID	(0040,0253)	1	-	Created by the Acquisition System.
Performed Procedure Step End Date	(0040,0250)	2	3	The Date when Complete PPS/ Discontinue PPS is invoked from the UI.
Performed Procedure Step End Time	(0040,0251)	2	3	The Time when Complete PPS/ Discontinue PPS is invoked from the UI.
Performed Procedure Step Status	(0040,0252)	1	3	See Note 1 at the end of this Table
Performed Procedure Step Description	(0040,0254)	2	3	Copied from SPS
Comments on the Performed Procedure Step	(0040,0280)	3	3	
Performed Procedure Type Description	(0040,0255)	2	3	
Procedure Code Sequence > 'Code Sequence Macro'	(0008,1032)	2	3	Not sent as part of MPPS Object Not sent as part of MPPS Object
Performed Procedure Step Discontinuation Reason Code Sequence > 'Code Sequence Macro'	(0040,0281)	3	3	Sent when exam is Discontinued and carries discontinue reason as selected by the User on the UI.

Table 10-4 PERFORMED PROCEDURE STEP INFORMATION MODULE ATTRIBUTES

**Note 1:**

- When PPS Start (N-CREATE) message is sent, this element will have the value “INPROGRESS”
- When PPS end (N-SET) message is sent, this element will have either “COMPLETE” or “DICONTINUE”

**10.2.4 Image Acquisition Results Module**

Attribute Name	Tag	Type for SCU N-CREATE	Type for SCU N-SET	Use
Modality	(0008,0060)	1	-	DX
Study ID	(0020,0010)	2	-	
Performed Protocol Code Sequence	(0040,0260)	2	3	
> 'Code Sequence Macro'				
Performed Series Sequence	(0040,0340)	2	3	One item per series created
>Performing Physician's Name	(0008,1050)	2	2	Copied from SPS/ UI selection
>Operator's Name	(0008,1070)	2	2	Copied from SPS/ UI selection
>Protocol Name	(0018,1030)	1	1	Copied from SPS/ UI selection
>Series Instance UID	(0020,000E)	1	1	System generated UID
>Series Description	(0008,103E)	2	2	Copied from SPS/ UI selection
>Retrieve AE Title	(0008,0054)	2	2	Local System AE Title
>Referenced Image Sequence	(0008,1140)	2	2	One item per each image created within the series
>>Referenced SOP Class UID	(0008,1150)	1	1	
>>Referenced SOP Instance UID	(0008,1155)	1	1	
>Referenced Non-Image Composite SOP Instance Sequence	(0040,0220)	2	2	Not Sent
>>Referenced SOP Class UID	(0008,1150)	1	1	Not Sent
>>Referenced SOP Instance UID	(0008,1155)	1	1	Not Sent

**Table 10-5 IMAGE ACQUISITION RESULTS MODULE ATTRIBUTES**

10.2.5 Radiation Dose Module

Attribute Name	Tag	Type for SCU N-CREATE	Type for SCU N-SET	Use
Anatomic Structure, Space or Region Sequence > 'Code Sequence Macro'	(0008,2229)	3	3	Carries the same value as in Anatomic region value (0008,2218) When 1 exam contain multiple sequence, this tag sequence should be include zero or one item Not Sent
Total Time of Fluoroscopy	(0040,0300)	3	3	Not Sent
Total Number of Exposures	(0040,0301)	3	3	Total number of acquisitions performed during this PPS
Distance Source to Detector (SID)	(0018,1110)	3	3	
Distance Source to Entrance	(0040,0306)	3	3	
Entrance Dose	(0040,0302)	3	3	Cumulative entrance dose for the PPS
Entrance Dose in mGy	(0040,8302)	3	3	Cumulative entrance dose for the PPS
Exposed Area	(0040,0303)	3	3	
Image Area Dose Product	(0018,115E)	3	3	Cumulative Dose area product for the PPS
Comments on Radiation Dose	(0040,0310)	3	3	Comments sent if the PPS includes a Non Digital acquisition
Exposure Dose Sequence	(0040,030E)	3	3	Information carried from each source image.
>Radiation Mode	(0018,115A)	3	3	
kVp	(0018,0060)	3	3	
>X-ray Tube Current in $\mu$ A	(0018,8151)	3	3	
>Exposure Time	(0018,1150)	3	3	
>Filter Type	(0018,1160)	3	3	
>Filter Material	(0018,7050)	3	3	

Table 10-6 RADIATION DOSE MODULE ATTRIBUTES

**10.2.6 Billing and Material Management Codes Module**

Attribute Name	Tag	Type for SCU N-CREATE	Type for SCU N-SET	Use
Billing Procedure Step Sequence	(0040,0320)	3	3	Not Sent
> 'Code Sequence Macro'				Not Sent
Film Consumption Sequence	(0040,0321)	3	3	Not Sent
>Number of Films	(2100,0170)	3	3	Not Sent
>Medium Type	(2000,0030)	3	3	Not Sent
>Film Size ID	(2010,0050)	3	3	Not Sent
Billing Supplies and Devices Sequence	(0040,0324)	3	3	Not Sent
>Billing Item Sequence	(0040,0296)	3	3	Not Sent
>> 'Code Sequence Macro'				Not Sent
>Quantity Sequence	(0040,0293)	3	3	Not Sent
>>Quantity	(0040,0294)	3	3	Not Sent
>>Measuring Units Sequence	(0040,0295)	3	3	Not Sent
>>> 'Code Sequence Macro'				Not Sent

**Table 10-7 BILLING AND MATERIAL MANAGEMENT CODES MODULE ATTRIBUTES**

**10.3 STANDARD EXTENDED AND PRIVATE DATA ATTRIBUTES**

Not Present

**10.4 STANDARD EXTENDED AND PRIVATE CONTEXT GROUPS**

Not Present









---

**GE HEALTHCARE**

**NO.1, YONGCHANG NORTH ROAD  
ECONOMIC & TECHNOLOGICAL DEVELOPMENT ZONE  
FAX: 86-10-67881850  
TELE: 86-10-58068888  
BEIJING, P. R. CHINA 100176**