



Technical Publications

**Direction 5479848-1EN
Revision 1**

Volume Share 7 – Advantage Workstation 4.7 DICOM CONFORMANCE STATEMENT

Copyright© 2015 by General Electric Co.

Do not duplicate



GE Healthcare

THIS PAGE LEFT INTENTIONALLY BLANK

CONFORMANCE STATEMENT OVERVIEW

The Advantage Workstation AW4.7 is a Networked Medical Imaging Console dedicated to Examination Review and Diagnosis on film. The workstation uses DICOM services to import images for possible further analysis or processing and to export images to other DICOM implementations, DICOM printers or DICOM Interchange media. It also uses the DICOM Storage Commitment service to transfer ownership of images to a remote workstation supporting storage commitment such as an archive system. Advantage Workstation is not an archive workstation.

Table 0.1 provides an overview of the network services supported by AW4.7.

Table 0.1 – NETWORK SERVICES

SOP Classes	User of Service (SCU)	Provider of Service (SCP)
Transfer		
Computed Radiography Image Storage	Yes	Yes
Digital X-Ray Image Storage – For Presentation	Yes	Yes
Digital X-Ray Image Storage – For Processing	Yes	Yes
Digital Mammography X-Ray Image Storage – For Presentation	Yes	Yes
Digital Mammography X-Ray Image Storage – For Processing	Yes	Yes
CT Image Storage	Yes	Yes
Ultrasound Multi-frame Image Storage	Yes	Yes
Ultrasound Multi-frame Image Storage (Retired)	Yes	Yes
MR Image Storage	Yes	Yes
Ultrasound Image Storage	Yes	Yes
Ultrasound Image Storage (Retired)	Yes	Yes
Secondary Capture Image Storage	Yes	Yes
Standalone Overlay Storage	No	Yes
X-Ray Angiographic Image Storage	Yes	Yes
X-Ray Radiofluoroscopic Image Storage	Yes	Yes
Nuclear Medicine Image Storage	Yes	Yes
Spatial Registration Storage	Yes	Yes
Basic Text SR	Yes	Yes
Enhanced SR	Yes	Yes
Comprehensive SR	Yes	Yes
Mammography CAD SR	Yes	Yes
Key Object Selection Document	Yes	Yes
X-Ray Radiation Dose SR	Yes	Yes
Encapsulated PDF Storage	Yes	Yes
Positron Emission Tomography Image Storage	Yes	Yes
Standalone Curve Storage	Yes	Yes
Standalone PET Curve Storage	Yes	Yes

RT Image Information Storage	Yes	Yes
RT Structure Set Storage	Yes	Yes
RT Plan Storage	Yes	Yes
GE Private DICOM 3D Object	Yes	Yes
NM Genie Private Data	Yes	Yes
PET Advance Private Data	Yes	Yes
Verification SOP Class	Yes	Yes
Query/Retrieve		
Patient Root Query/Retrieve Information Model – MOVE	No	Yes
Study Root Query/Retrieve Information Model – FIND	Yes	Yes
Study Root Query/Retrieve Information Model – MOVE	Yes	Yes
Print Management		
Basic Film Session SOP Class	Yes	No
Basic Film Box SOP Class	Yes	No
Basic Grayscale Image Box SOP Class	Yes	No
Basic Color Image Box SOP Class	Yes	No
Basic Grayscale Print Management Meta SOP Class	Yes	No
Basic Color Print Management Meta SOP Class	Yes	No
Printer SOP Class	Yes	No
Workflow Management		
Storage Commitment Push Model SOP Class	Yes	No

Option*: This means that this service can be purchased separately

Table 0.2 provides an overview of the Media Storage Application Profiles supported by AW4.7.

Table 0.2 - MEDIA SERVICES

Media Storage Application Profile	Write Files (FSC or FSU)	Read Files (FSR)
Compact Disk - Recordable		
Basic Cardiac X-Ray Angiographic CD-R	Yes: FSC	Yes
Augmented Basic Cardiac X-Ray Angiographic CD-R	Yes: FSC	Yes
General Purpose CD-R	Yes: FSC	Yes
DVD		
General Purpose JPEG DVD	Yes: FSC	Yes
General Purpose JPEG 2000 DVD	No	Yes
USB		
General Purpose JPEG USB	FSC: Yes	Yes
General Purpose JPEG 2000 USB	No	Yes

Option*: This means that this service can be purchased separately

TABLE OF CONTENTS

1. INTRODUCTION	12
1.1 Overview	12
1.2 Overall DICOM Conformance Statement Document Structure	14
1.3 Intended Audience	15
1.4 Scope and Field of Application	15
1.5 Important Remarks	15
1.6 References.....	16
1.7 Definitions.....	17
1.8 Symbols and Abbreviations	18
2. NETWORK CONFORMANCE STATEMENT	22
2.1 Introduction.....	22
2.2 Implementation Model	22
2.3 AE Specifications	29
2.4 Communication Profiles.....	61
2.5 Extensions / Specializations/ Privatizations.....	61
2.6 Configuration	62
2.7 Support of Extended Character Sets	64
2.8 Codes and Controlled Terminology	65
2.9 Security Profiles	65
3. MEDIA STORAGE CONFORMANCE STATEMENT	66
3.1 Introduction.....	66
3.2 Implementation Model	66
3.3 AE Specifications	68
3.4 Augmented and Private Application Profiles.....	76

3.5	Extensions / Specializations / Privatizations.....	79
3.6	Configuration.....	79
3.7	Support of Extended Character Sets	80
4.	STORAGE COMMITMENT PUSH MODEL IMPLEMENTATION	81
4.1	Storage Commitment Push Model Information Object Definition.....	81
5.	BASIC DIRECTORY INFORMATION OBJECT IMPLEMENTATION.....	83
5.1	IOD Module Table.....	83
5.2	Information Module Definitions.....	83
6.	PRINT MANAGEMENT IMPLEMENTATION.....	96
6.1	Introduction.....	96
6.2	Print management SOP class definitions.....	96
7.	SECONDARY CAPTURE INFORMATION OBJECT IMPLEMENTATION.....	116
7.1	Introduction.....	116
7.2	SC Entity-Relationship Model.....	116
7.3	SC-IOD MODULE TABLE.....	118
7.4	SC-INFORMATION MODULE DEFINITIONS.....	118
7.5	SC-PRIVate data dictionary.....	129
8.	ENHANCED SR INFORMATION OBJECT IMPLEMENTATION.....	132
8.1	Introduction.....	132
8.2	ENHANCED SR Entity-Relationship Model	132
8.3	ENHANCED SR-IOD MODULE TABLE	134
8.4	ENHANCED SR -INFORMATION MODULE DEFINITIONS	135
8.5	ENHANCE SR – PRIVATE DATA DICTIONARY	141
8.6	ENHANCE SR – TEMPLATE IDENTIFICATION	141
8.7	ENHANCE SR - Private Coded Entries.....	143
9.	KEY OBJECT SELECTION INFORMATION OBJECT IMPLEMENTATION.....	144

9.1	Introduction.....	144
9.2	KEY OBJECT SELECTION Entity-Relationship Model	144
9.3	KEY OBJECT SELECTION-IOD MODULE TABLE	146
9.4	KEY OBJECT SELECTION -INFORMATION MODULE DEFINITIONS	147
9.5	KEY OBJECT SELECTION – TEMPLATE IDENTIFICATION	154
10.	XA IMAGE INFORMATION OBJECT IMPLEMENTATION	157
10.1	Introduction.....	157
10.2	XA IMAGE Entity-Relationship Model	157
10.3	XA IMAGE-IOD MODULE TABLE	159
10.4	XA Image -INFORMATION MODULE DEFINITIONS.....	161
10.5	XA IMAGE-Private data dictionary.....	171
11.	PRIVATE OBJECT INFORMATION OBJECT IMPLEMENTATION	175
11.1	Introduction.....	175
12.	XA DOWNSCAN INFORMATION OBJECT IMPLEMENTATION	176
12.1	Introduction.....	176
12.2	XA Entity-Relationship Model	176
12.3	XA- DOWNSCAN IOD.....	177
12.4	Implementation Identifying Information	181
13.	TOOL TO MODIFY FIRST AND LAST NAME OF PATIENTS	182
13.1	Introduction.....	182
13.2	Description.....	182
13.3	REAL WORLD ACTIVITY.....	182
13.4	PROCESSING of Iods.....	183
14.	QUERY IMPLEMENTATION.....	190
14.1	ADVANTAGE WORKSTATION Mapping of DICOM Entities.....	190
14.2	Information Model Keys	190

14.3 Private Data Attributes 195

1. INTRODUCTION

1.1 OVERVIEW

This DICOM Conformance Statement is divided into Sections as described below:

Section 1 (Introduction), which describes the overall structure, intent, and references for this Conformance Statement

Section 2 (Network Conformance Statement), which specifies the GEHC equipment compliance to the DICOM requirements for the implementation of Networking features.

Section 3 (Media Storage Conformance Statement), which specifies the GEHC equipment compliance to the DICOM requirements for the implementation of Media Storage features.

Section 4 (Storage Commitment Push Model Implementation) specifies the GEHC equipment compliance to the DICOM requirements for the implementation of Storage Commitment Push feature.

Section 5 (Basic Directory Information Object Implementation) specifies the GEHC equipment compliance to the DICOM requirements for the implementation of Media Storage Directory Information Object.

Section 6 (Network Print SCU Conformance Statement) specifies the GEHC equipment compliance to the DICOM requirements for the implementation of Network Print features.

Section 7 (Network Print Management SOP Class definition) specifies the GEHC equipment compliance to the DICOM requirements for the implementation of Network Print Management SOP Class.

Section 8 (SC Information Object Implementation) specifies the GEHC equipment compliance to the DICOM requirements for the implementation of SC Information Object Implementation feature.

Section 9 (Enhanced SR Object Implementation) specifies the GEHC equipment compliance to the DICOM requirements for the implementation of Enhanced SR Information Object Implementation feature.

Section 10 (Key Object Selection Object Implementation) specifies the GEHC equipment compliance to the DICOM requirements for the implementation of Key Object Selection Information Object Implementation feature.

Section 11 (XA Image Object Implementation) specifies the GEHC equipment compliance to the DICOM requirements for the implementation of XA Image Information Object Implementation feature.

Section 12 (DPO Information Object Implementation) specifies that AW4.7 does not support DPO any more.

Section 13 (XA Downscan Information Object Implementation) specifies the DICOM attributes that are modified when reducing the resolution of GE XA Cardiac images to 512x512.

Section 14 (Tool to modify first and last name of patients) specifies the DICOM attributes that are modified to create anonymous images from existing images.

Section 15 (Query Implementation) specifies the GEHC equipment compliance to the DICOM requirements for the implementation of Network Query feature.

1.2 OVERALL DICOM CONFORMANCE STATEMENT DOCUMENT STRUCTURE

The Documentation Structure of the GEHC DICOM Conformance Statements is shown in the Illustration below.

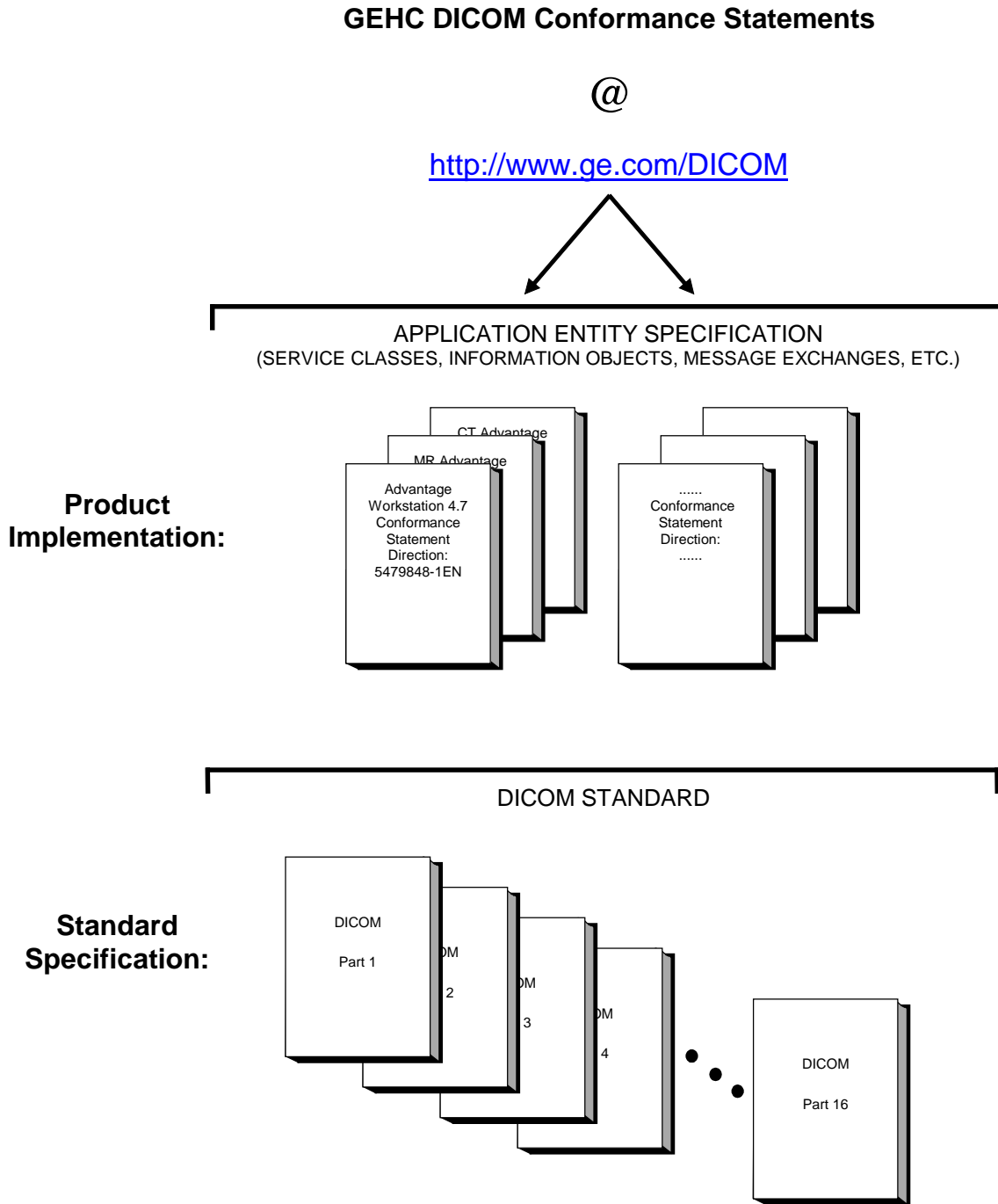

This document specifies the DICOM implementation. It is entitled:

*VS7 – Advantage Workstation 4.7
Conformance Statement for DICOM
Direction 5479848-1EN*

This DICOM Conformance Statement documents the DICOM Conformance Statement and Technical Specification required to interoperate with the GEHC network interface.

The GEHC Conformance Statement, contained in this document, also specifies the Lower Layer communications which it supports (e.g., TCP/IP). However, the Technical Specifications are defined in the DICOM Part 8 standard.

For more information regarding DICOM, copies of the Standard may be obtained on the Internet at <http://medical.nema.org>. Comments on the Standard may be addressed to:

DICOM Secretariat
NEMA
1300 N. 17th Street, Suite 1752
Rosslyn, VA 22209
USA
Phone: +1.703.841.3200

1.3 INTENDED AUDIENCE

The reader of this document is concerned with software design and/or system integration issues. It is assumed that the reader of this document is familiar with the DICOM Standard and with the terminology and concepts which are used in that Standard.

1.4 SCOPE AND FIELD OF APPLICATION

It is the intent of this document to provide an unambiguous specification for GEHC implementations. This specification, called a Conformance Statement, includes a DICOM Conformance Statement and is necessary to ensure proper processing and interpretation of GEHC medical data exchanged using DICOM. The GEHC Conformance Statements are available to the public.

The reader of this DICOM Conformance Statement should be aware that different GEHC devices are capable of using different Information Object Definitions. For example, a GEHC CT Scanner may send images using the CT Information Object, MR Information Object, Secondary Capture Object, etc.

Included in this DICOM Conformance Statement are the Module Definitions which define all data elements used by this GEHC implementation. If the user encounters unspecified private data elements while parsing a GEHC Data Set, the user is well advised to ignore those data elements (per the DICOM standard). Unspecified private data element information is subject to change without notice. If, however, the device is acting as a "full fidelity storage device", it should retain and re-transmit all of the private data elements which are sent by GEHC devices.

1.5 IMPORTANT REMARKS

The use of these DICOM Conformance Statements, in conjunction with the DICOM Standards, is intended to facilitate communication with GE imaging equipment. However, **by itself, it is not sufficient to ensure that inter-operation will be**

successful. The **user (or user's agent)** needs to proceed with caution and address at least four issues:

- **Integration** - The integration of any device into an overall system of interconnected devices goes beyond the scope of standards (DICOM v3.0), and of this introduction and associated DICOM Conformance Statements when interoperability with non-GE equipment is desired. The responsibility to analyze the applications requirements and to design a solution that integrates GE imaging equipment with non-GE systems is the **user's** responsibility and should not be underestimated. The **user** is strongly advised to ensure that such an integration analysis is correctly performed.
- **Validation** - Testing the complete range of possible interactions between any GE device and non-GE devices, before the connection is declared operational, should not be overlooked. Therefore, the **user** should ensure that any non-GE provider accepts full responsibility for all validation required for their connection with GE devices. This includes the accuracy of the image data once it has crossed the interface between the GE imaging equipment and the non-GE device and the stability of the image data for the intended applications.

Such a validation is required before any clinical use (diagnosis and/or treatment) is performed. It applies when images acquired on GE imaging equipment are processed/displayed on a non-GE device, as well as when images acquired on non-GE equipment is processed/displayed on a GE console or workstation.

- **Future Evolution** - GE understands that the DICOM Standard will evolve to meet the user's growing requirements. GE is actively involved in the development of the DICOM Standard. DICOM will incorporate new features and technologies and GE may follow the evolution of the Standard. The GEHC protocol is based on DICOM as specified in each DICOM Conformance Statement. Evolution of the Standard may require changes to devices which have implemented DICOM. **In addition, GE reserves the right to discontinue or make changes to the support of communications features (on its products) described by these DICOM Conformance Statements.** The **user** should ensure that any non-GE provider, which connects with GE devices, also plans for the future evolution of the DICOM Standard. Failure to do so will likely result in the loss of function and/or connectivity as the DICOM Standard changes and GE Products are enhanced to support these changes.
- **Interaction** - It is the sole responsibility of the **non-GE provider** to ensure that communication with the interfaced equipment does not cause degradation of GE imaging equipment performance and/or function.

1.6 REFERENCES

Document	Reference
NEMA PS3	Digital Imaging and Communications in Medicine (DICOM) Standard, available free at http://medical.nema.org/
AW VXTL DCS	Volume Viewer and its applications (Release 12.x) and CardIQ Xpress Process DICOM Conformance Statement (Direction Number: 5543513-1EN)
GENIE DCS	GENIE™ Processing & Review R2.6 DICOM Conformance Statement (Direction number: 2260424-100)
ADV DCS	Advance 4.05 DICOM Conformance Statement (Direction number: 2270669-100 Rev. 0.3)

Informal definitions are provided for the following terms used in this Conformance Statement. The DICOM Standard is the authoritative source for formal definitions of these terms.

Abstract Syntax – the information agreed to be exchanged between applications, generally equivalent to a Service/Object Pair (SOP) Class. Examples : Verification SOP Class, Modality Worklist Information Model Find SOP Class, Computed Radiography Image Storage SOP Class.

Application Entity (AE) – an end point of a DICOM information exchange, including the DICOM network or media interface software; i.e., the software that sends or receives DICOM information objects or messages. A single device may have multiple Application Entities.

Application Entity Title – the externally known name of an *Application Entity*, used to identify a DICOM application to other DICOM applications on the network.

Application Context – the specification of the type of communication used between *Application Entities*. Example: DICOM network protocol.

Association – a network communication channel set up between *Application Entities*.

Attribute – a unit of information in an object definition; a data element identified by a *tag*. The information may be a complex data structure (Sequence), itself composed of lower level data elements. Examples: Patient ID (0010,0020), Accession Number (0008,0050), Photometric Interpretation (0028,0004), Procedure Code Sequence (0008,1032).

Information Object Definition (IOD) – the specified set of *Attributes* that comprise a type of data object; does not represent a specific instance of the data object, but rather a class of similar data objects that have the same properties. The *Attributes* may be specified as Mandatory (Type 1), Required but possibly unknown (Type 2), or Optional (Type 3), and there may be conditions associated with the use of an Attribute (Types 1C and 2C). Examples: MR Image IOD, CT Image IOD, Print Job IOD.

Joint Photographic Experts Group (JPEG) – a set of standardized image compression techniques, available for use by DICOM applications.

Media Application Profile – the specification of DICOM information objects and encoding exchanged on removable media (e.g., CDs)

Module – a set of *Attributes* within an *Information Object Definition* that are logically related to each other. Example: Patient Module includes Patient Name, Patient ID, Patient Birth Date, and Patient Sex.

Negotiation – first phase of *Association* establishment that allows *Application Entities* to agree on the types of data to be exchanged and how that data will be encoded.

Presentation Context – the set of DICOM network services used over an *Association*, as negotiated between *Application Entities*; includes *Abstract Syntaxes* and *Transfer Syntaxes*.

Protocol Data Unit (PDU) – a packet (piece) of a DICOM message sent across the network. Devices must specify the maximum size packet they can receive for DICOM messages.

Security Profile – a set of mechanisms, such as encryption, user authentication, or digital signatures, used by an *Application Entity* to ensure confidentiality, integrity, and/or availability of exchanged DICOM data

Service Class Provider (SCP) – role of an *Application Entity* that provides a DICOM network service; typically, a server that performs operations requested by another *Application Entity (Service Class User)*. Examples: Picture Archiving and Communication System (image storage SCP, and image query/retrieve SCP), Radiology Information System (modality worklist SCP).

Service Class User (SCU) – role of an *Application Entity* that uses a DICOM network service; typically, a client. Examples: imaging modality (image storage SCU, and modality worklist SCU), imaging workstation (image query/retrieve SCU)

Service/Object Pair (SOP) Class – the specification of the network or media transfer (service) of a particular type of data (object); the fundamental unit of DICOM interoperability specification. Examples: Ultrasound Image Storage Service, Basic Grayscale Print Management.

Service/Object Pair (SOP) Instance – an information object; a specific occurrence of information exchanged in a *SOP Class*. Examples: a specific x-ray image.

Tag – a 32-bit identifier for a data element, represented as a pair of four digit hexadecimal numbers, the “group” and the “element”. If the “group” number is odd, the tag is for a private (manufacturer-specific) data element. Examples: (0010,0020) [Patient ID], (07FE,0010) [Pixel Data], (0019,0210) [private data element]

Transfer Syntax – the encoding used for exchange of DICOM information objects and messages. Examples: *JPEG* compressed (images), little endian explicit value representation.

Unique Identifier (UID) – a globally unique “dotted decimal” string that identifies a specific object or a class of objects; an ISO-8824 Object Identifier. Examples: Study Instance UID, SOP Class UID, SOP Instance UID.

Value Representation (VR) – the format type of an individual DICOM data element, such as text, an integer, a person’s name, or a code. DICOM information objects can be transmitted with either explicit identification of the type of each data element (Explicit VR), or without explicit identification (Implicit VR); with Implicit VR, the receiving application must use a DICOM data dictionary to look up the format of each data element.

1.8 SYMBOLS AND ABBREVIATIONS

AE	Application Entity
AET	Application Entity Title
CAD	Computer Aided Detection
CDA	Clinical Document Architecture

CD-R	Compact Disk Recordable
CSE	Customer Service Engineer
CR	Computed Radiography
CT	Computed Tomography
DHCP	Dynamic Host Configuration Protocol
DICOM	Digital Imaging and Communications in Medicine
DIT	Directory Information Tree (LDAP)
DN	Distinguished Name (LDAP)
DNS	Domain Name System
DX	Digital X-ray
FSC	File-Set Creator
FSU	File-Set Updater
FSR	File-Set Reader
GEHC	General Electric Healthcare
GSDf	Grayscale Standard Display Function
GSPS	Grayscale Softcopy Presentation State
HIS	Hospital Information System
HL7	Health Level 7 Standard
IHE	Integrating the Healthcare Enterprise
IOD	Information Object Definition
IPv4	Internet Protocol version 4
IPv6	Internet Protocol version 6
ISO	International Organization for Standards
IO	Intra-oral X-ray
JPEG	Joint Photographic Experts Group
LDAP	Lightweight Directory Access Protocol
LDIF	LDAP Data Interchange Format
LUT	Look-up Table

MAR	Medication Administration Record
MPEG	Moving Picture Experts Group
MG	Mammography (X-ray)
MPPS	Modality Performed Procedure Step
MR	Magnetic Resonance Imaging
MSPS	Modality Scheduled Procedure Step
MTU	Maximum Transmission Unit (IP)
MWL	Modality Worklist
NM	Nuclear Medicine
NTP	Network Time Protocol
O	Optional (Key Attribute)
OP	Ophthalmic Photography
OSI	Open Systems Interconnection
PACS	Picture Archiving and Communication System
PET	Positron Emission Tomography
PDU	Protocol Data Unit
R	Required (Key Attribute)
RDN	Relative Distinguished Name (LDAP)
RF	Radiofluoroscopy
RIS	Radiology Information System
RT	Radiotherapy
SC	Secondary Capture
SCP	Service Class Provider
SCU	Service Class User
SOP	Service-Object Pair
SPS	Scheduled Procedure Step
SR	Structured Reporting
TCP/IP	Transmission Control Protocol/Internet Protocol

GE Healthcare

DIR 5479848-1EN REV 1

U	Unique (Key Attribute)
UL	Upper Layer
US	Ultrasound
VL	Visible Light
VR	Value Representation
XA	X-ray Angiography

2. NETWORK CONFORMANCE STATEMENT

2.1 INTRODUCTION

This section of the DICOM Conformance Statement specifies the AW4.7 compliance to DICOM requirements for **Networking** features.

The Advantage Workstation 4.7 is a Networked Medical Imaging Console dedicated to Examination Review and Diagnosis on film. The workstation uses DICOM services to import images for possible further analysis or processing and to export images to other DICOM implementations, DICOM printers or DICOM Interchange media. It also uses the DICOM Storage Commitment service to transfer ownership of images to a remote workstation supporting storage commitment such as an archive system.

The Advantage Workstation 4.7 has the ability to compose films through the use of an application known as FILMER. The Advantage Workstation 4.7 uses DICOM Print Management Service Class to send images to hard copy printers. The films can then be used for possible further analysis.

The station provides a basis for applications built on top of it. These applications can create specific Information Object Definitions that will be described in the conformance statement of the added applications. The added applications can benefit the network facilities provided by the station.

This DICOM conformance statement refers to the DICOM standard PS3.3 for the description of standard IODs.

This DICOM conformance statement refers to other DICOM conformance statements for formal descriptions of IODs created by added applications:

- GE Private 3D Model Objects are described in the AW VXTL DCS, see 1.6 - References
- GE private DICOM NM images are described in the GENIE DCS, see 1.6 - References
- GE private DICOM PET images are described in the ADV DCS, see 1.6 - References

Note that the format of this section strictly follows the format defined in DICOM Standard PS 3.2 (Conformance). Please refer to that part of the standard while reading this section

2.2 IMPLEMENTATION MODEL

2.2.1 Application Data Flow Diagram

The network application model for the AW4.7 is shown in the following Illustration :

ILLUSTRATION 2-1
AW4.7 NETWORK APPLICATION MODEL AND DATA FLOW DIAGRAM

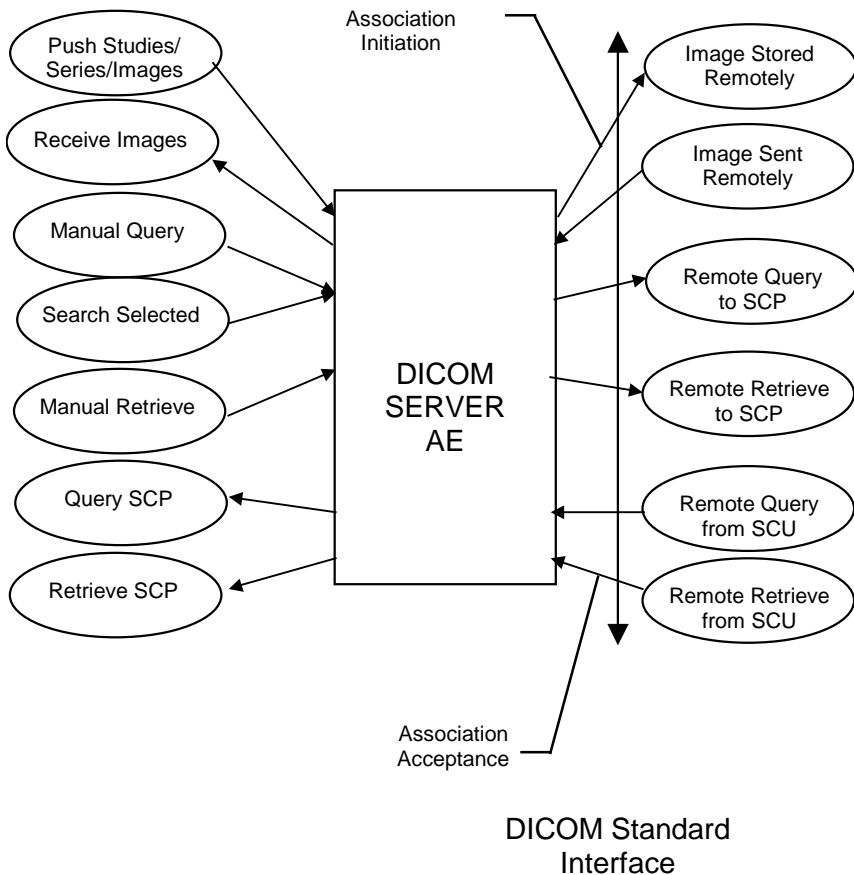

Note: The DICOM SERVER AE plays also the DICOM Verification SOP class as a SCU and SCP. It is not indicated on the illustration above.

The DICOM SERVER Application Entity (AE) is an application that handles DICOM protocol communication. The DICOM SERVER AE is automatically brought up when the Advantage Workstation 4.7 is powered on.

The DICOM SERVER AE is invoked by the following Real World Activities:

- Push Studies/Series/Images.

For this operation, the operator selects:

- some studies, series or images on the console browser and then sends the selected studies, series or images on one or several remote DICOM AE by a drag and drop on the icon that represents the wanted remote DICOM AE.
- a set of studies of the same patient and launches the end of review. A set of series of the patient will be then sent to a set of declared remote DICOM AEs following user defined rules.

The transfer activity is displayed on a specific icon.

The declaration of remote DICOM AE is done through a specific application (known as NETWORK MANAGEMENT).

- Manual Query

For this operation, the operator queries one or a set of remote DICOM databases to obtain a list of data at Study/Series/Image level by clicking on the icon that represents the wanted remote DICOM AE. The query is selective based on criteria described below in the document.

- Search Selected

For this operation, the operator selects a patient and queries one or a set of remote DICOM databases to obtain a list of data corresponding to the selected patient at Study/Series/Image level by clicking on the “Search Selected” icon. The query is selective based on criteria described below in the document.

- Manual Retrieve

Once the remote browser is displayed (Manual Query), the operator can retrieve the SOP Classes supported by the Advantage Workstation 4.7 from the remote DICOM AE. The data can be retrieved at the Study, Series and Image levels.

- Receive images from a Remote DICOM AE

When images are installed in the local database, the local Patient List displays the content of the Advantage Workstation 4.7 local database.

- Remote Query

For this operation, a remote DICOM AE asks to obtain the list of data at Study/Series/Image level.

- Remote Retrieve

For this operation, a remote DICOM AE asks to send data at Patient/Study/Series/Image level from the local AE to another DICOM Remote AE. The remote DICOM AE can ask to move the SOP Classes supported by the Advantage Workstation 4.7 at the Patient/Study/Series/Image level. The Remote DICOM AE shall be declared locally on the Advantage Workstation 4.7. The declaration of remote DICOM AE is done through a specific application (known as NETWORK MANAGEMENT).

ILLUSTRATION 2-2
AW4.7 DICOM STORAGE COMMITMENT AND DATA FLOW DIAGRAM

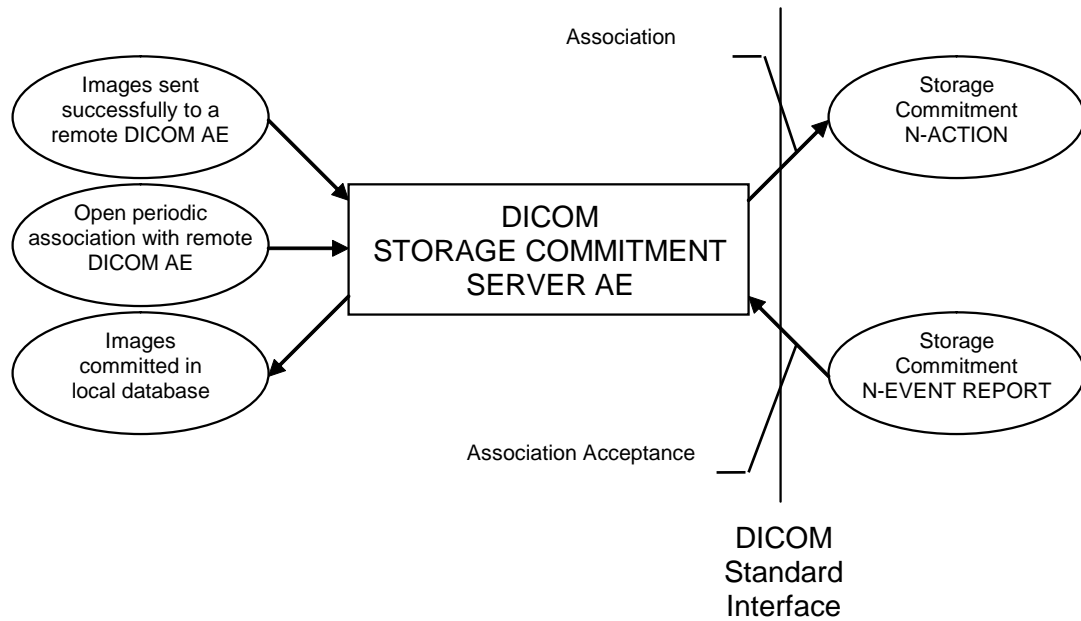

Note: The STORAGE COMMITMENT SERVER AE plays also the DICOM Verification SOP class as SCP. It is not indicated on the illustration above.

The DICOM STORAGE COMMITMENT SERVER AE is invoked by the following Real World Activities:

- Initiate Storage Commitment to a Remote DICOM AE.
- Listen to remote Storage Commitment SCP.
- Open periodic associations.

The Basic and Specific Application models for this device are shown in the following Illustration

DICOM Print SCU Application Entity Model

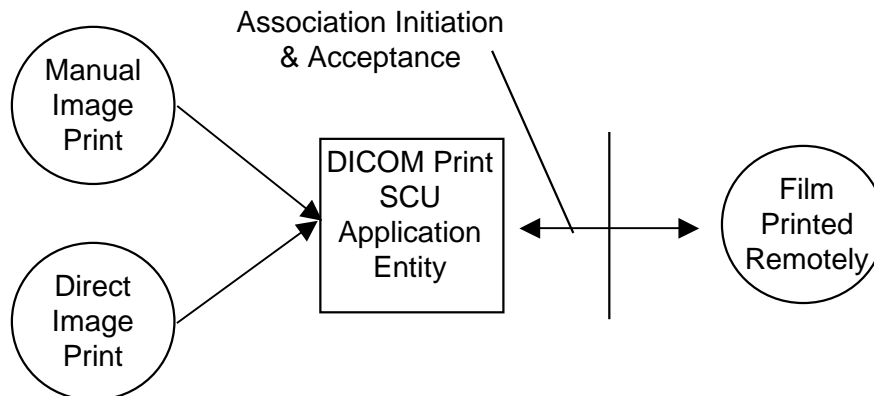

The DICOM Print SCU Application Entity (AE) is an application that handles the DICOM protocol communication with Remote DICOM Printers. The DICOM Print SCU AE is activated when the user requests for a print.

The DICOM Print SCU AE is invoked by the following Real World Activities:

- Manual Image Print

For this operation, the operator uses the *FILMER* application to prepare a layout of images and send the pages to the *PRINT BUILDER*.

- Direct Image Print

For this operation, the operator displays the images in the *VIEWER* and sends the images directly to the *PRINT BUILDER*.

In both cases, the *PRINT BUILDER* receives the “Simple print” request, composes a film then sends the film to the selected Remote DICOM Printer

2.2.2 Functional Definition of AE's

DICOM SERVER AE

The DICOM SERVER AE initiates the following operations:

- Initiate a DICOM association to send DICOM SOP Classes to a remote DICOM AE.
- Initiate a DICOM association to ask for remote patient demographics.
- Initiate a DICOM association to ask for transmitting images from a remote DICOM AE to Advantage Workstation 4.7.
- Initiate a DICOM association to check if an AET is alive (Verification SOP Class as SCU)

The DICOM SERVER AE waits for association requests from Remote AE:

- Answer to DICOM associations requesting patient, study, series or image information..

- Answer to DICOM associations requesting transmission of DICOM SOP Instances from the Advantage Workstation 4.7.
- Answer to DICOM associations transmitting DICOM SOP Classes to be stored on the Advantage Workstation 4.7.
- Answer to DICOM associations transmitting Verification SOP Class to the Advantage Workstation 4.7.

STORAGE COMMITMENT SERVER AE:

The STORAGE COMMITMENT SERVER AE initiates the following operations:

- Initiate a DICOM association to ask for the storage commitment of specific images and wait for a Storage Commitment Notification (N-EVENT-REPORT)
- Initiate a DICOM association and wait for a Storage Commitment Notification (N-EVENT-REPORT)

The STORAGE COMMITMENT SERVER AE waits for association requests from Remote Storage Commitment AE:

- Answer to DICOM associations transmitting Storage Commitment Notification (N-EVENT-REPORT)

DICOM PRINT SCU AE:

The DICOM Print SCU AE supports the following functions:

- Access to pixel data
- Initiate a DICOM association to send DICOM SOP Classes (corresponding to the DICOM Print Management service class) to a remote DICOM Printer

2.2.3 Sequencing of Real-World Activities

DICOM SERVER AE:

Not applicable.

STORAGE COMMITMENT SERVER AE:

This sequence is only applicable for Remote AE where Storage Commitment Option is allowed in Network Manager.

1. The user selects the images and sends them to a remote host.
2. If the remote DICOM AE is associated with a Storage Commitment Provider AE and if the images are successfully sent to the DICOM AE, then a N-ACTION-RQ request is sent automatically to the associated Storage Commitment Provider AE. The Storage

Commitment Provider AE can be configured independently from the remote DICOM AE with network address, port and AE title.

3. Waits for N-ACTION-RSP from a remote Storage Commitment Provider AE.
4. On reception of failure in N-ACTION-RSP, the Storage Commitment AE logs the error, displays a pop-up and stops.
5. On reception of success, Storage Commitment AE is ready to receive at any time from Storage Commitment Provider the N-EVENT-REPORT-RQ notification.
6. On reception of a successful N-EVENT-REPORT-RQ notification from Storage Commitment Provider, the images are flagged as committed in the database.
7. The Storage Commitment AE sends a N-EVENT-REPORT-RSP to the Storage Commitment Provider
8. The Storage Commitment AE opens periodic association with all the DICOM AE that have been declared as Storage Commitment Provider on the station. The time between these associations is configurable.

DICOM PRINT SCU AE:

The user selects the remote DICOM Printer from Print Builder Graphical User Interface.

1. The images to be printed shall be dragged and drop into the FILMER application either manually or automatically.
2. The PRINT BUILDER receives the “Simple print” request, composes a film then activates the DICOM Print SCU AE that initiates the following actions.
3. The PRINT BUILDER Initiates a DICOM association and selects a Presentation Context.
4. N-GETs printer status from the Printer SOP Instance
 - a. If the Printer Status is FAILURE
 - i. The failure is displayed to the user
 - ii. The association is aborted
 - b. If the Printer Status is a warning
 - i. Just report the warning status and continue
 - c. Else (Ok status)
 - i. The Print goes on
 - d. Endif
5. N-CREATEs a Basic Film Session SOP Instance
6. N-CREATEs a Basic Film Box SOP Instance for the current film
7. N-SETs the Basic Film Box SOP Instance with the Image Box SOP Instance for each image on the film
8. N-ACTIONs on the Basic Film Box SOP Instance
9. N-DELETEs on the Basic Film Box SOP Instance
10. Releases the DICOM association after printing is successful or failure has been signaled to the user

2.3 AE SPECIFICATIONS

2.3.1 DICOM SERVER AE Specification

The DICOM SERVER Application Entity provides Standard Conformance to the following DICOM SOP Classes as an **SCU** and/or as an **SCP**:

SOP Class Name	SOP Class UID	SCU	SCP
Verification SOP Class	1.2.840.10008.1.1	Yes	Yes
Computed Radiography Image Storage	1.2.840.10008.5.1.4.1.1.1	Yes	Yes
Digital X-Ray Image Storage - For Presentation	1.2.840.10008.5.1.4.1.1.1.1	Yes	Yes
Digital X-Ray Image Storage - For Processing	1.2.840.10008.5.1.4.1.1.1.1.1	Yes	Yes
Digital Mammography Image Storage - For Presentation	1.2.840.10008.5.1.4.1.1.1.2	Yes	Yes
Digital Mammography Image Storage - For Processing	1.2.840.10008.5.1.4.1.1.1.2.1	Yes	Yes
CT Image Storage	1.2.840.10008.5.1.4.1.1.2	Yes	Yes
Ultrasound Multi-frame Image Storage	1.2.840.10008.5.1.4.1.1.3.1	Yes	Yes
Ultrasound Multi-frame Image Storage (Retired)	1.2.840.10008.5.1.4.1.1.3	Yes	Yes
MR Image Storage	1.2.840.10008.5.1.4.1.1.4	Yes	Yes
Ultrasound Image Storage	1.2.840.10008.5.1.4.1.1.6.1	Yes	Yes
Ultrasound Image Storage (Retired)	1.2.840.10008.5.1.4.1.1.6	Yes	Yes
Secondary Capture Image Storage	1.2.840.10008.5.1.4.1.1.7	Yes	Yes
Standalone Overlay Storage	1.2.840.10008.5.1.4.1.1.8	No	Yes
X-Ray Angiographic Image Storage	1.2.840.10008.5.1.4.1.1.12.1	Yes	Yes
X-Ray Radiofluoroscopic Image Storage	1.2.840.10008.5.1.4.1.1.12.2	Yes	Yes
Nuclear Medicine Image Storage	1.2.840.10008.5.1.4.1.1.20	Yes	Yes
Spatial Registration Storage	1.2.840.10008.5.1.4.1.1.66.1	Yes	Yes
Basic Text SR Storage	1.2.840.10008.5.1.4.1.1.88.11	Yes	Yes
Enhanced SR Storage	1.2.840.10008.5.1.4.1.1.88.22	Yes	Yes
Comprehensive SR	1.2.840.10008.5.1.4.1.1.88.33	Yes	Yes
Mammography CAD SR	1.2.840.10008.5.1.4.1.1.88.50	Yes	Yes
Key Object Selection Document Storage	1.2.840.10008.5.1.4.1.1.88.59	Yes	Yes
X-Ray Radiation Dose SR	1.2.840.10008.5.1.4.1.1.88.67	Yes	Yes

Encapsulated PDF Storage	1.2.840.10008.5.1.4.1.1.104.1	Yes	Yes
Positron Emission Tomography Image Storage	1.2.840.10008.5.1.4.1.1.128	Yes	Yes
Standalone Curve Storage	1.2.840.10008.5.1.4.1.1.9	Yes	Yes
Standalone PET Curve Storage	1.2.840.10008.5.1.4.1.1.129	Yes	Yes
RT Image Information Storage	1.2.840.10008.5.1.4.1.1.481.1	Yes	Yes
RT Structure Set Storage	1.2.840.10008.5.1.4.1.1.481.3	Yes	Yes
RT Plan Storage	1.2.840.10008.5.1.4.1.1.481.5	Yes	Yes
GE Private DICOM 3D Object	1.2.840.113619.4.26	Yes	Yes
PET Advance Private Data	1.2.840.113619.4.30	Yes	Yes
NM Genie Private Data	1.2.840.113619.4.27	Yes	Yes
Patient Root Query/Retrieve Information Model - MOVE	1.2.840.10008.5.1.4.1.2.1.2	No	Yes
Study Root Query/Retrieve Information Model - FIND	1.2.840.10008.5.1.4.1.2.2.1	Yes	Yes
Study Root Query/Retrieve Information Model - MOVE	1.2.840.10008.5.1.4.1.2.2.2	Yes	Yes

Note: C-FIND is done using Study Root Information Model.

Note: Grayscale Softcopy Presentation State Storage (1.2.840.10008.5.1.4.1.1.11.1) and Blending Softcopy Presentation State Storage (1.2.840.10008.5.1.4.1.1.11.4) abstract syntax is received on network / read from media and some properties (image number, date/time, description and creator's name) are displayed in the BROWSER but the basic Advantage Workstation 4.7 applications cannot display this object in a meaningful way (only black image is visible) and objects content is not taken into account while displaying the referenced images.

2.3.1.1 Association Establishment Policies

2.3.1.1.1 General

The DICOM Application Context Name (ACN), which is always proposed, is:

Application Context Name	1.2.840.10008.3.1.1.1
---------------------------------	------------------------------

The maximum length PDU negotiation is included in all association establishment requests.

The maximum length PDU receive size for the DICOM SERVER AE is:

Maximum Length PDU	64234 Bytes / Configurable
---------------------------	-----------------------------------

Note: The SOP Class Extended Negotiation is not supported.

Note: The user information Items sent by this product are:

- Maximum PDU Length
- Implementation UID

2.3.1.1.2 Number of Associations

The DICOM SERVER AE will initiate only one DICOM association at a time to perform a DICOM store operation as a SCU to a Remote Host AE.

The DICOM SERVER AE will initiate only one DICOM association at a time to perform a DICOM Query/Retrieve operation as a SCU with a Remote Host AE.

The DICOM SERVER AE can have a maximum of 4 open DICOM associations at a time to perform a DICOM operation as a SCP.

2.3.1.1.3 Asynchronous Nature

Asynchronous mode is not supported. All operations will be performed synchronously.

2.3.1.1.4 Implementation Identifying Information

The Implementation UID for this DICOM Implementation is:

Advantage Workstation 4.7 Implementation UID	1.2.840.113619.6.350
Advantage Workstation 4.7 Implementation Version Name	The Implementation Version Name represents the canonical version of the AW, for example: AW4_7_01_186_HEL

2.3.1.2 Association Initiation Policy

When the DICOM SERVER AE Application Entity initiates an Association for any Real-World Activity, it will propose the Presentation Contexts for all Real-World Activities; i.e., there is only a single, comprehensive Presentation Context Negotiation proposed for the AE.

The DICOM SERVER AE proposes the transfer syntaxes “Uncompressed Transfer Group” of **Table 2.3–1** in each Presentation Context.

2.3.1.2.1 Real-World Activity: Push Studies/Series/Images to Remote AE

2.3.1.2.1.1 Associated Real-World Activity

The operator can select in the BROWSER one or several Studies (or Series/Images) to be sent. Then, the user can either drag and drop the selection on the icon representing then Remote DICOM AE, or click on the “Push” icon and select a Remote DICOM AE in the LIST OF REMOTE HOST.

The operator can select in the BROWSER one or several studies of the same patient and launch the End of review tool. A set of series of the patient will be then sent to a set of declared remote DICOM AEs following user defined rules.

This operation will cause the following actions:

- The DICOM SERVER AE will initiate a DICOM association, negotiate with the Remote AE an appropriate Abstract and Transfer Syntax.
- The DICOM SERVER AE will emit a C-STORE command to send the image, if the negotiation is successful.

2.3.1.2.1.2 Association Initiation Policy

The DICOM SERVER AE initiates a new association with a remote DICOM AE for each job selected by the operator. The operator can select to push to a remote DICOM AE:

- a study, a series, an image or
- a set of several images that belong to the same patient through the end review paradigm

This Real World Activity can be activated by two user interface events:

- Push manually Studies/Series/Images to a remote DICOM AE
- Push the selection or a subset of the selection to a set of remote DICOM AEs through the end review paradigm

2.3.1.2.1.3 Proposed Presentation Context Table

The following table shows the transfer syntax groups that are referred from the Presentation Context Tables. If a group is referred all its transfer syntaxes are proposed or any can be accepted during handshake.

Table 2.3–1 Transfer Syntax Groups table

Transfer Syntax Group	Transfer Syntax	
Name	Name List	UID List
Uncompressed Transfer Group	Implicit VR Little Endian	1.2.840.10008.1.2
	Explicit VR Little Endian	1.2.840.10008.1.2.1
	Explicit VR Big Endian	1.2.840.10008.1.2.2

Compressed Transfer Group	JPEG Lossless HIER 14	1.2.840.10008.1.2.4.70
	JPEG 2000 Lossless ONLY	1.2.840.10008.1.2.4.90
	JPEG Baseline (Process 1)	1.2.840.10008.1.2.4.50
	JPEG Extended (Process 2 & 4)	1.2.840.10008.1.2.4.51
	JPEG 2000	1.2.840.10008.1.2.4.91

Note: The usage of the different transfer syntax groups are defined later in different sections of the document.

Note: The **Compressed Transfer Group** is turned off by default and can be enabled by GE Field Engineer.

The following table shows the proposed presentation contexts for the DICOM Server AE after Real-World Activity “Push” Operation has been performed.

Table 2.3–2 Presentation Context Table – Proposed by DICOM SERVER AE for Push activity

Abstract Syntax		Transfer Syntax Group	Role	Extended Negotiation
Name	UID	Name		
Computed Radiography Image Storage	1.2.840.10008.5.1.4.1.1.1	Uncompressed Transfer Group	SCU	None
CT Image Storage	1.2.840.10008.5.1.4.1.1.2	Uncompressed Transfer Group	SCU	None
MR Image Storage	1.2.840.10008.5.1.4.1.1.4	Uncompressed Transfer Group	SCU	None
X-Ray Angiographic Image Storage	1.2.840.10008.5.1.4.1.1.12.1	Uncompressed Transfer Group	SCU	None
X-Ray Radiofluoroscopic Image Storage	1.2.840.10008.5.1.4.1.1.12.2	Uncompressed Transfer Group	SCU	None
Secondary Capture Image Storage	1.2.840.10008.5.1.4.1.1.7	Uncompressed Transfer Group	SCU	None
Digital X-Ray Image Storage - For Presentation	1.2.840.10008.5.1.4.1.1.1.1	Uncompressed Transfer Group	SCU	None
Digital X-Ray Image Storage - For Processing	1.2.840.10008.5.1.4.1.1.1.1.1	Uncompressed Transfer Group	SCU	None
Digital Mammography X-Ray Image Storage - For Presentation	1.2.840.10008.5.1.4.1.1.1.2	Uncompressed Transfer Group	SCU	None
Digital Mammography X-Ray Image Storage - For Processing	1.2.840.10008.5.1.4.1.1.1.2.1	Uncompressed Transfer Group	SCU	None
Nuclear Medicine Image Storage	1.2.840.10008.5.1.4.1.1.20	Uncompressed Transfer Group	SCU	None
Standalone Curve Storage	1.2.840.10008.5.1.4.1.1.9	Uncompressed Transfer Group	SCU	None
Positron Emission Tomography Image Storage	1.2.840.10008.5.1.4.1.1.128	Uncompressed Transfer Group	SCU	None

**VS7 – ADVANTAGE WORKSTATION 4.7
DICOM CONFORMANCE STATEMENT**

GE Healthcare

DIR 5479848-1EN REV 1

Standalone PET Curve Storage	1.2.840.10008.5.1.4.1.1.129	Uncompressed Transfer Group	SCU	None
RT Image Information Storage	1.2.840.10008.5.1.4.1.1.481.1	Uncompressed Transfer Group	SCU	None
RT Structure Set Information Storage	1.2.840.10008.5.1.4.1.1.481.3	Uncompressed Transfer Group	SCU	None
RT Plan Information Storage	1.2.840.10008.5.1.4.1.1.481.5	Uncompressed Transfer Group	SCU	None
NM Genie Private Data	1.2.840.113619.4.27	Uncompressed Transfer Group	SCU	None
PET Advance Private Data	1.2.840.113619.4.30	Uncompressed Transfer Group	SCU	None
GE Private DICOM 3D Object	1.2.840.113619.4.26	Uncompressed Transfer Group	SCU	None
Ultrasound Image Storage	1.2.840.10008.5.1.4.1.1.6.1	Uncompressed Transfer Group	SCU	None
Ultrasound Multi-frame Image Storage	1.2.840.10008.5.1.4.1.1.3.1	Uncompressed Transfer Group	SCU	None
Ultrasound Image Storage (Retired)	1.2.840.10008.5.1.4.1.1.6	Uncompressed Transfer Group	SCU	None
Ultrasound Multi-frame Image Storage (Retired)	1.2.840.10008.5.1.4.1.1.3	Uncompressed Transfer Group	SCU	None
Basic Text SR	1.2.840.10008.5.1.4.1.1.88.11	Uncompressed Transfer Group	SCU	None
Enhanced SR	1.2.840.10008.5.1.4.1.1.88.22	Uncompressed Transfer Group	SCU	None
Comprehensive SR	1.2.840.10008.5.1.4.1.1.88.33	Uncompressed Transfer Group	SCU	None
Mammography CAD SR	1.2.840.10008.5.1.4.1.1.88.50	Uncompressed Transfer Group	SCU	None
Spatial Registration Storage	1.2.840.10008.5.1.4.1.1.66.1	Uncompressed Transfer Group	SCU	None
Key Object Selection Document Storage	1.2.840.10008.5.1.4.1.1.88.59	Uncompressed Transfer Group	SCU	None
X-Ray Radiation Dose SR Storage	1.2.840.10008.5.1.4.1.1.88.67	Uncompressed Transfer Group	SCU	None
Encapsulated PDF Storage	1.2.840.10008.5.1.4.1.1.104.1	Uncompressed Transfer Group	SCU	None

Note: Grayscale Softcopy Presentation State Storage (1.2.840.10008.5.1.4.1.1.11.1) and Blending Softcopy Presentation State Storage (1.2.840.10008.5.1.4.1.1.11.4) abstract syntax is received on network / read from media and some properties (image number, date/time, description and creator's name) are displayed in the BROWSER but the basic Advantage Workstation 4.7 applications cannot display this object in a meaningful way (only black image is visible) and objects content is not taken into account while displaying the referenced images.

Note: See **Table 2.3–1** for the list of transfer syntaxes available for the Transfer Syntax Group.

2.3.1.2.1.3.1 SOP Specific DICOM Conformance Statement for Image Storage SOP Classes

Following are the status codes that are more specifically processed when receiving messages from a **Storage** SCP equipment :

Service Status	Status Code	Further Meaning	Application Behavior When Receiving Status Code
Failure	A700-A7FF	Refused: Out of resources	Upon receiving a C-STORE confirmation containing any status that is not Success or Refused, this implementation will consider the current request to be a failure and will terminate the association except if the C-STORE is invoked from a C-MOVE SCP. In this case it will continue to attempt to send the remaining images in the request on the same association.
	A900-A9FF	Error: Data Set does not match SOP Class	
	C000-CFFF	Error: Cannot Understand	
	0122	SOP Class Not Supported	
Warning	B000	Coercion of Data Elements	Ignored.
	B006	Elements Discarded	
	B007	Data Set does not match SOP Class	
Success	0000		This implementation will perform the next C-STORE operation. The association will be maintained if possible.
*	*	Any other status code.	Upon receiving a C-STORE confirmation containing a Refused status, this implementation will terminate the association.

This implementation can perform multiple C-STORE operations over a single association.

Each C-STORE operation supports an “Association Timer”. This timer starts when the association request is sent and stops when the association is established. Default time-out is 30 seconds.

Each C-STORE operation supports an “Operation Inactivity Timer”. This timer starts when a C-STORE request is emitted and is reset each time a C-STORE response has been received, or when subsequent C-STORE are received. Default time-out is 180 seconds.

If any of the two timers mentioned above expires, the connection is aborted and the operation is considered as failed.

2.3.1.2.1.3.2 SOP Specific DICOM Conformance Statement for the Grayscale and Blending Softcopy Presentation State Storage SOP Class

The DICOM SERVER AE does not support creation and application of the transformations defined by Grayscale and Blending Softcopy Presentation State Storage SOP Instances.

The objects are just received/sent on network and read from/written on media. Some properties (image number, date/time, description and creator’s name) are displayed in the BROWSER but the basic Advantage Workstation 4.7 applications cannot display this object in a meaningful way (only black image is visible) and objects content is not taken into account while displaying the referenced images.

2.3.1.2.2 Real-World Activity: Manual Query

2.3.1.2.2.1 Associated Real-World Activity

The operator queries a Remote database or a set of Remote databases by clicking on the corresponding icon. A new BROWSER (known as the REMOTE BROWSER) appears on the screen(s) upon successful query.

The “Query” operation will cause the DICOM Server AE to initiate an association to the selected Remote AE. Once a list of Study/Series/Image has been queried, the operator can invoke the “Retrieve” operation by choosing “Get Exam” or “Get Series” or “Get Image” from the displayed REMOTE BROWSER (drag on drop the selection on the icon representing the Advantage Workstation 4.7 or click on the “Get” icon).

Note: The SCU will cancel the C-FIND by issuing a C-FIND-CANCEL request after the reception of 500 studies. This number is configurable by the GE Field Engineer.

Note: The REMOTE BROWSER is able to display up to 1500 studies at a time when querying a set of remote DICOM AEs. This number is configurable by the GE Field Engineer.

2.3.1.2.2.2 Association Initiation Policy

The DICOM SERVER AE initiates a new association for querying Study Folders (or Series/Images) on a remote DICOM AE. This association corresponds to one Real World Activity.

2.3.1.2.2.3 Proposed Presentation Context Table

Presentation Context Table – Proposed by DICOM SERVER AE for Activity Manual Query				
Abstract Syntax		Transfer Syntax Group	Role	Extended Negotiation
Name	UID	Name		
Study Root Query/Retrieve Information Model - FIND	1.2.840.10008.5.1.4.1.2.2.1	Uncompressed Transfer Group	SCU	None

Note: See **Table 2.3–1** for the list of transfer syntaxes available for the Transfer Syntax Group.

2.3.1.2.2.3.1 SOP Specific DICOM Conformance Statement for C-FIND-SCU

DICOM Server AE is able to generate C-Find-Cancel, see the table below.

Following are the status codes that are more specifically processed when receiving messages from a C-FIND SCP equipment :

Service Status	Status Code	Further Meaning	Application Behavior When Receiving Status Code
Failure	A700	Refused: Out of resources	Upon receiving a C-FIND response with any failure status, this implementation will consider the current request to be a failure and will terminate the association.
	A900	Error: Identifier does not match SOP Class	
	C000-CFFF	Error: Unable to process	
	0122	SOP Class Not Supported	
Cancel	FE00	Matching terminated due to cancel	Displays a message that the query was stopped.
Success	0000	Matching is complete - No final identifier is supplied	Results displayed in the Remote Patient List. If the query is done on Study level the Patient List automatically selects the first study and continues the query on series level. If this is finished the first series is automatically selected and query is continued on image level. If study level query results in more than 500 studies the patient list displays a message about this limitation and cancels the query.
Pending	FF00	Matches are continuing - Current Match is supplied and any Optional Keys were supported in the same manner as Required Keys.	Processed.
	FF01	Matches are continuing - Warning that one or more Optional Keys were not supported for existence and/or matching for this Identifier	

*	*	Any other status code.	
---	---	------------------------	--

The C-FIND SCU will only perform hierarchical query (No extended negotiation supported)

Each C-FIND SCU supports an “Association Timer” and an “Operation Inactivity Timer”. These timers are defaulted to 30 and 90 seconds.

The DICOM SERVER AE will parse each matching C-FIND-RSP reply and will abort the association if an entry does not contain a valid dataset.

2.3.1.2.2.3.1.1 Patient name format definition

DICOM SERVER AE is able to send the Patient Name in following wildcard matching formats:

- “PATIENT_NAME” if IS filter is selected in filter manager for patient name
- “PATIENT_NAME”* if BEGINS filter is selected or Search Selected feature is used
- “*PATIENT_NAME*” if CONTAINS filter is selected

Where “PATIENT_NAME” may contain the following ASCII characters:

- a-z, A-Z, 1-9
- `~!@#%&()-_+[]{}|:;”’<>.,?/

If the query has no result at patient level and the Field Engineer configured the station to try an automatic second query DICOM SERVER AE will replace ‘^’ and ‘ ‘ characters in the patient name with ‘*’ or ‘?’ depending on the configuration and issue a second query.

2.3.1.2.3 Real-World Activity: Search Selected Query

This activity uses the “Manual Query” real-world activity. For detailed information refer to the previous section. Only the differences are detailed here.

2.3.1.2.3.1 Associated Real-World Activity

The operator queries a Remote database or a set of Remote databases by clicking on the “*Search Selected*” icon. A new BROWSER (known as the REMOTE BROWSER) appears on the screen(s) with the patient name and patient id automatically filled in based on the information of the selected patient.

Due to limitations the Patient’s Name and Id are cut to the longest starting ASCII substring. For example “Kovács^Olivér” is cut to “Kov” since “á” is not an ASCII character. The Specific Character Set (0008,0005) field is set to the DICOM original Specific Character Set information.

See Patient name format definition in 2.3.1.2.2.3.1.1 for more information.

See status management in 2.3.1.2.2.3.1 for more information.

2.3.1.2.4 Real-World Activity: Manual Retrieve

2.3.1.2.4.1 Associated Real-World Activity

The operator then has to perform the Real-World activity “*Query*” to get a list of Studies, Series and Images. Once the list of list of Studies, Series and Images is retrieved, the operator can invoke the “*Retrieve*” operation by choosing “*Get Exam*” or “*Get Series*” or “*Get Image*” from the displayed REMOTE BROWSER (drag on drop the selection on the icon representing the Advantage Workstation 4.7 or click on the “*Get*” icon).

2.3.1.2.4.2 Association Initiation Policy

The DICOM SERVER AE initiates a new association for retrieving Studies, Series and Images on a remote DICOM AE. This association corresponds to one Real World Activity.

2.3.1.2.4.3 Proposed Presentation Context Table

When the remote DICOM AE is declared as a Study Root Provider or the invoked operation is “*Get Study*” or “*Get Series*” or “*Get Image*”, the presentation context shown in following table is proposed.

Presentation Context Table – Proposed by DICOM SERVER AE for Activity Manual Retrieve					
Abstract Syntax		Transfer Syntax Group		Role	Extended Negotiation
Name	UID	Name			
Study Root Query/Retrieve Information Model - MOVE	1.2.840.10008.5.1.4.1.2.2.2	Uncompressed Transfer Group		SCU	None

Note: See **Table 2.3–1** for the list of transfer syntaxes available for the Transfer Syntax Group.

2.3.1.2.4.3.1 SOP Specific DICOM Conformance Statement for the Study Root Query/Retrieve Information Model – MOVE SOP Classes

When the operator starts a *Move* operation at any level (Study, Series, Image) the DICOM Server AE will initiate a C-MOVE-RQ request to the Remote AE with the DICOM Server AE as the Destination AE. The Storage SCP (“*Receive Images from Remote AE*”) will handle the incoming images.

Each C-MOVE SCU supports an “*Association Timer*” and an “*Operation Inactivity Timer*”. These timers are defaulted to 30 and 600 seconds. DICOM Server AE does not support C-MOVE Cancel operation.

Following are the status codes that are more specifically processed when receiving messages from a C-MOVE SCP equipment :

Service Status	Status Code	Further Meaning	Application Behavior When Receiving Status Code
Failure	A701	Refused: Out of resources - Unable to calculate number of matches	Upon receiving a C-MOVE response with any failure status this implementation will consider the current request to be a failure and will terminate the association.
	A702	Refused: Out of resources - Unable to perform sub-operations	
	A801	Refused: Move Destination Unknown	
	A900	Error: Identifier does not match SOP Class	
	C000-CFFF	Error: Unable to process	
	0122	SOP Class Not Supported	
Cancel	FE00	Sub-operations terminated due to a Cancel indication	This implementation will release the association.
Warning	B000	Sub-operations Complete - One or more Failures.	Processed.
Success	0000	Sub-operations Complete - No Failure.	This implementation will perform the next C-MOVE operation.
Pending	FF00	Sub-operations are continuing -	Processed.
*	*	Any other status code.	Upon receiving a C-MOVE response with any other status this implementation will consider the current request to be a failure and will terminate the association.

2.3.1.2.5 Real-World Activity: Manual DICOM Ping

2.3.1.2.5.1 Associated Real-World Activity

The service engineer would like to check whether a Remote AE is up and DICOM services are available. For this operation a terminal is opened and “sendecho” command is typed. The command line tool asks for local and remote Application Entity Title, remote IP address and port then checks the status of the remote DICOM Verification SOP class.

2.3.1.2.5.2 Association Initiation Policy

The DICOM SERVER AE initiates a new association for checking the status of the Remote AE. This association corresponds to one Real World Activity.

2.3.1.2.5.3 Proposed Presentation Context Table

The DICOM SERVER AE proposes the following presentation context table.

Presentation Context Table – Proposed by DICOM SERVER AE for Activity Manual DICOM Ping				
Abstract Syntax		Transfer Syntax Group	Role	Extended Negotiation
Name	UID	Name		
Verification	1.2.840.10008.1.1	Uncompressed Transfer Group	SCU	None

Note: See **Table 2.3–1** for the list of transfer syntaxes available for the Transfer Syntax Group.

2.3.1.3 Association Acceptance Policy

The DICOM SERVER AE refuses the association if they are too many open connections.

There are two DICOM Acceptance Policies that is configurable by GE Field Engineer:

- **Strict DICOM Acceptance Policy**
 In this mode only the DICOM hosts that are configured on AW4.7 are accepted.
- **Free DICOM Acceptance Policy**
 In this mode all DICOM hosts are accepted for Query and Store operations. Retrieve operation always requires the destination DICOM host to be configured on AW4.7.

2.3.1.3.1 Real-World Activity: Receive Images from Remote AE

This AE is indefinitely listening for associations. No operator action is required to receive an image.

2.3.1.3.1.1 Associated Real-World Activity

The Real-World Activity associated with the Receive Images operation is the storage of the images on the disk drive of the Advantage Workstation 4.7 and the declaration of the images in the database of the same station.

2.3.1.3.1.2 Presentation Context Table

Acceptable Presentation Contexts for DICOM Server AE and Real-World Activity Receive Images from Remote AE.

Presentation Context Table – Proposed by DICOM SERVER AE for Activity Receive Images from Remote AE			
Abstract Syntax	Transfer Syntax Group	Role	Extended

**VS7 – ADVANTAGE WORKSTATION 4.7
DICOM CONFORMANCE STATEMENT**

GE Healthcare

DIR 5479848-1EN REV 1

Name	UID	Name		Negotiation
Computed Radiography Image Storage	1.2.840.10008.5.1.4.1.1.1	Uncompressed Transfer Group	SCP	None
CT Image Storage	1.2.840.10008.5.1.4.1.1.2			
MR Image Storage	1.2.840.10008.5.1.4.1.1.4	Compressed Transfer Group		
X-Ray Angiographic Image Storage	1.2.840.10008.5.1.4.1.1.12.1			
X-Ray Radiofluoroscopic Image Storage	1.2.840.10008.5.1.4.1.1.2			
Secondary Capture Image Storage	1.2.840.10008.5.1.4.1.1.2			
Digital X-Ray Image Storage - For Presentation	1.2.840.10008.5.1.4.1.1.1.1			
Digital X-Ray Image Storage - For Processing	1.2.840.10008.5.1.4.1.1.1.1.1			
Digital Mammography X-Ray Image Storage - For Presentation	1.2.840.10008.5.1.4.1.1.1.2			
Digital Mammography X-Ray Image Storage - For Processing	1.2.840.10008.5.1.4.1.1.1.2.1			
Nuclear Medicine Image Storage	1.2.840.10008.5.1.4.1.1.20			
Standalone Curve Storage	1.2.840.10008.5.1.4.1.1.9			
Positron Emission Tomography Image Storage	1.2.840.10008.5.1.4.1.1.128			
Standalone PET Curve Storage	1.2.840.10008.5.1.4.1.1.129			
RT Image Information Storage	1.2.840.10008.5.1.4.1.1.481.1			
RT Structure Set Information Storage	1.2.840.10008.5.1.4.1.1.481.3			
RT Plan Information Storage	1.2.840.10008.5.1.4.1.1.481.5			
NM Genie Private Data	1.2.840.113619.4.27			
PET Advance Private Data	1.2.840.113619.4.30			
GE Private DICOM 3D Object	1.2.840.113619.4.26			
Ultrasound Image Storage	1.2.840.10008.5.1.4.1.1.2			
Ultrasound Multi-frame Image Storage	1.2.840.10008.5.1.4.1.1.2			
Ultrasound Image Storage (Retired)	1.2.840.10008.5.1.4.1.1.6			
Basic Text SR	1.2.840.10008.5.1.4.1.1.88.11			
Enhanced SR	1.2.840.10008.5.1.4.1.1.88.22			
Comprehensive SR	1.2.840.10008.5.1.4.1.1.88.33			
Mammography CAD SR	1.2.840.10008.5.1.4.1.1.88.50			

Spatial Registration Storage	1.2.840.10008.5.1.4.1.1.66.1			
Key Object Selection Document Storage	1.2.840.10008.5.1.4.1.1.88.59			
X-Ray Radiation Dose SR Storage	1.2.840.10008.5.1.4.1.1.88.67			
Encapsulated PDF Storage	1.2.840.10008.5.1.4.1.1.104.1			

Note: Grayscale Softcopy Presentation State Storage (1.2.840.10008.5.1.4.1.1.11.1) and Blending Softcopy Presentation State Storage (1.2.840.10008.5.1.4.1.1.11.4) abstract syntax is received on network / read from media and some properties (image number, date/time, description and creator’s name) are displayed in the BROWSER but the basic Advantage Workstation 4.7 applications cannot display this object in a meaningful way (only black image is visible) and objects content is not taken into account while displaying the referenced images.

Note: See **Table 2.3–1** for the list of transfer syntaxes available for the Transfer Syntax Group.

2.3.1.3.1.2.1 SOP Specific DICOM Conformance to Storage SOP Classes

The DICOM SERVER AE provides Level 1 (BASE) Conformance, and stores all mandatory (Type 1 and 2) data elements of received SOP Instances. It also stores selected optional (Type 3) data elements, and private data elements for which it has a data dictionary entry, as described in Section 2.1 Introduction.

The DICOM SERVER AE does not support Digital Signatures Level 0 support, as it does not provide Level 2 (FULL) Conformance.

When a compressed image arrives on the station it is always stored in decompressed format. The Lossy Image Compression attribute (0028,2110) is added and set to “01” on originally lossy compressed images.

Successfully received SOP Instances may be accessed via the user interface and by DICOM network query retrieve. SOP Instances may be deleted by End Of Review or autodelete tools if configured so or manually by the user.

The DICOM SERVER does not perform coercion and data editing.

In case of failure, the image will not be installed in the local database. Following are the status codes the Application may send back to the SCU Equipment after performing the requested **Storage** :

Service Status	Status Code	Further Meaning	Status Code Explanation	Related Fields Sent Back to the SCU
Failure	A700	Refused: Out of resources	Indicates that probably there was not enough disk space to store the image or database inconsistency issue. The user should attempt recovery by removing some images from the Advantage Workstation 4.7. The association is aborted.	

	0110	Processing failure	Indicates that there was an internal error processing the incoming DICOM entity i.e. reading patient/exam/series/image level information from the message, converting messages to a file, writing the file to disk. The association is aborted.	
Success	0000		<p>Image is most probably declared in the database:</p> <p>In the event of a successful C-STORE operation, the image has successfully been written to disk, but may not have been declared in the database.</p> <p>For performance reasons the declaration of second and successor images of the same CT and MR series are not synchronized – while the declaration of the first image of each series is always done before status is sent back to SCU.</p> <p>Indeed, the successful status code is returned before the declaration of these images since it is assumed that if the first image was declared successfully and this image is written on the disk it has no reason not to be declared. Thus, if the declaration failed the association is aborted.</p>	None

Each C-STORE SCP operation supports an “Operation Inactivity Timer” with time out values of 605 seconds.

The image will then be accessed in the same manner as any other image by the applications on the Advantage Workstation 4.7.

When declaration of an image during a C-STORE operation fails, a message will appear in the browser informing the user of a failure.

Image Declaration phase:

Note:

To be displayed in the Viewer an image containing overlay planes defined in the high bits of the pixels (7FE0,0010) must fulfill the following conditions:

- the pixels are unsigned integers (0028,0103),
- the pixel allocated bits is equal to 16 (0028,0100)
- the overlay sizes, (60xx,0010) and (60xx,0011), are equal to the image size, (0028,0010) and (0028,0011)
- the overlay origins (60xx,0050) are equal to x=1, y=1,

Note:

To be displayed in the Viewer an image containing overlay planes defined in the header fields (60xx, 3000) must fulfill the following conditions:

- the file contains a single frame (0028,0008),
- the overlay origins (60xx,0050) are equal to x=1, y=1,

- the sizes of all overlays, (60xx,0010) and (60xx,0011), are equal to the image size, (0028,0010) and (0028,0011)

Note: Only the 8 first overlay planes can be displayed in the Viewer.

Note: The Viewer does not support multi-frame overlays ((60xx, 0015) and (60xx, 0051))

Note: Images that have the fields Patient's Name (0010,0010) and Patient ID (0010,0020) empty are accepted into the local database.

Note: If the pixel size is available measurement algorithm uses:

- either because defined in the image header
 - (0008,2111) for combined images
 - (0018,1164) or (0028,0030) if the first one is undefined, for CR images
 - (0018,1164) for Senovision, DX and MG images
 - (0028,0030) for other images
 - (no header field is used for XA and RF images)
- either because the end user has calibrated the image, measurements shall be indicated in millimeters for distance or square millimeters for areas. Otherwise, they shall be indicated in pixels or square pixels.

Note: Standalone Overlay Storage SOP Class instances will be formatted into Secondary Capture SOP Class instances when installed on the Advantage Workstation 4.7.

Note: All kind of color images are stored by the Advantage Workstation 4.7, but only images that have a photometric interpretation (0028,0004) equal to "MONOCHROME 1", "MONOCHROME 2", "PALETTE COLOR" or "RGB" with planar configuration (0028,0006) equal to 0 (color by pixel) or 1 (color by plane) are displayable.

Note: Modality LUT (0028,3000) will be ignored by the Advantage Workstation 4.7.

Note: Images with non-square pixels are not handled correctly by the Advantage Workstation 4.7.

Note: No optional data elements (Type 3) or filled data elements (Type 2) are required to be declared on the Advantage Workstation 4.7.

Note: When 2 images have the same DICOM Instance UID, the latest image received will overwrite the first received image if it has the same patient/study/series identifiers. It will be refused otherwise.

Note: AW annotates the contrast agent “+C” on the CT and MR images with the following algorithm:

If the manufacturer is “GE Medical Systems” then if the Contrast Agent (0018,0010) is valued and has a value different from “NONE” and if the Contrast Route (0018,0040) is valued and contains “IV” then “+C”

Otherwise if the manufacturer is not “GE Medical Systems” then, if the Contrast Agent (0018,0010) is valued and has a value different from “NONE” then “+C”.

2.3.1.3.1.3 Presentation Context Acceptance Criterion

The DICOM SERVER AE evaluates each Presentation Context independently, and accepts any Presentation Context that matches an Abstract Syntax for any Real-World Activity.

2.3.1.3.1.4 Transfer Syntax Selection Policies

Within each Presentation Context, the DICOM SERVER AE will select Transfer Syntaxes according to the following priority (highest priority first):

If the compressed DICOM networking is enabled:

1. JPEG Lossless HIER 14
2. JPEG 2000 Lossless ONLY
3. JPEG Baseline (Process 1)
4. JPEG Extended (Process 2 & 4)
5. JPEG 2000
6. Explicit VR Little Endian
7. Explicit VR Big Endian
8. Implicit VR Little Endian

If the compressed DICOM networking is disabled:

1. Explicit VR Little Endian
2. Explicit VR Big Endian
3. Implicit VR Little Endian

2.3.1.3.2 Real-World Activity: Query Request from Remote AE

This AE is indefinitely listening for associations. No operator action is required to respond to a *query* request.

2.3.1.3.2.1 Associated Real-World Activity

The Real-World Activity associated with the query request is to search the local database for entries that match the request and send a C-FIND response message with a status of "pending" for each matching entry and send a C-FIND response message with a status of "success" after the last "pending" response.

If the C-FIND SCP receives a C-FIND-CANCEL request, it sends a C-FIND response message with a status of "cancel".

2.3.1.3.2.2 Association Acceptance Policy

The DICOM SERVER AE refuses the association if they are too many opened connections.

2.3.1.3.2.3 Presentation Context Table

Acceptable Presentation Contexts for DICOM Server AE and Real-World Activity Query Request.

Presentation Context Table by DICOM SERVER AE for Activity Query Request					
Abstract Syntax		Transfer Syntax Group		Role	Extended Negotiation
Name	UID	Name			
Study Root Query/Retrieve Information Model - FIND	1.2.840.10008.5.1.4.1.2.2.1	Uncompressed Transfer Group		SCP	None

Note: See **Table 2.3–1** for the list of transfer syntaxes available for the Transfer Syntax Group.

2.3.1.3.2.3.1 SOP Specific Conformance to C-FIND SCP

The DICOM SERVER AE provides matching against query keys as described in 14 - QUERY Implementation.

Following are the status codes the Application may send back to the SCU Equipment while performing the requested **Query** :

Service Status	Status Code	Further Meaning	Status Code Explanation	Related Fields Sent Back to the SCU
Failure	A700	Refused: Out of resources	When too many connections are open at the same time.	None
	A900	Error: Identifier does not match SOP Class	When the DICOM Server AE processes an invalid data set.	None
	C001	Error: Unable to process	When the DICOM Server AE processes an internal error or a decoding error	None
Cancel	FE00	Matching terminated due to cancel	If the DICOM remote AE sent a DICOM C-FIND CANCEL request	None

Success	0000	Matching is complete - No final identifier is supplied		None
Pending	FF00	Matches are continuing - Current Match is supplied and any Optional Keys were supported in the same manner as Required Keys.	For pending messages	None
	FF01	Matches are continuing - Warning that one or more Optional Keys were not supported for existence and/or matching for this Identifier	For pending messages when the DICOM remote AE asked for optional key	None

Each C-FIND SCP operation supports an “Operation Inactivity Timer” with a time out value of 605 seconds. This timer corresponds to the number of seconds to wait when data between TCP/IP packets are transferred.

2.3.1.3.2.4 Presentation Context Acceptance Criteria

See 2.3.1.3.1.3 - Presentation Context Acceptance Criterion.

2.3.1.3.2.5 Transfer Syntax Selection Policy

Only uncompressed transfer syntaxes are selected from the section 2.3.1.3.1.4 - Transfer Syntax Selection Policies.

2.3.1.3.3 Real-World Activity: Retrieve Request From Remote AE

This AE is indefinitely listening for associations. No operator action is required to respond to a *retrieve* request.

2.3.1.3.3.1 Associated Real-World Activity

The Real-World Activity associated with the Retrieve Request is to send all images corresponding to the C-MOVE request to the destination AE through a separate association.

If the C-MOVE SCP receives a C-MOVE-CANCEL request, it closes the separate association.

2.3.1.3.3.2 Association Acceptance Policy

The DICOM SERVER AE rejects the association if they are too many open connections.

The DICOM SERVER AE rejects the association if the Remote DICOM AE is not declared on the local Advantage Workstation 4.7.

2.3.1.3.3.3 Presentation Context Table

Acceptable Presentation Contexts for DICOM Server AE and Real-World Activity Retrieve Request.

Presentation Context Table by DICOM SERVER AE for Activity Retrieve Request From Remote AE				
Abstract Syntax		Transfer Syntax Group	Role	Extended Negotiation
Name	UID	Name		
Study Root Query/Retrieve Information Model - MOVE	1.2.840.10008.5.1.4.1.2.2.2	Uncompressed Transfer Group	SCP	None
Patient Root Query/Retrieve Information Model - MOVE	1.2.840.10008.5.1.4.1.2.1.2	Uncompressed Transfer Group	SCP	None

Note: See **Table 2.3–1** for the list of transfer syntaxes available for the Transfer Syntax Group.

2.3.1.3.3.3.1 SOP Specific Conformance to C-MOVE SCP

The DICOM SERVER AE supports Storage Sub-operations for Instances of any of the Composite SOP Classes it supports as an SCU (see Section 2.3.1.2.1 Real-World Activity: Push Studies/Series/Images to Remote AE).

The DICOM Server AE provides standard conformance to the baseline Study-root C-MOVE Service Class SCP and Patient-root C-MOVE Service Class SCP.

The DICOM Server AE supports C-MOVE Service Class SCP to any known DICOM Remote host referenced by MOVE AE.

Following are the status codes the Application may send back to the SCU Equipment while performing the requested **Retrieve** :

Service Status	Status Code	Further Meaning	Status Code Explanation	Related Fields Sent Back to the SCU
Failure	A701	Refused: Out of resources - Unable to calculate number of matches	When there is too much data to process.	None
	A702	Refused: Out of resources - Unable to perform sub-operations	When the association with the C-STORE SCP was rejected.	None
	A801	Error: Move Destination Unknown	When the destination unknown.	None
	A900	Error: Identifier does not match SOP Class	When the dataset is invalid.	None
Cancel	FE00	Sub-operations terminated due to a Cancel indication	(C-Move Cancel Request Received) when the C-MOVE SCU cancelled the operation	None
Warning	B000	Sub-operations Complete - One or more Failures.	When one or more failure occurred.	None
Success	0000	Sub-operations Complete - No Failure.	When the whole C-MOVE operation was successful	None

Pending	FF00	Sub-operations are continuing -	For pending messages.	(0000,1020) (0000,1021) (0000,1022) (0000,1023)
---------	------	---------------------------------	-----------------------	--

Each C-MOVE SCP operation supports an “Operation Inactivity Timer” with a time out value of 605 seconds. This timer corresponds to the number of seconds to wait when data between TCP/IP packets are transferred.

All images requested in a C-MOVE-RQ will be sent over a single association. A C-MOVE-RSP with a “pending” status will be returned to the requester every seven seconds.

2.3.1.3.3.4 Presentation Context Acceptance Criteria

See 2.3.1.3.1.3 - Presentation Context Acceptance Criterion.

2.3.1.3.3.5 Transfer Syntax Selection Policy

Only uncompressed transfer syntaxes are selected from the section 2.3.1.3.1.4 - Transfer Syntax Selection Policies.

2.3.1.3.4 Real-World Activity: DICOM Ping from remote DICOM host

2.3.1.3.4.1 Associated Real-World Activity

The Real-World Activity associated with the DICOM Ping from remote host operation is to check the status of the DICOM Server AE.

2.3.1.3.4.2 Association Acceptance Policy

The DICOM SERVER AE rejects the association if they are too many open connections.

2.3.1.3.4.3 Presentation Context Table

Acceptable Presentation Contexts for DICOM Server AE and Real-World Activity DICOM Ping from remote DICOM host.

Presentation Context Table by DICOM SERVER AE for Activity DICOM Ping from remote host				
Abstract Syntax		Transfer Syntax Group	Role	Extended Negotiation
Name	UID	Name		
Verification	1.2.840.10008.1.1	Uncompressed Transfer Group	SCP	None

Note: See **Table 2.3–1** for the list of transfer syntaxes available for the Transfer Syntax Group.

2.3.1.3.4.4 Presentation Context Acceptance Criteria

See 2.3.1.3.1.3 - Presentation Context Acceptance Criterion.

2.3.1.3.4.5 Transfer Syntax Selection Policy

Only uncompressed transfer syntaxes are selected from the section 2.3.1.3.1.4 - Transfer Syntax Selection Policies.

2.3.2 DICOM STORAGE COMMITMENT SERVER AE Specification

This Application Entity provides Standard Conformance to the following DICOM SOP Classes as an SCU:

SOP Class Name	SOP Class UID
Storage Commitment Push Model	1.2.840.10008.1.20.1

2.3.2.1 Association Establishment Policies

2.3.2.1.1 General

The DICOM STORAGE COMMITMENT SERVER AE uses the same resources as the DICOM SERVER AE, for detailed information please read the section 2.3.1.1 Association Establishment Policies of DICOM SERVER AE.

2.3.2.1.2 Number of Associations

The DICOM STORAGE COMMITMENT SERVER AE will initiate only one DICOM association at a time to perform a DICOM storage commitment operation as a SCU to a Remote DICOM AE.

The DICOM STORAGE COMMITMENT SERVER AE can have a maximum of 2 open DICOM associations at a time to perform a DICOM storage commitment operation as a SCU with Role/selection negotiation.

The Storage Commitment Provider AE can be configured independently from the remote DICOM AE with network address, port and AE title.

Storage Commitment request is sent just after images has been remotely stored.

2.3.2.1.3 Asynchronous Nature

Asynchronous mode is not supported. All operations will be performed synchronously.

2.3.2.1.4 Implementation Identifying Information

The DICOM STORAGE COMMITMENT SERVER AE uses the same resources as the DICOM SERVER AE, for detailed information please read the section 2.3.1.1 Association Establishment Policies of DICOM SERVER AE.

2.3.2.2 Association Initiation Policy

When the DICOM STORAGE COMMITMENT SERVER AE Application Entity initiates an Association for any Real-World Activity, it will propose the Presentation Contexts for all Real-World Activities; i.e., there is only a single, comprehensive Presentation Context Negotiation proposed for the AE.

The DICOM STORAGE COMMITMENT SERVER AE proposes only a single Transfer Syntax in each Presentation Context; i.e., for each Abstract Syntax in the following

Presentation Context Tables, the AE proposes one Presentation Context for each specified Transfer Syntax.

2.3.2.2.1 Real-World Activity: Initiate Storage Commitment to a Remote AE

2.3.2.2.1.1 Associated Real-World Activity

The operator can associate a DICOM Storage Commitment Provider AE option to a Remote AE in the Network Manager. When the user selects a Remote AE with this option enabled STORAGE COMMITMENT AE will always try to initiate a Storage Commitment.

The user selects in the BROWSER one or several studies, series or images to be sent. Then, the user can either drag and drop the selection on the icon representing then Remote DICOM AE, or click on the “Push” icon and select a Remote DICOM AE in the LIST OF REMOTE HOST. The user can also decide to use the ‘end review’ paradigm to send a set of series of the same patient.

This operation will cause the following actions:

- The Advantage Workstation 4.7. retrieves the appropriate DICOM images to push from its database.
- The DICOM SERVER AE initiates a DICOM association, negotiates with the Remote AE an appropriate Abstract and Transfer Syntax.
- If the negotiation is successful, the DICOM SERVER AE emits C-STORE command to send the images to the Remote AE.
- When the images have been sent, the DICOM SERVER AE asks the DICOM STORAGE COMMITMENT SERVER AE to commit all the images that have been successfully sent.
- The DICOM STORAGE COMMITMENT SERVER AE initiates a DICOM association, negotiates with the Remote AE an appropriate Abstract and Transfer Syntax.
- If the negotiation is successful, the DICOM STORAGE COMMITMENT SERVER AE emits a N-ACTION request. Only one N-ACTION request is sent for all images to be committed.
- If the DICOM STORAGE COMMITMENT SERVER AE receives a successful N-ACTION RSP, the server waits a configurable period of time (default = 10s) for the reception of a N_EVENT_REPORT. (See section *Real-World Activity “Listen to remote Storage Commitment SCP”*)

2.3.2.2.1.2 Association Initiation Policy

Only one N-ACTION request is sent for all images that have been sent during the Real World Activity: “Push Studies/Series/images to Remote AE”

2.3.2.2.1.3 Proposed Presentation Context

Presentation Context Table - Proposed
--

Abstract Syntax		Transfer Syntax Group	Role	Extended Negotiation
Name	UID	Name		
Storage Commitment Push Model	1.2.840.10008.1.20.1	Uncompressed Transfer Group	SCU	None

Note: See **Table 2.3–1** for the list of transfer syntaxes available for the Transfer Syntax Group.

2.3.2.2.1.3.1 SOP Specific DICOM Conformance Statement for the Storage Commitment Push Model SOP Class SCU (N-ACTION)

The DICOM STORAGE COMMITMENT SERVER AE can receive a N-EVENT-REPORT from the Storage Commitment Provider at any time (See section *Real-World Activity “Listen to remote Storage Commitment SCP”*).

The DICOM STORAGE COMMITMENT SERVER AE uses DICOM network storage services to transfer SOP Instance List which are to be committed. It does not support the optional Storage Media File-Set ID and UID Attributes in the Storage Commitment N-ACTION for transfer of SOP Instances by media for Storage Commitment.

The DICOM STORAGE COMMITMENT SERVER AE may request Storage Commitment for Instances of any of the Composite SOP Classes it supports as an SCU (see Section 2.3.1.2.1 for Real-World Activity: Push Studies/Series/Images to Remote AE).

The Storage Commitment Information Object is described in Section 4.

If the received N-ACTION Response from the Storage Commitment Provider has a success status, the DICOM STORAGE COMMITMENT SERVER AE waits for an N-EVENT-REPORT during a configurable period of time. This period is set to 10s by default.

Following are the status codes that are more specifically processed when receiving N-Action responses from a **Storage Commitment SCP** equipment:

Service Status	Status Code	Further Meaning	Application Behavior When Receiving Status Code
Failure	0119	Class-instance conflict	An error file is logged, the Storage Commitment is abandoned and a pop-up is displayed to the user.
	0210	Duplicate invocation	
	0115	Invalid argument value	
	0117	Invalid SOP Instance	
	0212	Mistyped argument	
	0123	No such action	
	0114	No such argument	

	0118	No such SOP Class	
	0112	No such SOP Instance	
	0110	Processing failure	
	0213	Resource limitation	
	0211	Unrecognized operation	
Success	0000		For each image successfully committed, the image is flagged as “Committed” into the database.
*	*	Any other status code.	Ignored

2.3.2.2.2 Real-World Activity: Open periodic association

2.3.2.2.2.1 Associated Real-World Activity

The operator can associate a DICOM Storage Commitment Provider AE to a Remote AE.

The system periodically scans the configuration file and opens an “empty” association with all the Remote DICOM AE declared as Storage Commitment Provider. The association is always opened even if Advantage Workstation does not expect any N_EVENT_REPORT. The time between two association creation is configurable by GE Field Engineer – even to large numbers, that is it can be practically turned off.

This periodic association enables a Storage Commitment Provider to send an N_EVENT_REPORT during a standard association negotiation.

This operation will cause the following actions:

- The DICOM STORAGE COMMITMENT SERVER AE initiates a DICOM association, negotiates with the Remote AE an appropriate Abstract and Transfer Syntax.
- If the negotiation is successful, the DICOM STORAGE COMMITMENT SERVER AE waits a configurable period of time (default = 10s) for the reception of a N_EVENT_REPORT. (See section *Real-World Activity “Listen to remote Storage Commitment SCP”*)

2.3.2.2.2.2 Association Initiation Policy

After the association negotiation, the DICOM STORAGE COMMITMENT SERVER AE waits for an incoming N_EVENT_REPORT.

2.3.2.2.2.3 Proposed Presentation Context

See the general Proposed Presentation Context DICOM STORAGE COMMITMENT SERVER AE in Section 2.3.2.2.1.3.

**2.3.2.2.2.3.1 SOP Specific DICOM Conformance Statement for the Storage Commitment Push Model SOP Class (N-
_EVENT_REPORT)**

The DICOM STORAGE COMMITMENT SERVER AE waits for an N-EVENT-REPORT during a configurable period of time. This period is set to 10s by default.

The DICOM STORAGE COMMITMENT SERVER AE can receive a N-EVENT-REPORT from the Storage Commitment Provider at any time (See section *Real-World Activity “Listen to remote Storage Commitment SCP”*).

Following are the status codes the DICOM STORAGE COMMITMENT SERVER AE may send back in the **N-Event-Report** response command to the **Storage Commitment SCP** Equipment that sent the N-Event-Report request:

Service Status	Status Code	Further Meaning	Status Code Explanation	Related Fields Sent Back to the SCU
Failure	0110	Processing failure	This status code is sent back on any error during database manipulations or internal communication failures.	(0000,0002) (0000,0120) (0000,1000) (0000,1002)
Success	0000		Report could be processed without any issue.	None

2.3.2.3 Association Acceptance Policy

2.3.2.3.1 Real-World Activity: Listen to remote Storage Commitment SCP

The DICOM STORAGE COMMITMENT SERVER AE is indefinitely listening for associations. No operator action is required to receive a Storage Commitment notification (N-EVENT-REPORT).

2.3.2.3.1.1 Associated Real-World Activity

The Real-World Activity associated consists into:

- Flag the images that have been committed (transfer of ownership) in the database.
- Pop up an error when some images of a patient existing in the database have not been committed.

2.3.2.3.1.2 Association Acceptance Policy

The Storage Commitment Provider initiating the association must use the role selection negotiation.

2.3.2.3.1.3 Proposed Presentation Context

See the general Proposed Presentation Context DICOM STORAGE COMMITMENT SERVER AE in Section 2.3.2.2.1.3.

2.3.2.3.1.3.1 SOP Specific DICOM Conformance Statement for the Storage Commitment Push Model SOP Class (N-EVENT-REPORT)

The DICOM STORAGE COMMITMENT SERVER AE will propose the SCP role (via SCP/SCU Role Selection Negotiation) within a Presentation Context for the Storage Commitment Push Model SOP Class. If the destination does not accept that Role Negotiation, the AE will not be able to send Storage Commitment Results using N-Event-Report Requests.

Following are the status codes the Application may send back to the SCP Equipment after receiving the N-EVENT-REPORT:

Service Status	Status Codes	Further Meaning	Status Code sending explanation	Related Fields sent back to the SCU
Error	0110	Processing Failure	Indicates that an internal error occurs while processing.	None
Success	0000			None

The DICOM STORAGE COMMITMENT SERVER AE parses all the items present in the N-EVENT-REPORT.

For each image successfully committed, the image is flagged as “Committed” into the database. An error is logged for any image that cannot be committed and a pop up is displayed to the user when the image still exists in the database.

2.3.2.3.2 Real-World Activity: DICOM Ping from remote DICOM host

2.3.2.3.2.1 Associated Real-World Activity

The Real-World Activity associated with the DICOM Ping from remote host operation is to check the status of the DICOM STORAGE COMMITMENT SERVER AE.

2.3.2.3.2.2 Association Acceptance Policy

The DICOM STORAGE COMMITMENT SERVER AE rejects the association if they are too many open connections.

2.3.2.3.2.3 Presentation Context Table

Acceptable Presentation Contexts for DICOM STORAGE COMMITMENT SERVER AE and Real-World Activity DICOM Ping from remote DICOM host.

Presentation Context Table by DICOM STORAGE COMMITMENT SERVER AE for Activity DICOM Ping from remote host			
Abstract Syntax	Transfer Syntax Group	Role	Extended

Name	UID	Name		Negotiation
Verification	1.2.840.10008.1.1	Uncompressed Transfer Group	SCP	None

Note: See **Table 2.3–1** for the list of transfer syntaxes available for the Transfer Syntax Group.

2.3.2.3.2.4 Presentation Context Acceptance Criteria

See 2.3.1.3.1.3 - Presentation Context Acceptance Criterion.

2.3.2.3.2.5 Transfer Syntax Selection Policy

Only uncompressed transfer syntaxes are selected from the section 2.3.1.3.1.4 - Transfer Syntax Selection Policies.

2.3.3 DICOM Print SCU AE Specification

This Application Entity provides Standard Conformance to the following DICOM SOP Classes as an SCU:

SOP Class Name	SOP Class UID
Basic Grayscale Print Management Meta SOP Class	1.2.840.10008.5.1.1.9
Basic Color Print Management Meta SOP Class	1.2.840.10008.5.1.1.18

Note: Support of the Basic Grayscale Print Management Meta SOP Class as an SCU mandates support for the Basic Film Session, Basic Film Box, Basic Grayscale Image Box and Printer SOP Classes as an SCU.

Note: Support of the Basic Color Print Management Meta SOP Class as an SCU mandates support for the Basic Film Session, Basic Film Box, Basic Color Image Box and Printer SOP Classes as an SCU.

2.3.3.1 Association Establishment Policies

2.3.3.1.1 General

The DICOM Application Context Name (ACN) that is always proposed is:

Application Context Name	1.2.840.10008.3.1.1.1
---------------------------------	------------------------------

The Maximum Length PDU negotiation is included in all association establishment requests.

The maximum length PDU for an association initiated by the DICOM Print SCU is:

Maximum Length PDU	28672 Bytes
---------------------------	--------------------

The Print Management Service Class does not support extended negotiation.

The user information Items sent by this product are:

- Maximum PDU Length
- Implementation UID

Note: The Maximum length PDU is not configurable

2.3.3.1.2 Number of Associations

The DICOM Print SCU AE supports only one association at a time. The printing requests are internally queued.

2.3.3.1.3 Asynchronous Nature

Asynchronous mode is not supported. All operations will be performed synchronously.

2.3.3.1.4 Implementation Identifying Information

The Implementation UID for this DICOM Implementation is:

Advantage Workstation 4.7 Filmer Implementation UID	1.2.840.113619.6.377
--	-----------------------------

2.3.3.2 Association Initiation Policy

2.3.3.2.1 Real-World Activity “Manual Image Print”

2.3.3.2.1.1 Associated Real-World Activity

The user has the possibility to drag and drop images from the VIEWER to the FILMER application. The Print Manager application allows to define, suppress and select different REMOTE DICOM printers and to manipulate some print parameters like the number of copies. When the user requests for a print by pushing the “Print” button, the DICOM Print SCU tries to establish the association with the requested printer and sends the images for printing.

Note: The Print Builder application allows to select different REMOTE DICOM printers and to manipulate some print parameters like the number of copies.

GE Healthcare

DIR 5479848-1EN REV 1

2.3.3.2.1.2 Proposed Presentation Context Table

Presentation Context Table – Proposed					
Abstract Syntax		Transfer Syntax		Role	Extended Negotiation
Name	UID	Name List	UID List		
Basic Grayscale Print Management Meta SOP Class	1.2.840.10008.5.1.1.9	Implicit VR Little Endian	1.2.840.10008.1.2	SCU	None
Basic Color Print Management Meta SOP Class	1.2.840.10008.5.1.1.18	Implicit VR Little Endian	1.2.840.10008.1.2	SCU	None

2.3.3.2.1.2.1 SOP Specific DICOM Conformance Statement for Print Management SOP Classes

The DICOM Print SCU AE initiates one association with the selected REMOTE DICOM Printer. The DICOM Print SCU AE will not open another association while the current one is active.

The Basic Grayscale Print Management Meta SOP Class and the Color Grayscale Print Management Meta SOP Class are never negotiated simultaneously.

For each of the supported Print Management SOP and Meta SOP Classes, the optional attributes and service elements supported, the valid range of values for mandatory and optional attributes, and the status code behavior are described in Section 6.

2.3.3.2.2 Real-World Activity “Direct Image Print”

2.3.3.2.2.1 Associated Real-World Activity

The user has the possibility to directly send images from the VIEWER to the Print Builder application. The Print Builder application will launch the DICOM Print SCU that tries to establish the association with the default printer and sends the images for printing.

2.3.3.2.2.2 Proposed Presentation Context Table

Presentation Context Table – Proposed					
Abstract Syntax		Transfer Syntax		Role	Extended Negotiation
Name	UID	Name List	UID List		
Basic Grayscale Print Management Meta SOP Class	1.2.840.10008.5.1.1.9	Implicit VR Little Endian	1.2.840.10008.1.2	SCU	None
Basic Color Print Management Meta SOP Class	1.2.840.10008.5.1.1.18	Implicit VR Little Endian	1.2.840.10008.1.2	SCU	None

2.3.3.2.2.1 SOP Specific DICOM Conformance Statement for Print Management SOP Classes

The DICOM Print SCU AE initiates one association with the selected REMOTE DICOM Printer. The DICOM Print SCU AE will not open another association while the current one is active.

The Basic Grayscale Print Management Meta SOP Class and the Color Grayscale Print Management Meta SOP Class are never negotiated simultaneously.

For each of the supported Print Management SOP and Meta SOP Classes, the optional attributes and service elements supported, the valid range of values for mandatory and optional attributes, and the status code behavior are described in Annex.

2.4 COMMUNICATION PROFILES

2.4.1 Supported Communication Stacks

The DICOM Upper Layer Protocol is supported using TCP/IP, as specified in DICOM PS3.8.

The TCP/IP stack is inherited from a Unix Operating System.

2.4.2 Physical Media Support

The product is provided with a 10/100/1000 Mb/s auto-sensing Ethernet interface. Additional or alternate network interfaces may be available.

Note: For more information about the Physical Media available on Advantage Workstation 4.7, please refer to the Product Data Sheet.

2.5 EXTENSIONS / SPECIALIZATIONS/ PRIVATIZATIONS

2.5.1 Standard Extended / Specialized / Private SOP Classes

Some Private SOP Classes can be used by this product but are not exported outside of the station and so are not described below.

2.5.1.1 Standard Extended SOP Classes

The product provides Standard Extended Conformance to all supported SOP Classes, through the inclusion of additional Type 3 Standard Elements and Private Data Elements.

2.5.1.1.1 Extended Enhanced SR object

The extension of this SOP Class is described in paragraph 8 - ENHANCED SR INFORMATION OBJECT IMPLEMENTATION.

The Enhanced DICOM SR does not implement the TID 2000 but the private ELECTRONIC FILM TID. Refer to §8.

GE Healthcare

DIR 5479848-1EN REV 1

2.5.1.1.2 Extended Secondary Capture object

The extension of this SOP Class is described in paragraph 7 - SC INFORMATION OBJECT IMPLEMENTATION.

2.5.1.2 Private SOP Class GE DICOM Private 3D object

GE Private 3D Model Objects are described in the AW VXTL DCS, see 1.6 - References

2.5.1.3 Private SOP Class GE DICOM Private NM image

GE Private DICOM NM image Objects are described in the GENIE DCS, see 1.6 - References.

2.5.1.4 Private SOP Class GE DICOM Private PET image

GE Private DICOM PET image Objects are described in the ADV DCS, see 1.6 - References.

2.5.2 Private Transfer Syntaxes

No Private Transfer Syntax is supported.

2.6 CONFIGURATION

2.6.1 AE Title/Presentation Address Mapping

The GE Field Engineer must configure the hostname of the station during installation. The hostname will then be used for the AET address mapping.

DICOM SERVER AE

The Local AE Title is set to hostname.

DICOM STORAGE COMMITMENT SERVER AE

The Local AE Title is set to SCU_hostname.

The GE Field Engineer can update the DICOM STORAGE COMMITMENT SERVER AET in a configuration file

DICOM PRINT SCU AE

The local DICOM Print SCU AE Title is: "PR_Hostname" where Hostname is the system hostname defined at installation. The default AET PR_Hostname can be overwritten by GE Field Engineer if the length of Local DICOM Print SCU AE Title exceeds 16 characters.

2.6.2 Configurable Parameters

The following fields are configurable for the DICOM SERVER AE (local):

- Local AE Title

- Local IP Address (defined by the station)
- Local IP Netmask (defined by the station)

The Local Listening Port Number is not configurable and set to **4006**.

The following fields are configurable for the DICOM STORAGE COMMITMENT SERVER AE (local):

- Local AE Title
- Local IP Address (defined by the station)
- Local IP Netmask (defined by the station)

The Local Listening Port Number is configurable and set to **4008**.

The following fields are configurable for every remote DICOM AE and DICOM STORAGE COMMITMENT AE:

- Remote AE Title
- Remote IP Address
- Listening TCP/IP Port Number

A **default router** IP Address for **all remote nodes** can be configured as well as some specific routes.

The following fields are configurable:

- Association Establishment Timer
- Store, Find, Move, Timers
- Inactivity Timers
- Maximum Length PDU

The following fields are configurable for the DICOM PRINT SCU AE (local):

~sdc/AIA/bin/configure.printAET

- Local AE Title

Note: The Local IP address and the local IP netmask are the ones of the workstation

Note: No local Port Number is defined because the product is never responding to an association request.

The following fields are configurable for every remote DICOM AE:

- Remote AE Title
- Remote IP Address
- Listening TCP/IP Port Number

The Service Tools allow the administrator to add, delete, or update the Remote DICOM Printers parameters described above.

A default router IP Address for all DICOM remote nodes (including printers, Storage SCP Workstations...) can be configured as well as some specific routes.

The following fields are configurable:

- Message report timeout (default=60s)
- Event report timeout (default=3600s)
- Maximum PDU Length

The GE Field Engineer can update this configuration.

Only one association can be performed at a time by this implementation.

Note: All configurations must be performed by a GE Field Engineer.

Note: Configuration Information (2010,0150) is set by the User during the DICOM printer declaration.

2.7 SUPPORT OF EXTENDED CHARACTER SETS

The AW4.7 will support the following character sets:

- without character set indication ISO IR 6 as default,
- ISO IR 100 (Latin1),
- ISO IR144 (Russian),
- ISO IR 192 (UTF-8),
- GB18030 (Chinese),
- ISO IR 149 (Korean),
- ISO IR 13, ISO IR 87 (Japanese).

as extended character sets.

These extended charactersets are supported in DICOM data exchange and in the database (as currently described in the DICOM 2015b standard).

For specific applications and possible restrictions please find the details in the Dicom Conformance Statement for the specific application.

For other extended character sets, they will be supported for DICOM data exchange and in the database (as currently described in the DICOM 2015b standard). But applications, which will load and manipulate these data, may have a restrictive behavior.

2.8 CODES AND CONTROLLED TERMINOLOGY

The product uses no coded terminology.

2.9 SECURITY PROFILES

The product does not conform to any defined DICOM Security Profiles.

It is assumed that the product is used within a secured environment. It is assumed that a secured environment includes at a minimum:

1. Firewall or router protections to ensure that only approved external hosts have network access to the product.
2. Firewall or router protections to ensure that the product only has network access to approved external hosts and services.
3. Any communications with external hosts and services outside the locally secured environment use appropriate secure network channels (such as a Virtual Private Network (VPN))

3. MEDIA STORAGE CONFORMANCE STATEMENT

3.1 INTRODUCTION

This section of the DICOM conformance statement specifies the Advantage Workstation 4.7 compliance to DICOM requirements for Media Interchange. It details the DICOM Media Storage Application Profiles and roles that are supported by this product.

This station provides capabilities to DICOM interchange on CD-Rs (Compact Disc-Recordable), DVDs (Digital Versatile Disc) and USB (Universal Serial Bus) with different application profiles supported. The Advantage Workstation 4.7 Core Software provides the DICOM interchange capability for all the applications that may be used on the Advantage Workstation 4.7 basis. Please, refer to the DICOM conformance statement of each added application for a complete description of their compliance to DICOM.

Note: Due to technology issues, it is possible that some types of DVDs cannot be read or burnt on the Advantage Workstation 4.7. The function of reading and generating DICOM interchange DVDs is also dependent of the hardware on which the Advantage Workstation 4.7 release is installed.

3.2 IMPLEMENTATION MODEL

3.2.1 Application Data Flow Diagram

The CD/DVD/USB DICOM Media Server Application Entity (AE) handles the DICOM CREATE CD/RESTORE CD functionality for the CD-R, CD-RW, CD+R, CD+RW device as well as the DICOM CREATE DVD/RESTORE DVD functionality for the DVD+/-RW device and the DICOM CREATE USB/RESTORE USB functionality for the USB device. The CD/DVD/USB DICOM Media Server Application Entity (AE) is commanded by the user to perform DICOM services operating on the DICOM media through the use of buttons and menu selections on the graphical user interface of the station.

The user selects the type of media (either CD, DVD or USB) and then requests the creation of a DICOM File Set and the writing of this DICOM File Set on blank media by selecting images in the local Browser and inserting them in the Media Composer. Then, the images of the different media to burn will be generated. Once the generation has been done, the user can ask to burn the complete set of data on one or more media of the same type (CD, DVD or USB)

The user can request the reading of a DICOM file set written on an interchange media by selecting the CD/DVD/USB drive as the active device, and browsing the media using the “Query” Item of the device drop down menu, and then restore the selected items by a drag and drop on the local browser icon or by clicking on the suitable restore buttons.

The media interchange application model for the Advantage Workstation 4.7 is shown in the following Illustration :

CD/DVD/USB DICOM Media Server AE Model

ILLUSTRATION 3-1
ADVANTAGE WORKSTATION 4.7 MEDIA INTERCHANGE APPLICATION MODEL AND DATA FLOW DIAGRAM

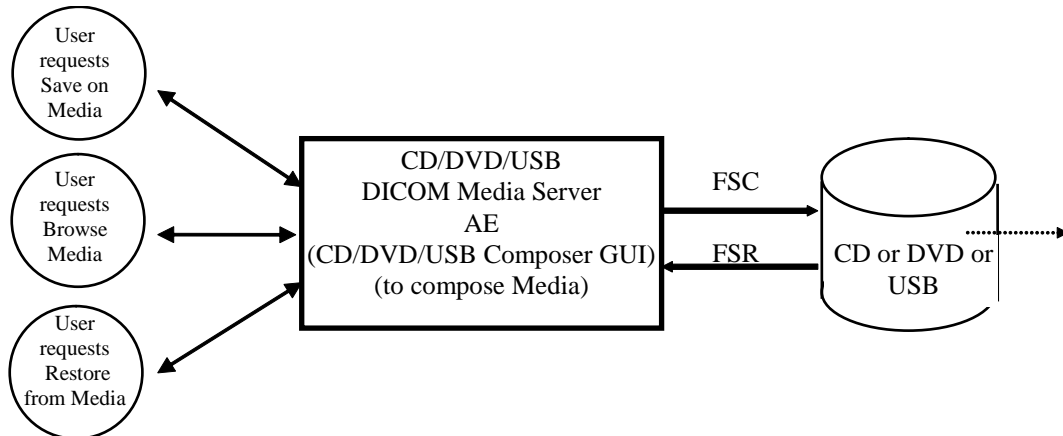

3.2.2 Functional Definition of the DICOM Media Server AE

3.2.2.1 Functional definition of the DICOM Media Server AE

The CD/DVD/USB DICOM Media Server Application Entity supports the following functions:

- Has access to patient demographics and pixel data in the local database.
- Can generate a DICOM File Set (FSC) in a one shot activity.
- Can update DICOM File Set on USB in a very limited way { see notes }.
- Can write a DICOM File Set (FSC) on a CD-R, CD+R, CD-RW, CD+RW, DVD+R, DVD+RW, DVD-R, DVD-RW
- Can read a DICOM File Set (FSR) on CD-R, CD+R, CD-RW, CD+RW, CDROM, DVD-R, DVD+R, DVD-RW, DVD+RW, DVDROM

Note: Due to technology issues, it is possible that some types of DVDs cannot be read or burnt on the Advantage Workstation 4.7. The function of reading and generating DICOM interchange DVDs is also dependent of the hardware on which the Advantage Workstation 4.7 release is installed.

Note: When exporting data to a USB mass storage device using the Media Composer, the data exported to the USB device will not be fully DICOM compliant if images or series from an exam originate from different Media Composer sessions. In such cases, they will appear on the USB device as duplicate entries on the patient level. When retrieving data from a USB device, the user always have to sort the images/series by the Patient Name / Patient ID and review the list to make sure that all exams belong to the same patient. If the Exam list on the USB media is sorted by any criteria other than Patient Name / Patient ID, you may miss additional entries for the selected patient.

GE Healthcare

DIR 5479848-1EN REV 1

3.2.3 Sequencing of Real-World Activities

Non Applicable.

3.2.4 File Meta Information Options (See PS3.10)

The File Meta-Information for this implementation is :

File Meta-Information Version	1
Advantage Workstation 4.7 Implementation UID	1.2.840.113619.6.350
Advantage Workstation 4.7 Implementation Version Name	The Implementation Version Name represents the canonical version of the AW, for example: AW4_7_01_186_HEL
Source Application Entity Title	The Source Application Entity Title is derived from the hostname

3.2.5 Sequencing Requirements

For writing on CD, DVD it is necessary to use blank media. The support of media depends of the hardware that is used.

For writing an USB it is not necessary to use blank media.

3.3 AE SPECIFICATIONS

3.3.1 DICOM MEDIA SERVER AE Specification

The DICOM CD/DVD/USB SERVER Application Entity provides standard conformance to DICOM Interchange Option of the Media Storage Service Class. The supported Application Profiles and roles are listed below.

Supported Application Profile	Real World Activity	Role	Description
STD-GEN-CD STD-XABC-CD AUG-XABC-CD	Browse Media (CD) Restore Media (CD)	FSR	Interchange
STD-GEN-CD STD-XABC-CD AUG-XABC-CD	Create Media (CD)	FSC	Interchange
STD-GEN-DVD-JPEG STD-GEN-DVD-J2K	Browse Media (DVD) Restore Media (DVD)	FSR	Interchange
STD-GEN-DVD-JPEG	Create Media (DVD)	FSC	Interchange

STD-GEN-USB-JPEG STD-GEN-USB-J2K	Browse Media (USB) Restore Media (USB)	FSR	Interchange
STD-GEN-USB-JPEG	Create Media (USB)	FSC	Interchange

Note: The supported compressed transfer syntaxes in STD-GEN-DVD-JPEG, STD-GEN-DVD-J2K, STD-GEN-USB-JPEG and STD-GEN-USB-J2K are defined in by Compressed Transfer Group in **Table 2.3–1**

3.3.1.1 File Meta Information for the DICOM MEDIA SERVER Application Entity

See the table in Section 3.2.4 - File Meta Information Options (See PS3.10).

3.3.1.2 Real-World Activities for the DICOM MEDIA SERVER Application Entity

3.3.1.2.1 Real-World Activity (RWA) “Browse Media”

The CD/DVD/USB DICOM Media Server AE acts as an FSR using the interchange option when requested to browse the media.

When the CD/DVD/USB DICOM Media Server AE is requested to provide a directory listing, it reads the File-set and displays the DICOMDIR directory entries, according to the PATIENT, STUDY, SERIES, IMAGE paradigm.

If the DICOMDIR file is not found in the File-set, Free Image Importer is activated to choose individual files to import from the media.

3.3.1.2.1.1 Media Storage Application Profile for the RWA “Browse Media”

For the list of Application Profiles that invoke this AE for the Browse Media RWA, see the Table in Section 3.3.1

3.3.1.2.1.1.1 Options

Following are the SOP Classes supported by the RWA “Browse Media”:

Information Object Definition	SOP Class UID	Transfer Syntax	Transfer Syntax UID
Media Storage Directory Storage	1.2.840.10008.1.3.10	Explicit VR Little Endian	1.2.840.10008.1.2.1

3.3.1.2.2 Real-World Activity (RWA) “Restore Media”

The CD/DVD/USB DICOM Media Server AE acts as an FSR using the interchange option when requested to copy SOP instances from the media to the local database.

The user selects the SOP instances that he wants the CD/DVD/USB DICOM Media Server AE to copy on the local database by a drag and drop on the local browser icon or

by clicking on the suitable restore buttons. Once selected, the SOP instances are copied from the media to the local database.

Only, the SOP classes supported by the station are declared to the database in a transfer syntax supported by the station.

3.3.1.2.2.1 Media Storage Application Profile for the RWA “Restore Media”

For the list of Application Profiles that invoke this AE for the Restore Media RWA, see the Table in Section 3.3.1.

3.3.1.2.2.1.1 Options

Following are the SOP Classes and transfer syntaxes are supported by the RWA “Restore Media”:

Information Object Definition	SOP Class UID	Transfer Syntax Group
Computed Radiographic Image Storage	1.2.840.10008.5.1.4.1.1.1	Uncompressed Transfer Group
CT Image Storage	1.2.840.10008.5.1.4.1.1.2	
MR Image Storage	1.2.840.10008.5.1.4.1.1.4	
Xray Angiographic Image Storage	1.2.840.10008.5.1.4.1.1.12.1	Compressed Transfer Group
Xray Radiofluoroscopic Image Storage	1.2.840.10008.5.1.4.1.1.12.2	
Secondary Capture Image Storage	1.2.840.10008.5.1.4.1.1.7	
Digital X-Ray Image Storage - For Presentation	1.2.840.10008.5.1.4.1.1.1.1	
Digital X-Ray Image Storage - For Processing	1.2.840.10008.5.1.4.1.1.1.1.1	
Digital Mammography X-Ray Image Storage - For Presentation	1.2.840.10008.5.1.4.1.1.1.2	
Digital Mammography X-Ray Image Storage - For Processing	1.2.840.10008.5.1.4.1.1.1.2.1	
Nuclear Medicine Image Storage	1.2.840.10008.5.1.4.1.1.20	
Standalone Curve Storage	1.2.840.10008.5.1.4.1.1.9	
Positron Emission Tomography Image Storage	1.2.840.10008.5.1.4.1.1.128	
Standalone PET Curve Storage	1.2.840.10008.5.1.4.1.1.129	
RT Image Storage	1.2.840.10008.5.1.4.1.1.481.1	
RT Structure Set Storage	1.2.840.10008.5.1.4.1.1.481.3	
RT Plan Storage	1.2.840.10008.5.1.4.1.1.481.5	

GE Healthcare

DIR 5479848-1EN REV 1

NM Genie Private Data	1.2.840.113619.4.27	
PET Advance Private Data	1.2.840.113619.4.30	
GE Private DICOM 3D object	1.2.840.113619.4.26	
Ultrasound Image Storage	1.2.840.10008.5.1.4.1.1.6.1	
Ultrasound Multi-frame Image Storage	1.2.840.10008.5.1.4.1.1.3.1	
Ultrasound Image Storage (Retired)	1.2.840.10008.5.1.4.1.1.6	
Ultrasound Multi-frame Image Storage (Retired)	1.2.840.10008.5.1.4.1.1.3	
Basic Text SR	1.2.840.10008.5.1.4.1.1.88.11	
Enhanced SR	1.2.840.10008.5.1.4.1.1.88.22	
Comprehensive SR	1.2.840.10008.5.1.4.1.1.88.33	
Mammography CAD SR	1.2.840.10008.5.1.4.1.1.88.50	
Spatial Registration Storage	1.2.840.10008.5.1.4.1.1.66.1	
Key Object Selection Document Storage	1.2.840.10008.5.1.4.1.1.88.59	
X-Ray Radiation Dose SR Storage	1.2.840.10008.5.1.4.1.1.88.67	
Encapsulated PDF Storage	1.2.840.10008.5.1.4.1.1.104.1	

Note: SOP instances encoded with an encapsulated Transfer Syntax and which contain encapsulated Pixel Data (7FE0,0010) nested within a Sequence Data element are not copied on the local database.

Note: SOP instances encoded with an encapsulated Transfer Syntax and which contain the Digital Signatures Sequence (FFFA,FFFA) or the Data Set Trailing Padding attribute (FFFC,FFFC) are not copied on the local database.

Note: When copying on the local database a SOP instance encoded with a lossy encapsulated Transfer Syntax on the media, the SOP instance is copied using a non encapsulated Transfer Syntax and the Lossy Image Compression attribute (0028,2110) is added and set to “01”.

Note: Grayscale Softcopy Presentation State Storage (1.2.840.10008.5.1.4.1.1.11.1) and Blending Softcopy Presentation State Storage (1.2.840.10008.5.1.4.1.1.11.4) abstract syntax is received on network / read from media and some properties (image number, date/time, description and creator’s name) are displayed in the BROWSER but the basic Advantage Workstation 4.7 applications cannot display this object in a meaningful way (only black image is visible) and objects content is not taken into account while displaying the referenced images.

- Note:** SOP instances encoded with an encapsulated Transfer Syntax and which contain encapsulated Pixel Data (7FE0,0010) nested within a Sequence Data element are not copied on the local database.
- Note:** NM Genie Private Data (1.2.840.113619.4.27), PET Advance Private Data (1.2.840.113619.4.30) and GE Private DICOM 3D object (1.2.840.113619.4.26) Objects are expected as “IMAGE” directory record type.
- Note:** See **Table 2.3–1** for the list of transfer syntaxes available for the Transfer Syntax Group.

3.3.1.2.3 Real-World Activity (RWA) “Create Media”

The CD/DVD/USB DICOM Media Server AE acts as an FSC using the interchange option when requested to copy SOP Instances from the local database to one or multiple interchange media.

The user selects the entries in the local database that he wants the CD/DVD/USB DICOM Media Server AE to copy onto interchange media.

The graphic interface (CD/DVD/USB Composer) allows the user to select the entries in the local database to be copied onto one or more interchange media. He/she may

- Add patients, studies, series or images from the local database onto the CD/DVD/USB Composer
- Remove patients, studies, series or images from the CD/DVD/USB Composer.

The CD/DVD/USB Composer will create one File Set per generated interchange media.

The user has the opportunity to choose some options before composing the interchange media:

- The type of interchange media: to create: CD, DVD or USB
- The DICOM profile used for writing the interchange media. The user has the opportunity to choose:

- the “General Purpose option”

No images are compressed images on the media.

The following table lists the used media profile selected by Media Type in this case.

Interchange Media	Media profile used
CD	STD-GEN-CD
DVD	STD-GEN-DVD-JPEG
USB	STD-GEN-USB-JPEG

- the “Compress XA 512 Cardiac option”

XA 512x512 (8 bits) are always being saved compressed with JPEG lossless Process 14(1.2.840.10008.1.2.4.70).

The following table lists the used media profile selected by Media Type in this case.

Interchange Media	Only XA 512x512 (8 bits) images selected	Otherwise

CD	STD-XABC-CD	AUG-XABC-CD
DVD	STD-GEN-DVD-JPEG	STD-GEN-DVD-JPEG
USB	STD-GEN-USB-JPEG	STD-GEN-USB-JPEG

- Burn a DICOM Image Viewer along with the images (not for USB).
- Burn a DICOM SR Viewer along with the images (also for USB)
- Reduce the resolution of XA Cardiac images to 512x512x8bits. This procedure is the *downscan processing* and it manages images of the following resolutions: 1000x1000x8bits, 864x864x8bits, 800x800x8bits, 736x736x8bits and 608x608x8bits. The CD/DVD/USB DICOM Media Server AE will generate new images from the input images.

The user has the opportunity to choose some options after composing the interchange media:

- Read after write mode to check the binary integrity of what is written on the interchange media.
- Update the number of copies to generate.

The user has to insert blank CD/DVD disc or any FAT16/32 formatted USB device into the drive. Before writing the disc, the CD/DVD DICOM Media Server AE checks that the inserted media is blank and writable. If the condition is not met, an error is displayed and the disc is ejected.

Before writing to USB media the user has to choose the right partition on media. If the filesystem is not VFAT an error is displayed to the user.

Note: The corresponding SOP instances are set to the Explicit VR Little Endian transfer syntax and copied to the interchange media. Unknown Private Data Elements are encoded with the DICOM unknown Value Representation.

Note: Limitations: Because of resource allocation issues USB Media Composer cannot add more than 60.000 images in a session and maintain more than 300.000 images on the media in total.

3.3.1.2.3.1 Media Storage Application Profile for the RWA “Create Media”

This AE can use the following profiles for the RWA “Create Media”:

- STD-GEN-CD
- STD-XABC-CD
- AUG-XABC-CD
- STD-GEN-DVD-JPEG
- STD-GEN-USB-JPEG

Please refer to the Table in Section 3.3.1.

3.3.1.2.3.1.1 Options

Following are the SOP Classes supported by the RWA “Create Media”:

Information Object Definition	SOP Class UID	Transfer Syntax	Transfer Syntax UID
Media Storage Directory Storage	1.2.840.10008.1.3.10	Explicit VR Little Endian	1.2.840.10008.1.2.1
Computed Radiographic Image Storage	1.2.840.10008.5.1.4.1.1.1	Explicit VR Little Endian	1.2.840.10008.1.2.1
CT Image Storage	1.2.840.10008.5.1.4.1.1.2	Explicit VR Little Endian	1.2.840.10008.1.2.1
MR Image Storage	1.2.840.10008.5.1.4.1.1.4	Explicit VR Little Endian	1.2.840.10008.1.2.1
Xray Angiographic Image Storage	1.2.840.10008.5.1.4.1.1.12.1	Explicit VR Little Endian JPEG lossless Process 14 (selection value 1) for images 512x512 (8bits).	1.2.840.10008.1.2.1 1.2.840.10008.1.2.4.70 for images 512x512 (8bits).
Xray Radiofluoroscopic Image Storage	1.2.840.10008.5.1.4.1.1.12.2	Explicit VR Little Endian	1.2.840.10008.1.2.1
Secondary Capture Image Storage	1.2.840.10008.5.1.4.1.1.7	Explicit VR Little Endian	1.2.840.10008.1.2.1
Digital X-Ray Image Storage - For Presentation	1.2.840.10008.5.1.4.1.1.1.1	Explicit VR Little Endian	1.2.840.10008.1.2.1
Digital X-Ray Image Storage - For Processing	1.2.840.10008.5.1.4.1.1.1.1.1	Explicit VR Little Endian	1.2.840.10008.1.2.1
Digital Mammography X-Ray Image Storage - For Presentation	1.2.840.10008.5.1.4.1.1.1.2	Explicit VR Little Endian	1.2.840.10008.1.2.1
Digital Mammography X-Ray Image Storage - For Processing	1.2.840.10008.5.1.4.1.1.1.2.1	Explicit VR Little Endian	1.2.840.10008.1.2.1
Nuclear Medicine Image Storage	1.2.840.10008.5.1.4.1.1.20	Explicit VR Little Endian	1.2.840.10008.1.2.1
Standalone Curve Storage	1.2.840.10008.5.1.4.1.1.9	Explicit VR Little Endian	1.2.840.10008.1.2.1
Positron Emission Tomography Image Storage	1.2.840.10008.5.1.4.1.1.128	Explicit VR Little Endian	1.2.840.10008.1.2.1
Standalone PET Curve Storage	1.2.840.10008.5.1.4.1.1.129	Explicit VR Little Endian	1.2.840.10008.1.2.1
RT Image Storage	1.2.840.10008.5.1.4.1.1.481.1	Explicit VR Little Endian	1.2.840.10008.1.2.1
RT Structure Set Storage	1.2.840.10008.5.1.4.1.1.481.3	Explicit VR Little Endian	1.2.840.10008.1.2.1
RT Plan Storage	1.2.840.10008.5.1.4.1.1.481.5	Explicit VR Little Endian	1.2.840.10008.1.2.1
GE Private DICOM 3D object	1.2.840.113619.4.26	Explicit VR Little Endian	1.2.840.10008.1.2.1

Ultrasound Image Storage	1.2.840.10008.5.1.4.1.1.6.1	Explicit VR Little Endian	1.2.840.10008.1.2.1
Ultrasound Multi-frame Image Storage	1.2.840.10008.5.1.4.1.1.3.1	Explicit VR Little Endian	1.2.840.10008.1.2.1
Ultrasound Image Storage (Retired)	1.2.840.10008.5.1.4.1.1.6	Explicit VR Little Endian	1.2.840.10008.1.2.1
Ultrasound Multi-frame Image Storage (Retired)	1.2.840.10008.5.1.4.1.1.3	Explicit VR Little Endian	1.2.840.10008.1.2.1
Basic Text SR	1.2.840.10008.5.1.4.1.1.88.11	Explicit VR Little Endian	1.2.840.10008.1.2.1
Enhanced SR	1.2.840.10008.5.1.4.1.1.88.22	Explicit VR Little Endian	1.2.840.10008.1.2.1
Comprehensive SR	1.2.840.10008.5.1.4.1.1.88.33	Explicit VR Little Endian	1.2.840.10008.1.2.1
Mammography CAD SR	1.2.840.10008.5.1.4.1.1.88.50	Explicit VR Little Endian	1.2.840.10008.1.2.1
Spatial Registration Storage	1.2.840.10008.5.1.4.1.1.66.1	Explicit VR Little Endian	1.2.840.10008.1.2.1
Key Object Selection Document Storage	1.2.840.10008.5.1.4.1.1.88.59	Explicit VR Little Endian	1.2.840.10008.1.2.1
Encapsulated PDF Storage	1.2.840.10008.5.1.4.1.1.104.1	Explicit VR Little Endian	1.2.840.10008.1.2.1

Note: If the “Compress XA 512 Cardiac option” (AUG-XABC-CD for CDs, STD-GEN-DVD-JPEG for DVDs and STD-GEN-USB-JPEG for USBs) has been chosen by the user, Xray Angiographic Instances which contain Pixel Data (7FE0,0010) nested within a Sequence Data element are not copied onto the CD/DVD/USB.

Note: If the “Compress XA 512 Cardiac option” (AUG-XABC-CD for CDs, STD-GEN-DVD-JPEG for DVDs and STD-GEN-USB-JPEG for USBs) has been chosen by the user, Xray Angiographic Instances which contain the Data Set Trailing Padding attribute (FFFC,FFFC) are not copied onto the CD/DVD/USB.

Note: Grayscale Softcopy Presentation State Storage (1.2.840.10008.5.1.4.1.1.11.1) and Blending Softcopy Presentation State Storage (1.2.840.10008.5.1.4.1.1.11.4) abstract syntax can be written on any media. The referenced images are not pulled automatically.

Note: For NM Genie Private Data (1.2.840.113619.4.27), PET Advance Private Data (1.2.840.113619.4.30) and GE Private DICOM 3D object (1.2.840.113619.4.26) Objects “IMAGE” directory record type is created.

Note: NM Genie Private Data (1.2.840.113619.4.27) and PET Advance Private Data (1.2.840.113619.4.30) can be written only on CD only with STD-GEN-CD Application Profile with Explicit VR Little Endian (1.2.840.10008.1.2.1) transfer syntax.

3.4 AUGMENTED AND PRIVATE APPLICATION PROFILES

One augmented profile is defined to create a CD of XA 512x512 (8bits) images along with other SOP Classes. This profile is defined as the AUG-XABC-CD Application Profile.

3.4.1 Augmented Application Profiles

3.4.1.1 Augmented Application Profile AUG-XABC-CD

The AE defines the augmented profile AUG-XABC-CD derived from the STD-XABC-CD profile.

3.4.1.1.1 SOP Class Augmentations

Information Object Definition	SOP Class UID	Transfer Syntax	Transfer Syntax UID
Computed Radiographic Image Storage	1.2.840.10008.5.1.4.1.1.1	Explicit VR Little Endian	1.2.840.10008.1.2.1
CT Image Storage	1.2.840.10008.5.1.4.1.1.2	Explicit VR Little Endian	1.2.840.10008.1.2.1
MR Image Storage	1.2.840.10008.5.1.4.1.1.4	Explicit VR Little Endian	1.2.840.10008.1.2.1
XRay Angiographic Image Storage	1.2.840.10008.5.1.4.1.1.12.1	JPEG lossless Process 14 (selection value 1) for images 512x512 (8bits). Explicit VR Little Endian for other XA images	1.2.840.10008.1.2.4.70 for images 512x512 (8bits). 1.2.840.10008.1.2.1 for other XA images
Xray Radiofluoroscopic Image Storage	1.2.840.10008.5.1.4.1.1.12.2	Explicit VR Little Endian	1.2.840.10008.1.2.1
Secondary Capture Image Storage	1.2.840.10008.5.1.4.1.1.7	Explicit VR Little Endian	1.2.840.10008.1.2.1
Digital X-Ray Image Storage - For Presentation	1.2.840.10008.5.1.4.1.1.1.1	Explicit VR Little Endian	1.2.840.10008.1.2.1
Digital X-Ray Image Storage - For Processing	1.2.840.10008.5.1.4.1.1.1.1.1	Explicit VR Little Endian	1.2.840.10008.1.2.1
Digital Mammography X-Ray Image Storage - For Presentation	1.2.840.10008.5.1.4.1.1.1.2	Explicit VR Little Endian	1.2.840.10008.1.2.1
Digital Mammography X-Ray Image Storage - For Processing	1.2.840.10008.5.1.4.1.1.1.2.1	Explicit VR Little Endian	1.2.840.10008.1.2.1
Nuclear Medicine Image Storage	1.2.840.10008.5.1.4.1.1.20	Explicit VR Little Endian	1.2.840.10008.1.2.1

**VS7 – ADVANTAGE WORKSTATION 4.7
DICOM CONFORMANCE STATEMENT**

GE Healthcare

DIR 5479848-1EN REV 1

Standalone Curve Storage	1.2.840.10008.5.1.4.1.1.9	Explicit VR Little Endian	1.2.840.10008.1.2.1
Positron Emission Tomography Image Storage	1.2.840.10008.5.1.4.1.1.128	Explicit VR Little Endian	1.2.840.10008.1.2.1
Standalone PET Curve Storage	1.2.840.10008.5.1.4.1.1.129	Explicit VR Little Endian	1.2.840.10008.1.2.1
RT Image Storage	1.2.840.10008.5.1.4.1.1.481.1	Explicit VR Little Endian	1.2.840.10008.1.2.1
RT Structure Set Storage	1.2.840.10008.5.1.4.1.1.481.3	Explicit VR Little Endian	1.2.840.10008.1.2.1
RT Plan Storage	1.2.840.10008.5.1.4.1.1.481.5	Explicit VR Little Endian	1.2.840.10008.1.2.1
NM Genie Private Data	1.2.840.113619.4.27	Explicit VR Little Endian	1.2.840.10008.1.2.1
PET Advance Private Data	1.2.840.113619.4.30	Explicit VR Little Endian	1.2.840.10008.1.2.1
GE Private DICOM 3D object	1.2.840.113619.4.26	Explicit VR Little Endian	1.2.840.10008.1.2.1
Ultrasound Image Storage	1.2.840.10008.5.1.4.1.1.6.1	Explicit VR Little Endian	1.2.840.10008.1.2.1
Ultrasound Multi-frame Image Storage	1.2.840.10008.5.1.4.1.1.3.1	Explicit VR Little Endian	1.2.840.10008.1.2.1
Ultrasound Image Storage (Retired)	1.2.840.10008.5.1.4.1.1.6	Explicit VR Little Endian	1.2.840.10008.1.2.1
Ultrasound Multi-frame Image Storage (Retired)	1.2.840.10008.5.1.4.1.1.3	Explicit VR Little Endian	1.2.840.10008.1.2.1
Basic Text SR	1.2.840.10008.5.1.4.1.1.88.11	Explicit VR Little Endian	1.2.840.10008.1.2.1
Enhanced SR	1.2.840.10008.5.1.4.1.1.88.22	Explicit VR Little Endian	1.2.840.10008.1.2.1
Comprehensive SR	1.2.840.10008.5.1.4.1.1.88.33	Explicit VR Little Endian	1.2.840.10008.1.2.1
Mammography CAD SR	1.2.840.10008.5.1.4.1.1.88.50	Explicit VR Little Endian	1.2.840.10008.1.2.1
Spatial Registration Storage	1.2.840.10008.5.1.4.1.1.66.1	Explicit VR Little Endian	1.2.840.10008.1.2.1
Key Object Selection Document Storage	1.2.840.10008.5.1.4.1.1.88.59	Explicit VR Little Endian	1.2.840.10008.1.2.1
Encapsulated PDF Storage	1.2.840.10008.5.1.4.1.1.104.1	Explicit VR Little Endian	1.2.840.10008.1.2.1

3.4.1.1.2 Directory Augmentations

AUG-XABC-CD Application Profile is implemented and built on STD-XABC-CD Profile with the following keys are added as Type 3 data elements in the Basic Directory IOD compared to the base STD-XABC-CD Application Profile.

Key Attribute	Tag	Directory Record Type
Patient's Birth Date	(0010,0030)	PATIENT
Patient's Sex	(0010,0040)	PATIENT
Series Description	(0008,103E)	SERIES
Manufacturer	(0008,1090)	SERIES
Institution Name	(0008,0080)	SERIES
Institution Address	(0008,0081)	SERIES
Attending Physician's Name	(0008,1050)	SERIES
Image Type	(0008,0008)	IMAGE
Image Date	(0008,0023)	IMAGE
Image Time	(0008, 0033)	IMAGE
Recommended Display Frame Rate	(0008,2144)	IMAGE
Radiation Settings	(0018,1155)	IMAGE (See Note below)
Image Comments	(0020,4000)	IMAGE
Number Of Frames	(0028,0008)	IMAGE
Rows	(0028,0010)	IMAGE
Columns	(0028,0011)	IMAGE

Note: Radiation Settings can be valued for XA and RF images only.

The XA images having the following attributes can be *downscanned* to 512x512x8bits:

- SOP Class UID (0008,0016) is “1.2.840.10008.5.1.4.1.1.12.1”.
 - The “Can Downscan 512” private attribute (0019,xxAA, GEMS_DL_IMG_01) can be found in the data set, and its value is “YES”
- or
- the “Can Downscan 512” private attribute (0019,xxAA, GEMS_DL_IMG_01) cannot be found in the data set and Manufacturer (0008,0070) is “GE MEDICAL SYSTEMS” and the Manufacturer’s Model Name (0008,1090) is “DL”
- Bits Allocated (0028,0100) is equal to 8.
 - Bits Stored (0028,0101) is less than or equal to 8.

GE Healthcare

DIR 5479848-1EN REV 1

- Rows (0028,0010) and Columns (0028,0011) attributes have the following values: 1000 x 1000 or 864 x 864 or 800 x 800 or 736 x 736 or 608x608.

All other images cannot be processed. Please refer to section 12 for more information about the downscan.

Note: The meaning of (0019,xxAA, GEMS_DL_IMG_01) is the private element (0019,xxAA) associated with the Private Creator Identification is GEMS_DL_IMG_01.

3.4.1.1.3 Other Augmentations

No Other Augmentations are implemented.

3.4.2 Private Application Profiles

None.

3.5 EXTENSIONS / SPECIALIZATIONS / PRIVATIZATIONS

3.5.1 Standard Extended / Specialized / Private SOP Classes

3.5.1.1 Standard Extended SOP Classes

The product provides Standard Extended Conformance to all supported SOP Classes, through the inclusion of additional Type 3 Data Elements for each supported profile. The extensions are defined in sections 5.2.2.

3.5.1.2 Private SOP Class NM Genie Private Data

GE private DICOM NM images are described in the GENIE DCS, see 1.6 - References

3.5.1.3 Private SOP Class PET Advance Private Data

GE private DICOM PET images are described in the ADV DCS, see 1.6 - References

3.5.1.4 Private SOP Class GE Private DICOM 3D object

GE Private 3D Model Objects are described in the AW VXTL DCS, see 1.6 - References

3.5.2 Private Transfer Syntaxes

No private Transfer Syntax is written on media by the described CD/DVD/USB DICOM SERVER AE of Advantage Workstation 4.7.

3.6 CONFIGURATION

The source AE Title encoded in the File Meta-Information cannot be modified.

3.7 SUPPORT OF EXTENDED CHARACTER SETS

The Advantage Workstation supports extended character sets as specified in Section 2.7, Support of Extended Character Sets of Networking.

4. STORAGE COMMITMENT PUSH MODEL IMPLEMENTATION

4.1 STORAGE COMMITMENT PUSH MODEL INFORMATION OBJECT DEFINITION

Please refer to DICOM Part 3 (Information Object Definitions) for a description of each of the attributes contained within the Storage Commitment Information Object.

The Storage Commitment Information Object is used both for N-ACTION Storage Commitment Requests by the SCU and N-EVENT-REPORT Storage Commitment Notifications by the SCP.

4.1.1 STORAGE COMMITMENT MODULE FOR N-ACTION

TABLE 4-1 STORAGE COMMITMENT MODULE FOR N-ACTION

Attribute Name	Tag	SCU Use
Transaction UID	(0008,1195)	Uses the UID generation service provided by the platform, the algorithm depends on the <ul style="list-style-type: none"> • UID root of the product (1.2.840.113619.2.350) • MAC Address of the workstation • Unix Process identifier • Date and time.
Storage Media File-Set ID	(0088,0130)	Not used
Storage Media File-Set UID	(0088,0140)	Not used
Referenced SOP Sequence	(0008,1199)	
>Referenced SOP Class UID	(0008,1150)	
>Referenced SOP Instance UID	(0008,1155)	
>Storage Media File-Set ID	(0088,0130)	Not used
>Storage Media File-Set UID	(0088,0140)	Not used

4.1.2 STORAGE COMMITMENT MODULE FOR N-EVENT-REPORT

E 4-2 STORAGE COMMITMENT MODULE FOR N-EVENT-REPORT

Attribute Name	Tag	SCU Use
Transaction UID	(0008,1195)	Not used
Retrieve AE Title	(0008,0054)	Not used
Storage Media File-Set ID	(0088,0130)	Not used
Storage Media File-Set UID	(0088,0140)	Not used

Referenced SOP Sequence	(0008,1199)	Success of storage commitment is registered in the database. If images are removed in the meanwhile the report is ignored.
>Referenced SOP Class UID	(0008,1150)	
>Referenced SOP Instance UID	(0008,1155)	
>Retrieve AE Title	(0008,0054)	Not used
>Storage Media File-Set ID	(0088,0130)	Not used
>Storage Media File-Set UID	(0088,0140)	Not used
Failed SOP Sequence	(0008,1198)	Failure and reason is logged. A general failure is reported to the user.
>Referenced SOP Class UID	(0008,1150)	
>Referenced SOP Instance UID	(0008,1155)	
>Failure Reason	(0008,1197)	See Section 4.1.2.1 for the list of processed values.

4.1.2.1 Processing of Failure Reason when received in a N-Event-Report

When receiving a N-Event-Report request with a Event Type ID equal to 2, meaning that Storage Commitment is complete, but failure exists, following is the set of value that this Storage Commitment SCU AE is able to process:

Failure Reason	Meaning	Application Behavior When Receiving Reason Code
0110H	Processing failure	Failure and reason is logged. A general failure is reported to the user.
0112H	No such object instance	
0213H	Resource limitation	
0122H	Referenced SOP Class not supported	
0119H	Class / Instance conflict	
0131H	Duplicate transaction UID	
*	Other Failure Reason code values	

5. BASIC DIRECTORY INFORMATION OBJECT IMPLEMENTATION

5.1 IOD MODULE TABLE

Table 5-1 identifies the defined modules within the entities which comprise the Basic Directory IOD. Modules are identified by Module Name.

See DICOM Part 3 for a complete definition of the entities, modules, and attributes.

TABLE 5-1 BASIC DIRECTORY IOD MODULES

Module Name	Reference
File Set Identification	5.2.1
Directory Information	5.2.2

FSC of this implementation creates a Directory Information Module and FSR supports it.

5.2 INFORMATION MODULE DEFINITIONS

Please refer to DICOM Standard Part 3 (Information Object Definitions) for a description of each of the modules and directory records contained within the Basic Directory Information Object.

The following modules are included to convey Enumerated Values, Defined Terms, and Optional Attributes supported. Type 1 & Type 2 Attributes are also included for completeness and to define what values they may take and where these values are obtained from. It should be noted that they are the same ones as defined in the DICOM Standard Part 3 (Information Object Definitions). Also note that Attributes not present in tables are not supported.

5.2.1 File Set identification Module

TABLE 5-2 FILE-SET IDENTIFICATION MODULE

Attribute Name	Tag	Type	Attribute Description
File-set ID	(0004,1130)	2	The value is created as follows: GEMS_<day of month>_<month>_<year>, for example: GEMS_20_10_2010
File-set Descriptor File ID	(0004,1141)	1C	Not used by FSR and not filled by FSC.
Specific Character Set of File-set Descriptor File	(0004,1142)	1C	Not used by FSR and not filled by FSC.

5.2.2 Directory Information Module

TABLE 5-3 DIRECTORY INFORMATION MODULE

Attribute Name	Tag	Type	Attribute Description
----------------	-----	------	-----------------------

Offset of the First Directory Record of the Root Directory Entity	(0004,1200)	1	
Offset of the Last Directory Record of the Root Directory Entity	(0004,1202)	1	
File-set Consistency Flag	(0004,1212)	1	FSC sets the value: 0000H: no known inconsistencies
Directory Record Sequence	(0004,1220)	2	FSC creates items in Directory Records sequence.
>Offset of the Next Directory Record	(0004,1400)	1C	
>Record In-use Flag	(0004,1410)	1C	FSC sets only: FFFFH: record is in use Inactive records are not used (0000H)
>Offset of Referenced Lower-Level Directory Entity	(0004,1420)	1C	
>Directory Record Type	(0004,1430)	1C	The following values are supported by FSR, FSC: PATIENT STUDY SERIES IMAGE RT DOSE RT STRUCTURE SET RT PLAN SR DOCUMENT KEY OBJECT DOC REGISTRATION ENCAP DOC CURVE
>Private Record UID	(0004,1432)	1C	No private Records are created
>Referenced File ID	(0004,1500)	1C	Filename is generated to be unique on the media like: DICOM<postfix letters>\PA<number of patient>\ST<number of study>\SE<number of series>\IM<number of image> Field is included if Directory Record Type is not PATIENT/STUDY/SERIES.
>Referenced SOP Class UID in File	(0004,1510)	1C	Field is included if Directory Record Type is not PATIENT/STUDY/SERIES.
>Referenced SOP Instance UID in File	(0004,1511)	1C	Field is included if Directory Record Type is not PATIENT/STUDY/SERIES.
>Referenced Transfer Syntax UID in File	(0004,1512)	1C	Field is included if Directory Record Type is not PATIENT/STUDY/SERIES.
> Referenced Related General SOP Class UID in File	(0004,151A)	1C	Field is included if Directory Record Type is not PATIENT/STUDY/SERIES.
>Record Selection Keys			See Note:.

Note: A postfix letter for Referenced File ID can be the English alphabetical characters: A-Z. The first not used directory name is searched in the following order:

“DICOM”, “DICOMA”, “DICOMB”, ... “DICOMZ”, “DICOMAA”,
 “DICOMAB”, ..., “DICOMAZ”,

5.2.3 Definition of Specific Directory Records

5.2.3.1 Patient Directory Record Definition

TABLE 5-4 PATIENT KEYS

Key	Tag	Type	Attribute Description
Specific Character Set	(0008,0005)	1C	FSC copies this value from the first instance of the patient. FSR supports all character sets.
Patient's Name	(0010,0010)	2	<p>FSC copies this value from the first instance of the patient.</p> <p>The patient name in the referenced object instances may be different if Advantage Workstation is configure not to use the patient name in the patient key. In this case multiple different patient names can be in the referenced objects since the original value is kept in the files.</p> <p>FSR uses the patient name from this attribute to show to the user what he would like to restore. When the objects are copied to the database the and shown in the local patient list the value is read from the referenced object instances.</p>
Patient ID	(0010,0020)	1	<p>FSC copies this value from the first instance of the patient.</p> <p>The patient id in the referenced object instances may be different if the referenced object instance holds an empty value. In this case this attribute will be “NOID” and the referenced file will contain an empty value.</p> <p>FSR uses the patient id from this attribute to show to the user what he would like to restore. When the objects are copied to the database the and shown in the local patient list the value is read from the referenced object instances.</p>

Patient's Birth Date	(0010,0030)	<p>STD-GEN-CD: 3</p> <p>STD-XABC-CD, AUG-XABC-CD: 2</p> <p>STD-GEN-DVD-JPEG, STD-GEN-USB-JPEG: 1C</p>	<p>FSC copies this value from the first instance of the patient.</p> <p>The patient birth date in the referenced object instances may be different if Advantage Workstation is configure not to use the patient birth date in the patient key. In this case multiple different patient birth dates can be in the referenced objects since the original value is kept in the files.</p> <p>For STD-XABC-CD and AUG-XABC-CD profiles this value always present with non empty value.</p> <p>For STD-GEN-DVD-JPEG and STD-GEN-USB-JPEG profiles this value is 1C: present and non empty if referenced dataset contains it.</p> <p>FSR does not use the value from this attribute to show to the user. When the objects are copied to the database the and shown in the local patient list the value is read from the referenced object instances.</p>
Patient's Sex	(0010,0040)		<p>FSC copies this value from the first instance of the patient.</p> <p>The patient sex in the referenced object instances may be different if Advantage Workstation is configure not to use the patient birth date in the patient key. In this case multiple different patient sexes can be in the referenced objects since the original value is kept in the files.</p> <p>For STD-XABC-CD and AUG-XABC-CD profiles this value always present with non empty value.</p> <p>For STD-GEN-DVD-JPEG and STD-GEN-USB-JPEG profiles this value is 1C: present and non empty if referenced dataset contains it.</p> <p>FSR does not use the value from this attribute to show to the user. When the objects are copied to the database the and shown in the local patient list the value is read from the referenced object instances.</p>

TABLE 5-5 EXTENDED PATIENT KEYS FOR STD-GEN-CD PROFILE

Key	Tag	Type	Attribute Description
Patient's Birth Date	(0010,0030)	2	For STD-GEN-CD profile this value is always present and may be empty.
Patient's Sex	(0010,0040)	2	For STD-GEN-CD profile this value is always present and may be empty.

TABLE 5-6 STUDY KEYS

Key	Tag	Type	Attribute Description
Specific Character Set	(0008,0005)	1C	FSC copies this value from the first instance of the study. FSR supports all character sets.
Study Date	(0008,0020)	1	<p>FSC sets this value from the first instance of the study in the following order if the value is empty:</p> <ul style="list-style-type: none"> • Study Date (0008,0020) • Series Date (0008,0021) • Acquisition Date (0008,0022) • Date of Secondary Capture (0018,1012) • Structure Set Date (3006,0008) • RT Plan Date (300A,0006) • Content Date (0008,0023) • Presentation Creation Date (0070,0082) • Instance Creation Date (0008,0012) <p>If the Study Date cannot be determined by these fields the study cannot be written on the media.</p>
Study Time	(0008,0030)	1	<p>FSC sets this value from the first instance of the study in the following order if the value is empty:</p> <ul style="list-style-type: none"> • Study Time (0008,0030) • Series Time (0008,0031) • Acquisition Time (0008,0032) • Time of Secondary Capture (0018,1014) • Structure Set Time (3006,0009) • RT Plan Time (300A,0007) • Content Time (0008,0033) • Presentation Creation Time (0070,0083) • Instance Creation Time (0008,0013) <p>If the Study Time cannot be determined by these fields the study cannot be written on the media.</p>
Study Description	(0008,1030)	2	<p>Filled by FSC from (0008,1030) from the first instance of the study. Used by an FSR to display the field in the Media Patient List.</p>
Study Instance UID	(0020,000D)	1C	Always used rather than (0004,1511), read from the first image from the study.

Study ID	(0020,0010)	1	Filled by FSC from (0020,0010) from the first instance of the study or “NOID” if not the field is empty.
Accession Number	(0008,0050)	2	Filled by an FSC from (0008,0050) from the first instance of the study. Used by an FSR to display the field in the Media Patient List.

5.2.3.3 Series Directory Record Definition

TABLE 5-7 SERIES KEYS

Key	Tag	Type	Attribute Description
Specific Character Set	(0008,0005)	1C	FSC copies this value from the first instance of the series. FSR supports all character sets.
Modality	(0008,0060)	1	If a series has empty modality (0008,0060) than the series cannot be written on media.
Series Instance UID	(0020,000E)	1	
Series Number	(0020,0011)	1	If a series has empty series number (0020,0011) than the series cannot be written on media.
Icon Image Sequence	(0088,0200)	3	This implementation does not support Icon Image Sequence at series level.
Body Part Examined	(0018,0015)	3	FSC copies this value from the first instance of the series. FSR does not use the value from this attribute to show to the user.

TABLE 5-8 ADDITIONAL SERIES KEYS FOR STD-XABC-CD, AUG-XABC-CD, DVD-JPEG AND STD-GEN-USB-JPEG PROFILES

Key	Tag	Type	Attribute Description
Institution Name	(0008,0080)	STD-GEN-DVD-JPEG, STD-GEN-USB-JPEG: 1C	FSC copies this value from the first instance of the series. FSR does not use the value from this attribute to show to the user.
Institution Address	(0008,0081)	STD-XABC-CD, AUG-XABC-CD: 2	FSC copies this value from the first instance of the series. FSR does not use the value from this attribute to show to the user.
Performing Physicians' Name	(0008,1050)		FSC copies this value from the first instance of the series. FSR does not use the value from this attribute to show to the user.

5.2.3.4 Image Directory Record Definition

TABLE 5-9 IMAGE KEYS

Key	Tag	Type	Attribute Description
Specific Character Set	(0008,0005)	1C	FSC copies this value from the image. FSR supports all character sets.
Instance Number	(0020,0013)	1	An image without instance number cannot be written on the media.

TABLE 5-10 ADDITIONAL IMAGE KEYS FOR STD-GEN-DVD-JPEG AND STD-GEN-USB-JPEG PROFILES

Key	Tag	Type	Attribute Description
Image Type	(0008,0008)	1C	FSC copies this value from the image if present and not empty. FSR displays the value from this attribute to the user.
Calibration Image	(0050,0004)	1C	FSC copies this value from the image if present and not empty. FSR does not use the value from this attribute to show to the user.
Referenced Image Sequence	(0008,1140)	1C	FSC copies this value from the image if present and not empty. FSR does not use the value from this attribute to show to the user.
Lossy Image Compression Ratio	(0028,2112)	1C	FSC copies this value from the image if present and not empty. FSR does not use the value from this attribute to show to the user.
Rows	(0028,0010)	1	FSC copies this value from the image. If the value is not defined or empty the image cannot be written on the media. FSR does not use the value from this attribute to show to the user.
Columns	(0028,0011)	1	FSC copies this value from the image. If the value is not defined or empty the image cannot be written on the media. FSR does not use the value from this attribute to show to the user.

Frame of Reference UID	(0020,0052)	1C	FSC copies this value from the image if present and not empty. If the value defined but empty the image cannot be written on the media. FSR does not use the value from this attribute to show to the user.
Synchronization Frame of Reference UID	(0020,0200)	1C	FSC copies this value from the image if present and not empty. If the value defined but empty the image cannot be written on the media. FSR does not use the value from this attribute to show to the user.
Number of Frames	(0028,0008)	1C	FSC copies this value from the image if present and not empty. If the value defined but empty the image cannot be written on the media. FSR does not use the value from this attribute to show to the user.
Acquisition Time Synchronized	(0018,1800)	1C	FSC copies this value from the image if present and not empty. If the value defined but empty the image cannot be written on the media. FSR does not use the value from this attribute to show to the user.
Acquisition Datetime	(0008,002A)	1C	FSC copies this value from the image if present and not empty. If the value defined but empty the image cannot be written on the media. FSR does not use the value from this attribute to show to the user.
Image Position (Patient)	(0020,0032)	1C	FSC copies this value from the image if present and not empty. If the value defined but empty the image cannot be written on the media. FSR does not use the value from this attribute to show to the user.
Image Orientation (Patient)	(0020,0037)	1C	FSC copies this value from the image if present and not empty. If the value defined but empty the image cannot be written on the media. FSR does not use the value from this attribute to show to the user.
Pixel Spacing	(0028,0030)	1C	FSC copies this value from the image if present and not empty. If the value defined but empty the image cannot be written on the media. FSR does not use the value from this attribute to show to the user.

TABLE 5-11 ADDITIONAL IMAGE KEYS FOR STD-XABC-CD AND AUG-XABC-CD PROFILES

Key	Tag	Type	Attribute Description
Icon Image Sequence	(0088,0200)	1	FSR does no use icon image sequence.
Image Type	(0008,0008)	1	FSC copies this value from the image. FSR displays the value from this attribute to the user.

Calibration Image	(0050,0004)	2	FSC copies this value from the image. If the value is not defined the image cannot be written on the media. FSR does not use the value from this attribute to show to the user.
Referenced Image Sequence	(0008,1140)	1C	FSC copies this value from the image if Image Type is of BIPLANE A or BIPLANE B. FSR does not use the value from this attribute to show to the user.
>Referenced SOP Class UID	(0008,1150)	1C	FSC copies this value from the image if Image Type is of BIPLANE A or BIPLANE B. FSR does not use the value from this attribute to show to the user.
>Referenced SOP Instance UID	(0008,1155)	1C	FSC copies this value from the image if Image Type is of BIPLANE A or BIPLANE B. FSR does not use the value from this attribute to show to the user.

TABLE 5-12
ADDITIONAL IMAGE KEYS FOR STD-GEN-CD

Key	Tag	Type	Attribute Description
Image Type	(0008,0008)	1C	FSC copies this value from the image. FSR displays the value from this attribute to the user.
Referenced Image Sequence	(0008,1140)	1C	FSC copies this value from the image if present and not empty. FSR does not use the value from this attribute to show to the user.
>Referenced SOP Class UID	(0008,1150)	1C	FSC copies this value from the image if Referenced Image Sequence is present. FSR does not use the value from this attribute to show to the user.
>Referenced SOP Instance UID	(0008,1155)	1C	FSC copies this value from the image if Referenced Image Sequence is present. FSR does not use the value from this attribute to show to the user.

5.2.3.4.1 Icon Image Key Definition

- Icons are created from the original XA images by downsampling it to 128x128. The key frame number is read from DICOM Tag “Representative Frame Number” (0028,1060) if present, otherwise calculated by max(1, frame count/3).
- MONOCHROME 1 and 2 Photometric Interpretations (0028,0004) are created
- Size is 128x128

- Bits Allocated (0028,0100) and Bits Stored (0028,0101) is 8
- High Bit is 7

5.2.3.5 RT Dose Directory Record Definition

TABLE 5-13 RT DOSE KEYS

Key	Tag	Type	Attribute Description
Specific Character Set	(0008,0005)	1C	FSC copies this value from the first instance of the series. FSR supports all character sets.
Instance Number	(0020,0013)	1	An image without instance number cannot be written on the media.
Dose Summation Type	(3004,000A)	1	
Icon Image Sequence	(0088,0200)	3	This implementation does not support Icon Image Sequence for RT Dose.

5.2.3.6 RT Structure Set Directory Record Definition

TABLE 5-14 RT STRUCTURE SET KEYS

Key	Tag	Type	Attribute Description
Specific Character Set	(0008,0005)	1C	FSC copies this value from the first instance of the series. FSR supports all character sets.
Instance Number	(0020,0013)	1	An image without instance number cannot be written on the media.
Structure Set Label	(3006,0002)	1	
Structure Set Date	(3006,0008)	2	
Structure Set Time	(3006,0009)	2	

5.2.3.7 RT Plan Directory Record Definition

TABLE 5-15 RT PLAN KEYS

Key	Tag	Type	Attribute Description
Specific Character Set	(0008,0005)	1C	FSC copies this value from the first instance of the series. FSR supports all character sets.
Instance Number	(0020,0013)	1	An image without instance number cannot be written on the media.
RT Plan Label	(300A,0002)	1	
RT Plan Date	(300A,0006)	2	
RT Plan Time	(300A,0007)	2	

5.2.3.8 Presentation State Directory Record Definition

TABLE 5-16 PRESENTATION KEYS

Key	Tag	Type	Attribute Description
Specific Character Set	(0008,0005)	1C	FSC copies this value from the first instance of the series. FSR supports all character sets.
Presentation Creation Date	(0070,0082)	1	
Presentation Creation Time	(0070,0083)	1	
Instance Number	(0020,0013)	1	An image without instance number cannot be written on the media.
Content Label	(0070,0080)	1	
Content Description	(0070,0081)	2	
Content Creator's Name	(0070,0084)	2	
Referenced Series Sequence	(0008,1115)	1C	
>Series Instance UID	(0020,000E)	1	
>Referenced Image Sequence	(0008,1140)	1	
<i>>>Include 'SOP Instance Reference Macro'</i>			
Blending Sequence	(0070,0402)	1C	
>Study Instance UID	(0020,000D)	1	
>Referenced Series Sequence	(0008,1115)	1	
>>Series Instance UID	(0020,000E)	1	
>>Referenced Image Sequence	(0008,1140)	1	
<i>>>>Include 'SOP Instance Reference Macro'</i>			

GE Healthcare

DIR 5479848-1EN REV 1

5.2.3.9 SR Document Directory Record Definition

TABLE 5-17 SR DOCUMENT KEYS

Key	Tag	Type	Attribute Description
Specific Character Set	(0008,0005)	1C	FSC copies this value from the first instance of the series. FSR supports all character sets.
Instance Number	(0020,0013)	1	An image without instance number cannot be written on the media.
Completion Flag	(0040,A491)	1	
Verification Flag	(0040,A493)	1	
Content Date	(0008,0023)	1	
Content Time	(0008,0033)	1	
Verification DateTime	(0040,A030)	1C	The latests datetime found in the verifying observer sequence.
Concept Name Code Sequence	(0040,A043)	1	
<i>>Include 'Code Sequence Macro'</i>			
Content Sequence	(0040,A730)	1C	
>Relationship Type	(0040,A010)	1	All "HAS CONCEPT MOD" relationship type are copied into the sequence of the SR Tree.
<i>>Include 'Document Content Macro'</i>			

5.2.3.10 Key Object Document Directory Record Definition

TABLE 5-18 KEY OBJECT DOCUMENT KEYS

Key	Tag	Type	Attribute Description
Specific Character Set	(0008,0005)	1C	FSC copies this value from the first instance of the series. FSR supports all character sets.
Instance Number	(0020,0013)	1	An image without instance number cannot be written on the media.
Content Date	(0008,0023)	1	
Content Time	(0008,0033)	1	
Concept Name Code Sequence	(0040,A043)	1	
<i>>Include 'Code Sequence Macro'</i>			
Content Sequence	(0040,A730)	1C	
>Relationship Type	(0040,A010)	1	All "HAS CONCEPT MOD" relationship type are copied into the sequence of the SR Tree.
<i>>Include 'Document Content Macro'</i>			

GE Healthcare

DIR 5479848-1EN REV 1

5.2.3.11 Registration Directory Record Definition

TABLE 5-19 REGISTRATION KEYS

Key	Tag	Type	Attribute Description
Specific Character Set	(0008,0005)	1C	FSC copies this value from the first instance of the series. FSR supports all character sets.
Content Date	(0008,0023)	1	
Content Time	(0008,0033)	1	
Instance Number	(0020,0013)	1	
Content Label	(0070,0080)	1	
Content Description	(0070,0081)	2	
Content Creator's Name	(0070,0084)	2	

5.2.3.12 Encapsulated Document Directory Record Definition

TABLE 5-20 ENCAPSULATED DOCUMENT KEYS

Key	Tag	Type	Attribute Description
Specific Character Set	(0008,0005)	1C	FSC copies this value from the first instance of the series. FSR supports all character sets.
Content Date	(0008,0023)	1	
Content Time	(0008,0033)	1	
Instance Number	(0020,0013)	1	An image without instance number cannot be written on the media.
Document Title	(0042,0010)	2	
HL7 Instance Identifier	(0040,E001)	1C	
Concept Name Code Sequence	(0040,A043)	2	
<i>>Include 'Code Sequence Macro'</i>			
MIME Type of Encapsulated Document	(0042,0012)	1	

6. PRINT MANAGEMENT IMPLEMENTATION

6.1 INTRODUCTION

This section of the DICOM Conformance Statement specifies the supported Print Management SOP and Meta SOP Classes, the optional attributes and service elements supported, the valid range of values for mandatory and optional attributes, and the status code behavior.

This section contains:

6.2.1- Basic Film Session SOP Class

6.2.2 - Basic Film Box SOP Class

6.2.3 - Image Box SOP Classes

6.2.4 - Printer SOP Class

6.2 PRINT MANAGEMENT SOP CLASS DEFINITIONS

6.2.1 Basic Film Session SOP Class

The DICOM Print SCU AE supports the N-CREATE DIMSE Service Element for the Basic Film Session SOP Class.

- The N-CREATE DIMSE Service element sent by the DICOM Print SCU AE requests the Remote DICOM Print SCP to create an instance of Basic Film Session.

6.2.1.1 IOD Description

6.2.1.1.1 IOD modules

Module	Reference	Module Description
SOP Common	6.2.1.1.2	Contains SOP Common information
Basic Film Session Presentation Module	6.2.1.1.3	Contains Film Session presentations information
Basic Film Session Relationship	6.2.1.1.4	References to related SOPs

6.2.1.1.2 SOP Common Module

Attribute Name	Tag	Type	Attribute Description
SOP Class UID	(0008,0016)	1	1.2.840.10008.5.1.1.1
SOP Instance UID	(0008,0018)	1	Generated from GE Based UID: <station configuration> and timestamp

GE Healthcare

DIR 5479848-1EN REV 1

6.2.1.1.3 Basic Film Session Presentation Module

Attribute name	Tag	Attribute Description
Number of Copies	(2000,0010)	1 to 10, depending of print manager configuration. Default value: 1
Print Priority	(2000,0020)	HIGH or MED or LOW depending of default configuration Default value: LOW
Medium Type	(2000,0030)	PAPER or CLEAR FILM or BLUE FILM depending of configuration of associated Remote DICOM printer Default value: BLUE FILM
Film Destination	(2000,0040)	MAGAZINE or PROCESSOR depending of configuration of associated Remote DICOM printer Default value:PROCESSOR
Film Session Label	(2000,0050)	Configurable by the Field Engineer Not sent by default

Note: Default configuration can be modified during the installation of the Advantage Workstation 4.7.

6.2.1.1.4 Basic Film Session Relationship Module

Attribute Name	Tag	Attribute Description
Referenced Film Box Sequence	(2000,0500)	Not used
>Referenced SOP Class UID	(0008,1150)	Not used
>Referenced SOP Instance UID	(0008,1155)	Not used

6.2.1.2 DIMSE Service Group

DIMSE Service Element	Usage SCU
N-CREATE	M
N-SET	Not used
N-DELETE	Not used
N-ACTION	Not used

6.2.1.2.1 N-CREATE

6.2.1.2.1.1 Attributes

Attribute Name	Tag	Usage SCU
Number of Copies	(2000,0010)	Used
Print Priority	(2000,0020)	Used
Medium Type	(2000,0030)	Used
Film Destination	(2000,0040)	Used
Film Session Label	(2000,0050)	Used, not sent if empty

Memory Allocation	(2000,0060)	Not Used
-------------------	-------------	----------

6.2.1.2.1.2 Status

Service Status	Status Codes	Further Meaning	Application Behavior When receiving Status Codes
Warning	B600	Memory allocation not supported	Association is aborted
Success	0000	Film session successfully created	Next step describe in the sequencing of Real-World Activities paragraph is performed

Note: The association is aborted for all other status.

6.2.1.2.1.3 Behavior

No specific behavior

6.2.1.2.2 N-SET

This service is not used.

6.2.1.2.3 N-DELETE

This service is not used.

6.2.1.2.4 N-ACTION

This service is not used.

6.2.2 Basic Film Box SOP Class

The DICOM Print SCU AE supports the following DIMSE Service Element for the Basic Film Box SOP Class.

- The N-CREATE DIMSE Service element sent by the DICOM Print SCU AE requests the Remote DICOM Print SCP to create an instance of Basic Film Box
- The N-ACTION DIMSE Service element sent by the DICOM Print SCU AE requests the Remote DICOM Print SCP to print the Basic Film Box onto the hard copy printer.
- The N-DELETE DIMSE Service element sent by the DICOM Print SCU AE requests the Remote DICOM Print SCP to release the Basic Film Box instance.

GE Healthcare

DIR 5479848-1EN REV 1

6.2.2.1 IOD Description

6.2.2.1.1 IOD modules

Module	Reference	Module Description
SOP Common	6.2.2.1.2	Contains SOP Common information
Basic Film Box Presentation Module	6.2.2.1.3	Contains Film Box presentation information
Basic Film Box Relationship Module	6.2.2.1.4	References to related SOPs

GE Healthcare

DIR 5479848-1EN REV 1

6.2.2.1.2 SOP Common Module

Attribute Name	Tag	Type	Attribute Description
SOP Class UID	(0008,0016)	1	1.2.840.10008.5.1.1.2
SOP Instance UID	(0008,0018)	1	Generated from GE Based UID: <station configuration> and timestamp

6.2.2.1.3 Basic Film Box Presentation Module

Attribute Name	Tag	Attribute Description
Image Display Format	(2010,0010)	STANDARD\C,R [C 1 to 5] and [R 1 to 4] SLIDE SUPERSLIDE Default value: STANDARD (Depending of configuration of associated remote DICOM printer).
Annotation Display Format ID	(2010,0030)	Not sent.
Film Orientation	(2010,0040)	PORTRAIT LANDSCAPE Default value: PORTRAIT (Depending of configuration of associated remote DICOM printer).
Film Size ID	(2010,0050)	8INX10IN 8_5INX11IN(Letter) 10INX12IN 10INX14IN 11INX14IN 11INX17IN 14INX14IN 14INX17IN 24CMX24CM 24CMX30CM A4(210mmx297mm) A3(297mm x 420mm) (Depending of configuration of associated remote DICOM printer). Default value: First selection when declaring printer.
Magnification Type	(2010,0060)	One of the following defined term is sent: REPLICATE BILINEAR CUBIC NONE Default value: CUBIC (Depending of configuration set by user when declaring the printer).
Smoothing Type	(2010,0080)	Sent if Magnification type = CUBIC Default value: "" (Depending of configuration set by user when declaring the printer).
Border density	(2010,0100)	BLACK or WHITE depending of default configuration. Default value: BLACK

Empty Image Density	(2010,0110)	BLACK or WHITE depending of default configuration. Default value: ""
Min Density	(2010,0120)	-1 by default or set to positive integer. Default value depends of configuration set by user when declaring the printer
Max Density	(2010,0130)	-1 by default or set to positive integer. Default value depends of configuration set by user when declaring the printer
Trim	(2010,0140)	Set to YES or NO according to value set by user when declaring the printer. Default value: NO
Configuration Information	(2010,0150)	Empty by default or set to a value defined when declaring the printer.
Illumination	(2010,015E)	Not sent.
Reflected Ambient Light	(2010,0160)	Not sent.
Requested Resolution ID	(2020,0050)	Not sent.
Referenced Presentation LUT Sequence	(2050,0500)	Not sent.

6.2.2.1.4 Basic Film Box Relationship Module

Attribute Name	Tag	Attribute Description
Referenced Film Session Sequence	(2010,0500)	Used (Set)
>Referenced SOP Class UID	(0008,1150)	1.2.840.10008.5.1.1.1
>Referenced SOP Instance UID	(0008,1155)	Used (Set to the Film Session SOP Instance UID)
Referenced Image Box Sequence	(2010,0510)	Used, when received
>Referenced SOP Class UID	(0008,1150)	Used, when received
>Referenced SOP Instance UID	(0008,1155)	Used, when received
Referenced Basic Annotation Box Sequence	(2010,0520)	Not used
>Referenced SOP Class UID	(0008,1150)	Not used
>Referenced SOP Instance UID	(0008,1155)	Not used

6.2.2.2 DIMSE Service Group

DIMSE Service Element	Usage SCU
N-CREATE	M
N-ACTION	M
N-DELETE	Used

GE Healthcare

DIR 5479848-1EN REV 1

6.2.2.2.1 N-CREATE

6.2.2.2.1.1 Attributes

Attribute Name	Tag	Usage SCU
Image Display Format	(2010,0010)	M
Referenced Film Session Sequence	(2010,0500)	M
>Referenced SOP Class UID	(0008,1150)	M
>Referenced SOP Instance UID	(0008,1155)	M
Referenced Image Box Sequence	(2010,0510)	Used (Received)
>Referenced SOP Class UID	(0008,1150)	Used (Received)
>Referenced SOP Instance UID	(0008,1155)	Used (Received)
Referenced Basic Annotation Box Sequence	(2010,0520)	Not used
>Referenced SOP Class UID	(0008,1150)	Not used
>Referenced SOP Instance UID	(0008,1155)	Not used
Film Orientation	(2010,0040)	Used
Film Size ID	(2010,0050)	Used
Magnification Type	(2010,0060)	Used
Max Density	(2010,0130)	Used. Not sent if -1
Configuration Information	(2010,0150)	Used. Not sent if empty
Annotation Display Format ID	(2010,0030)	Not used
Smoothing Type	(2010,0080)	Used. Not sent if magnification different from CUBIC
Border Density	(2010,0100)	Used Not sent if empty
Empty Image Density	(2010,0110)	Used Not sent if empty
Min Density	(2010,0120)	Used Not sent if -1
Trim	(2010,0140)	Used Not sent if empty

6.2.2.2.1.2 Status

Service Status	Status Codes	Further Meaning	Application Behavior When receiving Status Codes
Success	0000	Film Box successfully created	Association goes on
Warning	B605	Requested Min Density or Max Density outside of printer's operating range. The printer will use its respective minimum or maximum density value instead.	Treated as Success
Failure	C616	There is an existing Film Box that has not been printed and N-ACTION at the Film Session level is not supported. A new Film Box will not be created when a previous Film Box has not been printed.	Association is aborted

The association is aborted for all other status.

GE Healthcare

DIR 5479848-1EN REV 1

6.2.2.2.1.3 Behavior

There is no specific behavior.

6.2.2.2.2 N-DELETE

6.2.2.2.2.1 Behavior

The SCU uses the N-DELETE to request the SCP to delete the Basic Film Box SOP Instance hierarchy.

6.2.2.2.2.2 Status

Service Status	Status Codes	Further Meaning	Application Behavior When receiving Status Codes
Failure	0119	Class-instance conflict	Association aborted
	0210	Duplicate invocation	Association aborted
	0117	Invalid SOP instance	Association aborted
	0212	Mistyped argument	Association aborted
	0118	No such SOP Class	Association aborted
	0112	No such SOP Instance	Association aborted
	0110	Processing failure	Association aborted
	0213	Resource limitation	Association aborted
	0211	Unrecognized operation	Association aborted
Success	0000	Film session successfully deleted	Job successfully canceled
*	*	Any other status code.	Ignored

6.2.2.2.3 N-ACTION

N-ACTION is used to print the current film of the film session.

6.2.2.2.3.1 Attributes

Action Type Name	Action Type ID	Attribute	Tag	Usage SCU
Print	1	Referenced Print Job Sequence	(2100,0500)	Not used
		>Referenced SOP Class UID	(0008,1150)	Not used

		>Referenced SOP Instance UID	(0008,1155)	Not used
--	--	------------------------------	-------------	----------

6.2.2.2.3.2 Status

Service Status	Status Codes	Further Meaning	Application Behavior When receiving Status Codes
Success	0000	Film accepted for printing.	Next step describe in the sequencing of Real-World Activities paragraph is performed
Warning	B603	Film Box SOP Instance hierarchy does not contain Image Box SOP Instances (empty page)	This case should not happen. This warning is considered as an error. Association is aborted.
	B604	Image size is larger than image box size.	This case should not happen. This warning is considered as an error. Association is aborted.
	B609	Image size is larger than the Image Box size. The Image has been cropped to fit.	This case should not happen. This warning is considered as an error. Association is aborted.
	B60A	Image size or Combined Print Image size is larger than the Image Box size. Image or Combined Print Image has been decimated to fit.	This case should not happen. This warning is considered as an error. Association is aborted.
Failure	C602	Unable to create Print Job SOP Instance; print queue is full	Appropriate message is returned to the user. Association is aborted.
	C604	Image position collision: multiple images assigned to single image position	Appropriate message is returned to the user. Association is aborted.
	C603	Image size is larger than image box size (by using the specified magnification value)	Appropriate message is returned to the user. Association is aborted.
	C613	Combined Print Image size is larger than the Image Box size	Appropriate message is returned to the user. Association is aborted.

6.2.2.2.3.3 Behavior

SCU uses the N-ACTION to request the SCP to print one or more copies of a single film of the film session.

6.2.3 Image Box SOP Classes

6.2.3.1 Basic Grayscale Image Box SOP Class

The DICOM Print SCU AE supports the following DIMSE Service Element for the Basic Grayscale Image Box SOP Class.

- The N-SET DIMSE Service element sent by the DICOM Print SCU AE requests the Remote DICOM Print SCP to set the attributes of the Basic Grayscale Image Box Instance.

GE Healthcare

DIR 5479848-1EN REV 1

6.2.3.1.1 IOD description

6.2.3.1.1.1 IOD modules

Module	Reference	Module Description
SOP Common	6.2.3.1.1.2	Contains SOP Common information
Image Box Pixel Presentation Module	6.2.3.1.1.3	Contains Image Box presentation information
Image Box Relationship Module	6.2.3.1.1.4	References to related SOPs

6.2.3.1.1.2 SOP Common Module

Attribute Name	Tag	Type	Attribute Description
SOP Class UID	(0008,0016)	1	1.2.840.10008.5.1.1.4
SOP Instance UID	(0008,0018)	1	Generated from GE Based UID: <station configuration> and timestamp

6.2.3.1.1.3 Image Box Pixel Presentation Module

Attribute Name	Tag	Attribute Description
Image Position	(2020,0010)	Value depends of the position within the Film box (1-N)
Polarity	(2020,0020)	NORMAL = pixels shall be printed as specified by the Photometric Interpretation (0028,0004) REVERSE = pixels shall be printed with the opposite polarity as specified by the Photometric Interpretation (0028,0004) Default value: NORMAL (Depending of default configuration)
Magnification Type	(2010,0060)	Same value as defined in the Film box
Smoothing Type	(2010,0080)	Same value as defined in the Film box
Configuration Information	(2010,0150)	Same value as defined in the Film Box.

Requested Image Size	(2020,0030)	Not sent
Requested Decimate/Crop Behavior	(2020,0040)	Not sent
Basic Grayscale Image Sequence	(2020,0110)	This sequence is always included if the Image Box is a Basic Grayscale Image Box
>Samples Per Pixel	(0028,0002)	1
>Photometric Interpretation	(0028,0004)	MONOCHROME1 or MONOCHROME2 depending of default configuration. Default value: MONOCHROME2
>Rows	(0028,0010)	Original image height
>Columns	(0028,0011)	Original image width
>Pixel Aspect Ratio	(0028,0034)	1\1
>Bits Allocated	(0028,0100)	Depends on the image pixel depth (8 or 16)
>Bits Stored	(0028,0101)	Depends on the image pixel depth (8, 12 bits)
>High Bit	(0028,0102)	Depends on the image pixel depth (7, 11)
>Pixel Representation	(0028,0103)	0 (Unsigned Integer)
>Pixel Data	(7FE0,0010)	
Original Image Sequence	(2130,00C0)	Not sent

6.2.3.1.1.4 Image Box Relationship Module

Attribute Name	Tag	Attribute Description
Referenced Image Sequence	(0008,1140)	Not used
>Referenced SOP Class UID	(0008,1150)	Not used
>Referenced SOP Instance UID	(0008,1155)	Not used
>Referenced Frame Number	(0008,1160)	Not used
Referenced Image Overlay Box Sequence	(2020,0130)	Not used
>Referenced SOP Class UID	(0008,1150)	Not used
>Referenced SOP Instance UID	(0008,1155)	Not used
>Referenced Frame Number	(0008,1160)	Not used
Referenced VOI LUT Sequence	(2020,0140)	Not used
>Referenced SOP Class UID	(0008,1150)	Not used
>Referenced SOP Instance UID	(0008,1155)	Not used

6.2.3.1.2 DIMSE Service Group

DIMSE Service Element	Usage SCU
N-SET	M

GE Healthcare

DIR 5479848-1EN REV 1

6.2.3.1.2.1 N-SET

6.2.3.1.2.1.1 Attributes

Attribute Name	Tag	Usage SCU
Image Position	(2020,0010)	M
Basic Grayscale Image Sequence	(2020,0110)	M
>Samples Per Pixel	(0028,0002)	M
>Photometric Interpretation	(0028,0004)	M
>Rows	(0028,0010)	M
>Columns	(0028,0011)	M
>Pixel Aspect Ratio	(0028,0034)	M
>Bits Allocated	(0028,0100)	M
>Bits Stored	(0028,0101)	M
>High Bit	(0028,0102)	M
>Pixel Representation	(0028,0103)	M
>Pixel Data	(7FE0,0010)	M
Polarity	(2020,0020)	Used
Referenced Overlay Sequence	(0008,1130)	Not used
>SOP Class UID	(0008,1150)	Not used
>SOP Instance UID	(0008,1155)	Not used
Magnification Type	(2010,0060)	Used
Smoothing Type	(2010,0080)	Used, not sent if magnification is different of CUBIC
Configuration Information	(2010,0150)	Used, not sent if empty
Requested Image Size	(2020,0030)	Not used

6.2.3.1.2.1.2 Status

Service Status	Status Codes	Further Meaning	Application Behavior When receiving Status Codes
Failure	C603	Image size is larger than image box size	Appropriate message is returned to the user. Association is aborted.
	C605	Insufficient memory in printer to store the image	Appropriate message is returned to the user. Association is aborted.
	C613	Combined Print Image size is larger than the Image Box size	Appropriate message is returned to the user. Association is aborted.
	0119	Class-instance conflict	Generic error message is returned to the user. Association is aborted.
	0210	Duplicate invocation	Generic error message is returned to the user. Association is aborted.
	0106	Invalid attribute value	Generic error message is returned to the user. Association is aborted.
	0212	Mistyped argument	Generic error message is returned to the user. Association is aborted.

	0117	Invalid SOP instance	Generic error message is returned to the user. Association is aborted.
	0121	Missing attribute value	Generic error message is returned to the user. Association is aborted.
	0105	No such attributes	Generic error message is returned to the user. Association is aborted.
	0118	No such SOP Class	Generic error message is returned to the user. Association is aborted.
	0112	No such SOP Instance	Generic error message is returned to the user. Association is aborted.
	0110	Processing failure	Generic error message is returned to the user. Association is aborted.
	0213	Resource limitation	Generic error message is returned to the user. Association is aborted.
	0211	Unrecognized operation	Generic error message is returned to the user. Association is aborted.
Warning	B604	Image size larger than image box size, the image has been demagnified.	Following printing choice (true size), the warning can be ignored (Association goes on) or considered as a failure (Association is aborted)
	B605	Requested Min Density or Max Density outside of printer's operating range. The printer will use its respective minimum or maximum density value instead.	Considered as Success
	B609	Image size is larger than the Image Box size. The Image has been cropped to fit.	Following printing choice (true size), the warning can be ignored (Association goes on) or considered as a failure (Association is aborted)
	B60A	Image size or Combined Print Image size is larger than the Image Box size. The Image or Combined Print Image has been decimated to fit.	Following printing choice (true size), the warning can be ignored (Association goes on) or considered as a failure (Association is aborted)
Success	0000	Image successfully stored in Image Box	Association goes on
*	*	Any other status code.	Ignored

6.2.3.1.2.1.3 Behavior

There is no specific behavior.

6.2.3.2 Basic Color Image Box SOP Class

The DICOM Print SCU AE supports the following DIMSE Service Element for the Color Image Box SOP Class.

- The N-SET DIMSE Service element sent by the DICOM Print SCU AE requests the Remote DICOM Print SCP to set the attributes of the Color Image Box Instance.

GE Healthcare

DIR 5479848-1EN REV 1

6.2.3.2.1 IOD description

6.2.3.2.1.1 IOD modules

Module	Reference	Module Description
SOP Common	6.2.3.2.1.2	Contains SOP Common information
Image Box Pixel Presentation Module	6.2.3.2.1.3	Contains Image Box presentation information
Image Box Relationship Module	6.2.3.2.1.4	References to related SOPs

6.2.3.2.1.2 SOP Common Module

Attribute Name	Tag	Type	Attribute Description
SOP Class UID	(0008,0016)	1	1.2.840.10008.5.1.1.4.1
SOP Instance UID	(0008,0018)	1	Generated from GE Based UID: <station configuration> and timestamp

6.2.3.2.1.3 Image Box Pixel Presentation Module

Attribute Name	Tag	Attribute Description
Image Position	(2020,0010)	Value depends of the position within the Film box (1-N)
Polarity	(2020,0020)	NORMAL
Magnification Type	(2010,0060)	Same value as defined in the Film box
Smoothing Type	(2010,0080)	Same value as defined in the Film box
Configuration Information	(2010,0150)	Same value as defined in the Film Box.
Requested Image Size	(2020,0030)	Not sent
Requested Decimate/Crop Behavior	(2020,0040)	Not sent
Basic Color Image Sequence	(2020,0111)	This sequence is always included if the Image Box is a Basic Color Image Box
>Samples Per Pixel	(0028,0002)	3
>Photometric Interpretation	(0028,0004)	RGB
>Planar Configuration	(0028,0006)	1
>Rows	(0028,0010)	Original image height
>Columns	(0028,0011)	Original image width
>Pixel Aspect Ratio	(0028,0034)	1\1
>Bits Allocated	(0028,0100)	8
>Bits Stored	(0028,0101)	8
>High Bit	(0028,0102)	7
>Pixel Representation	(0028,0103)	0
>Pixel Data	(7FE0,0010)	
Original Image Sequence	(2130,00C0)	Not sent

GE Healthcare

DIR 5479848-1EN REV 1

6.2.3.2.1.4 Image Box Relationship Module

Attribute Name	Tag	Attribute Description
Referenced Image Sequence	(0008,1140)	Not used
>Referenced SOP Class UID	(0008,1150)	Not used
>Referenced SOP Instance UID	(0008,1155)	Not used
>Referenced Frame Number	(0008,1160)	Not used
Referenced Image Overlay Box Sequence	(2020,0130)	Not used
>Referenced SOP Class UID	(0008,1150)	Not used
>Referenced SOP Instance UID	(0008,1155)	Not used
>Referenced Frame Number	(0008,1160)	Not used
Referenced VOI LUT Sequence	(2020,0140)	Not used
>Referenced SOP Class UID	(0008,1150)	Not used
>Referenced SOP Instance UID	(0008,1155)	Not used

6.2.3.2.2 DIMSE Service Group

DIMSE Service Element	Usage SCU
N-SET	M

GE Healthcare

DIR 5479848-1EN REV 1

6.2.3.2.2.1 N-SET

6.2.3.2.2.1.1 Attributes

Attribute Name	Tag	Usage SCU
Image Position	(2020,0010)	M
Basic Color Image Sequence	(2020,0111)	M
>Samples Per Pixel	(0028,0002)	M
>Photometric Interpretation	(0028,0004)	M
>Planar Configuration	(0028,0006)	Used
>Rows	(0028,0010)	M
>Columns	(0028,0011)	M
>Pixel Aspect Ratio	(0028,0034)	M
>Bits Allocated	(0028,0100)	M
>Bits Stored	(0028,0101)	M
>High Bit	(0028,0102)	M
>Pixel Representation	(0028,0103)	M
>Pixel Data	(7FE0,0010)	M
Polarity	(2020,0020)	Used
Referenced Overlay Sequence	(0008,1130)	Not used
>SOP Class UID	(0008,1150)	Not used
>SOP Instance UID	(0008,1155)	Not used
Magnification Type	(2010,0060)	Used
Smoothing Type	(2010,0080)	Used. Not sent if magnification is different of CUBIC
Configuration Information	(2010,0150)	Used, not sent if empty
Requested Image Size	(2020,0030)	Not used

6.2.3.2.2.1.2 Status

Service Status	Status Codes	Further Meaning	Application Behavior When receiving Status Codes
Failure	C603	Image size is larger than image box size	Appropriate message is returned to the user. Association is aborted.
	C605	Insufficient memory in printer to store the image	Appropriate message is returned to the user. Association is aborted.
	C613	Combined Print Image size is larger than the Image Box size	Appropriate message is returned to the user. Association is aborted.
	0119	Class-instance conflict	Generic error message is returned to the user. Association is aborted.
	0210	Duplicate invocation	Generic error message is returned to the user. Association is aborted.
	0106	Invalid attribute value	Generic error message is returned to the user. Association is aborted.

	0212	Mistyped argument	Generic error message is returned to the user. Association is aborted.
	0117	Invalid SOP instance	Generic error message is returned to the user. Association is aborted.
	0121	Missing attribute value	Generic error message is returned to the user. Association is aborted.
	0105	No such attributes	Generic error message is returned to the user. Association is aborted.
	0118	No such SOP Class	Generic error message is returned to the user. Association is aborted.
	0112	No such SOP Instance	Generic error message is returned to the user. Association is aborted.
	0110	Processing failure	Generic error message is returned to the user. Association is aborted.
	0213	Resource limitation	Generic error message is returned to the user. Association is aborted.
	0211	Unrecognized operation	Generic error message is returned to the user. Association is aborted.
Warning	B604	Image size larger than image box size, the image has been demagnified.	Following printing choice (true size), the warning can be ignored (Association goes on) or considered as a failure (Association is aborted)
	B605	Requested Min Density or Max Density outside of printer's operating range. The printer will use its respective minimum or maximum density value instead.	Considered as Success
	B609	Image size is larger than the Image Box size. The Image has been cropped to fit.	Following printing choice (true size), the warning can be ignored (Association goes on) or considered as a failure (Association is aborted)
	B60A	Image size or Combined Print Image size is larger than the Image Box size. The Image or Combined Print Image has been decimated to fit.	Following printing choice (true size), the warning can be ignored (Association goes on) or considered as a failure (Association is aborted)
Success	0000	Image successfully stored in Image Box	Association goes on
*	*	Any other status code.	Ignored

6.2.3.2.2.1.3 Behavior

There is no specific behavior.

6.2.4 Printer SOP Class

The DICOM Print SCU AE supports the following DIMSE Service Element for the Basic Printer SOP Class.

The N-EVENT_REPORT DIMSE Service element sent by the DICOM Print SCP to the local DICOM Print SCU AE. The DICOM Print SCU handles the Printer Status and Printer Status Info fields. All other received data are ignored.

The N-GET DIMSE Service element sent by the DICOM Print SCU AE requests the Remote DICOM Print SCP to give information on the Remote DICOM Printer.

6.2.4.1 IOD Description

6.2.4.1.1 IOD modules

Module	Reference	Module Description
SOP Common	6.2.4.1.2	Contains SOP Common information
Printer Module	6.2.4.1.3	Contains status information to monitor the printer

6.2.4.1.2 SOP Common Module

Attribute Name	Tag	Type	Attribute Description
SOP Class UID	(0008,0016)	1	1.2.840.10008.5.1.1.16
SOP Instance UID	(0008,0018)	1	Generated from GE Based UID: <station configuration> and timestamp

6.2.4.1.3 Printer Module

Attribute Name	Tag	Attribute Description
Printer Status	(2110,0010)	The behaviour defined for the following term <ul style="list-style-type: none"> • NORMAL: Association goes on. • FAILURE: Association is aborted. • WARNING: Association is not released
Printer Status Info	(2110,0020)	Printer return value
Printer Name	(2110,0030)	Printer return value
Manufacturer	(0008,0070)	Printer return value if not empty
Manufacturer Model Name	(0008,1090)	Printer return value if not empty
Device Serial Number	(0018,1000)	Printer return value if not empty
Software Versions	(0018,1020)	Printer return value if not empty
Date Of Last Calibration	(0018,1200)	Printer return value if not empty
Time Of Last Calibration	(0018,1201)	Printer return value if not empty

6.2.4.2 DIMSE Service Group

DIMSE Service Element	Usage SCU
N-EVENT-REPORT	M
N-GET	U

GE Healthcare

DIR 5479848-1EN REV 1

6.2.4.2.1 N-EVENT-REPORT

6.2.4.2.1.1 Attributes

Event Type Name	Event Type ID	Attribute	Tag	Usage SCU
Normal	1	Printer Name	(2110,0030)	Used
		Printer Status Info	(2110,0020)	Used
Warning	2	Printer Name	(2110,0030)	Used
		Printer Status Info	(2110,0020)	Used
Failure	3	Printer Name	(2110,0030)	Used
		Printer Status Info	(2110,0020)	Used

6.2.4.2.1.2 Behavior

On reception Failure status, the Print SCU aborts the association.

If Event Report Type ID is FAILURE

Signal print failure to the user, association is aborted

Else If Event Report Type ID is WARNING

Signal print warning to the user

Else

Signal print success to the user

In all cases, N-EVENT-REPORT_RSP with the status of Success is returned

6.2.4.2.2 N-GET

6.2.4.2.2.1 Attributes

Attribute name	Tag	Usage SCU
Printer Status	(2110,0010)	Used
Printer Status Info	(2110,0020)	Used
Printer Name	(2110,0030)	Used if returned by the printer
Manufacturer	(0008,0070)	Used if returned by the printer
Manufacturer Model Name	(0008,1090)	Used if returned by the printer
Device Serial Number	(0018,1000)	Used if returned by the printer
Software Versions	(0018,1020)	Used if returned by the printer
Date Last Calibration	(0018,1200)	Used if returned by the printer
Last Calibration	(0018,1201)	Used if returned by the printer

6.2.4.2.2.2 Behavior

If Printer Status is FAILURE

Signal print failure to the user, association aborted

Else If Printer Status is WARNING

Signal print warning to the user

Else

Signal print success to the user

In case of FAILURE or WARNING, the Printer Status Info is displayed to user under a readable message

7. SECONDARY CAPTURE INFORMATION OBJECT IMPLEMENTATION

7.1 INTRODUCTION

This section specifies the use of the DICOM SC Image IOD to represent the information included in SC images produced by this implementation. Corresponding attributes are conveyed using the module construct. The contents of this section are:

In the Viewer workflow, each secondary capture DICOM field (Screen Save image) will be filled with value present in the original image, except when a specific rule is applied and described in this chapter.

In the AngioViz workflow, each secondary capture DICOM field (Screen Save image) will be filled just like Viewer workflow, except when a specific rule is applied and described in this chapter.

7.2- SC Entity-Relationship Model

7.3- SC-IOD MODULE TABLE

7.4- SC-INFORMATION MODULE DEFINITIONS

7.5- SC-PRIVATE data dictionary

In the following chapter, all new study, series and image instance UID are generated from base UID:

- for AW4.7 2D Multi-Modality Viewer: **1.2.840.113619.2.378**
- for AW 4.7 Filmer: **1.2.840.113619.2.377**

Note: Note: A Screen Save image is a DICOM Secondary Capture generated by Advantage Workstation 4.7.

7.2 SC ENTITY-RELATIONSHIP MODEL

The Entity-Relationship diagram for the SC Image interoperability schema is shown in **Illustration 8.2.1**. In this figure, the following diagrammatic convention is established to represent the information organization:

- Each entity is represented by a rectangular box
- Each relationship is represented by a diamond shaped box.
- The fact that a relationship exists between two entities is depicted by lines connecting the corresponding entity boxes to the relationship boxes.

The relationships are fully defined with the maximum number of possible entities in the relationship shown. In other words, the relationship between Series and Image can have up to n Images per Series, but the Patient to Study relationship has 1 Study for each Patient (a Patient can have more than one Study on the system, however each Study will contain all of the information pertaining to that Patient).

ILLUSTRATION 7.2-1
 SC IMAGE ENTITY RELATIONSHIP DIAGRAM

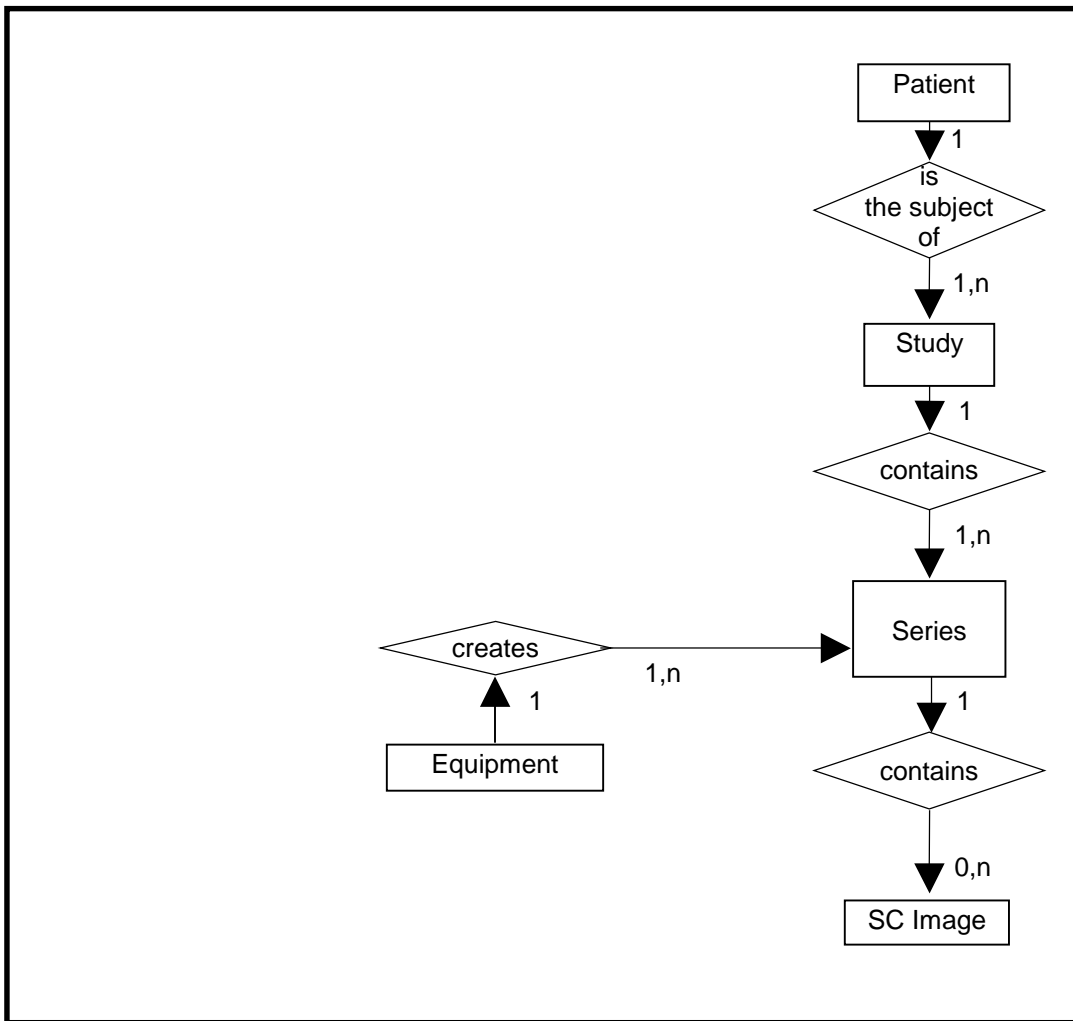

7.2.1 ENTITY DESCRIPTIONS

Please refer to DICOM Standard Part 3 (Information Object Definitions) for a description of each of the entities contained within the SC Information Object.

7.2.2 Advantage Workstation 4.7 Mapping of DICOM entities

TABLE 7-1 MAPPING OF DICOM ENTITIES TO ADVANTAGE WORKSTATION 4.7 ENTITIES

DICOM	Advantage Workstation 4.7 Entity
Patient	Patient
Study	Exam
Series	Series
Image	Image

7.3 SC-IOD MODULE TABLE

Within an entity of the DICOM SC IOD, attributes are grouped into related set of attributes. A set of related attributes is termed a module. A module facilitates the understanding of the semantics concerning the attributes and how the attributes are related with each other. A module grouping does not infer any encoding of information into datasets.

Table 6.3-1 identifies the defined modules within the entities that comprise the DICOM SC IOD. The modules are identified by their Module Name.

See DICOM Part 3 for a complete definition of the entities, modules, and attributes.

TABLE 7-2 SC IMAGE IOD MODULES

Entity Name	Module Name	Usage	Reference
Patient	Patient	Used	7.4.1.1
	Clinical Trial Subject	Not used	N/A
Study	General Study	Used	7.4.2.1
	Patient Study	Used	7.4.2.2
	Clinical Trial Study	Not used	N/A
Series	General Series	Used	7.4.3.1
	Clinical Trial Series	Not used	N/A
Equipment	General Equipment	Used	7.4.4.1
	SC Equipment	Used	7.4.9.1
Image	General Image	Used	7.4.5.1
	Image Pixel	Used	7.4.5.2
	Device	Not used	N/A
	SC Image	Used	7.4.9.2
	Overlay Plane	Not used	N/A
	Modality LUT	Used	7.4.7.2
	VOI LUT	Used	7.4.7.1
	SOP Common	Used	7.4.8.1

7.4 SC-INFORMATION MODULE DEFINITIONS

Please refer to DICOM Standard Part 3 (Information Object Definitions) for a description of each of the entities and modules contained within the SC Information Object.

The following modules are included to convey Enumerated Values, Defined Terms, and Optional Attributes supported. Type 1 & Type 2 Attributes are also included for completeness and to define what values they may take and where these values are obtained from. It should be noted that they are the same ones as defined in the DICOM Standard Part 3 (Information Object Definitions).

Note: Elements not listed are not supported

7.4.1 Common Patient Entity Modules

7.4.1.1 Patient Module

This section specifies the Attributes of the Patient that describe and identify the Patient who is the subject of a diagnostic Study. This Module contains Attributes of the patient that are needed for diagnostic interpretation of the Image and are common for all studies performed on the patient.

TABLE 7-3 PATIENT MODULE ATTRIBUTES

Attribute Name	Tag	Type	Attribute Description
Patient's Name	(0010,0010)	2	<u>Viewer/AngioViz</u> Original <u>Filmer</u> Original if No Mix Mode or Mix Mode = Study User defined if Mix Mode = Patient
Patient ID	(0010,0020)	2	<u>Viewer/AngioViz</u> Original <u>Filmer</u> Original if No Mix Mode or Mix Mode = Study Function of pid and time if Mix Mode = Patient
Issuer of Patient ID	(0010,0021)	3	Not Present
Issuer of Patient ID Qualifiers Sequence	(0010,0024)	3	Not Present
Patient's Birth Date	(0010,0030)	2	<u>Viewer/AngioViz</u> Original <u>Filmer</u> Original if No Mix Mode or Mix Mode = Study Empty if Mix Mode = Patient
Patient's Sex	(0010,0040)	2	<u>Viewer/AngioViz</u> Original <u>Filmer</u> Original if No Mix Mode or Mix Mode = Study Empty if Mix Mode = Patient
Other Patient ID	(0010,1000)	3	Not Present
Other Patient Ids Sequence	(0010,1002)	3	Not Present

7.4.2 Common Study Entity Modules

7.4.2.1 General Study Module

This section specifies the Attributes, which describe and identify the Study performed upon the Patient.

TABLE 7-4 GENERAL STUDY MODULE ATTRIBUTES

Attribute Name	Tag	Type	Notes
Study Instance UID	(0020,000D)	1	<u>Viewer/AngioViz</u> Original <u>Filmer</u> Original if No Mix Mode Generated if Mix Mode = Patient or Mix Mode = Study
Study Date	(0008,0020)	2	<u>Viewer/AngioViz</u> Original (Empty if does not exist) <u>Filmer</u> Original (Empty if does not exist) if No Mix Mode Empty if Mix Mode = Patient or Mix Mode = Study
Study Time	(0008,0030)	2	<u>Viewer/AngioViz</u> Original (Empty if does not exist) <u>Filmer</u> Original (Empty if does not exist) if No Mix Mode Empty if Mix Mode = Patient or Mix Mode = Study
Referring Physician's Name	(0008,0090)	2	<u>Viewer/AngioViz</u> Original (Empty if does not exist) <u>Filmer</u> Original (Empty if does not exist) if No Mix Mode Empty if Mix Mode = Patient or Mix Mode = Study
Study ID	(0020,0010)	2	<u>Viewer/AngioViz</u> Original (Empty if does not exist) <u>Filmer</u> Original (Empty if does not exist) if No Mix Mode Generated if Mix Mode = Patient or Mix Mode = Study

Accession Number	(0008,0050)	2	<u>Viewer/AngioViz</u> Original (Empty if does not exist) <u>Filmer</u> Original (Empty if does not exist) if No Mix Mode Empty if Mix Mode = Patient or Mix Mode = Study
Study Description	(0008,1030)	3	<u>Viewer/AngioViz</u> Original (Empty if does not exist) <u>Filmer</u> Original (Empty if does not exist) if No Mix Mode User defined if Mix Mode = Patient or Mix Mode = Study

7.4.2.2 Patient Study Module

This section defines Attributes that provide information about the Patient at the time the Study was performed.

TABLE 7-5 PATIENT STUDY MODULE ATTRIBUTES

Attribute Name	Tag	Type	Attribute Description
Patient's Age	(0010,1010)	3	<u>Viewer/AngioViz</u> Original <u>Filmer</u> Original if No Mix Mode Not present if Mix Mode = Patient or Mix Mode = Study
Patient's Size	(0010,1020)	3	<u>Viewer/AngioViz</u> Original <u>Filmer</u> Original if No Mix Mode Not present if Mix Mode = Patient or Mix Mode = Study
Patient's Weight	(0010,1030)	3	<u>Viewer/AngioViz</u> Original <u>Filmer</u> Original if No Mix Mode Not present if Mix Mode = Patient or Mix Mode = Study

GE Healthcare

DIR 5479848-1EN REV 1

7.4.3 Common Series Entity Modules

7.4.3.1 General Series Module

This section specifies the Attributes that identify and describe general information about the Series within a Study.

TABLE 7-6 GENERAL SERIES MODULE ATTRIBUTES

Attribute Name	Tag	Type	Attribute Description
Modality	(0008,0060)	1	<u>Viewer/AngioViz</u> Original <u>Filmer</u> <ul style="list-style-type: none"> • Original if all Filmer data have the same defined modality • OT (Other) otherwise
Series Instance UID	(0020,000E)	1	Generated
Series Number	(0020,0011)	2	Generated
Series Date	(0008,0021)	3	Not present except for <u>AngioViz</u> : - Date of the creation of the series with the AngioViz SCPT's
Series Time	(0008,0031)	3	Not present except for <u>AngioViz</u> : - Time of the creation of the series with the AngioViz SCPT's

Series Description	(0008,103E)	3	<p><u>Viewer</u></p> <ul style="list-style-type: none"> For XA image, when the secondary capture image is generated per original image, the series description is set to the secondary capture image comments if valued: (0020,4000) “SCREEN SAVE” otherwise <p><u>Filmer</u></p> <p>User defined (AW Electronic film by default)</p> <p><u>AngioViz</u></p> <p>“AngioViz”</p>
Performing Physician Name	(0008,1050)	3	Not present
Operator’s Name	(0008,1070)	3	Name of the current user logged on the station, present only if the name encoding is compatible with the Specific Character Set specified.
Protocol Name	(0018,1030)	3	Not present except for <u>AngioViz</u> : - Equals Series Description (“AngioViz”)

7.4.4 Common Equipment Entity Modules

7.4.4.1 General Equipment Module

This section specifies the Attributes that identify and describe the piece of equipment that produced a Series of Images.

TABLE 7-7 GENERAL EQUIPMENT MODULE ATTRIBUTES

Attribute Name	Tag	Type	Attribute Description
Manufacturer	(0008,0070)	2	Copied from original image
Institution Name	(0008,0080)	3	<p><u>Viewer</u></p> <p>Copied from original image</p> <p><u>Filmer</u></p> <p>Copied from original image if No Mix Mode Empty if Mix Mode = Patient or Mix Mode = Study</p> <p><u>AngioViz</u></p> <p>Institution name configured on the AW</p>
Institution Address	(0008,0081)	3	<p><u>Viewer/AngioViz</u></p> <p>Copied from original image</p> <p><u>Filmer</u></p> <p>Copied from original image if No Mix Mode Empty if Mix Mode = Patient or Mix Mode = Study</p>
Station Name	(0008,1010)	3	<p>Copied from original image except for <u>AngioViz</u>: - Station Name of the AW</p>
Manufacturer’s Model Name	(0008,1090)	3	Model Name of the AW

Software Versions	(0018,1020)	3	Copied from original image except for <u>AngioViz</u> : - SW Version of the AW
-------------------	-------------	---	---

7.4.5 Common Image Entity Modules

7.4.5.1 General Image Module

This section specifies the Attributes that identify and describe an image within a particular series.

TABLE 7-8 GENERAL IMAGE MODULE ATTRIBUTES

Attribute Name	Tag	Type	Attribute Description
Instance Number	(0020,0013)	2	Generated
Patient Orientation	(0020,0020)	2C	See 7.4.5.1.1.1.
Content Date	(0008,0023)	2C	Derived from original image, except for <u>AngioViz</u> : Date of the creation of the AngioViz SCPT
Content Time	(0008,0033)	2C	Derived from original image, except for <u>AngioViz</u> : Time of the creation of the AngioViz SCPT
Image Type	(0008,0008)	3	See 7.4.5.1.1.2.
Source image Sequence	(0008,2112)	3	<u>Viewer/AngioViz</u> Set in Screen save image created by AW4.7 2D Multi-Modality Viewer <u>Filmer</u> Defined by the application that sends the image to the Filmer
>Referenced SOP Class UID	(0008,1150)	1C	SOP Class UID of the original image
>Referenced SOP Instance UID	(0008,1155)	1C	SOP Instance UID of the original image
>Referenced frame number	(0008,1160)	3	Not present, except for <u>AngioViz</u> : Multi-valued, as many values as number of frames used for the processing, i.e. (last_frame used - first-frame used + 1). The values are the frame numbers, i.e. first_frame\first_frame+1\first_frame+2...
>Distance Source to Detector	(0018,1110)	1C	Not present, except for <u>AngioViz</u> , Derived from original image
>Distance Source to Patient	(0018,1111)	3	Not present, except for <u>AngioViz</u> , Derived from original image
>Table Angle	(0018,1138)	3	Not present, except for <u>AngioViz</u> , Derived from original image
>Positioner Primary Angle	(0018,1510)	3	Not present, except for <u>AngioViz</u> , Derived from original image

>Positioner Secondary Angle	(0018,1511)	3	Not present, except for <u>AngioViz</u> , Derived from original image
Burned In Annotation	(0028, 0301)	3	YES
Image Comments	(0020,4000)	3	For XA modality, application defined (based on original value). For AngioViz, IMG_DESCRIPTION, or empty field Otherwise, not defined

7.4.5.1.1 General Image Attribute Descriptions

7.4.5.1.1.1 Patient Orientation

Derived from original if Screen Save Viewer/AngioViz.

Empty if Filmer

7.4.5.1.1.2 Image Type

If a third value is defined in the original DICOM Image Type, then the image type is set to:

DERIVED\SECONDARY\

If no third value is defined in the original DICOM Image Type or if the Image Type is empty, then the image type is set to:

DERIVED\SECONDARY\SCREEN SAVE

7.4.5.1.1.3 Derivation Description

This field is not encoded

7.4.5.2 Image Pixel Module

This section specifies the Attributes that describe the pixel data of the image.

TABLE 7-9 IMAGE PIXEL MODULE ATTRIBUTES

Attribute Name	Tag	Type	Attribute Description
Samples per Pixel	(0028,0002)	1	1 - if image is displayed in levels of gray 3 - if image is displayed in full colors
Photometric Interpretation	(0028,0004)	1	Set to MONOCHROME1 if the minimum pixels value 0=white and the element (0028, 0002) is set to the value 1. Set to MONOCHROME2 if the minimum pixels value 0=black and the element (0028, 0002) is set to the value 1. Set to RGB If the element (0028, 0002) is set to the value of 3.

Planar Configuration	(0028, 0006)	1C	0, if element (0028, 0002) is 3 Not present otherwise
Pixel Aspect Ratio	(0028, 0034)	1C	Derived from original image. Not present if equal to 1\1
Rows	(0028,0010)	1	<u>Viewer/AngioViz</u> If original image rows < 512, then 512 If 512<= original image rows <= 2560, then original image rows If 2560 < original image rows, then 2560 <u>Filmer</u> If original image rows < 256, then 256 If 256 <= original image rows <= 2560, then original image rows If 2560 < original image rows, then 2560
Columns	(0028,0011)	1	<u>Viewer/AngioViz</u> If original image columns < 512, then 512 If 512<= original image columns <= 2560, then original image columns If 2560 < original image columns, then 2560 <u>Filmer</u> If original image columns < 256, then 256 If 256 <= original image columns <= 2560, then original image columns If 2560 < original image columns, then 2560
Bits Allocated	(0028,0100)	1	Copy of original image <i>Bits Allocated</i> value or 8 if the element (0028, 0002) has value 3.
Bits Stored	(0028,0101)	1	Copy of original image <i>Bits Stored</i> value or 8 if the element (0028, 0002) has value 3
High Bit	(0028,0102)	1	Bits Stored - 1
Pixel Representation	(0028,0103)	1	Copy of original image <i>Pixel Representation</i> value or 0000h if the element (0028, 0002) has value 3
Pixel Data	(7FE0,0010)	1	Derived from original pixel data

7.4.5.2.1 Image Pixel Module Augmentation

This section specified the DICOM tags added for the Secondary Captures in the Image Pixel Module.

Pixel Spacing	(0028,0030)	3	Derived from the original image <i>Pixel Size</i> if defined in original image Not Present if <i>Pixel Size</i> is not defined in original image
---------------	-------------	---	---

7.4.6 Overlay Plan Modules

This module is not implemented for this IOD.

7.4.7 Lookup Table Modules

7.4.7.1 VOI LUT module

This section specifies the Attributes that describe the VOI LUT.

TABLE 7-10 VOI LUT MODULE ATTRIBUTES

Attribute Name	Tag	Type	Attribute Description
VOI LUT Sequence	(0028, 3010)	3	Present when the image displayed uses a private VOI LUT or when present in the original image.
> LUT Descriptor	(0028, 3002)	1C	See 7.4.7.1.1
> LUT Data	(0028, 3006)	1C	The VOI LUT Data in the item. If the number of data is $< 2^{16}-1$, then the Value Representation is set to US. If the number of data is $> 2^{16}-1$, then the Value Representation is set to OW.
Window Center	(0028,1050)	3	Current <i>Window Center (WL)</i> + value of element (0x0028,0x1052) of original image if found in the original image header. This element is applicable only with <i>Photometric Interpretation</i> (0x0028,0x0004) value of MONOCHROME1 and MONOCHROME2 otherwise this element is <i>Not Present</i>
Window Width	(0028,1051)	1C	If <i>Window Width</i> (0x0028,0x1050) value is stored a window width value is stored in this element. This element is written only with <i>Photometric Interpretation</i> (0x0028,0x0004) value of MONOCHROME1 and MONOCHROME2 otherwise this element is <i>Not Present</i>

Note: When the VOI LUT Sequence is present in the image, there is always only one item present in this sequence.

7.4.7.1.1 Description of the LUT descriptor

The first value is set to the number of entries in the look up table. It is set to 0 if the number of entries is equal to 2^{16} .

The second value is set to the first input value mapped.

The third value is always 16.

If the possible range after application of rescale slope/rescale intercept is signed, the Value Representation is set to SS. Otherwise, the Value Representation is set to US.

GE Healthcare

DIR 5479848-1EN REV 1

7.4.7.2 Modality LUT module

This section specifies the Attributes that describe the Modality LUT.

TABLE 7-11 MODALITY LUT MODULE ATTRIBUTES

Attribute Name	Tag	Type	Attribute Description
Rescale Intercept	(0028,1052)	1C	If original image header contains <i>Rescale intercept</i> value then the SC image contains its copy or the element is <i>Not applicable</i> if the element (0028, 0002) has value 3 or, if neither condition can be satisfied this element is <i>Not Present</i> .
Rescale Slope	(0028,1053)	1C	If original image header contains <i>Rescale slope</i> value then the SC image contains its copy or the element is <i>Not applicable</i> if the element (0028, 0002) has value 3 or, if neither condition can be satisfied this element is <i>Not Present</i> .
Rescale Type	(0028,1054)	1C	If the element (0028, 0002) has value of 3 or if the image header does not contain <i>Rescale intercept</i> , this element is not present, otherwise it is set to US.

7.4.8 General Modules

7.4.8.1 SOP Common Module

This section defines the Attributes that are required for proper functioning and identification of the associated SOP Instances. They do not specify any semantics about the Real-World Object represented by the IOD.

TABLE 7-12 SOP COMMON MODULE ATTRIBUTES

Attribute Name	Tag	Type	Attribute Description
SOP Class UID	(0008,0016)	1	1.2.840.10008.5.1.4.1.1.7
SOP Instance UID	(0008,0018)	1	Generated from GE Based UID: <station configuration> and timestamp
Specific Character Set	(0008,0005)	1C	<ul style="list-style-type: none"> If original field is not present: <ul style="list-style-type: none"> Set to ISO_IR 100 if some fields contain non-English characters. Otherwise the field is not generated If original field is present, original value <p>NOTE: Multi valued Specific Character Set with first value non-null and Specific Character Set ISO_IR 13 are not supported.</p>

7.4.9 SC Modules

This Section describes SC Equipment, and Image Modules. These Modules contain Attributes that are specific to SC Image IOD.

GE Healthcare

DIR 5479848-1EN REV 1

7.4.9.1 SC Equipment Module

This Module describes equipment used to convert images into a DICOM format.

TABLE 7-13 SC IMAGE EQUIPMENT MODULE ATTRIBUTES

Attribute Name	Tag	Type	Attribute Description
Conversion Type	(0008,0064)	1	WSD
Modality	(0008,0060)	3	Original if Screen Save Image Original if all Filmer data have the same defined modality, OT otherwise
Secondary Capture Device ID	(0018,1010)	3	Real station host name
Secondary Capture Device Manufacturer	(0018,1016)	3	GE MEDICAL SYSTEMS
Secondary Capture Device Manufacturer's Model Name	(0018,1018)	3	Filmer FILMER_5 Viewer / AngioViz VIEWER_5
Secondary Capture Device Software Version	(0018,1019)	3	Application defined (Software version build identifier)

7.4.9.2 SC Image Module

The table in this Section contains IOD Attributes that describe SC images.

TABLE 7-14 SC IMAGE MODULE ATTRIBUTES

Attribute Name	Tag	Type	Attribute Description
Date of Secondary Capture	(0018,1012)	3	Creation date of the Secondary Capture
Time of Secondary Capture	(0018,1014)	3	Creation time of the Secondary Capture

7.5 SC-PRIVATE DATA DICTIONARY

This section describes the private attributes of this IOD.

TABLE 7.5-1 PRIVATE CREATOR IDENTIFICATION: GEMS_IDEN_01

Attribute Name	Tag	Type	VR	VM
Full fidelity	(0009,xx01)	3	LO	1
Suite id	(0009,xx02)	3	SH	1
Product id	(0009,xx04)	3	SH	1
Image actual date	(0009,xx27)	3	SL	1
Service id	(0009,xx30)	3	SH	1
Mobile location number	(0009,xx31)	3	SH	1
Equipment UID	(0009,xxE3)	3	UI	1
Genesis Version - now	(0009, xxE6)	3	SH	1
Exam Record checksum	(0009, xxE7)	3	UL	1
Series Suite Id	(0009, xxE8)	3	SH	1
Actual series data time stamp	(0009, xxE9)	3	SL	1

TABLE 7.5-3 PRIVATE CREATOR IDENTIFICATION: GEMS_RELA_01

Attribute Name	Tag	Type	VR	VM
Series from which Prescribed	(0021,xx03)	3	SS	1
Genesis Version - now	(0021,xx05)	3	SH	1
Series Record checksum	(0021,xx07)	3	UL	1
Screen Format	(0021,xx37)	3	SS	1

TABLE 7.5-4 PRIVATE CREATOR IDENTIFICATION: GEMS_SERS_01

Attribute Name	Tag	Type	VR	VM
Images in Series	(0025,xx07)	3	SL	1
Last Instance Number used	(0025,xx19)	3	SL	1
Primary Receiver Suite and Host	(0025,xx1A)	3	SH	1

TABLE 7.5-5 PRIVATE CREATOR IDENTIFICATION: GEMS_IMPS_01

Attribute Name	Tag	Type	VR	VM
Version of the hdr struct	(0029,xx26)	3	SS	1
Advantage comp. Overflow	(0029,xx34)	3	SL	1
Advantage comp. Underflow	(0029,xx35)	3	SL	1

TABLE 7.5-6 PRIVATE CREATOR IDENTIFICATION: GEMS_PARM_01

Attribute Name	Tag	Type	VR	VM
Decon kernel parameters	(0043,xx13)	3	SS	5

TABLE 7.5-7 PRIVATE CREATOR IDENTIFICATION: DLX_SERIE_01
ONLY IN ANGIOVIZ

Attribute Name	Tag	Type	VR	VM
Angle value 1	(0019,xx01)	3	DS	1
Angle value 2	(0019,xx02)	3	DS	1
Angle value 3	(0019,xx03)	3	DS	1
Table vertical position	(0019,xx21)	3	DS	1
Table longitudinal position	(0019,xx22)	3	DS	1
Table lateral position	(0019,xx23)	3	DS	1

TABLE 7.5-8 PRIVATE CREATOR IDENTIFICATION: GEMS_DL_IMG_01

Attribute Name	Tag	Type	VR	VM
Acquisition plane	(0019,xxDE)	3	CS	1
Only for AngioViz				
table cradle tilt angle	(0019,xxBC)	3	FL	1
table rotation angle	(0019,xxEA)	3	FL	1
Table X Position to Isocenter	(0019,xxEB)	3	FL	1

Table Y Position to Isocenter	(0019,xxEC)	3	FL	1
Table Z Position to Isocenter	(0019,xxED)	3	FL	1
table head tilt angle	(0019,xxEE)	3	FL	1
patient position per image	(0019,xxC7)	3	CS	1

**TABLE 7.5-9 PRIVATE CREATOR IDENTIFICATION: GEMS_INTVL_FLOW_01
 ONLY IN ANGIOVIZ**

Attribute Name	Tag	Type	VR	VM
AngioViz Processing Mode	(0033,xx01)	3	CS	1
AngioViz Mask Frame	(0033,xx02)	3	IS	1
AngioViz First Frame	(0033,xx03)	3	IS	1
AngioViz Last Frame	(0033,xx04)	3	IS	1
AngioViz Contrast Agent	(0033,xx05)	3	CS	1
AngioViz Saturation Percentage	(0033,xx06)	3	FL	1
AngioViz Time Zero Frame	(0033,xx07)	3	IS	1
AngioViz Maximum Time	(0033,xx08)	3	FL	1
AngioViz Algorithm version	(0033,xx09)	3	LO	1

Note: These elements are present in the generated Secondary Capture if these elements were present in the original images

8. ENHANCED SR INFORMATION OBJECT IMPLEMENTATION

8.1 INTRODUCTION

This section specifies the use of the DICOM Enhanced SR IOD to represent the information included in Enhanced SR produced by this implementation. Corresponding attributes are conveyed using the module construct.

The enhanced SR is a way for the Filmer to generate Electronic Film and reload it, using DICOM standard.

The contents of this section are:

8.2- ENHANCED SR Entity-Relationship Model

8.3- ENHANCED SR-IOD MODULE TABLE

8.4- ENHANCED SR -INFORMATION MODULE DEFINITIONS

8.5- ENHANCE SR – PRIVATE DATA DICTIONARY

8.6- ENHANCE SR – TEMPLATE IDENTIFICATION

8.7- ENHANCE SR - Private Coded Entries

Note: The Enhanced DICOM SR produced by this implementation is also named: “Electronic Film”

8.2 ENHANCED SR ENTITY-RELATIONSHIP MODEL

The Entity-Relationship diagram for the ENHANCED SR interoperability schema is shown in **Illustration 8.2.1**. In this figure, the following diagrammatic convention is established to represent the information organization:

- Each entity is represented by a rectangular box
- Each relationship is represented by a diamond shaped box.
- The fact that a relationship exists between two entities is depicted by lines connecting the corresponding entity boxes to the relationship boxes.

The relationships are fully defined with the maximum number of possible entities in the relationship shown. In other words, the relationship between Series and Image can have up to n Images per Series, but the Patient to Study relationship has 1 Study for each Patient (a Patient can have more than one Study on the system, however each Study will contain all of the information pertaining to that Patient).

ILLUSTRATION 8.2-1
ENHANCED SR IMAGE ENTITY RELATIONSHIP DIAGRAM

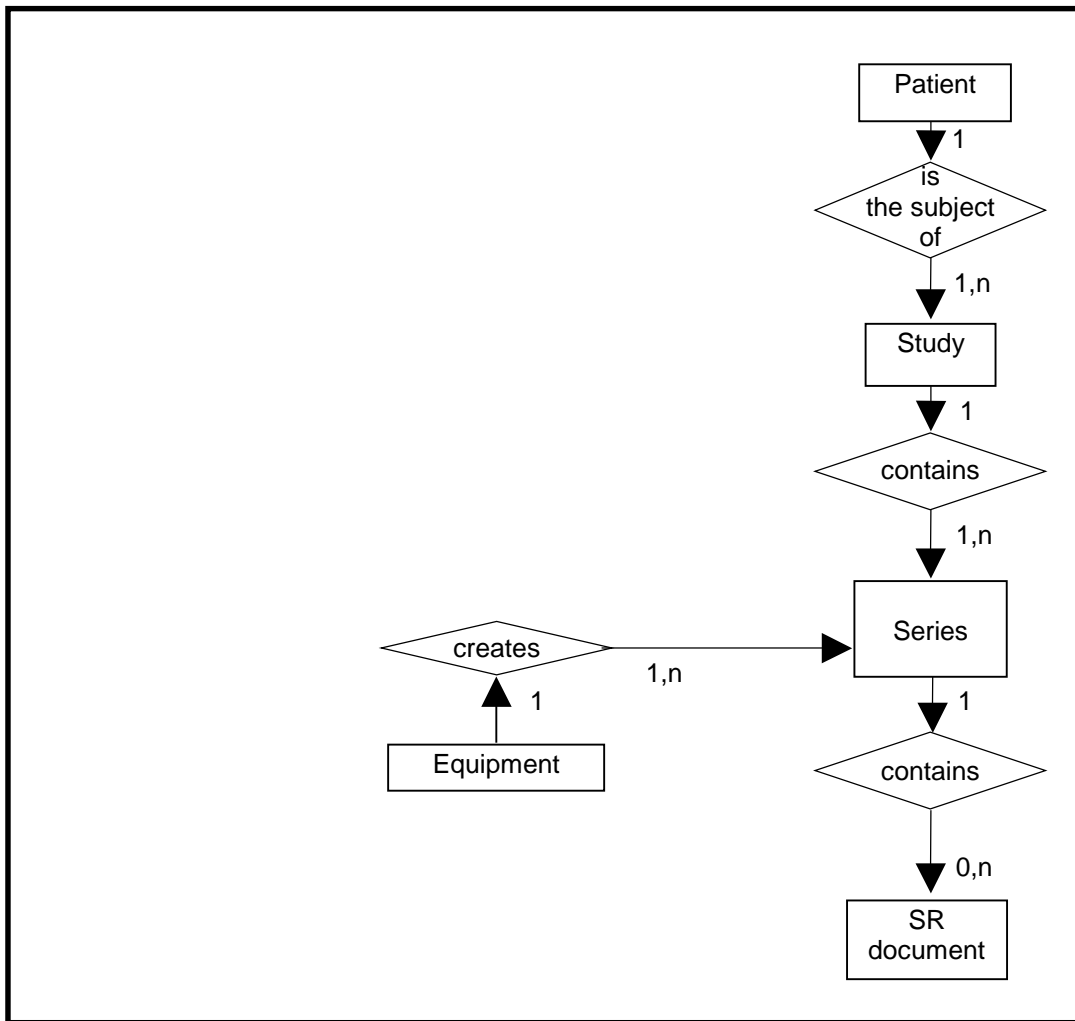

8.2.1 ENTITY DESCRIPTIONS

Please refer to DICOM Standard Part 3 (Information Object Definitions) for a description of each of the entities contained within the ENHANCED SR Information Object.

8.2.2 Advantage Workstation 4.7 Mapping of DICOM entities

TABLE 8-1 MAPPING OF DICOM ENTITIES TO ADVANTAGE WORKSTATION 4.7 ENTITIES

DICOM	Advantage Workstation 4.7 Entity
Patient	Patient
Study	Exam
Series	Series
Equipment	Equipment
SR document	SR document

8.3 ENHANCED SR-IOD MODULE TABLE

Within an entity of the DICOM ENHANCED SR IOD, attributes are grouped into related set of attributes. A set of related attributes is termed a module. A module facilitates the understanding of the semantics concerning the attributes and how the attributes are related with each other. A module grouping does not infer any encoding of information into datasets.

Table 8.3.1 identifies the defined modules within the entities which comprise the DICOM SR IOD. Modules are identified by Module Name.

See DICOM Part 3 for a complete definition of the entities, modules, and attributes.

TABLE 8-2 ENHANCED SR DOCUMENT IOD MODULES

Entity Name	Module Name	Reference
Patient	Patient	8.4.1.1
	Specimen Identification	N/A
	Clinical Trial Subject	N/A
Study	General Study	9.4.2.1
	Patient Study	8.4.2.2
	Clinical Trial Study	N/A
Series	SR document Series	8.4.3.1
	Clinical Trial Series	N/A
Equipment	General Equipment	8.4.4.1
Document	SR document General	8.4.5.1
	SR document Content	8.4.5.2
	SOP Common	8.4.6.1

8.4 ENHANCED SR -INFORMATION MODULE DEFINITIONS

Please refer to DICOM Standard Part 3 (Information Object Definitions) for a description of each of the entities and modules contained within the ENHANCED SR Information Object.

The following modules are included to convey Enumerated Values, Defined Terms, and Optional Attributes supported. Type 1 & Type 2 Attributes are also included for completeness and to define what values they may take and from where these values are obtained. It should be noted that they are the same ones as defined in the DICOM Standard Part 3 (Information Object Definitions).

An Electronic Film is a DICOM ENHANCED SR IOD generated by the application 'Filmer' of Advantage Workstation 4.7.

In the following chapter, all new study, series and image instance UID are generated from Filmer base UID: **1.2.840.113619.2.377**

Note: Elements not listed are not supported

8.4.1 Common Patient Entity Modules

8.4.1.1 Patient Module

This section specifies the attributes of the Patient that describe and identify the Patient who is the subject of a diagnostic Study. This Module contains attributes of the patient that are needed for diagnostic interpretation of the Image and are common for all studies performed on the patient.

TABLE 8-3 PATIENT MODULE ATTRIBUTES

Attribute Name	Tag	Type	Attribute Description
Patient's Name	(0010,0010)	2	Patient name of first referenced image if No Mix Mode or Mix Mode = Study User defined if Mix Mode = Patient
Patient ID	(0010,0020)	2	Patient ID of first referenced image if No Mix Mode or Mix Mode = Study Function of pid and time if Mix Mode = Patient
Issuer of Patient ID	(0010,0021)	3	Not filled
Issuer of Patient ID Qualifiers Sequence	(0010,0024)	3	Not filled
Patient's Birth Date	(0010,0030)	2	Patient's Birth Date of first referenced image if No Mix Mode or Mix Mode = Study Empty if Mix Mode = Patient
Patient's Sex	(0010,0040)	2	Patient's Sex of first referenced image if No Mix Mode or Mix Mode = Study Empty if Mix Mode = Patient
Other Patient IDs	(0010,1000)	3	Not filled
Other Patient Ids Sequence	(0010,1002)	3	Not filled

8.4.2 Common Study Entity Modules

The following Study IE Modules are common to all Composite Image IODs that reference the Study IE.

8.4.2.1 General Study Module

This section specifies the Attributes, which describe and identify the Study performed upon the Patient.

TABLE 8-4 GENERAL STUDY MODULE ATTRIBUTES

Attribute Name	Tag	Type	Notes
Study Instance UID	(0020,000D)	1	Original if No Mix Mode Generated if Mix Mode = Patient or Mix Mode = Study
Study Date	(0008,0020)	2	Study Date of first referenced image (Empty if does not exist) if No Mix Mode Empty if Mix Mode = Patient or Mix Mode = Study
Study Time	(0008,0030)	2	Study Time of first referenced image (Empty if does not exist) if No Mix Mode Empty if Mix Mode = Patient or Mix Mode = Study
Accession Number	(0008,0050)	2	Accession Number of first referenced image (Empty if does not exist) if No Mix Mode Empty if Mix Mode = Patient or Mix Mode = Study
Referring Physician's Name	(0008,0090)	2	Referring Physician's Name of first referenced image (Empty if does not exist) if No Mix Mode Semantically empty if Mix Mode = Patient or Mix Mode = Study (The content may be empty or contain only ^)
Study Description	(0008,1030)	3	Study Description of first referenced image (Empty if does not exist) if No Mix Mode User defined if Mix Mode = Patient or Mix Mode = Study
Study ID	(0020,0010)	2	Study ID of first referenced image (Empty if does not exist) if No Mix Mode Generated if Mix Mode = Patient or Mix Mode = Study

8.4.2.2 Patient Study Module

This section defines Attributes that provide information about the Patient at the time the Study was performed.

TABLE 8-5 PATIENT STUDY MODULE ATTRIBUTES

Attribute Name	Tag	Type	Attribute Description
Patient's Age	(0010,1010)	3	Patient's Age of first referenced image if No Mix Mode Not present if Mix Mode = Patient or Mix Mode = Study
Patient's Size	(0010,1020)	3	Patient's Size of first referenced image if No Mix Mode Not present if Mix Mode = Patient or Mix Mode = Study
Patient's Weight	(0010,1030)	3	Patient's Weight of first referenced image if No Mix Mode Not present if Mix Mode = Patient or Mix Mode = Study

8.4.3 SR Document Series Entity Modules

The following SR Document Series IE Modules are common to all Composite Image IODs that reference the SR Document Series IE.

8.4.3.1 SR Document Series Module

This section specifies the attributes that identify and describe general information about the SR Document Series within a Study.

TABLE 8-6 SR DOCUMENT SERIES MODULE ATTRIBUTES

Attribute Name	Tag	Type	Attribute Description
Modality	(0008,0060)	1	SR
Series Instance UID	(0020,000E)	1	Generated
Series Number	(0020,0011)	1	Generated
Referenced Performed Procedure Step Sequence	(0008,1111)	2	Empty
Series Description	(0008,103E)	3	User defined, filled by default with "AW Electronic Film"
Series Date	(0008,0021)	3	Not present
Series Time	(0008,0031)	3	Not present

Note: The series description is also present in the content of the SR. (See AW41 EF TID template description in section 7.6)

8.4.4 Common Equipment Entity Modules

The following Equipment IE Module is common to all Composite Image IODs that reference the Equipment IE.

8.4.4.1 General Equipment Module

This section specifies the attributes that identify and describe the piece of equipment that produced a Series of Images.

TABLE 8-7 GENERAL EQUIPMENT MODULE ATTRIBUTES

Attribute Name	Tag	Type	Attribute Description
Manufacturer	(0008,0070)	2	GE MEDICAL SYSTEMS
Institution Name	(0008,0080)	3	Hospital Name provided on the platform
Station Name	(0008,1010)	3	Host name provided on the platform
Manufacturer's Model Name	(0008,1090)	3	FILMER_5
Software Versions	(0018,1020)	3	Application defined (Software version build identifier)

8.4.5 SR document Entity Modules

The following SR document Modules are common to all Composite Image IODs that reference the Image IE.

8.4.5.1 SR document General

This section specifies the attributes that identify and describe the SR document.

TABLE 8-8 SR DOCUMENT GENERAL MODULE ATTRIBUTES

Attribute Name	Tag	Type	Attribute Description
Instance Number	(0020, 0013)	1	Generated
Completion flag	(0040, A491)	1	COMPLETE
Verification flag	(0040, A493)	1	VERIFIED
Content Date	(0008, 0023)	1	Generated at the date when the Electronic film is created
Content Time	(0008, 0033)	1	Generated at the time when the Electronic film is created
Verifying Observer Sequence	(0040,A073)	1C	
> Verifying Observer Name	(0040,A075)	1	Name of the user that currently is logged on the station
> Verifying Observer Code Sequence	(0040,A088)	2	Empty
> Verifying Organization	(0040,A027)	1	Institution Name (0008,0080) of General Equipment Module
> Verifying Date Time	(0040,A030)	1	Generated at the time when the Electronic film is created
Performed Procedure Code Sequence	(0040, A372)	2	Empty
Current Requested Procedure Evidence Sequence	(0040,A375)	1C	List of images from all studies considered as input of the Electronic Film

GE Healthcare

DIR 5479848-1EN REV 1

> Study Instance UID	(0020,000D)	1	Refer to (0040,A375)
> Referenced Series Sequence	(0008,1115)	1	Refer to (0040,A375)
>> Series Instance UID	(0020,000E)	1	Refer to (0040,A375)
>> Referenced SOP Sequence	(0008,1199)	1	Refer to (0040,A375)
>>> Referenced SOP Class UID	(0008,1150)	1	Refer to (0040,A375)
>>> Referenced SOP Instance UID	(0008,1155)	1	Refer to (0040,A375)

8.4.5.2 SR Document Content Module

This section specifies the attributes that identify and describe the SR content

TABLE 8-9 SR DOCUMENT CONTENT MODULE ATTRIBUTES

Attribute Name	Tag	Type	Attribute Description
Content Template Sequence	(0040, A504)	1C	Template that describes the content of the content item
> Mapping Resource	(0008, 0105)	1	PRIVATE
> Template Identifier	(0040, DB00)	1	AW41 EF TID
Content Sequence	(0040, A730)	1C	Content of the DICOM SR
Value Type	(0040, A040)	1	CONTAINER
Concept Name code Sequence	(0040, A043)	1C	
> Code Value	(0008, 0100)	1C	AWVF-0001
> Coding Scheme Designator	(0008, 0102)	1C	99GEMS
> Code Meaning	(0008, 0104)	1C	Electronic Film Presentation
Continuity Of Content	(0040, A050)	1C	SEPARATE

8.4.6 General Modules

The SOP Common Module is mandatory for all DICOM IODs.

8.4.6.1 SOP Common Module

This section defines the Attributes that are required for proper functioning and identification of the associated SOP Instances. They do not specify any semantics about the Real-World Object represented by the IOD.

TABLE 8-10 SOP COMMON MODULE ATTRIBUTES

Attribute Name	Tag	Type	Attribute Description
SOP Class UID	(0008,0016)	1	1.2.840.10008.5.1.4.1.1.88.22
SOP Instance UID	(0008,0018)	1	Generated from GE Based UID, <station configuration> and timestamp.
Specific Character Set	(0008,0005)	1C	<ul style="list-style-type: none"> • ISO_IR 100 if Mix Mode = Patient • Otherwise: <ul style="list-style-type: none"> • ISO_IR 100 if original value is not present and at least one of the Dicom data element contains non-ascii characters. • Original value otherwise <p>Note: Multi valued Specific Character Set with first value non-null and Specific Character Set ISO_IR 13 are not supported.</p>

8.5 ENHANCE SR – PRIVATE DATA DICTIONARY

This section describes the private attributes of this IOD.

TABLE 8-11 PRIVATE CREATOR IDENTIFICATION: GEMS_ADWSOFT_DPO1

Attribute Name	Tag	Type	VR	VM	Attribute Description
Private Entity Launch Command	(0039,xx95)	3	LO	1	Name of application to launch

8.6 ENHANCE SR – TEMPLATE IDENTIFICATION

This section describes the Electronic Film Presentation Template

This template describes how the SR Document Content Module of the Enhanced SR Information Object Definition is constrained for the purpose of implementing the Electronic Film. This template is non-standard, Mapping Resource (0008,0105) = PRIVATE, Template Identifier (0040,DB00) = AW41 EF TID.

8.6.1 TID Electronic Film Presentation

	NL	Rel with Parent	VT	Concept Name	VM	Req Type	Condition	Value Set Constraint
1			CONTAINER	EV(AWVF-0001,99GEMS, "Electronic Film Presentation")	1	M		Root Node, SEPARATE

	NL	Rel with Parent	VT	Concept Name	VM	Req Type	Condition	Value Set Constraint
2	>	HAS OBS CONTEXT	INCLUDE	DTID (1003) Person observer identifying attributes	1	M		
3	>	CONTAINS	INCLUDE	ETID Page Presentation	1-n	U		
4	>	HAS CONCEPT MOD	CODE	EV (113011, DCM, "Document Title Modifier")	1	MC		Present and equal to (0008,103E)

8.6.2 TID Page Presentation

	NL	Rel with Parent	VT	Concept Name	VM	Req Type	Condition	Value Set Constraint
1		-	CONTAINER	EV(AWVF-0002, 99GEMS, "Page Presentation")	1	M		SEPARATE
2	>	CONTAINS	INCLUDE	ETID Slot Group Presentation	1-n	U		

8.6.3 TID Slot Group Presentation

	NL	Rel with Parent	VT	Concept Name	VM	Req Type	Condition	Value Set Constraint
1		-	CONTAINER	EV(AWVF-0003, 99GEMS, "Slot Group Presentation")	1	M		SEPARATE
2	>	CONTAINS	INCLUDE	ETID Geometry	1	M		
3	>	CONTAINS	INCLUDE	ETID Slot Presentation	1-n	U		

8.6.4 TID Slot Presentation

	NL	Rel with Parent	VT	Concept Name	VM	Req Type	Condition	Value Set Constraint
1		-	CONTAINER	EV(AWVF-0004, 99GEMS, "Slot Presentation")	1	M		SEPARATE
2	>	CONTAINS	INCLUDE	ETID Geometry	1	M		
3	>	CONTAINS	TEXT	EV(AWVF-0009, 99GEMS, "Notepad")	1	UC	IF rows 4 and 5 absent	
4	>	CONTAINS	IMAGE		1	UC	IF rows 3 and 5 absent	
5	>	-	INCLUDE	ETID Cine Sequence	1	UC	IF rows 3 and 4 absent	

8.6.5 TID Cine Sequence

	NL	Rel with Parent	VT	Concept Name	VM	Req Type	Condition	Value Set Constraint
1		CONTAINS	NUM	EV(AWVF-0010, 99GEMS, "Time between cine frames")	1	M		UNITS=EV(s, UCUM, "second")
2		CONTAINS	IMAGE		1-n	M		

GE Healthcare

DIR 5479848-1EN REV 1

8.6.6 TID Geometry

	NL	Rel with Parent	VT	Concept Name	VM	Req Type	Condition	Value Set Constraint
1		-	NUM	EV(AWVF-0005, 99GEMS, "Relative horizontal position of top left corner")	1	M		UNITS=EV(1, UCUM, "ratio")
2		-	NUM	EV(AWVF-0006, 99GEMS, "Relative vertical position of top left corner")	1	M		UNITS=EV(1, UCUM, "ratio")
3		-	NUM	EV(AWVF-0007, 99GEMS, "Relative horizontal size")	1	M		UNITS=EV(1, UCUM, "ratio")
4		-	NUM	EV(AWVF-0008, 99GEMS, "Relative vertical size")	1	M		UNITS=EV(1, UCUM, "ratio")

8.7 ENHANCE SR - PRIVATE CODED ENTRIES

The private coded entries that are required for implementing the Electronic Film are listed below (these are referred to in the Electronic Film Presentation Template).

TABLE 8-12 PRIVATE CODED ENTRIES: 99GEMS

Coded Entries		
Coding Scheme Designator (0008,0102)	Code Value (0008,0100)	Code Meaning (0008,0104)
99GEMS	AWVF-0001	Electronic Film Presentation
99GEMS	AWVF-0002	Page Presentation
99GEMS	AWVF-0003	Slot Group Presentation
99GEMS	AWVF-0004	Slot Presentation
99GEMS	AWVF-0005	Relative horizontal position of top left corner
99GEMS	AWVF-0006	Relative vertical position of top left corner
99GEMS	AWVF-0007	Relative horizontal size
99GEMS	AWVF-0008	Relative vertical size
99GEMS	AWVF-0009	Notepad
99GEMS	AWVF-0010	Time between cine frames

9. KEY OBJECT SELECTION INFORMATION OBJECT IMPLEMENTATION

9.1 INTRODUCTION

This section specifies the use of the DICOM Key Object Selection IOD to represent the information included in KOS produced by this implementation. Corresponding attributes are conveyed using the module construct.

KOS: Key Object Selection - Is used to flag significant images. The radiologist selects Key Images, and creates appropriate Notes. The referring physician views the Key Image Note prepared by radiologist.

The Viewer works on original images, while the Filmer can concatenate in the same series derived images coming from multiple applications and series.

Therefore the DICOM mapping reflecting these differences is different.

The contents of this section are:

9.2 - KEY OBJECT SELECTION Entity-Relationship Model

9.3 - KEY OBJECT SELECTION-IOD MODULE TABLE

9.4 - KEY OBJECT SELECTION -INFORMATION MODULE DEFINITIONS

9.5 - KEY OBJECT SELECTION – TEMPLATE IDENTIFICATION

9.2 KEY OBJECT SELECTION ENTITY-RELATIONSHIP MODEL

The Entity-Relationship diagram for the Key Object Selection interoperability schema is shown in **Illustration 9.2.1**. In this figure, the following diagrammatic convention is established to represent the information organization:

- Each entity is represented by a rectangular box
- Each relationship is represented by a diamond shaped box.
- The fact that a relationship exists between two entities is depicted by lines connecting the corresponding entity boxes to the relationship boxes.

The relationships are fully defined with the maximum number of possible entities in the relationship shown. In other words, the relationship between Series and Image can have up to n Images per Series, but the Study to Patient relationship has 1 Patient for each Study (a Patient can have more than one Study on the system, however each Study will contain all of the information pertaining to that Patient).

ILLUSTRATION 9.2-1
KEY OBJECT SELECTION IMAGE ENTITY RELATIONSHIP DIAGRAM

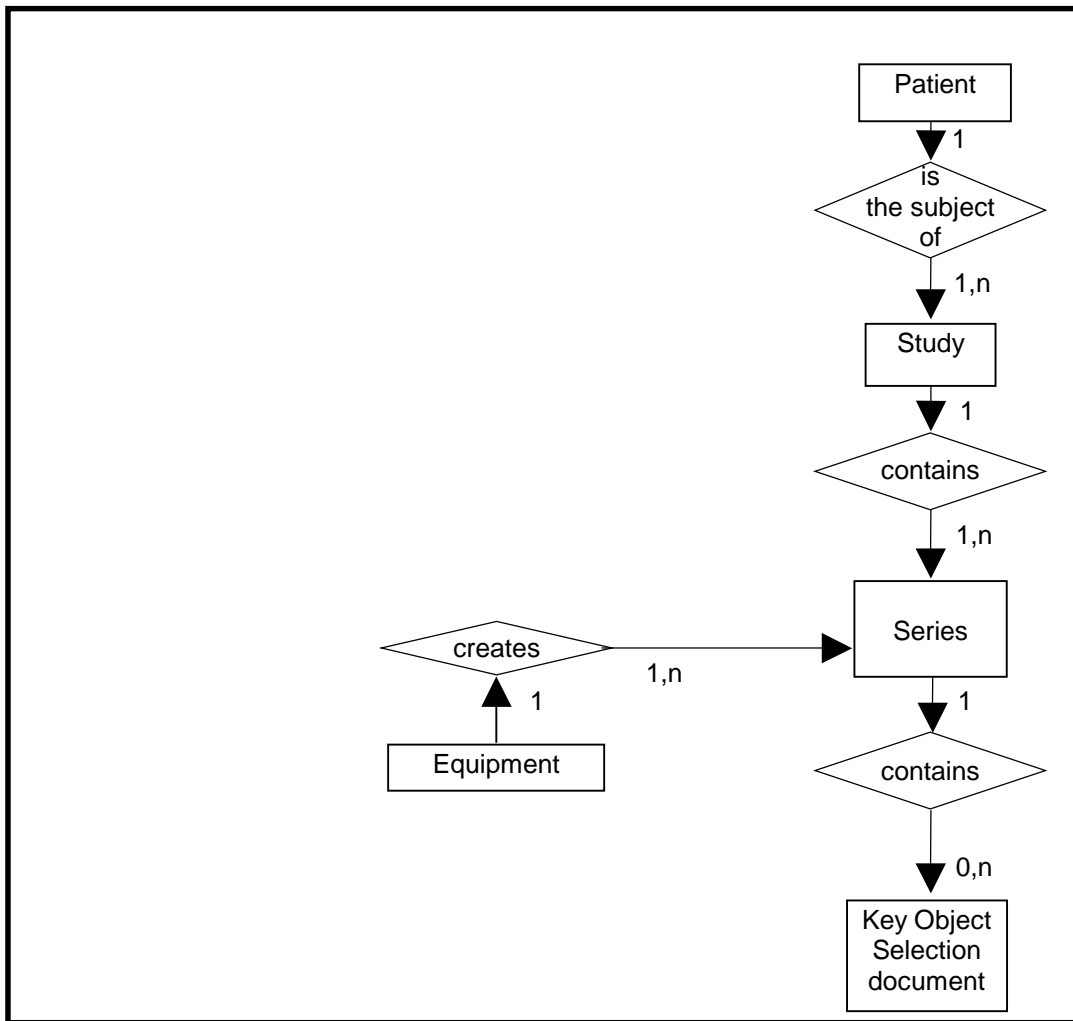

9.2.1 ENTITY DESCRIPTIONS

Please refer to DICOM Standard Part 3 (Information Object Definitions) for a description of each of the entities contained within the Key Object Selection Information Object.

9.2.2 Advantage Workstation 4.7 Mapping of DICOM entities

TABLE 9-1 MAPPING OF DICOM ENTITIES TO ADVANTAGE WORKSTATION 4.7 ENTITIES

DICOM	Advantage Workstation 4.7 Entity
Patient	Patient
Study	Exam
Series	Series
Equipment	Equipment
Key Object Selection document	Key Object Selection document

9.3 KEY OBJECT SELECTION-IOD MODULE TABLE

Within an entity of the DICOM KEY OBJECT SELECTION IOD, attributes are grouped into related set of attributes. A set of related attributes is termed a module. A module facilitates the understanding of the semantics concerning the attributes and how the attributes are related with each other. A module grouping does not infer any encoding of information into datasets.

Table 9.3.1 identifies the defined modules within the entities which comprise the DICOM KEY OBJECT SELECTION IOD. Modules are identified by Module Name.

See DICOM Part 3 for a complete definition of the entities, modules, and attributes.

TABLE 9-2 KEY OBJECT SELECTION DOCUMENT IOD MODULES

Entity Name	Module Name	Reference
Patient	Patient	9.4.1.1
	Specimen Identification	N/A
	Clinical Trial Subject	N/A
Study	General Study	9.4.2.1
	Patient Study	9.4.2.2
	Clinical Trial Study	N/A
Series	Key Object Document Series	9.4.3.1
	Clinical Trial Series	N/A
Equipment	General Equipment	9.4.4.1
Document	Key Object Document	9.4.5.1
	SR document Content	10.4.5.2
	SOP Common	9.4.6.1

9.4 KEY OBJECT SELECTION -INFORMATION MODULE DEFINITIONS

Please refer to DICOM Standard Part 3 (Information Object Definitions) for a description of each of the entities and modules contained within the KEY OBJECT SELECTION Information Object.

The following modules are included to convey Enumerated Values, Defined Terms, and Optional Attributes supported. Type 1 & Type 2 Attributes are also included for completeness and to define what values they may take and from where these values are obtained. It should be noted that they are the same ones as defined in the DICOM Standard Part 3 (Information Object Definitions).

The Key Object Selection IOD described here is the one generated by the applications 'Viewer' and 'Filmer' of Advantage Workstation 4.7.

In the following chapter, all new study, series and image instance UID are generated from AW4.7 2D Multi-Modality Viewer base UID: **1.2.840.113619.2.378**, and AW4.7 Filmer base UID: **1.2.840.113619.2.377**

Also note that elements not listed in following modules are not supported.

9.4.1 Common Patient Entity Modules

9.4.1.1 Patient Module

This section specifies the attributes of the Patient that describe and identify the Patient who is the subject of a diagnostic Study. This Module contains attributes of the patient that are needed for diagnostic interpretation of the Image and are common for all studies performed on the patient.

TABLE 9-3 PATIENT MODULE ATTRIBUTES

Attribute Name	Tag	Type	Attribute Description
Patient's Name	(0010,0010)	2	<u>Viewer</u> Original <u>Filmer</u> Patient name of first referenced image if No Mix Mode or Mix Mode = Study User defined if Mix Mode = Patient
Patient ID	(0010,0020)	2	<u>Viewer</u> Original <u>Filmer</u> Patient ID of first referenced image if No Mix Mode or Mix Mode = Study Function of pid and time if Mix Mode = Patient
Issuer of Patient ID	(0010,0021)	3	Not filled
Issuer of Patient ID Qualifiers Sequence	(0010,0024)	3	Not filled
Patient's Birth Date	(0010,0030)	2	<u>Viewer</u> Original <u>Filmer</u> Patient's Birth Date of first referenced image if No Mix Mode or Mix Mode = Study Empty if Mix Mode = Patient
Patient's Birth Time	(0010,0032)	3	<u>Viewer</u> Original if present, empty otherwise <u>Filmer</u> Empty
Patient's Sex	(0010,0040)	2	<u>Viewer</u> Original <u>Filmer</u> Patient's Sex of first referenced image if No Mix Mode or Mix Mode = Study Empty if Mix Mode = Patient
Other Patient IDs	(0010,1000)	3	Not filled
Other Patient Ids Sequence	(0010,1002)	3	Not filled

Ethnic Group	(0010,2160)	3	<u>Viewer</u> Original if present, empty otherwise <u>Filmer</u> Empty
Patient Comments	(0010,4000)	3	<u>Viewer</u> Original if present, empty otherwise <u>Filmer</u> Empty

9.4.2 Common Study Entity Modules

9.4.2.1 General Study Module

This section specifies the Attributes, which describe and identify the Study performed upon the Patient.

TABLE 9-4 GENERAL STUDY MODULE ATTRIBUTES

Attribute Name	Tag	Type	Notes
Study Instance UID	(0020,000D)	1	<u>Viewer</u> Original <u>Filmer</u> Original if No Mix Mode Generated if Mix Mode = Patient or Mix Mode = Study
Study Date	(0008,0020)	2	<u>Viewer</u> Original <u>Filmer</u> Study Date of first referenced image (Empty if does not exist) if No Mix Mode Empty if Mix Mode = Patient or Mix Mode = Study
Study Time	(0008,0030)	2	<u>Viewer</u> Original <u>Filmer</u> Study Time of first referenced image (Empty if does not exist) if No Mix Mode Empty if Mix Mode = Patient or Mix Mode = Study
Accession Number	(0008,0050)	2	<u>Viewer</u> Original <u>Filmer</u> Accession Number of first referenced image (Empty if does not exist) if No Mix Mode Empty if Mix Mode = Patient or Mix Mode = Study

Referring Physician's Name	(0008,0090)	2	<u>Viewer</u> Original <u>Filmer</u> Referring Physician's Name of first referenced image (Empty if does not exist) if No Mix Mode Semantically empty if Mix Mode = Patient or Mix Mode = Study (The content may be empty or contain only ^)
Study Description	(0008,1030)	3	<u>Viewer</u> Original if present, empty otherwise <u>Filmer</u> If No Mix Mode, this is the study Description of first referenced image. It is empty if the original study description is not present. User defined if Mix Mode = Patient or Mix Mode = Study
Study ID	(0020,0010)	2	<u>Viewer</u> Original <u>Filmer</u> Study ID of first referenced image (Empty if does not exist) if No Mix Mode Generated if Mix Mode = Patient or Mix Mode = Study

9.4.2.2 Patient Study Module

This section defines Attributes that provide information about the Patient at the time the Study was performed.

TABLE 9-5 PATIENT STUDY MODULE ATTRIBUTES

Attribute Name	Tag	Type	Attribute Description
Patient's Age	(0010,1010)	3	<u>Viewer</u> Original if present, empty otherwise <u>Filmer</u> Patient's Age of first referenced image if No Mix Mode. It is empty if the original Patient's Age is not present. Empty if Mix Mode = Patient or Mix Mode = Study

Patient's Size	(0010,1020)	3	<u>Viewer</u> Original if present, empty otherwise <u>Filmer</u> Patient's Size of first referenced image if No Mix Mode. It is empty if the original Patient's Size is not present. Empty if Mix Mode = Patient or Mix Mode = Study
Patient's Weight	(0010,1030)	3	<u>Viewer</u> Original if present, empty otherwise <u>Filmer</u> Patient's Weight of first referenced image if No Mix Mode. It is empty if the original Patient's Weight is not present. Empty if Mix Mode = Patient or Mix Mode = Study
Occupation	(0010,2180)	3	<u>Viewer</u> Original if present, empty otherwise <u>Filmer</u> Empty
Additional Patient History	(0010,21B0)	3	<u>Viewer</u> Original if present, empty otherwise <u>Filmer</u> Empty

9.4.3 Key Object Document Series Entity Modules

9.4.3.1 Key Object Document Series Module

This section specifies the attributes that identify and describe general information about the Key Object Document Series within a Study.

TABLE 9-6 KEY OBJECT SELECTION DOCUMENT SERIES MODULE ATTRIBUTES

Attribute Name	Tag	Type	Attribute Description
Modality	(0008,0060)	1	KO
Series Instance UID	(0020,000E)	1	Generated
Series Number	(0020,0011)	1	Generated
Series Description	(0008,103E)	3	<u>Viewer:</u> Key Object description if not empty, Key Object Selection title otherwise. <u>Filmer:</u> Begin with Key Object Selection title, followed by user description (filled by default with "AW Electronic Film")
Series Date	(0008,0021)	3	Not present
Series Time	(0008,0031)	3	Not present

Referenced Performed Procedure Step Sequence	(0008,1111)	2	Empty
--	-------------	---	-------

9.4.4 Common Equipment Entity Modules

9.4.4.1 General Equipment Module

This section specifies the attributes that identify and describe the piece of equipment that produced a Series of Images.

TABLE 9-7 GENERAL EQUIPMENT MODULE ATTRIBUTES

Attribute Name	Tag	Type	Attribute Description
Manufacturer	(0008,0070)	2	GE MEDICAL SYSTEMS
Institution Name	(0008,0080)	3	Hospital Name provided on the platform
Institution Address	(0008,0081)	3	<u>Viewer</u> Original if present, empty otherwise <u>Filmer</u> Empty
Station Name	(0008,1010)	3	Host name provided on the platform
Institutional Department Name	(0008,1040)	3	<u>Viewer</u> Original if present, empty otherwise <u>Filmer</u> Empty
Manufacturer's Model Name	(0008,1090)	3	<u>Viewer:</u> VIEWER_5 <u>Filmer:</u> FILMER_5
Device Serial Number	(0018,1000)	3	Empty
Software Versions	(0018,1020)	3	Software version build identifier

9.4.5 Key Object document Entity Modules

9.4.5.1 Key Object document

This section specifies the attributes that identify and describe the Key Object document.

TABLE 9-8 KEY OBJECT DOCUMENT GENERAL MODULE ATTRIBUTES

Attribute Name	Tag	Type	Attribute Description
Instance Number	(0020, 0013)	1	Generated
Content Date	(0008, 0023)	1	Generated at the date when the Key Object is created
Content Time	(0008, 0033)	1	Generated at the time when the Key Object is created
Referenced Request Sequence	(0040,A370)	1C	N/A
Current Requested Procedure Evidence Sequence	(0040,A375)	1C	List of images referenced within the Key Object Selection.
> Study Instance UID	(0020,000D)	1	Refer to (0040,A375)

> Referenced Series Sequence	(0008,1115)	1	Refer to (0040,A375)
>> Series Instance UID	(0020,000E)	1	Refer to (0040,A375)
>> Referenced SOP Sequence	(0008,1199)	1	Refer to (0040,A375)
>>> Referenced SOP Class UID	(0008,1150)	1	Refer to (0040,A375)
>>> Referenced SOP Instance UID	(0008,1155)	1	Refer to (0040,A375)

9.4.5.2 SR Document Content Module

This section specifies the attributes that identify and describe the SR Document content

TABLE 9-9 SR DOCUMENT CONTENT MODULE ATTRIBUTES

Attribute Name	Tag	Type	Attribute Description
Value Type	(0040, A040)	1	CONTAINER
Concept Name code Sequence	(0040, A043)	1C	Describe Title in DCID(7010) Key Object Selection Document Titles. See 9.5.4 Note: For Filmer, title is forced to “Of Interest” Note: This title is translated into current application language
> Code Value	(0008, 0100)	1C	See (0040, A043) Sequence
> Coding Scheme Designator	(0008, 0102)	1C	See (0040, A043) Sequence
> Code Meaning	(0008, 0104)	1C	See (0040, A043) Sequence
Continuity Of Content	(0040, A050)	1C	SEPARATE
Content Template Sequence	(0040, A504)	1C	Template that describes the content of the content item
> Mapping Resource	(0008, 0105)	1	DCMR
> Template Identifier	(0040, DB00)	1	2010
Observation Date Time	(0040, A032)	1C	Generated at the date and time when the Key Object is created
Content Sequence	(0040, A730)	1C	Content of the DICOM KEY OBJECT SELECTION – See 9.5

GE Healthcare

DIR 5479848-1EN REV 1

9.4.6 General Modules

The SOP Common Module is mandatory for all DICOM IODs.

9.4.6.1 SOP Common Module

This section defines the Attributes that are required for proper functioning and identification of the associated SOP Instances. They do not specify any semantics about the Real-World Object represented by the IOD.

TABLE 9-10 SOP COMMON MODULE ATTRIBUTES

Attribute Name	Tag	Type	Attribute Description
Instance Creation Date	(0008,0012)	3	Date the Key Object was created
Instance Creation Time	(0008,0013)	3	Time the Key Object was created
Instance Creator UID	(0008,0014)	3	Empty
SOP Class UID	(0008,0016)	1	1.2.840.10008.5.1.4.1.1.88.59
SOP Instance UID	(0008,0018)	1	Generated from GE Based UID, <station configuration> and timestamp.
Specific Character Set	(0008,0005)	1C	<p><u>Viewer:</u></p> <ul style="list-style-type: none"> • ISO_IR 100 if original value is not present and at least one of the Dicom data element contains non-ascii characters. • Original value otherwise <p><u>Filmer:</u></p> <ul style="list-style-type: none"> • ISO_IR 100 if Mix Mode = Patient • Otherwise: <ul style="list-style-type: none"> • ISO_IR 100 if original value is not present and at least one of the Dicom data element contains non-ascii characters. • Original value otherwise <p>Note: Multi valued Specific Character Set with first value non-null and Specific Character Set ISO_IR 13 are not supported.</p>
Instance Number	(0020,0013)	3	Equal to 1

9.5 KEY OBJECT SELECTION – TEMPLATE IDENTIFICATION

This section describes the Key Object Selection Template – TID 2010

This template describes how the SR Document Content Module of the Key Object Selection Information Object Definition is constrained. This template is the standard TID 2010.

9.5.1 TID 2010 Key Object Selection

NL	Rel with	VT	Concept Name	VM	Req	Condition	Value Set Constraint
----	----------	----	--------------	----	-----	-----------	----------------------

GE Healthcare

DIR 5479848-1EN REV 1

		Parent			Type			
1			CONTAINER	DCID(7010) Key Object Selection Document Title	1	M	Root node	
2	>	HAS CONCEPT MOD	CODE	EV (113011, DCM, "Document Title Modifier")	1-n	U	Not used	
3	>	HAS CONCEPT MOD	CODE	EV (113011, DCM, "Document Title Modifier")	1	UC	IF Row 1 Concept Name = (113001, DCM, "Rejected for Quality Reasons") or (113010, DCM, "Quality Issue")	DCID (7011)
4	>	HAS CONCEPT MOD	CODE	EV (113011, DCM, "Document Title Modifier")	1	MC	IF Row 1 Concept Name = (113013, DCM, "Best In Set")	DCID (7012)
5	>	HAS CONCEPT MOD	INCLUDE	DTID(1204) Language of Content Item and Descendants	1	U		Not used
6	>	HAS OBS CONTEXT	INCLUDE	DTID(1002) Observer Context	1-n	U		Present
7	>	CONTAINS	TEXT	EV(113012, DCM, "Key Object Description")	1	U		<u>Viewer:</u> User defined. It is not present if description is not filled <u>Filmer:</u> User defined, filled by default with "AW Electronic Film"
8	>	CONTAINS	IMAGE	Purpose of Reference shall not be present	1-n	MC		Present

9.5.2 TID 1002 Observer Context

	NL	Rel with Parent	VT	Concept Name	VM	Req Type	Condition	Value Set Constraint
1		HAS OBS CONTEXT	CODE	EV (121005,DCM, "Observer Type")	1	MC		EV (121006,DCM, "Person")
2		HAS OBS CONTEXT	INCLUDE	DTID (1003) Person observer identifying attributes	1	MC		

9.5.3 TID 1003 Person Observer Identifying Attributes

	NL	Rel with Parent	VT	Concept Name	VM	Req Type	Condition	Value Set Constraint
1			PNAME	EV (121008,DCM, "Person Observer Name")	1	M		Name of the current user
2			TEXT	EV (121009,DCM, " Person Observer's Organization Name")	1	U		Hospital Name provided on the platform

GE Healthcare

DIR 5479848-1EN REV 1

9.5.4 CID 7010 Key Object Selection Document Title

Coding Scheme Designator (0008,0102)	Code Value (0008,0100)	Code Meaning (0008,0104)
DCM	113000	Of Interest
DCM	113001	Rejected for Quality Reasons
DCM	113002	For Referring Provider
DCM	113003	For Surgery
DCM	113004	For Teaching
DCM	113005	For Conference
DCM	113006	For Therapy
DCM	113007	For Patient
DCM	113008	For Peer Review
DCM	113009	For Research
DCM	113010	Quality Issue
DCM	113013	Best In Set
DCM	113018	For Printing
DCM	113020	For Report Attachment
DCM	113030	Manifest
DCM	113031	Signed Manifest
DCM	113032	Complete Study Content
DCM	113033	Signed Complete Study Content
DCM	113034	Complete Acquisition Content
DCM	113035	Signed Complete Acquisition Content
DCM	113036	Group of Frames for Display

9.5.5 CID 7012 Key Object Selection Document Title Modifier

Coding Scheme Designator (0008,0102)	Code Value (0008,0100)	Code Meaning (0008,0104)
DCM	113014	Study
DCM	113015	Series
DCM	113016	Performed Procedure Step
DCM	113017	Stage-View

10. XA IMAGE INFORMATION OBJECT IMPLEMENTATION

10.1 INTRODUCTION

The AW 4.7 2D Multi-Modality Viewer can save all injected frames of a DSA or Bolus multi-frame image (including user annotations and measurements) into a new XA multi-frame image. In case of biplane acquisition, two XA multi-frame images will be saved, corresponding to both frontal and lateral original images. This feature only works on XA GE images.

The aim of the DEVIRED XA images, is it to create substracted images for systems that cannot perform the operation. The subtraction is applied in it and so the object generated can be reviewed on elsewhere without having to apply processing again.

This section specifies the use of the DICOM XA Image IOD to represent the information included in XA image produced by this implementation. Corresponding attributes are conveyed using the module construct. The contents of this section are:

10.2 - XA IMAGE Entity-Relationship Model

10.3 - XA IMAGE-IOD MODULE TABLE

10.4 - XA Image -INFORMATION MODULE DEFINITIONS

10.5 - XA IMAGE-Private data dictionary

10.2 XA IMAGE ENTITY-RELATIONSHIP MODEL

The Entity-Relationship diagram for the XA Image interoperability schema is shown in **Illustration 10.2.1**. In this figure, the following diagrammatic convention is established to represent the information organization:

- Each entity is represented by a rectangular box
- Each relationship is represented by a diamond shaped box.
- The fact that a relationship exists between two entities is depicted by lines connecting the corresponding entity boxes to the relationship boxes.

The relationships are fully defined with the maximum number of possible entities in the relationship shown. In other words, the relationship between Series and Image can have up to n Images per Series, but the Study to Patient relationship has 1 Patient for each Study (a Patient can have more than one Study on the system, however each Study will contain all of the information pertaining to that Patient).

ILLUSTRATION 10.2-1
XA IMAGE IMAGE ENTITY RELATIONSHIP DIAGRAM

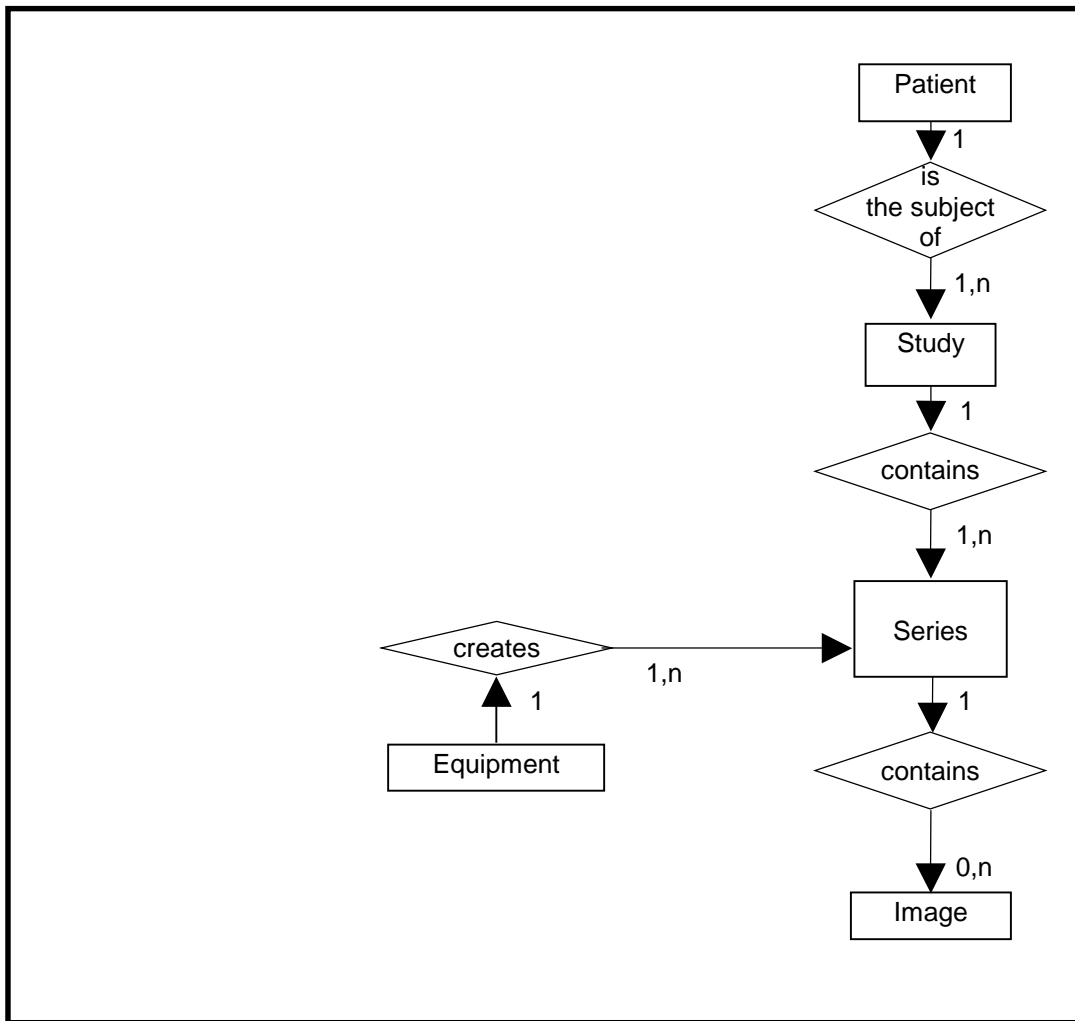

10.2.1 ENTITY DESCRIPTIONS

Please refer to DICOM Standard Part 3 (Information Object Definitions) for a description of each of the entities contained within the XA Image Information Object.

10.2.2 Advantage Workstation 4.7 Mapping of DICOM entities

TABLE 10-1 MAPPING OF DICOM ENTITIES TO ADVANTAGE WORKSTATION 4.7 ENTITIES

DICOM	Advantage Workstation 4.7 Entity
Patient	Patient
Study	Exam
Series	Series
Equipment	Equipment
Image	Image

10.3 XA IMAGE-IOD MODULE TABLE

Within an entity of the DICOM XA Image IOD, attributes are grouped into related set of attributes. A set of related attributes is termed a module. A module facilitates the understanding of the semantics concerning the attributes and how the attributes are related with each other. A module grouping does not infer any encoding of information into datasets.

Table 10.3-1 identifies the defined modules within the entities which comprise the DICOM XA Image IOD. Modules are identified by Module Name.

See DICOM Part 3 for a complete definition of the entities, modules, and attributes.

TABLE 10-2 XA IMAGE DOCUMENT IOD MODULES

Entity Name	Module Name	Reference
Patient	Patient	10.4.1
	Clinical Trial Subject	N/A
Study	General Study	10.4.2.1
	Patient Study	10.4.2.2
	Clinical Trial Study	N/A
Series	General Series	10.4.3
	Clinical Trial Series	N/A
Equipment	General Equipment	10.4.4
Image	General Image	10.4.5.1
	Image Pixels	10.4.5.2
	Contrast/Bolus	10.4.5.3
	Cine	10.4.5.4
	Multi-Frame	10.4.5.5
	Frame Pointers	10.4.5.6
	Display Shutter	N/A
	Device	N/A
	Intervention	N/A
	X-Ray Image	10.4.5.7
	X-Ray Acquisition	10.4.5.8
	X-Ray Collimator	10.4.5.9
	X-Ray Table	10.4.5.10
	XA Positioner	10.4.5.11
	DX Detector	10.4.5.12
Overlay Plane	N/A	
Multi-Frame Overlay	N/A	
Modality LUT	N/A	
VOI LUT	10.4.5.13	
SOP Common	10.4.5.14	
X-Ray Filtration (standard extended)	10.4.5.15	
Mask	N/A	

10.4 XA IMAGE -INFORMATION MODULE DEFINITIONS

Please refer to DICOM Standard Part 3 (Information Object Definitions) for a description of each of the entities and modules contained within the XA Image Information Object.

The following modules are included to convey Enumerated Values, Defined Terms, and Optional Attributes supported. Type 1 & Type 2 Attributes are also included for completeness and to define what values they may take and from where these values are obtained. It should be noted that they are the same ones as defined in the DICOM Standard Part 3 (Information Object Definitions).

The XA Image IOD described here is the one generated by the applications ‘Viewer’ of Advantage Workstation 4.7, based on an original XA image.

In the following chapter, all new study, series and image instance UID are generated from AW 4.7 2D Multi-Modality Viewer base UID: **1.2.840.113619.2.378**

Also note that elements not listed in following modules are ignored and not copied.

10.4.1 Patient Module

This section specifies the attributes of the Patient that describe and identify the Patient who is the subject of a diagnostic Study. This Module contains attributes of the patient that are needed for diagnostic interpretation of the Image and are common for all studies performed on the patient.

TABLE 11.4-1 PATIENT MODULE

Attribute Name	Tag	Type	Attribute Description
Patient's Name	(0010,0010)	2	Copy from original
Patient ID	(0010,0020)	2	Copy from original
Issuer of Patient ID	(0010,0021)	3	Copy from original
Issuer of Patient ID Qualifiers Sequence	(0010,0024)	3	Copy from original
Patient's Birth Date	(0010,0030)	2	Copy from original
Patient's Sex	(0010,0040)	2	Copy from original
Other Patient Ids	(0010,1000)	3	Copy from original
Other Patient Ids Sequence	(0010,1002)	3	Copy from original

10.4.2 Study Modules

10.4.2.1 General Study Module

TABLE 11.4-2 GENRAL STUDY MODULE

Attribute Name	Tag	Type	Attribute Description
Study Instance UID	(0020,000D)	1	Copy from original
Study Date	(0008,0020)	2	Copy from original
Study Time	(0008,0030)	2	Copy from original
Referring Physician's Name	(0008,0090)	2	Copy from original

Study ID	(0020,0010)	2	Copy from original
Accession Number	(0008,0050)	2	Copy from original
Study Description	(0008,1030)	3	Copy from original
Name of Physician(s) Reading Study	(0008,1060)	3	Copy from original
Referenced Study Sequence	(0008,1110)	3	Copy from original if present, not present otherwise
>Referenced SOP Class UID	(0008,1150)	1	Copy from original
>Referenced SOP instance UID	(0008,1155)	1	Copy from original
Procedure Code Sequence	(0008,1032)	3	Copy from original if present, not present otherwise
>Code Value	(0008,0100)	1C	Copy from original
>Coding Scheme Designator	(0008,0102)	1C	Copy from original
>Code Meaning	(0008,0104)	1C	Copy from original

10.4.2.2 Patient Study Module

TABLE 11.4-3 PATIENT STUDY MODULE

Attribute Name	Tag	Type	Attribute Description
Patient's Age	(0010.1010)	3	Copy from original
Patient's Size	(0010,1020)	3	Copy from original
Patient's Weight	(0010,1030)	3	Copy from original
Admission ID	(0038,0010)	3	Copy from original

10.4.3 Series Module

TABLE 11.4-4 SERIES MODULE

Attribute Name	Tag	Type	Attribute Description
Modality	(0008,0060)	1	Copy from original
Series Instance UID	(0020,000E)	1	Generated
Series Number	(0020,0011)	2	Copy from original, in generation mode of one XA processed series per original series Or the value of the DICOM field (0020,0013) 'Instance Number' of the original image, in generation mode of one XA processed series per original image
Performing Physicians' Name	(0008,1050)	3	Copy from original
Protocol Name	(0018,1030)	3	Copy from original, in generation mode of one XA processed series per original series Or

			the value of the DICOM field (0020,4000) 'Image Comments' of the original image, in generation mode of one XA processed series per original image
Series Description	(0008,103E)	3	"Processed:" followed by original series description. Eventually truncated to 64 chars. , in generation mode of one XA processed series per original series Or "Processed: " followed by the value of the DICOM field (0020,4000) 'Image Comments' of the original image, in generation mode of one XA processed series per original image
Operators' Name	(0008,1070)	3	Current user's name
Patient Position	(0018,5100)	3	Copy from original
Request Attributes Sequence	(0040,0275)	3	Copy from original if present, not present otherwise
>Requested Procedure ID	(0040,1001)	1C	Copy from original if present, not present otherwise
>Requested Procedure Description	(0032,1060)	3	Copy from original
>Requested Procedure Code Sequence	(0032,1064)	3	Copy from original if present, not present otherwise
>>Code Value	(0008,0100)	1C	Copy from original
>>Coding Scheme Designator	(0008,0102)	1C	Copy from original
>>Code Meaning	(0008,0104)	1C	Copy from original
>Scheduled Procedure Step ID	(0040,0009)	1C	Copy from original if present, not present otherwise
>Scheduled Procedure Step Description	(0040,0007)	3	Copy from original
>Scheduled Protocol Code Sequence	(0040,0008)	3	Copy from original if present, not present otherwise
>>Code Value	(0008,0100)	1C	Copy from original
>>Coding Scheme Designator	(0008,0102)	1C	Copy from original
>>Code Meaning	(0008,0104)	1C	Copy from original

10.4.4 Equipment Module

The following Equipment IE Module is common to all Composite Image IODs that reference the Equipment IE.

TABLE 11.4-4 EQUIPMENT MODULE

Attribute Name	Tag	Type	Attribute Description
Manufacturer	(0008,0070)	2	Copy from original

Institution Name	(0008,0080)	3	Copy from original
Institution Address	(0008,0081)	3	Copy from original
Station Name	(0008,1010)	3	Copy from original
Manufacturer's Model Name	(0008,1090)	3	Copy from original
Device Serial Number	(0018,1000)	3	Copy from original
Software versions	(0018,1020)	3	Copy from original

10.4.5 Image Modules

This section specifies the Attributes that describe the Image Entity Modules.

10.4.5.1 General Image Module

TABLE 11.4-5 GENERAL IMAGE MODULE

Attribute Name	Tag	Type	Attribute Description
Instance Number	(0020,0013)	2	Copy from original
Patient Orientation	(0020,0020)	2C	Copy from original if same number of frames than original, calculated otherwise
Content Date	(0008,0023)	2C	Copy from original
Content Time	(0008,0033)	2C	Copy from original
Image Type	(0008,0008)	3	"DERIVED\SECONDARY\SINGLE PLANE" or "DERIVED\SECONDARY\BIPLANE A" or "DERIVED\SECONDARY\BIPLANE B" Eventually followed by: - "DISTORTION FREE", if the fourth field of original image is equal to "DISTORTION FREE", - "IMAGE PASTING", if the fourth field of original image is equal to "IMAGE PASTING"
Acquisition Date	(0008,0022)	3	Copy from original
Acquisition Time	(0008,0032)	3	Copy from original
Referenced Image Sequence	(0008,1140)	3	Not present in case of single plane
>Referenced SOP class UID	(0008,1150)	1C	SOP Class UID of the derived other plane of a biplane pair

>Referenced SOP instance UID	(0008,1155)	1C	Instance UID of the derived other plane of a biplane pair
>Purpose of Referenced Code Sequence	(0040,A170)	3	Generated
>>Code Value	(0008,0100)	1C	"121314"
>>Coding Scheme Designator	(0008,0102)	1C	"DCM"
>>Code meaning	(0008,0104)	1C	"Other image of biplane pair"
Source Image Sequence	(0008,2112)	3	Generated
>Referenced SOP class UID	(0008,1150)	1C	SOP class UID of the original XA image
>Referenced SOP instance UID	(0008,1155)	1C	Instance UID of the original XA image
> Referenced Frame Number	(0008,1160)	1C	Not present
Image Comments	(0020,4000)	3	Copy from original
Burned In Annotation	(0028,0301)	3	Copy from original
Lossy Image Compression	(0028,2110)	3	Copy from original

10.4.5.2 Image Pixels Module

TABLE 11.4-6 IMAGE PIXELS MODULE

Attribute Name	Tag	Type	Attribute Description
Samples per Pixel	(0028,0002)	1	Copy from original
Photometric Interpretation	(0028,0004)	1	Copy from original
Rows	(0028,0010)	1	Copy from original
Columns	(0028,0011)	1	Copy from original
Bits Allocated	(0028,0100)	1	Copy from original
Bits Stored	(0028,0101)	1	Copy from original
High Bit	(0028,0102)	1	Copy from original
Pixel Representation	(0028,0103)	1	Copy from original
Pixel Data	(7FE0,0010)	1	Derived from original pixel data

10.4.5.3 Contrast Bolus Module

This module is not present in generated image if it is not present in original one.

TABLE 11.4-7 CONTRAST BOLUS MODULE

Attribute Name	Tag	Type	Attribute Description
Contrast/Bolus Agent	(0018,0010)	2	Copy from original

10.4.5.4 Cine Module

This module is not present in generated image if it is not present in original one.

TABLE 11.4-8 CINE MODULE

Attribute Name	Tag	Type	Attribute Description
Frame Time	(0018,1063)	1C	Copy from original if present, not present otherwise
Frame Time Vector	(0018,1065)	1C	If present in original image: - Copy from original if same number of frames than original, - subset of original otherwise If not present in original image: Not Present
Start Trim	(0008,2142)	3	Copy from original if same number of frames than original, set to 1 otherwise
Stop Trim	(0008,2143)	3	Copy from original if same number of frames than original, set to number of frames (0028,0008) otherwise
Recommended Display Frame Rate	(0008,2144)	3	Copy from original
Cine Rate	(0018,0040)	3	Copy from original
Frame Delay	(0018,1066)	3	Copy from original if same number of frames than original, based on original otherwise

10.4.5.5 Multi Frame Module

TABLE 11.4-9 MULTI-FRAME MODULE

Attribute Name	Tag	Type	Attribute Description
Number Of Frames	(0028,0008)	1C	Set to number of opacified images, otherwise copy of original (if no mask)
Frame Increment Pointer	(0028,0009)	1C	Copy from original Note: if number of frames different than original, and if Frame Increment Pointer is (0018,1063), keep pointer to (0018,1063) Frame Time value.

10.4.5.6 Frame Pointers Module

TABLE 11.4-10 FRAME POINTERS MODULE

Attribute Name	Tag	Type	Attribute Description
----------------	-----	------	-----------------------

Representative Frame Number	(0028,6010)	3	Copy from original if same number of frames than original, (new value = old value - first opacified frame number) otherwise
-----------------------------	-------------	---	--

10.4.5.7 X-Ray Image Module

TABLE 11.4-11 X-RAY IMAGE MODULE

Attribute Name	Tag	Type	Attribute Description
Frame Increment Pointer	(0028,0009)	1C	Copy from original
Lossy Image Compression	(0028,2110)	1C	Copy from original
Image Type	(0008,0008)	3	"DERIVED\SECONDARY\SINGLE PLANE" or "DERIVED\SECONDARY\BIPLANE A" or "DERIVED\SECONDARY\BIPLANE B" Eventually followed by: - "DISTORTION FREE", if the fourth field of original image is equal to "DISTORTION FREE", - "IMAGE PASTING", if the fourth field of original image is equal to "IMAGE PASTING"
Pixel Intensity Relationship	(0028,1040)	1	"DISP"
Samples per Pixel	(0028,0002)	1	Copy from original
Photometric Interpretation	(0028,0004)	1	Copy from original
Bits Allocated	(0028,0100)	1	Copy from original
Bits Stored	(0028,0101)	1	Copy from original
High Bit	(0028,0102)	1	Copy from original
Pixel Representation	(0028,0103)	1	Copy from original
Scan Options	(0018,0022)	3	Copy from original
Referenced Image Sequence	(0008,1140)	1C	Not present in case of single plane
>Referenced SOP class UID	(0008,1150)	1C	SOP Class UID of the derived other plane of a biplane pair
>Referenced SOP instance UID	(0008,1155)	1C	Instance UID of the derived other plane of a biplane pair
>Purpose of Referenced Code Sequence	(0040,A170)	3	See below

>>Code Value	(0008,0100)	1C	"121314"
>>Coding Scheme Designator	(0008,0102)	1C	"DCM"
>>Code meaning	(0008,0104)	1C	"Other image of biplane pair"
Calibration Image	(0050,0004)	3	Copy from original

10.4.5.8 X-Ray Acquisition Module

TABLE 11.4-12 X-RAY ACQUISITION MODULE

Attribute Name	Tag	Type	Attribute Description
KVP	(0018,0060)	2	Copy from original
Radiation Setting	(0018,1155)	1	Copy from original
X-Ray Tube Current	(0018,1151)	2C	Copy from original
Exposure Time	(0018,1150)	2C	Copy from original
Exposure	(0018,1152)	2C	Copy from original
Grid	(0018,1166)	3	Copy from original
Average Pulse Width	(0018,1154)	3	Copy from original
Radiation Mode	(0018,115A)	3	Copy from original
Intensifier Size	(0018,1162)	3	Copy from original
Field of View Shape	(0018,1147)	3	Copy from original
Field of View Dimension(s)	(0018,1149)	3	Copy from original
Focal Spot	(0018,1190)	3	Copy from original
Image and Fluoroscopy Area Dose Product	(0018,115E)	3	Copy from original

10.4.5.9 X-Ray Collimator Module

This module is not present in generated image if it is not present in original one.

TABLE 11.4-13 X-RAY COLLIMATOR MODULE

Attribute Name	Tag	Type	Attribute Description
Collimator Shape	(0018,1700)	1	Copy from original
Collimator Left Vertical Edge	(0018,1702)	1C	Copy from original
Collimator Right Vertical Edge	(0018,1704)	1C	Copy from original
Collimator Upper Horizontal Edge	(0018,1706)	1C	Copy from original
Collimator Lower Horizontal Edge	(0018,1708)	1C	Copy from original

10.4.5.10 X-Ray Table Module

This module is not present in generated image if it is not present in original one.

TABLE 11.4-14 X-RAY TABLE MODULE

Attribute Name	Tag	Type	Attribute Description
Table Motion	(0018,1134)	2	Copy from original
Table Vertical Increment	(0018,1135)	2C	Copy from original if same number of frames than original, based on original otherwise
Table Longitudinal Increment	(0018,1137)	2C	Copy from original if same number of frames than original, based on original otherwise
Table Lateral Increment	(0018,1136)	2C	Copy from original if same number of frames than original, based on original otherwise
Table Angle	(0018,1138)	3	Copy from original

10.4.5.11 XA Positioner Module

TABLE 11.4-15 XA POSITIONER MODULE

Attribute Name	Tag	Type	Attribute Description
Distance Source To Patient	(0018,1111)	3	Copy from original if same number of frames than original, based on original otherwise
Distance Source To Detector	(0018,1110)	3	Copy from original if same number of frames than original, based on original otherwise
Estimated Radiographic Magnification Factor	(0018,1114)	3	Copy from original
Positioner Motion	(0018,1500)	2C	Copy from original
Positioner Primary Angle	(0018,1510)	2	Copy from original if same number of frames than original, based on original otherwise
Positioner Secondary Angle	(0018,1511)	2	Copy from original if same number of frames than original, based on original otherwise
Positioner Primary Angle Increment	(0018,1520)	2C	If present in original image: <ul style="list-style-type: none"> - Copy from original if same number of frames than original, - based on original otherwise If not present in original image: Not Present
Positioner Secondary Angle Increment	(0018,1521)	2C	If present in original image: <ul style="list-style-type: none"> - Copy from original if same number of frames than original,

			- based on original otherwise If not present in original image: Not Present
--	--	--	---

10.4.5.12 DX Detector Module

This module is not present in generated image if it is not present in original one.

TABLE 11.4-16 DX DETECTOR MODULE

Attribute Name	Tag	Type	Attribute Description
Detector Type	(0018,7004)	2	Copy from original
Field of View Shape	(0018,1147)	3	Copy from original
Field of View Dimension(s)	(0018,1149)	3	Copy from original
Field of View Origin	(0018,7030)	1C	Copy from original if present, not present otherwise
Field of View Rotation	(0018,7032)	1C	Copy from original if present, not present otherwise
Field of View Horizontal Flip	(0018,7034)	1C	Copy from original if present, not present otherwise
Imager Pixel Spacing	(0018,1164)	3	Copy from original

10.4.5.13 VOI Lut Module

TABLE 11.4-17 VOI LUT MODULE

Attribute Name	Tag	Type	Attribute Description
Window Center	(0028,1050)	3	current one
Window Width	(0028,1051)	3	current one

10.4.5.14 SOP Common Module

TABLE 11.4-18 SOP COMMON MODULE

Attribute Name	Tag	Type	Attribute Description
Sop Class UID	(0008,0016)	1	XA SOP class UID
Sop Instance UID	(0008,0018)	1	Generated
Specific Character Set	(0008,0005)	1C	Copy from original
Instance Number	(0020,0013)	2	Copy from original

10.4.5.15 X-Ray Filtration Module (standard extended)

TABLE 11.4-19 X-RAY FILTRATION MODULE

Attribute Name	Tag	Type	Attribute Description
Filter Type	(0018,1160)	3	Copy from original

10.5 XA IMAGE-PRIVATE DATA DICTIONARY

This section describes the private attributes of this IOD.

Table 10.5-1 PRIVATE CREATOR IDENTIFICATION: DLX_SERIE_01

Attribute Name	Tag	VR	VM	Type
adx acq mode	(0019,xx14)	IS	1	3
ip address	(0019,xx20)	LO	1	3
Lambda cm pincushion distortion	(0019,xx24)	DS	1	3
Slope LV regression	(0019,xx25)	DS	1	3
Intercept LV regression	(0019,xx26)	DS	1	3
table vertical position	(0019,xx21)	DS	1	3
table longitudinal position	(0019,xx22)	DS	1	3
table lateral position	(0019,xx23)	DS	1	3
angle value 1	(0019,xx01)	DS	1	3
angle value 2	(0019,xx02)	DS	1	3
angle value 3	(0019,xx03)	DS	1	3
user spatial filter strength	(0019,xx17)	IS	1	3

Table 10.5-2 PRIVATE CREATOR IDENTIFICATION: GEMS_DL_IMG_01

Attribute Name	Tag	VR	VM	Type
patient orientation vector	(0019,xxBF)	CS	2-2N	3
patient position per image	(0019,xxC7)	CS	1	3
Acquisition plane	(0019,xxDE)	CS	1	3
contrast bolus ingredient relative absorption	(0019,xxE0)	FL	1	3
auto injection enabled	(0019,xxA4)	CS	1	3
injection phase	(0019,xxA5)	CS	1	3
injection delay	(0019,xxA6)	DS	1	3
reference injection frame number	(0019,xxA7)	IS	1	3
recommended display frame rate float	(0019,xxB8)	FL	1	3
fov dimension double	(0019,xx0B)	DS	1-2	3
Distance Object to Table Top	(0019,xx2B)	FL	1	3
detector gain	(0019,xx34)	DS	1	3
image detector rotation angle	(0019,xx92)	DS	1	3
image flip	(0019,xx95)	CS	2	3
can downscan 512	(0019,xxAA)	CS	1	3
Acquisition Mode Description	(0019,xxB1)	LO	1	3
Acquisition Mode Display Label	(0019,xxB2)	LO	1	3
Acquisition Protocol User Name	(0019,xxB3)	LO	1	3
Acquisition Region	(0019,xxBA)	CS	1	3
Acquisition SUB mode	(0019,xxBB)	CS	1	3

preselected pivot rotation speed	(0019,xxC5)	FL	1	3
detection gain value	(0019,xxD4)	FL	1	3
mR mAs calibration value	(0019,xxD5)	FL	1	3
DRM LUT file name	(0019,xxDC)	LO	1	3
DRM Strength	(0019,xxDD)	DS	1-N	3
Table Tilt Angle First frame	(0019,xxEE)	FL	1	3
table rotation angle	(0019,xxEA)	FL	1	3
table cradle angle	(0019,xxBC)	FL	1	3
table rotation status vector	(0019,xxBD)	CS	1-N	3
table rotation angle increment	(0019,xxC3)	FL	1-N	3
Table X Position to Isocenter	(0019,xxEB)	FL	1	3
Table Y Position to Isocenter	(0019,xxEC)	FL	1	3
Table Z Position to Isocenter	(0019,xxED)	FL	1	3
Table X Position to Isocenter increment	(0019,xxD7)	FL	1-N	3
Table Y Position to Isocenter increment	(0019,xxD8)	FL	1-N	3
Table Z Position to Isocenter increment	(0019,xxD9)	FL	1-N	3
Table Head Tilt Angle increment	(0019,xxDA)	FL	1-N	3
Table Cradle Tilt Angle increment	(0019,xxDB)	FL	1-N	3
angle 1 increment	(0019,xx97)	DS	1-N	3
angle 2 increment	(0019,xx98)	DS	1-N	3
angle 3 increment	(0019,xx99)	DS	1-N	3
SID vector	(0019,xxBE)	FL	1-N	3
SOD vector	(0019,xxE9)	FL	1-N	3
spectral filter thickness	(0019,xxC4)	IS	1	3
default spatial filter family	(0019,xx31)	IS	1	3
default spatial filter strength	(0019,xx32)	IS	1	3
current spatial filter strength	(0019,xxAB)	IS	1	3
applicable review mode	(0019,xx9D)	CS	1	3
log lut control points	(0019,xx9E)	DS	1-N	3
exp lut SUB control points	(0019,xx9F)	DS	1-N	3
ABD value	(0019,xxA0)	DS	1	3
sub window center	(0019,xxA1)	DS	1	3
sub window width	(0019,xxA2)	DS	1	3
exp lut NOSUB control points	(0019,xxAD)	DS	1-N	3
SUB operator LUTs names	(0019,xxAE)	LO	1-N	3
current spatial filter strength	(0019,xxAB)	IS	1	3

Table 10.5-3 PRIVATE CREATOR IDENTIFICATION: GEMS_DL_STUDY_01

Attribute Name	Tag	VR	VM	Type
study dose	(0015,xx80)	DS	1	3

study total dap	(0015,xx81)	DS	1	3
study fluoro dap	(0015,xx82)	DS	1	3
study fluoro time	(0015,xx83)	IS	1	3
study record dap	(0015,xx84)	DS	1	3
study record time	(0015,xx85)	IS	1	3
Study dose Frontal	(0015,xx92)	FL	1	3
Study total dap Frontal	(0015,xx93)	FL	1	3
study fluoro dap frontal	(0015,xx94)	FL	1	3
study fluoro time frontal	(0015,xx95)	IS	1	3
study record dap frontal	(0015,xx96)	FL	1	3
study record time frontal	(0015,xx97)	IS	1	3
study dose lateral	(0015,xx98)	FL	1	3
study total dap lateral	(0015,xx99)	FL	1	3
study fluoro dap lateral	(0015,xx9A)	FL	1	3
study fluoro time lateral	(0015,xx9B)	IS	1	3
study record dap lateral	(0015,xx9C)	FL	1	3
study record time lateral	(0015,xx9D)	IS	1	3

Table 10.5-4 PRIVATE CREATOR IDENTIFICATION: GEMS_FUNCTOOL_01

Attribute Name	Tag	VR	VM	Type
Bias	(0051,xx03)	SL	1	3
Scale	(0051,xx04)	FL	1	3

Table 10.5-5 PRIVATE CREATOR IDENTIFICATION: GEMS_IDEN_01

Attribute Name	Tag	VR	VM	Type
Full Fidelity	(0009,xx01)	LO	1	3
Suite id	(0009,xx02)	SH	1	3
Product ID	(0009,xx04)	SH	1	3
Image actual date	(0009,xx27)	SL	1	3
Unique Service ID from config file	(0009,xx30)	SH	1	3
Mobile Location Number	(0009,xx31)	SH	1	3
Equipment UID	(0009,xxE3)	UI	1	3
Genesis version - now - 09	(0009,xxE6)	SH	1	3
Exam record checksum	(0009,xxE7)	UL	1	3
Series suite id	(0009,xxE8)	SH	1	3
Actual series data time stamp	(0009,xxE9)	SL	1	3

Table 10.5-6 PRIVATE CREATOR IDENTIFICATION: GEMS_IMPS_01

Attribute Name	Tag	VR	VM	Type
Version of the hdr struct	(0029,xx26)	SS	1	3
Advantage comp. Overflow	(0029,xx34)	SL	1	3
Advantage comp. Underflow	(0029,xx35)	SL	1	3

Table 10.5-7 PRIVATE CREATOR IDENTIFICATION: GEMS_PARM_01

Attribute Name	Tag	VR	VM	Type
Decon kernel parameters	(0043,xx13)	SS	5	3

Table 10.5-8 PRIVATE CREATOR IDENTIFICATION: GEMS_RELA_01

Attribute Name	Tag	VR	VM	Type
Series from which Prescribed	(0021,xx03)	SS	1	3
Genesis version - now - 21	(0021,xx05)	SH	1	3
Series record checksum	(0021,xx07)	UL	1	3
Screen Format	(0021,xx37)	SS	1	3

Table 10.5-9 PRIVATE CREATOR IDENTIFICATION: GEMS_SERS_01

Attribute Name	Tag	VR	VM	Type
Images in Series	(0025,xx07)	SL	1	3
Last image number used	(0025,xx19)	SL	1	3
Primary Receiver Suite and Host	(0025,xx1A)	SH	1	3

11. PRIVATE OBJECT INFORMATION OBJECT IMPLEMENTATION

11.1 INTRODUCTION

AW4.7 supports the following DICOM Private Objects:

- GE Private 3D Model Objects, described in the AW VXTL DCS, see 1.6 - References
- GE private DICOM NM images, described in the GENIE DCS, see 1.6 - References
- GE private DICOM PET images, described in the ADV DCS, see 1.6 - References

12. XA DOWNSCAN INFORMATION OBJECT IMPLEMENTATION

12.1 INTRODUCTION

This section specifies the modifications of XA images produced by this implementation during the *downscan* processing. This processing consists in modifying an existing GE XA 8bit image to reduce the resolution of an X-Ray 8bit image to 512x512.

12.2 XA ENTITY-RELATIONSHIP MODEL

The Entity-Relationship diagram for the XA Image interoperability schema is shown in **Illustration 12.2.1**. In this figure, the following diagrammatic convention is established to represent the information organization:

- Each entity is represented by a rectangular box
- Each relationship is represented by a diamond shaped box.
- The fact that a relationship exists between two entities is depicted by lines connecting the corresponding entity boxes to the relationship boxes.

The relationships are fully defined with the maximum number of possible entities in the relationship shown. In other words, the relationship between Series and Image can have up to n Images per Series, but the Patient to Study relationship has 1 Study for each Patient (a Patient can have more than one Study on the system, however each Study will contain all of the information pertaining to that Patient).

ILLUSTRATION 12.2-1
XA IMAGE ENTITY RELATIONSHIP DIAGRAM

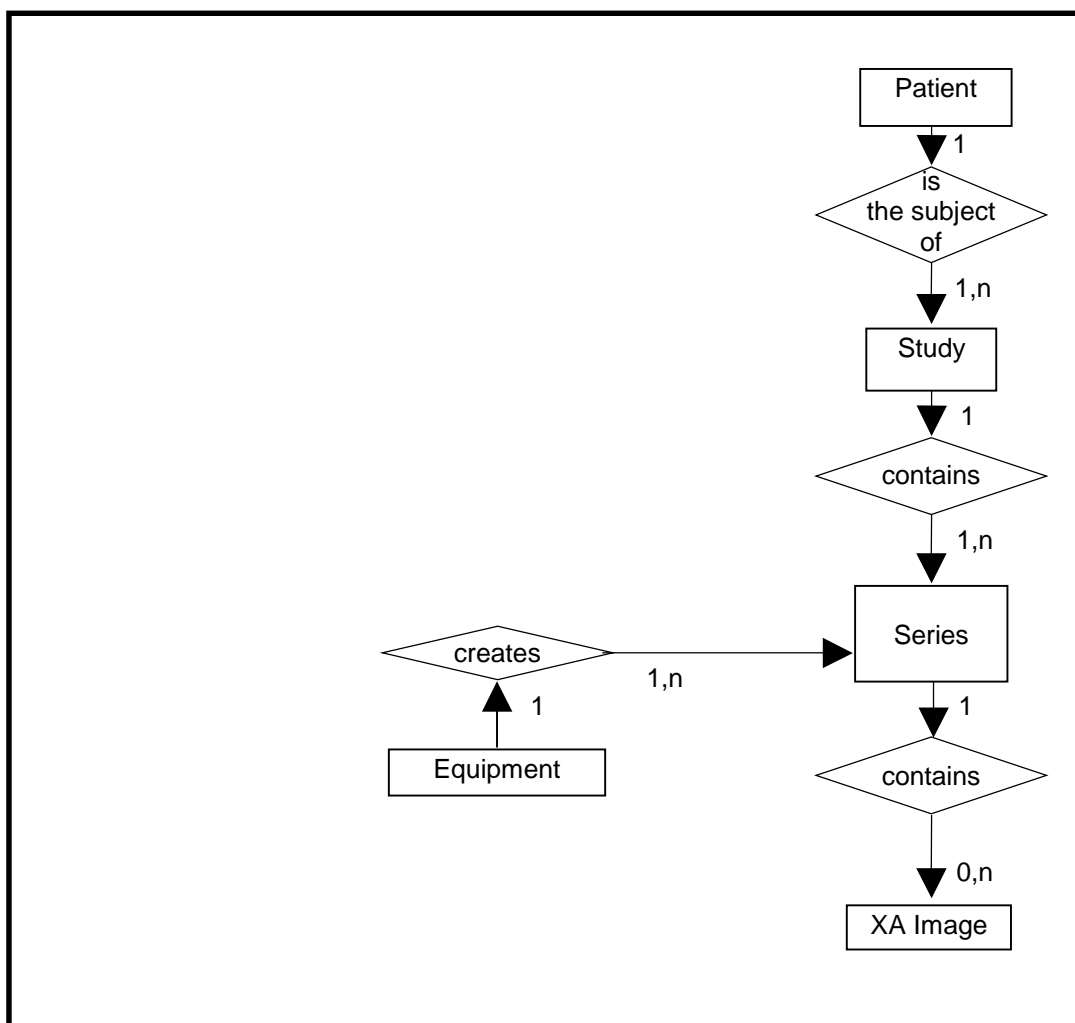

12.2.1 Entity Descriptions

Please refer to DICOM Standard Part 3 (Information Object Definitions) for a full description of each of the entities contained within the XA Information Object.

12.2.2 Advantage Workstation 4.7 Mapping of DICOM entities

TABLE 12-1
MAPPING OF DICOM ENTITIES TO ADVANTAGE WORKSTATION 4.7 ENTITIES

DICOM	Advantage Workstation 4.7 Entity
Patient	Patient
Study	Exam
Series	Series
Image	Image

12.3 XA- DOWNSCAN IOD

The conditions to apply the downscan processing are indicated in 3.4.1.1.2.

The modifications that are done to the XA image during the downscan processing are listed in the following tables, the other fields are copied as is, no IOD module explicitly defined for those fields.

TABLE 12-2
 XA DOWNSCAN IMAGE DOCUMENT IOD MODULES

Entity Name	Module Name	Reference
Patient	Patient Information	12.3.1
Study	General Study	12.3.2.1
	Patient Study	12.3.2.2
Series	General Series	12.3.3
Image	Image Pixels	12.3.4
	Display Shutter	12.3.10
	X-Ray Acquisition	12.3.7
	X-Ray Collimator	12.3.9
	DX Detector	12.3.8
	SOP Common	12.3.5
	Frame Pixel Shift Macro	12.3.6
	Private Module for GEMS_DL_IMG_01	12.3.11
	Private Module for DLX_SERIE_01	12.3.12
	Private Module for GEMS_DL_FRAME_01	12.3.13

12.3.1 Patient Module

Attribute Name	Tag	VR	VM	Downscan image description
Patient's Name	(0010,0010)	PN	1	Copied
Patient ID	(0010,0020)	LO	1	Copied
Issuer of Patient ID	(0010,0021)	LO	1	Not filled
Issuer of Patient ID Qualifiers Sequence	(0010,0024)	SQ	1	Not filled
Patient's Birth Date	(0010,0030)	DA	1	Copied
Patient's Birth Time	(0010,0032)	T M	1	Copied
Patient's Sex	(0010,0040)	CS	1	Copied
Other Patient IDs	(0010,1000)	LO	1-N	Copied

12.3.2 Common Study Entity Modules

12.3.2.1 General Study Module

Attribute Name	Tag	VR	VM	Downscan image description
Study Instance UID	(0020,000D)	UI	1	Copied
Study Date	(0008,0020)	DA	1	Copied
Study Time	(0008,0030)	T M	1	Copied
Accession Number	(0008,0050)	SH	1	Copied
Referring Physician's Name	(0008,0090)	PN	1	Copied
Study Description	(0008,1030)	LO	1	Copied
Study ID	(0020,0010)	SH	1	Copied

GE Healthcare

DIR 5479848-1EN REV 1

12.3.2.2 Patient Study Module

Attribute Name	Tag	VR	VM	Downscan image description
Patient's Age	(0010,1010)	AS	1	Copied
Patient's Size	(0010,1020)	DS	1	Copied
Patient's Weight	(0010,1030)	DS	1	Copied
Admission ID	(0038,0010)	LO	1	Copied

12.3.3 General Series Module

Attribute Name	Tag	VR	VM	Downscan image description
Referenced Performed Procedure Step Sequence	(0008,1111)	SQ	1	Removed
Series Instance UID	(0020,000E)	UI	1	Generated with root UID: 1.2.840.113619.2.350
Performed Procedure Step ID	(0040,0253)	SH	1	Removed
Performed Procedure Step Start Date	(0040,0244)	DA	1	Removed
Performed Procedure Step Start Time	(0040,0245)	TM	1	Removed
Performed Procedure Step Description	(0040,0254)	LO	1	Removed
Performed Protocol Code Sequence	(0040,0260)	SQ	1	Removed

12.3.4 Image Pixels Module

Attribute Name	Tag	VR	VM	Downscan image description
Rows	(0028,0010)	IS	1	512
Columns	(0028,0011)	IS	1	512
Pixel Length	(7FE0,0000)	LO	1	This group length depends of the transfer syntax and of the length of the pixel data
Pixel Data	(7FE0,0010)	OB	1	Updated to match new size of 512x512

12.3.5 SOP Common Module

Attribute Name	Tag	VR	VM	Downscan image description
SOP Instance UID	(0008,0018)	UI	1	Copied from 0019, xx29, GEMS_DL_IMG_01 or Generated with root UID: 1.2.840.113619.2.350

12.3.6 Frame Pixel Shift Macro Module

Attribute Name	Tag	VR	VM	Downscan image description
Mask Sub-pixel Shift	(0028,6114)	FL	2	Updated to match new size of 512x512 Note: This attribute is found in an item of the Mask Substraction sequence (0028,6100).

12.3.7 X-RAY Acquisition Module

Attribute Name	Tag	VR	VM	Downscan image description
FOV Dimension(s)	(0018,1149)	IS	2	No change (both Horizontal and Vertical dimensions)
Imager Pixel Spacing	(0018,1164)	DS	2	Updated to match new size of 512x512

12.3.8 DX Detector Module

Attribute Name	Tag	VR	VM	Downscan image description
FOV Origin	(0018,7030)	DS	2	Updated to match new size of 512x512

12.3.9 X-RAY Collimator Module

Attribute Name	Tag	VR	VM	Downscan image description
----------------	-----	----	----	----------------------------

GE Healthcare

DIR 5479848-1EN REV 1

Attribute Name	Tag	VR	VM	Downscan image description
Collimator Left Vertical Edge	(0018,1702)	IS	1	Updated to match new size of 512x512
Collimator Right Vertical Edge	(0018,1704)	IS	1	Updated to match new size of 512x512
Collimator Upper Horizontal Edge	(0018,1706)	IS	1	Updated to match new size of 512x512
Collimator Lower Horizontal Edge	(0018,1708)	IS	1	Updated to match new size of 512x512
Center of Circular Collimator	(0018,1710)	IS	2	Updated to match new size of 512x512
Radius of Circular Collimator	(0018,1712)	IS	1	Updated to match new size of 512x512
Vertices of the Polygonal Collimator	(0018,1720)	IS	2-2n	Updated to match new size of 512x512

12.3.10 Display Shutter Macro Module

Attribute Name	Tag	VR	VM	Downscan image description
Shutter Left Vertical Edge	(0018,1602)	IS	1	Updated to match new size of 512x512
Shutter Right Vertical Edge	(0018,1604)	IS	1	Updated to match new size of 512x512
Shutter Upper Horizontal Edge	(0018,1606)	IS	1	Updated to match new size of 512x512
Shutter Lower Horizontal Edge	(0018,1608)	IS	1	Updated to match new size of 512x512
Center of Circular Shutter	(0018,1610)	IS	2	Updated to match new size of 512x512 Note: This attribute is not present in actual DL images, see Notes for DL images.
Radius of Circular Shutter	(0018,1612)	IS	1	Updated to match new size of 512x512 Note: This attribute is not present in actual DL images, see Notes for DL images.
Vertices of the Polygonal Shutter	(0018,1620)	IS	2-2n	Updated to match new size of 512x512 Note: This attribute is not present in actual DL images, see Notes for DL images.

Note: An image is DL image if Manufacturer (0008,0070) is “GE MEDICAL SYSTEMS” and the Manufacturer’s Model Name (0008,1090) is “DL”

12.3.11 Private Module for GEMS_DL_IMG_01

Attribute Name	Tag	Private Creator	VR	VM	Downscan image description
Calibration Factor	(0019,xx84)	GEMS_DL_IMG_01	FL	1	Removed
Calibration Accuracy	(0019,xx87)	GEMS_DL_IMG_01	US	1	Removed
Calibration Points Row	(0019,xx8C)	GEMS_DL_IMG_01	US	1-n	Removed
Calibration Points Column	(0019,xx8D)	GEMS_DL_IMG_01	US	1-n	Removed
Can Dowsncan 512	(0019,xxAA)	GEMS_DL_IMG_01	CS	1	NO
fov_dim_double	(0019,xx0B)	GEMS_DL_IMG_01	DS	2	No change (both Horizontal and Vertical dimensions)
Detector Origin	(0019,xx4B)	GEMS_DL_IMG_01	IS	2	Updated to match new size of 512x512

12.3.12 Private Module for DLX_SERIE_01

Attribute Name	Tag	Private Creator	VR	VM	Downscan image description
X Zoom	(0019,xx19)	DLX_SERIE_01	IS	1	Updated to match new size of 512x512
Y Zoom	(0019,xx1A)	DLX_SERIE_01	IS	1	Updated to match new size of 512x512

12.3.13 Private Module for GEMS_DL_FRAME_01

Attribute Name	Tag	Private Creator	VR	VM	Downscan image description
FOV Origin	(0025,xx33)	GEMS_DL_FRAME_01	IS	2	Updated to match new size of 512x512 Note: This attribute is found in an item of the frame_sequence sequence (0025,xx0A,GEMS_DL_FRAME_01).

Attribute Name	Tag	Private Creator	VR	VM	Downscan image description
FOV Dimensions	(0025,xx30)	GEMS_DL_FRAME_0 1	IS	2	No change (both Horizontal and Vertical dimensions) Note: This attribute is found in an item of the frame_sequence sequence (0025,xx0A,GEMS_DL_FRAME_01).
Collimator Left Vertical Edge	(0025,xx34)	GEMS_DL_FRAME_0 1	IS	1	Updated to match new size of 512x512 Note: This attribute is found in an item of the frame_sequence sequence (0025,xx0A,GEMS_DL_FRAME_01).
Collimator Right Vertical Edge	(0025,xx35)	GEMS_DL_FRAME_0 1	IS	1	Updated to match new size of 512x512 Note: This attribute is found in an item of the frame_sequence sequence (0025,xx0A,GEMS_DL_FRAME_01).
Collimator Upper Horizontal Edge	(0025,xx36)	GEMS_DL_FRAME_0 1	IS	1	Note: This attribute is found in an item of the frame_sequence sequence (0025,xx0A,GEMS_DL_FRAME_01). Updated to match new size of 512x512
Collimator Lower Horizontal Edge	(0025,xx37)	GEMS_DL_FRAME_0 1	IS	1	Note: This attribute is found in an item of the frame_sequence sequence (0025,xx0A,GEMS_DL_FRAME_01). Updated to match new size of 512x512
Vertices of the Polygonal Collimator	(0025,xx38)	GEMS_DL_FRAME_0 1	IS	2-2n	Note: This attribute is found in an item of the frame_sequence sequence (0025,xx0A,GEMS_DL_FRAME_01). Updated to match new size of 512x512

12.4 IMPLEMENTATION IDENTIFYING INFORMATION

The Implementation UID for this DICOM downscan implementation is:

AW Downscan Implementation UID	1.2.840.113619.2.350
---------------------------------------	-----------------------------

13. TOOL TO MODIFY FIRST AND LAST NAME OF PATIENTS

13.1 INTRODUCTION

This section describes the use of the tool that enables to modify the first and last name of the selected study. This tool is available on AW4.7. This implementation is intended to create new DICOM images from original DICOM images by removing and modifying specific elements that will be listed in 13.3.

13.2 DESCRIPTION

This implementation is conformant to the Basic Application Level Confidentiality Profile as a de-identifier (described in DICOM PS 3.15 – Annex E) but this conformance does not guarantee a complete de-identification of the generated objects.

The user is invited to check that the created DICOM objects are conformant to local regulations and hospital regulations.

In the following chapter, all UIDs except implementation class UID are generated from AW4.7 Anonymous Maker base UID: 1.2.840.113619.2.379.

Please note that UID chaining will be maintained within the same session: i.e: if an image references another image, the two anonymized images will still be correctly referenced.

13.3 REAL WORLD ACTIVITY

The user is able to modify the Patient Name and Patient ID and to select the following preferences when de-identifying a set of DICOM images.

- Keep or not Accession Number
- Keep or not Study ID
- Keep or not Institution Name
- Keep or not Study Description
- Keep or not Series Description
- Keep or not Protocol Name
- Keep or not Patient's Sex
- Keep or not Patient's Age
- Keep or not Patient's Size, Patient's Weight
- Keep the original dates or modify all dates relatively to a user defined reference

date

Note: No option shall be kept in order to be compliant with the Basic Application Level Confidentiality Profile Attributes modifications as indicated in DICOM PS 3.15 – Annex E.

13.4 PROCESSING OF IODS

The following IODs are processed:

CR Image Stotage	1.2.840.10008.5.1.4.1.1.1
Digital X-Ray Image Storage - For Presentation	1.2.840.10008.5.1.4.1.1.1.1
Digital X-Ray Image Storage - For Processing	1.2.840.10008.5.1.4.1.1.1.1.1
Digital Mammography X-Ray Image Storage - For Presentation	1.2.840.10008.5.1.4.1.1.1.2
Digital Mammography X-Ray Image Storage - For Processing	1.2.840.10008.5.1.4.1.1.1.2.1
CT Image Storage	1.2.840.10008.5.1.4.1.1.2
Ultrasound Multi-Frame Image Storage (Retired)	1.2.840.10008.5.1.4.1.1.3
Ultrasound Multi-Frame Image Storage	1.2.840.10008.5.1.4.1.1.3.1
MR Image Storage	1.2.840.10008.5.1.4.1.1.4
Ultrasound Image Storage (Retired)	1.2.840.10008.5.1.4.1.1.6
Ultrasound Image Storage	1.2.840.10008.5.1.4.1.1.6.1
Standalone Overlay Storage	1.2.840.10008.5.1.4.1.1.8
Standalone Curve Storage	1.2.840.10008.5.1.4.1.1.9
X-Ray Angiographic Image Storage	1.2.840.10008.5.1.4.1.1.12.1
X-Ray Radiofluoroscopic Image Storage	1.2.840.10008.5.1.4.1.1.12.2
Nuclear Medecine Image Storage	1.2.840.10008.5.1.4.1.1.20
Positron Emission Tomography Image Storage	1.2.840.10008.5.1.4.1.1.128
Standalone PET Curve Storage	1.2.840.10008.5.1.4.1.1.129
RT Image Storage	1.2.840.10008.5.1.4.1.1.481.1
RT Structure Set Storage	1.2.840.10008.5.1.4.1.1.481.3
RT Plan Storage	1.2.840.10008.5.1.4.1.1.481.5

The following IODs are processed but a warning message is displayed to the user when such an IOD is processed.

Secondary Capture Image Storage	1.2.840.10008.5.1.4.1.1.7
Grayscale Softcopy Presentation State Storage	1.2.840.10008.5.1.4.1.1.11.1

The IODs containing the DICOM fields indicated in the table below are processed but a warning message is displayed to the user.

Curves	(50xx,xxxx)
Overlays	(60xx,xxxx)

Note: A warning may also be displayed to the user when some private DICOM fields generated by GE Medical Systems devices are present in the original IOD.

Note: Note: All other IODs are never processed:

**TABLE 13-1
 MODIFIED ATTRIBUTES DESCRIPTION**

Attribute Name	Tag	Private Creator	VR	VM	Description
Media SOP Instance UID	(0002,0003)	n/a	UI	1	Generated from GE Based UID: <station configuration> and timestamp The generated UID is identical to the generated SOP Instance UID
Implementation Class UID	(0002,0012)	n/a	UI	1	1.2.840.113619.6.379
Implementation Version Name	(0002,0013)	n/a	SH	1	dynamically set through an environment variable
Source AET	(0002,0016)	n/a	AE	1	Removed attribute
Private Information Creator UID	(0002,0100)	n/a	UI	1	Removed attribute
Specific Character Set	(0008,0005)	n/a	CS	1-N	<ul style="list-style-type: none"> If non present in the original image, and if the new Patient Name contains non English character(s), set to "ISO_IR 100" Original value otherwise
Instance Creator UID	(0008,0014)	n/a	UI	1	Removed attribute
SOP Instance UID	(0008,0018)	n/a	UI	1	Generated from GE Based UID: <station configuration> and timestamp The generated UID is identical to the generated Media SOP Instance UID
Accession Number	(0008,0050)	n/a	SH	1	Following user preferences <ul style="list-style-type: none"> Original Value If present in the original image, set to an empty value

**VS7 – ADVANTAGE WORKSTATION 4.7
DICOM CONFORMANCE STATEMENT**

GE Healthcare

DIR 5479848-1EN REV 1

Institution Name	(0008,0080)	n/a	LO	1	Following user preferences <ul style="list-style-type: none"> • Original Value • If present in the original image, set to an empty value
Institution Address	(0008,0081)	n/a	ST	1	Removed attribute
Referring Physician's Name	(0008,0090)	n/a	PN	1	If present in the original image, set to an empty value
Referring Physician's Address	(0008,0092)	n/a	ST	1	Removed attribute
Referring Physician's Telephone Numbers	(0008,0094)	n/a	SH	1-N	Removed attribute
Station Name	(0008,1010)	n/a	SH	1	Removed attribute
Study Description	(0008,1030)	n/a	LO	1	Following user preferences <ul style="list-style-type: none"> • Original Value • If present in the original image, set to an empty value
Series Description	(0008,103E)	n/a	LO	1	Following user preferences <ul style="list-style-type: none"> • Original Value • Removed Attribute
Institutional Department Name	(0008,1040)	n/a	LO	1	Removed attribute
Physician(s) of Record	(0008,1048)	n/a	PN	1-N	Removed attribute
Performing Physicians' Name	(0008,1050)	n/a	PN	1-N	Removed attribute
Name of Physician(s) Reading Study	(0008,1060)	n/a	PN	1-N	Removed attribute
Operators' Name	(0008,1070)	n/a	PN	1-N	present in the original image, set to an empty value
Admitting Diagnoses Description	(0008,1080)	n/a	LO	1-N	Removed attribute
Referenced SOP Instance UID	(0008,1155)	n/a	UI	1	Generated from GE Based UID: <station configuration> and timestamp
Derivation Description	(0008,2111)	n/a	ST	1	Removed attribute
Patient's Name	(0010,0010)	n/a	PN	1	User defined value
Patient ID	(0010,0020)	n/a	LO	1	Set to a random value for all images
Patient's Birth Date	(0010,0030)	n/a	DA	1	If present in the original image, set to an empty value
Patient's Birth Time	(0010,0032)	n/a	TM	1	Removed attribute
Patient's Sex	(0010,0040)	n/a	CS	1	Following user preferences <ul style="list-style-type: none"> • Original Value • If present in the original image, set to an empty value
Other Patient Ids	(0010,1000)	n/a	LO	1-N	Removed attribute
Other Patient Names	(0010,1001)	n/a	PN	1-N	Removed attribute

Patient's Birth Name	(0010,1005)	n/a	PN	1	Removed attribute
Patient's Age	(0010,1010)	n/a	AS	1	Following the user preference <ul style="list-style-type: none"> • Original Value • Removed Attribute
Patient's Size	(0010,1020)	n/a	DS	1	Following the user preference <ul style="list-style-type: none"> • Original Value • Removed Attribute
Patient's Weight	(0010,1030)	n/a	DS	1	Following the user preference <ul style="list-style-type: none"> • Original Value • Removed Attribute
Patient's Address	(0010,1040)	n/a	LO	1	Removed attribute
Patient's Mother Birth Name	(0010,1060)	n/a	PN	1	Removed attribute
Military Rank	(0010,1080)	n/a	LO	1	Removed attribute
Branch of Service	(0010,1081)	n/a	LO	1	Removed attribute
Medical Record Locator	(0010,1090)	n/a	LO	1	Removed attribute
Region of Residence	(0010,2152)	n/a	LO	1	Removed attribute
Patient's Telephone numbers	(0010,2154)	n/a	SH	1-N	Removed attribute
Ethnic Group	(0010,2160)	n/a	SH	1	Removed attribute
Occupation	(0010,2180)	n/a	SH	1	Removed attribute
Additional Patient's History	(0010,21B0)	n/a	LT	1	Removed attribute
Patient Comments	(0010,4000)	n/a	LT	1	Removed attribute
Device Serial Number	(0018,1000)	n/a	LO	1	If present in the original image, set to an empty value
Protocol Name	(0018,1030)	n/a	LO	1	Following the user preference <ul style="list-style-type: none"> • Original Value • Removed Attribute
Study Instance UID	(0020,000D)	n/a	UI	1	Generated from GE Based UID: <station configuration> and timestamp
Series Instance UID	(0020,000E)	n/a	UI	1	Generated from GE Based UID: <station configuration> and timestamp
Study ID	(0020,0010)	n/a	SH	1	Following user preferences <ul style="list-style-type: none"> • Original Value • If present in the original image, set to an empty value
Frame of Reference UID	(0020,0052)	n/a	UI	1	If present in the original image, generated from GE Based UID: <station configuration> and timestamp
Synchronization Frame of Reference UID	(0020,0200)	n/a	UI	1	If present in the original image, generated from GE Based UID: <station configuration> and timestamp

**VS7 – ADVANTAGE WORKSTATION 4.7
DICOM CONFORMANCE STATEMENT**

GE Healthcare

DIR 5479848-1EN REV 1

Image Comments	(0020,4000)	n/a	LT	1	Removed attribute
Concatenation UID	(0020,9161)	n/a	UI	1	If present in the original image, generated from GE Based UID: <station configuration> and timestamp
Dimension Organization UID	(0020,9164)	n/a	UI	1	If present in the original image, generated from GE Based UID: <station configuration> and timestamp
Palette Color Lookup Table UID	(0028,1199)	n/a	UI	1	If present in the original image, generated from GE Based UID: <station configuration> and timestamp
Requesting Physician	(0032,1032)	n/a	PN	1	Removed attribute
Requesting Service	(0032,1033)	n/a	LO	1	Removed attribute
Scheduled Performing Physician's Name	(0040,0006)	n/a	PN	1	Removed attribute
Scheduled Station Name	(0040,0010)	n/a	SH	1-N	Removed attribute
Scheduled Procedure Step Location	(0040,0011)	n/a	SH	1	Removed attribute
Performed Station Name	(0040,0242)	n/a	SH	1	Removed attribute
Performed Location	(0040,0243)	n/a	SH	1	Removed attribute
Request Attributes Sequence	(0040,0275)	n/a	SQ	1	Removed attribute
Names of Intended Recipients of Results	(0040,1010)	n/a	PN	1-N	Removed attribute
Order Entered By	(0040,2008)	n/a	PN	1	Removed attribute
Order Enterer's Location	(0040,2009)	n/a	SH	1	Removed attribute
Order Callback Phone Number	(0040,2010)	n/a	SH	1	Removed attribute
Scheduled Station Name Code Sequence	(0040,4025)	n/a	SQ	1	Removed attribute
Scheduled Station Geographic Location Code Sequence	(0040,4027)	n/a	SQ	1	Removed attribute
Performed Station Geographic Location Code Sequence	(0040,4030)	n/a	SQ	1	Removed attribute
Human Performer's Organization	(0040,4036)	n/a	LO	1	Removed attribute
Human Performer's Name	(0040,4037)	n/a	PN	1	Removed attribute
Verifying Observer's Name	(0040,A075)	n/a	PN	1	If present in the original image, set to an empty value
Person Name	(0040,A123)	n/a	PN	1	If present in the original image, set to an empty value
UID	(0040,A124)	n/a	UI	1	If present in the original image, generated from GE Based UID: <station configuration> and timestamp

Content Sequence	(0040,A730)	n/a	SQ	1	Removed attribute
Presentation Creator's Name	(0070,0084)	n/a	PN	1	If present in the original image, set to an empty value
Fiducial UID	(0070,031A)	n/a	UI	1	If present in the original image, generated from GE Based UID: <station configuration> and timestamp
Storage Media File-set UID	(0088,0140)	n/a	UI	1	If present in the original image, generated from GE Based UID: <station configuration> and timestamp
Topic Author	(0088,0910)	n/a	LO	1	If present in the original image, set to an empty value
Digital Signature UID	(0400,0100)	n/a	UI	1	If present in the original image, generated from GE Based UID: <station configuration> and timestamp
Radiation Machine Name	(3002,0020)	n/a	SH	1	If present in the original image, set to an empty value
Referenced Frame of Reference UID	(3006,0024)	n/a	UI	1	If present in the original image, generated from GE Based UID: <station configuration> and timestamp
ROI Interpreter	(3006,00A6)	n/a	PN	1	If present in the original image, set to an empty value
Related Frame of Reference UID	(3006,00C2)	n/a	UI	1	If present in the original image, generated from GE Based UID: <station configuration> and timestamp
Dose Reference UID	(300A,0013)	n/a	UI	1	If present in the original image, generated from GE Based UID: <station configuration> and timestamp
Treatment Machine Name	(300A,00B2)	n/a	SH	1	If present in the original image, set to an empty value
Brachy Accessory Device Name	(300A,0266)	n/a	LO	1	Removed attribute
Source Applicator Name	(300A,0294)	n/a	LO	1	Removed attribute
Receiver Name	(300E,0008)	n/a	PN	1	If present in the original image, set to an empty value
Interpretation Recorder	(4008,0102)	n/a	PN	1	Removed attribute
Interpretation Transcriber	(4008,010A)	n/a	PN	1	Removed attribute
Interpretation Author	(4008,010C)	n/a	PN	1	If present in the original image, set to an empty value
Physician Approving Interpretation	(4008,0114)	n/a	PN	1	Removed attribute
Distribution Name	(4008,0119)	n/a	PN	1	Removed attribute
Distribution Address	(4008,011A)	n/a	LO	1	Removed attribute

Note: Fields which are used for DICOM encoding but have no semantics, for example a group length field, may be also modified.

GE Healthcare

DIR 5479848-1EN REV 1

Note: GE Medical Systems Private fields are specifically managed. However, this management is not described in this document.

Note: Unknown private and standard DICOM 2015b attributes are removed (see: [DICOM 2015b](ftp://medical.nema.org/medical/dicom/2015b/) - ftp://medical.nema.org/medical/dicom/2015b/).

14. QUERY IMPLEMENTATION

14.1 ADVANTAGE WORKSTATION MAPPING OF DICOM ENTITIES

The Advantage Workstation maps DICOM Information Entities to local Information Entities in the product’s database and user interface.

TABLE 26-1
MAPPING OF DICOM ENTITIES TO ADVANTAGE WORKSTATION ENTITIES

DICOM	Advantage Workstation Entity
Patient	Patient
Study	Exam
Series	Series
Image	Image

14.2 INFORMATION MODEL KEYS

Please refer to DICOM Standard PS 3.4 (Service Class Specifications) for a description of each of the levels contained within the Query/Retrieve Information Model.

14.2.1 Common Query Keys

The query key attributes specified in this section are used at all levels and in all classes of query.

TABLE 14-2
Q/R COMMON RETRIEVE ATTRIBUTES

Attribute Name	Tag	Type	SCU Use	SCP Use
Specific Character Set	(0008,0005)	-	See 14.2.1.1.1	See 14.2.1.1.1
Query Retrieve Level	(0008,0052)	-	Set to level of query: STUDY SERIES IMAGE	Matched to level of query
Retrieve AE Title	(0008,0054)	-	Attribute is not requested. Returned value is not used.	Always returned with AE Title of <name of DICOM Server AE>
Storage Media File-set ID	(0088,0130)	-	Attribute is not requested. Returned value is ignored	Not used.
Storage Media File-set UID	(0088,0140)	-	Attribute is not requested. Returned value is ignored	Not used.

14.2.1.1 Q/R Common Attribute Descriptions

If an optional key is requested that does not appear in any of the tables below, that key will be ignored and no corresponding element will be returned.

If the database does not have a value corresponding to any requested optional key a zero-length element will be returned.

Sequence matching is not supported.

The AE does not support Relational Search. Therefore, the C-FIND SCP will not perform any extended negotiation.

The AE supports case-insensitive matching for the attributes of Value Representation PN: Patient's Name (0010,0010).

14.2.1.1.1 Specific Character Set

As an SCU, the attribute Specific Character Set (0008,0005) will not be sent, unless a patient or physician name is sent with a matching key that may include a non-ASCII character; in that case, the extended character set identifier read from the local DICOM entity will be sent. No non-ASCII characters may be entered from the console keyboard. Query response item text attributes, including patient and physician names, that include non-ASCII characters will be displayed as described in Section 2.7.

As an SCP, if the attribute Specific Character Set (0008,0005) is received the key attributes will be converted to Unicode string and matching will be done in Unicode format. Specific Character Set of the matching DICOM Object will be sent in Query responses.

14.2.2 Study Level – Study Root

This section defines the keys at the Study Level of the Study Root Query/Retrieve Information Model that are supported by this implementation.

**TABLE 14-3
STUDY LEVEL ATTRIBUTES FOR THE STUDY ROOT
QUERY/RETRIEVE INFORMATION MODEL**

Attribute Name	Tag	Type	SCU Use	SCP Use
Study Date	(0008,0020)	R*	Matching is requested if enabled in the current filter.	Date Range matched
Study Time	(0008,0030)	R*	Matching is requested if enabled in the current filter.	Time Range matched
Accession Number	(0008,0050)	R*	Matching is requested if enabled in the current filter. Equality and wildchar matching is supported with <value>*, or *<value>*.	Matched. Both ? and * matching supported with any occurrence.
Study ID	(0020,0010)	R*	Zero length.	Only ASCII IDs are matched correctly. Both ? and * matching supported with any occurrence.

Patient's Name	(0010,0010)	R*	Matching is requested if enabled in the current filter. Equality and wildchar matching is supported with <value>*, or *<value>*. See 2.3.1.2.2.3.1.1 for more information.	Matched. Case insensitive ? and * matching supported with any occurrence. '^' and '' characters match themselves only, that is 'Smith^Joe' in query does not matches 'Smith Joe' in the database.
Patient ID	(0010,0020)	R*	Matching is requested if enabled in the current filter. Equality and wildchar matching is supported with <value>*, or *<value>*.	Matched. Both ? and * matching supported with any occurrence.
Study Instance UID	(0020,000D)	U	Zero length	Matched
Modalities in Study	(0008,0061)	O*	Matching is requested if enabled in the current filter. Value multiplicity is 0-n.	Mutiple value matching is supported. No wildchar matching is supported.
Referring Physician's Name	(0008,0090)	O*	Zero length.	Matched. Both ? and * matching supported with any occurrence.
Study Description	(0008,1030)	O*	Zero length.	This element is only returned.
Patient's Birth Date	(0010,0030)	O	Zero length.	Not matched and not returned.
Patient's Sex	(0010,0040)	O	Zero length.	This element is only returned.

Note: * in the *Type* column indicates that this information is displayed on screen by SCU, if available

14.2.3 Series Level

This section defines the keys at the Series Level of the Study Root Query/Retrieve Information Models that are supported by this implementation.

TABLE 14-4
SERIES LEVEL ATTRIBUTES FOR THE
QUERY/RETRIEVE INFORMATION MODEL

Attribute Name	Tag	Type	SCU Use	SCP Use
Modality	(0008,0060)	R*	Zero length.	Matched. Both ? and * matching supported with any occurrence.
Series Number	(0020,0011)	R*	Zero length.	Matched. Both ? and * matching supported with any occurrence.

Series Instance UID	(0020,000E)	U	Zero length.	Matched
Series Description	(0008,103E)	O*	Zero length.	This element is only returned.

Note: * in the *Type* column indicates that this information is displayed on screen by SCU, if available

14.2.4 Image Level

This section defines the keys at the Image Level of the Patient Root and Study Root Query/Retrieve Information Models that are supported by this implementation.

**TABLE 14-5
IMAGE LEVEL ATTRIBUTES FOR THE
QUERY/RETRIEVE INFORMATION MODEL**

Attribute Name	Tag	Type	SCU Use	SCP Use
Instance Number	(0020,0013)	R*	Zero length.	Matched
SOP Instance UID	(0008,0018)	U	Zero length.	Matched
SOP Class UID	(0008,0016)	O	Zero length.	Matched
Rows	(0028,0010)	O*	Zero length.	Only returned for CT, MR, NM, PT, RF, XA objects.
Columns	(0028,0011)	O*	Zero length.	Only returned for CT, MR, NM, PT, RF, XA objects.
Number of Frames	(0028,0008)	O*	Zero length.	Only returned for NM, RF, US, XA objects.
Content Label	(0070,0080)	O*	Zero length.	Matched and returned for Presentation and Registration objects. Only ASCII strings are matched correctly. Both ? and * matching supported with any occurrence.
Content Description	(0070,0081)	O*	Zero length.	Matched and returned for Presentation and Registration objects. Only ASCII strings are matched correctly. Both ? and * matching supported with any occurrence.
Presentation Creation Date	(0070,0082)	O*	Zero length.	Range matched and returned for Presentation objects.
Presentation Creation Time	(0070,0083)	O*	Zero length.	Range matched and returned for Presentation objects.

**VS7 – ADVANTAGE WORKSTATION 4.7
DICOM CONFORMANCE STATEMENT**

GE Healthcare

DIR 5479848-1EN REV 1

Presentation Creator's Name	(0070,0084)	O	Zero length.	Matched and returned for Presentation and Registration objects. Only ASCII strings are matched correctly. Both ? and * matching supported with any occurrence.
Completion Flag	(0040,A491)	O	Zero length	Matched and returned only for Structured Report objects.
Verification Flag	(0040,A493)	O	Zero length	Matched and returned only for Structured Report objects.
Content Date	(0008,0023)	O*	Zero length.	Range matched for Registration objects. Returned for all objects.
Content Time	(0008,0033)	O*	Zero length.	Range matched for Registration objects. Returned for all objects.
Image Comments	(0020,4000)	O*	Zero length.	This element is only returned.
Slice Thickness	(0018,0050)	O*	Zero length.	Only returned for CT, MR objects.
Spacing Between Slices	(0018,0088)	O*	Zero length.	Only returned for CT, MR objects.
Gantry Detector Tilt	(0018,1120)	O*	Zero length.	Only returned for CT objects.
Convolution Kernel	(0018,1210)	O*	Zero length.	Only returned for CT objects.
Body Part Examined	(0018,0015)	O*	Zero length.	Only returned for MG objects.
Repetition Time	(0018,0080)	O*	Zero length.	Only returned for MR objects.
Echo Time	(0018,0081)	O*	Zero length.	Only returned for MR objects.
Inversion Time	(0018,0082)	O*	Zero length.	Only returned for MR objects.
Echo Number(s)	(0018,0086)	O*	Zero length.	Only returned for MR objects.
Trigger Time	(0018,1060)	O*	Zero length.	Only returned for MR objects.
Flip Angle	(0018,1314)	O*	Zero length.	Only returned for MR objects.
Counts Source	(0054,1002)	O*	Zero length.	Only returned for PT objects.
Image Index	(0054,1330)	O*	Zero length.	Only returned for PT objects.

Recommended Display Frame Rate	(0008,2144)	O*	Zero length.	Only returned for RF objects.
Radiation Setting	(0018,1155)	O*	Zero length.	Only returned for RF objects.
Heart Rate	(0018,1088)	O*	Zero length.	Only returned for US objects.
Operators Name	(0008,1070)	O*	Zero length.	Only returned for RT objects.
RT Image Label	(3002,0002)	O*	Zero length.	Only returned for RT objects.
RT Image Name	(3002,0003)	O*	Zero length.	Only returned for RT objects.
Structure Set Label	(3006,0002)	O*	Zero length.	Only returned for RT objects.
Structure Set Name	(3006,0004)	O*	Zero length.	Only returned for RT objects.
RT Plan Label	(300A,0002)	O*	Zero length.	Only returned for RT objects.
RT Plan Name	(300A,0003)	O*	Zero length.	Only returned for RT objects.
Sequence Variant	(0018,0021)	O*	Zero length.	Not matched, not returned.
Data Collection Diameter	(0018,0090)	O*	Zero length.	Not matched, not returned.
Reconstruction Diameter	(0018,1100)	O*	Zero length.	Not matched, not returned.
Image Orientation (Patient)	(0020,0037)	O*	Zero length.	Not matched, not returned.
Slice Location	(0020,1041)	O*	Zero length.	Not matched, not returned.

Note: * in the *Type* column indicates that this information is displayed on screen by SCU, if available

14.3 PRIVATE DATA ATTRIBUTES

The Product supports the Private Attributes defined in the following sections in Query identifiers.

14.3.1 Private Group GEMS_DIRECT_CONNECT

Private Group GEMS_DIRECT_CONNECT is modeled at the Study / Series / Image Query Level. It is requested in query and returned by SCP if the remote DICOM host is declared with Direct Connect option locally.

**TABLE 14-6
PRIVATE GROUP GEMS_DIRECT_CONNECT**

Attribute Name	Tag	VR	VM	Attribute Description and Use
Private Creator Identification	(0055,00xx)	LO	1	Always filled with GEMS_DIRECT_CONNECT
Patient Folder Path	(0055,xx01)	UT	1	Relative path of the patient's folder on the shared drive.
Study Folder Path	(0055,xx02)	UT	1	Relative path of the study's folder on the

**VS7 – ADVANTAGE WORKSTATION 4.7
DICOM CONFORMANCE STATEMENT**

GE Healthcare

DIR 5479848-1EN REV 1

				shared drive.
Series Folder Path	(0055,xx03)	UT	1	Relative path of the series's folder on the shared drive.
Image Folder Path	(0055,xx04)	UT	1	Relative path of the image's folder on the shared drive.
Database Id	(0055,xx05)	ST	1	The identifier of the database.