

Technical Publications

Direction DOC2122827
Revision 2

**Vivid E95/E90/E80/S70N/S60N/iq/T8/T9
Version 203**

**CONFORMANCE STATEMENT
for DICOM**

Copyright© 2018 By General Electric Co.

Do not duplicate



GE Ultrasound

THIS PAGE LEFT INTENTIONALLY BLANK

CONFORMANCE STATEMENT OVERVIEW

The Vivid is an Ultrasound scanner acting as an acquisition modality in a DICOM network.

Table 0.1 provides an overview of the network services supported by Vivid scanner.

Table 0.1 – NETWORK SERVICES

SOP Classes	User of Service (SCU)	Provider of Service (SCP)
Transfer		
Ultrasound Multi-frame Image Storage	Yes	Yes
Ultrasound Image Storage	Yes	Yes
Ultrasound Multi-frame Image Storage (Retired)	Yes	Yes
Ultrasound Image Storage (Retired)	Yes	Yes
Secondary Capture Image Storage	Yes	Yes
Comprehensive SR	Yes	No
CT Image Storage *	No	Yes
Enhanced CT Image Storage *	No	Yes
Query/Retrieve		
Study Root Query/Retrieve Information Model – FIND	Yes	No
Study Root Query/Retrieve Information Model – MOVE	Yes	No
Print Management		
Basic Grayscale Print Management Meta SOP Class	Yes	No
Basic Color Print Management Meta SOP Class	Yes	No
Workflow Management		
Storage Commitment Push Model SOP Class	Yes	No
Modality Performed Procedure Step SOP Class	Yes	No
Modality Worklist Information Model – FIND SOP Class	Yes	No

Option*: This means that this service can be purchased separately and may be available only on certain models.

Table 0.2 provides an overview of the Media Storage Application Profiles supported by the Vivid scanner.

Table 0.2 – MEDIA SERVICES

Media Storage Application Profile	Write Files (FSC or FSU)	Read Files (FSR)
Compact Disk – Recordable		
US Spatial Calibration Single Frame CD-R (augmented, see 3.3.1)	Yes	Yes
US Spatial Calibration Multi-frame CD-R (augmented, see 3.3.1)	Yes	Yes
DVD		
US Spatial Calibration Single Frame DVD (augmented, see 3.3.1)	Yes	Yes
US Spatial Calibration Multi-frame DVD (augmented, see 3.3.1)	Yes	Yes
USB		
General Purpose USB Media Interchange (augmented, see 3.3.1)	Yes	Yes

Option*: This means that this service can be purchased separately

TABLE OF CONTENTS

1. INTRODUCTION	1
1.1 OVERVIEW.....	1
1.2 OVERALL DICOM CONFORMANCE STATEMENT DOCUMENT STRUCTURE.....	3
1.3 INTENDED AUDIENCE	4
1.4 SCOPE AND FIELD OF APPLICATION	4
1.5 IMPORTANT REMARKS	4
1.6 REFERENCES.....	5
1.7 DEFINITIONS	5
1.8 SYMBOLS AND ABBREVIATIONS	7
2. NETWORK CONFORMANCE STATEMENT	9
2.1 INTRODUCTION.....	9
2.2 IMPLEMENTATION MODEL	9
2.2.1 Application Data Flow Diagram	9
2.2.2 Functional Definition of AE's.....	11
2.2.3 Sequencing of Real-World Activities.....	11
2.3 AE SPECIFICATIONS	12
2.3.1 Vivid v203 AE Specification	12
2.4 COMMUNICATION PROFILES.....	21
2.4.1 Supported Communication Stacks (PS 3.8, PS 3.9).....	21
2.4.2 TCP/IP Stack.....	22
2.4.3 Additional Protocols	22
2.4.4 IPv4 and IPv6 Support	22
2.5 EXTENSIONS / SPECIALIZATIONS / PRIVATIZATIONS	22
2.6 CONFIGURATION.....	23
2.6.1 AE Title/Presentation Address Mapping.....	23
2.6.2 Configurable Parameters	23
2.7 SUPPORT OF EXTENDED CHARACTER SETS	24
2.8 CODES AND CONTROLLED TERMINOLOGY	24
2.8.1 Fixed Coded Terminology	24
2.9 SECURITY PROFILES	24

3.	MEDIA STORAGE CONFORMANCE STATEMENT	25
3.1	INTRODUCTION.....	25
3.2	IMPLEMENTATION MODEL	25
3.2.1	Application Data Flow Diagram	25
3.2.2	Functional Definition of AE's.....	25
3.2.3	Sequencing Requirements	26
3.2.4	File Meta Information Options (See PS3.10).....	26
3.3	AE SPECIFICATIONS	26
3.3.1	Vivid v203 AE Specification	26
3.4	AUGMENTED AND PRIVATE APPLICATION PROFILES	31
3.5	EXTENSIONS, SPECIALIZATIONS, PRIVATIZATIONS OF SOP CLASSES AND TRANSFER SYNTAXES.....	31
3.6	CONFIGURATION.....	31
3.7	SUPPORT OF EXTENDED CHARACTER SETS	32
4.	ULTRASOUND (US) INFORMATION OBJECT IMPLEMENTATION.....	33
4.1	INTRODUCTION.....	33
4.2	US IOD IMPLEMENTATION.....	33
4.3	US ENTITY-RELATIONSHIP MODEL	33
4.3.1	Entity Descriptions.....	34
4.3.2	Vivid v203 Mapping of DICOM Entities.....	34
4.4	IOD MODULE TABLE.....	35
4.5	INFORMATION MODULE DEFINITIONS.....	35
4.5.1	Common Patient Entity Modules	36
4.5.2	Common Study Entity Modules	37
4.5.3	Common Series Entity Modules.....	39
4.5.4	Common Equipment Entity Modules	40
4.5.5	Common Image Entity Modules	40
4.5.6	General Modules.....	44
4.5.7	US Modules	44
5.	ULTRASOUND MULTIFRAME (US MF) INFORMATION OBJECT IMPLEMENTATION	50
5.1	INTRODUCTION.....	50
5.2	US MF IOD IMPLEMENTATION.....	50
5.3	US MF ENTITY-RELATIONSHIP MODEL	50
5.3.1	Entity Descriptions.....	51
5.3.2	Vivid v203 Mapping of DICOM entities	51

5.4	IOD MODULE TABLE.....	52
5.5	INFORMATION MODULE DEFINITIONS.....	52
5.5.1	Common Image Modules	53
6.	SC INFORMATION OBJECT IMPLEMENTATION	54
6.1	INTRODUCTION.....	54
6.2	SC IOD IMPLEMENTATION.....	54
6.3	SC ENTITY-RELATIONSHIP MODEL	54
6.3.1	Entity Descriptions.....	55
6.3.2	Vivid v203 Mapping of DICOM Entities.....	55
6.4	IOD MODULE TABLE.....	56
6.5	INFORMATION MODULE DEFINITIONS.....	56
6.5.1	SC Modules.....	56
7.	SR INFORMATION OBJECT IMPLEMENTATION	58
7.1	INTRODUCTION.....	58
7.2	COMPREHENSIVE SR IOD IMPLEMENTATION	58
7.3	COMPREHENSIVE SR ENTITY-RELATIONSHIP MODEL	58
7.3.1	Entity Descriptions.....	59
7.3.2	Vivid v203 Mapping of DICOM Entities.....	59
7.4	IOD MODULE TABLE.....	60
7.5	INFORMATION MODULE DEFINITIONS.....	60
7.5.1	SR Document Series Module	61
7.5.2	SR Document General Module	61
7.5.3	SR Document Content Module	63
7.6	STANDARD EXTENDED AND PRIVATE DATA ATTRIBUTES	64
7.7	STANDARD EXTENDED AND PRIVATE CONTEXT GROUPS	64
7.8	STANDARD EXTENDED AND PRIVATE TEMPLATES.....	64
7.8.1	Standard Extended Templates.....	64
7.8.2	Private Templates.....	64
7.8.3	Additional Private Element information	64
8.	BASIC DIRECTORY INFORMATION OBJECT IMPLEMENTATION	68
8.1	INTRODUCTION.....	68
8.2	BASIC DIRECTORY IOD IMPLEMENTATION.....	68
8.3	BASIC DIRECTORY ENTITY-RELATIONSHIP MODEL	68

8.3.1	Vivid v203 Mapping of DICOM entities	68
8.4	IOD MODULE TABLE.....	69
8.5	INFORMATION MODULE DEFINITIONS.....	70
8.5.1	Common File Set identification Modules.....	70
8.5.2	Common Directory Information Modules	70
8.5.3	Definition of Specific Directory Records.....	72
8.6	PRIVATE DATA DICTIONARY	77
9.	MODALITY WORKLIST INFORMATION MODEL DEFINITION.....	78
9.1	INTRODUCTION.....	78
9.2	MODALITY WORKLIST INFORMATION MODEL DESCRIPTION	78
9.3	MODALITY WORKLIST INFORMATION MODEL ENTITY-RELATIONSHIP MODEL.....	78
9.3.1	Entity Descriptions.....	79
9.3.2	Vivid v203 Mapping of DICOM entities	80
9.4	INFORMATION MODEL MODULE TABLE	80
9.5	INFORMATION MODEL KEYS.....	81
9.5.1	Supported Matching	81
9.5.2	Scheduled Procedure Step Entity	82
9.5.3	Requested Procedure Entity	83
9.5.4	Imaging Service Request Entity	84
9.5.5	Visit Entity	84
9.5.6	Patient Entity.....	85
10.	MODALITY PERFORMED PROCEDURE STEP SOP CLASS DEFINITION	88
10.1	INTRODUCTION.....	88
10.2	MODALITY PERFORMED PROCEDURE STEP SOP CLASS DEFINITION	88
10.2.1	IOD Description.....	88
10.2.2	Operations	90
11.	STORAGE COMMITMENT PUSH MODEL SOP CLASS DEFINITION.....	91
11.1	INTRODUCTION.....	91
11.2	STORAGE COMMITMENT PUSH MODEL SOP CLASS DEFINITION	91
11.2.1	IOD Description.....	91
11.2.2	DIMSE Service Group	91
11.2.3	Operations	92
11.2.4	Notifications.....	93
12.	PRINT MANAGEMENT SOP CLASS DEFINITION	96
12.1	INTRODUCTION.....	96

12.2	BASIC PRINT MANAGEMENT META SOP CLASSES.....	96
12.2.1	Basic Grayscale Print Management Meta SOP Class.....	96
12.2.2	Basic Color Print Management Meta SOP Class	96
12.3	PRINT MANAGEMENT SOP CLASS DEFINITIONS	97
12.3.1	Basic Film Session SOP Class	97
12.3.2	Basic Film Box SOP Class.....	97
12.3.3	Image Box SOP Class	98
12.3.4	Printer SOP Class.....	99
12.4	PRINT MANAGEMENT IODS	99
12.4.1	Film Session IOD Module	100
12.4.2	Basic Film Box IOD Module Table	100
12.4.3	Basic Image Box IOD Module Table.....	100
12.4.4	Printer IOD Module Table	100
12.5	INFORMATION MODULE DEFINITIONS.....	100
12.5.1	General Modules.....	101
12.5.2	Print Management Modules	101
13.	STUDY ROOT QUERY/RETRIEVE INFORMATION MODEL DEFINITION	107
13.1	INTRODUCTION.....	107
13.2	STUDY ROOT INFORMATION MODEL DESCRIPTION	107
13.3	STUDY ROOT INFORMATION MODEL ENTITY-RELATIONSHIP MODEL.....	107
13.3.1	Entity Descriptions.....	108
13.3.2	Vivid v203 Mapping of DICOM entities	108
13.4	INFORMATION MODEL KEYS.....	108
13.4.1	Supported Matching	109
13.4.2	Study Level	109
13.4.3	Series Level.....	110
13.4.4	Image Level.....	111
13.5	PRIVATE DATA DICTIONARY	112
14.	ADULT AND PEDIATRIC ECHOCARDIOGRAPHY PROCEDURE REPORTS	113
14.1	Usage and extensionS of TID 5200 EchOCardiography Procedure REport	113
14.2	Usage and extension of TID 5220 Pediatric, Fetal and congenital Cardiac Ultrasound Reports	116
14.3	TID 3602 Cardiovascular Patient Characteristics	117
14.4	Measurements mapping to Structured Reports	119
15.	VASCULAR ULTRASOUND PROCEDURE REPORT	246
15.1	Usage and Extension of TID 5100 Vascular Ultrasound Report	246
15.2	TID 5101 Vascular Patient Characteristics	246

15.3	TID 5102 Vascular Procedure Summary Section.....	247
15.4	TID 5103 Vascular Ultrasound Section (extended).....	248
15.5	TID 5104 Vascular Ultrasound Measurement Group	248
15.6	GEU Applications and Extensions.....	250
15.7	TID 300 Measurement	259
15.8	GE Ultrasound Modes	259
15.9	GE Ultrasound Sidedness and Vessel Location	259
15.10	SR Mapping Table for Vascular Base Measurement Concept	260
15.11	Derivation and Selection.....	270
16.	DICOM STRUCTURE REPORTS – USER DEFINED OBJECTS.....	272
16.1	GE Default DICOM EXPORT Format.....	272
16.2	Template Extensions	273
16.2.1	TID5100: Vascular Ultrasound Report Extensions.....	273
16.2.2	TID5200: Adult Echo Template Report Extensions	273
16.2.3	TID5220: Pediatric Template Report Extensions	273
16.2.4	TID9900: User-defined concepts	273
16.2.5	TID9901: User-defined concept.....	274
16.3	User Defined dicom mappings.....	274

1. INTRODUCTION

1.1 OVERVIEW

This DICOM Conformance Statement is divided into Sections as described below:

Section 1 (Introduction), which describes the overall structure, intent, and references for this Conformance Statement

Section 2 (Network Conformance Statement), which specifies the GEHC equipment compliance to the DICOM requirements for the implementation of Networking features.

Section 3 (Media Storage Conformance Statement), which specifies the GEHC equipment compliance to the DICOM requirements for the implementation of Media Storage features.

Section 4 (Ultrasound Information Object Implementation), which specifies the GEHC equipment compliance to DICOM requirements for the implementation of an Ultrasound Medicine Information Object.

Section 5 (Ultrasound Multi-Frame Information Object Implementation), which specifies the GEHC equipment compliance to DICOM requirements for the implementation of an Ultrasound Multi-Frame Information.

Section 6 (SC Object Implementation), which specifies the GEHC equipment compliance to DICOM requirements for the implementation of a Secondary Capture Information Object.

Section 7 (SR Object Implementation), which specifies the GEHC equipment compliance to DICOM requirements for the implementation of a Comprehensive Structured Reporting Information Object.

Section 8 (Basic Directory Information Object Implementation), which specifies the GEHC equipment compliance to DICOM requirements for the implementation of a Basic Directory Information Object.

Section 9 (Modality Worklist Information Model), which specifies the GEHC equipment compliance to DICOM requirements for the implementation of the Modality Worklist service.

Section 10 (Modality Performed Procedure Step SOP Class Definition), which specifies the GEHC equipment compliance to DICOM requirements for the implementation of Modality Performed Procedure Step Service.

Section 11 (Storage Commitment Push Model SOP Class Definition), which specifies the GEHC equipment compliance to DICOM requirements for the implementation of the Storage Commitment Push Model Service.

Section 12 (Basic Print Meta SOP Class Information Object Implementation), which specifies the GEHC equipment compliance to DICOM requirements for the implementation of Basic Print Meta SOP Classes (Gray and Color).

Section 13 (Study Root Query/Retrieve Information Model), which specifies the GEHC equipment compliance to DICOM requirements for the Study Root Query/Retrieve Information Model.

Section 14 (Echocardiography procedure report), which specifies how measurements are mapped to Adult Echocardiography or Pediatric Procedure Report (TID 5200 and TID 5220 respectively) DICOM SR, .

Section 15 (Vascular Ultrasound procedure report), which specifies how measurements are mapped to Vascular Ultrasound Procedure Report (TID 5100) DICOM SR.

1.2 OVERALL DICOM CONFORMANCE STATEMENT DOCUMENT STRUCTURE

The Documentation Structure of the GEHC Conformance Statements and their relationship with the DICOM Conformance Statements is shown in the Illustration below.

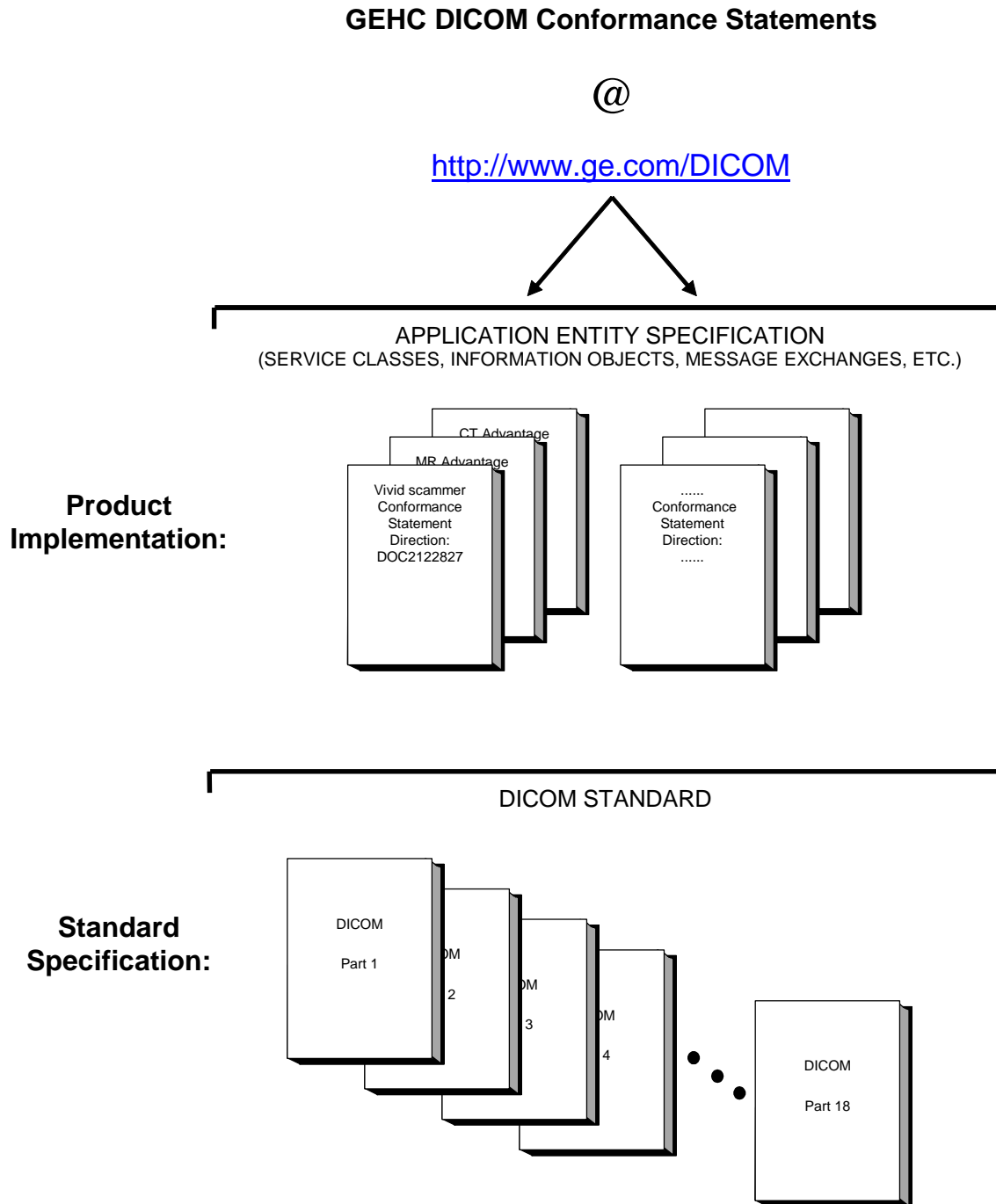

This document specifies the DICOM implementation. It is entitled:

*Vivid version 203
Conformance Statement for DICOM
Direction DOC2122827*

This DICOM Conformance Statement documents the DICOM Conformance Statement and Technical Specification required to interoperate with the GEHC network interface.

The GEHC Conformance Statement, contained in this document, also specifies the Lower Layer communications which it supports (e.g., TCP/IP). However, the Technical Specifications are defined in the DICOM Part 8 standard.

For more information regarding DICOM, copies of the Standard may be obtained on the Internet at <http://medical.nema.org>. Comments on the Standard may be addressed to:

DICOM Secretariat
NEMA
1300 N. 17th Street, Suite 1752
Rosslyn, VA 22209
USA
Phone : +1.703.841.3200

1.3 INTENDED AUDIENCE

The reader of this document is concerned with software design and/or system integration issues. It is assumed that the reader of this document is familiar with the DICOM Standard and with the terminology and concepts which are used in that Standard.

1.4 SCOPE AND FIELD OF APPLICATION

It is the intent of this document to provide an unambiguous specification for GEHC implementations. This specification, called a Conformance Statement, includes a DICOM Conformance Statement and is necessary to ensure proper processing and interpretation of GEHC medical data exchanged using DICOM. The GEHC Conformance Statements are available to the public.

The reader of this DICOM Conformance Statement should be aware that different GEHC devices are capable of using different Information Object Definitions. For example, a GEHC CT Scanner may send images using the CT Information Object, MR Information Object, Secondary Capture Object, etc.

Included in this DICOM Conformance Statement are the Module Definitions which define all data elements used by this GEHC implementation. If the user encounters unspecified private data elements while parsing a GEHC Data Set, the user is well advised to ignore those data elements (per the DICOM standard). Unspecified private data element information is subject to change without notice. If, however, the device is acting as a “full fidelity storage device”, it should retain and re-transmit all of the private data elements which are sent by GEHC devices.

1.5 IMPORTANT REMARKS

The use of these DICOM Conformance Statements, in conjunction with the DICOM Standards, is intended to facilitate communication with GE imaging equipment. However, **by itself, it is not sufficient to ensure that inter-operation will be successful**. The **user (or user’s agent)** needs to proceed with caution and address at least four issues:

- **Integration** – The integration of any device into an overall system of interconnected devices goes beyond the scope of standards (DICOM v3.0), and of this introduction and associated DICOM Conformance

Statements when interoperability with non-GE equipment is desired. The responsibility to analyze the applications requirements and to design a solution that integrates GE imaging equipment with non-GE systems is the **user's** responsibility and should not be underestimated. The **user** is strongly advised to ensure that such an integration analysis is correctly performed.

- **Validation** – Testing the complete range of possible interactions between any GE device and non-GE devices, before the connection is declared operational, should not be overlooked. Therefore, the **user** should ensure that any non-GE provider accepts full responsibility for all validation required for their connection with GE devices. This includes the accuracy of the image data once it has crossed the interface between the GE imaging equipment and the non-GE device and the stability of the image data for the intended applications.

Such a validation is required before any clinical use (diagnosis and/or treatment) is performed. It applies when images acquired on GE imaging equipment are processed/displayed on a non-GE device, as well as when images acquired on non-GE equipment is processed/displayed on a GE console or workstation.

- **Future Evolution** – GE understands that the DICOM Standard will evolve to meet the user's growing requirements. GE is actively involved in the development of the DICOM Standard. DICOM will incorporate new features and technologies and GE may follow the evolution of the Standard. The GEHC protocol is based on DICOM as specified in each DICOM Conformance Statement. Evolution of the Standard may require changes to devices, which have implemented DICOM. **In addition, GE reserves the right to discontinue or make changes to the support of communications features (on its products) reflected on by these DICOM Conformance Statements.** The **user** should ensure that any non-GE provider, which connects with GE devices, also plans for the future evolution of the DICOM Standard. Failure to do so will likely result in the loss of function and/or connectivity as the DICOM Standard changes and GE Products are enhanced to support these changes.
- **Interaction** – It is the sole responsibility of the **non-GE provider** to ensure that communication with the interfaced equipment does not cause degradation of GE imaging equipment performance and/or function.

1.6 REFERENCES

NEMA PS3 Digital Imaging and Communications in Medicine (DICOM) Standard, available free at <https://www.dicomstandard.org/>

DICOM Conformance Statements for the Vivid models and other DICOM implementations, are available at <https://www.gehealthcare.com/en/products/interoperability/dicom/ultrasound-dicom-conformance-statements>. They are identified for the version and model of Ultrasound unit.

1.7 DEFINITIONS

Informal definitions are provided for the following terms used in this Conformance Statement. The DICOM Standard is the authoritative source for formal definitions of these terms.

Abstract Syntax – the information agreed to be exchanged between applications, generally equivalent to a Service/Object Pair (SOP) Class. Examples: Verification SOP Class, Modality Worklist Information Model Find SOP Class, and Computed Radiography Image Storage SOP Class.

Application Entity (AE) – an end point of a DICOM information exchange, including the DICOM network or media interface software; i.e., the software that sends or receives DICOM information objects or messages. A single device may have multiple Application Entities.

Application Entity Title – the externally known name of an *Application Entity*, used to identify a DICOM application to other DICOM applications on the network.

Application Context – the specification of the type of communication used between *Application Entities*. Example: DICOM network protocol.

Association – a network communication channel set up between *Application Entities*.

Attribute – a unit of information in an object definition; a data element identified by a *tag*. The information may be a complex data structure (Sequence), itself composed of lower level data elements. Examples: Patient ID (0010,0020), Accession Number (0008,0050), Photometric Interpretation (0028,0004), Procedure Code Sequence (0008,1032).

Information Object Definition (IOD) – the specified set of *Attributes* that comprise a type of data object; does not represent a specific instance of the data object, but rather a class of similar data objects that have the same properties. The *Attributes* may be specified as Mandatory (Type 1), Required but possibly unknown (Type 2), or Optional (Type 3), and there may be conditions associated with the use of an Attribute (Types 1C and 2C). Examples: MR Image IOD, CT Image IOD, Print Job IOD.

Joint Photographic Experts Group (JPEG) – a set of standardized image compression techniques, available for use by DICOM applications.

Media Application Profile – the specification of DICOM information objects and encoding exchanged on removable media (e.g., CDs)

Module – a set of *Attributes* within an *Information Object Definition* that are logically related to each other. Example: Patient Module includes Patient Name, Patient ID, Patient Birth Date, and Patient Sex.

Negotiation – first phase of *Association* establishment that allows *Application Entities* to agree on the types of data to be exchanged and how that data will be encoded.

Presentation Context – the set of DICOM network services used over an *Association*, as negotiated between *Application Entities*; includes *Abstract Syntaxes* and *Transfer Syntaxes*.

Protocol Data Unit (PDU) – a packet (piece) of a DICOM message sent across the network. Devices must specify the maximum size packet they can receive for DICOM messages.

Security Profile – a set of mechanisms, such as encryption, user authentication, or digital signatures, used by an *Application Entity* to ensure confidentiality, integrity, and/or availability of exchanged DICOM data

Service Class Provider (SCP) – role of an *Application Entity* that provides a DICOM network service; typically, a server that performs operations requested by another *Application Entity* (*Service Class User*). Examples: Picture Archiving and Communication System (image storage SCP, and image query/retrieve SCP), Radiology Information System (modality worklist SCP).

Service Class User (SCU) – role of an *Application Entity* that uses a DICOM network service; typically, a client. Examples: imaging modality (image storage SCU, and modality worklist SCU), imaging workstation (image query/retrieve SCU)

Service/Object Pair (SOP) Class – the specification of the network or media transfer (service) of a particular type of data (object); the fundamental unit of DICOM interoperability specification. Examples: Ultrasound Image Storage Service, Basic Grayscale Print Management.

Service/Object Pair (SOP) Instance – an information object; a specific occurrence of information exchanged in a *SOP Class*. Examples: a specific x-ray image.

Tag – a 32-bit identifier for a data element, represented as a pair of four digit hexadecimal numbers, the “group” and the “element”. If the “group” number is odd, the tag is for a private (manufacturer-specific) data element. Examples: (0010,0020) [Patient ID], (07FE,0010) [Pixel Data], (0019,0210) [private data element]

Transfer Syntax – the encoding used for exchange of DICOM information objects and messages. Examples: *JPEG* compressed (images), little endian explicit value representation.

Unique Identifier (UID) – a globally unique “dotted decimal” string that identifies a specific object or a class of objects; an ISO-8824 Object Identifier. Examples: Study Instance UID, SOP Class UID, SOP Instance UID.

Value Representation (VR) – the format type of an individual DICOM data element, such as text, an integer, a person’s name, or a code. DICOM information objects can be transmitted with either explicit identification of the type of each data element (Explicit VR), or without explicit identification (Implicit VR); with Implicit VR, the receiving application must use a DICOM data dictionary to look up the format of each data element.

1.8 SYMBOLS AND ABBREVIATIONS

AE	Application Entity
AET	Application Entity Title
CD-R	Compact Disk Recordable
CT	Computed Tomography
DHCP	Dynamic Host Configuration Protocol
DICOM	Digital Imaging and Communications in Medicine
DNS	Domain Name System
FSC	File-Set Creator
FSU	File-Set Updater
FSR	File-Set Reader
HIS	Hospital Information System
HL7	Health Level 7 Standard
IHE	Integrating the Healthcare Enterprise
IOD	Information Object Definition
Ipv4	Internet Protocol version 4
Ipv6	Internet Protocol version 6
ISO	International Organization for Standards
JPEG	Joint Photographic Experts Group
LUT	Look-up Table
MPPS	Modality Performed Procedure Step
MSPS	Modality Scheduled Procedure Step

MTU Maximum Transmission Unit (IP)

MWL Modality Worklist

- Optional (Key Attribute)

OSI Open Systems Interconnection

PACS Picture Archiving and Communication System

PDU Protocol Data Unit

R Required (Key Attribute)

RIS Radiology Information System

SC Secondary Capture

SCP Service Class Provider

SCU Service Class User

SOP Service-Object Pair

SPS Scheduled Procedure Step

SR Structured Reporting

TCP/IP Transmission Control Protocol/Internet Protocol

U Unique (Key Attribute)

UL Upper Layer

US Ultrasound

VR Value Representation

2. NETWORK CONFORMANCE STATEMENT

2.1 INTRODUCTION

This section of the DICOM Conformance Statement specifies the compliance to DICOM conformance requirements for the relevant **Networking** features for Vivid version 203. Note that the format of this section strictly follows the format defined in DICOM Standard PS 3.2 (Conformance). Please refer to that part of the standard while reading this section.

Vivid v203 is an Ultrasound scanner running on a commercial computer. It allows for the following DICOM functionality:

- Sending and receiving Echo messages to and from DICOM Verification SCP and client.
- Exporting DICOM images and results to a DICOM SCP or saving the DICOM images and results to DICOM media format.
- Browsing and viewing DICOM images on DICOM media format.
- Querying and retrieving DICOM Modality Worklist from a Worklist SCP.
- Sending start and end of examination to a DICOM Modality Performed Procedure Step SCP.
- Sending storage commitment requests (and receiving replies) to a DICOM Storage Commitment SCP.
- Printing images to a DICOM Printer.
- Querying and retrieving examinations from a DICOM Query/Retrieve SCP.

2.2 IMPLEMENTATION MODEL

2.2.1 Application Data Flow Diagram

The Basic and Specific Application models for this device are shown in the following illustration:

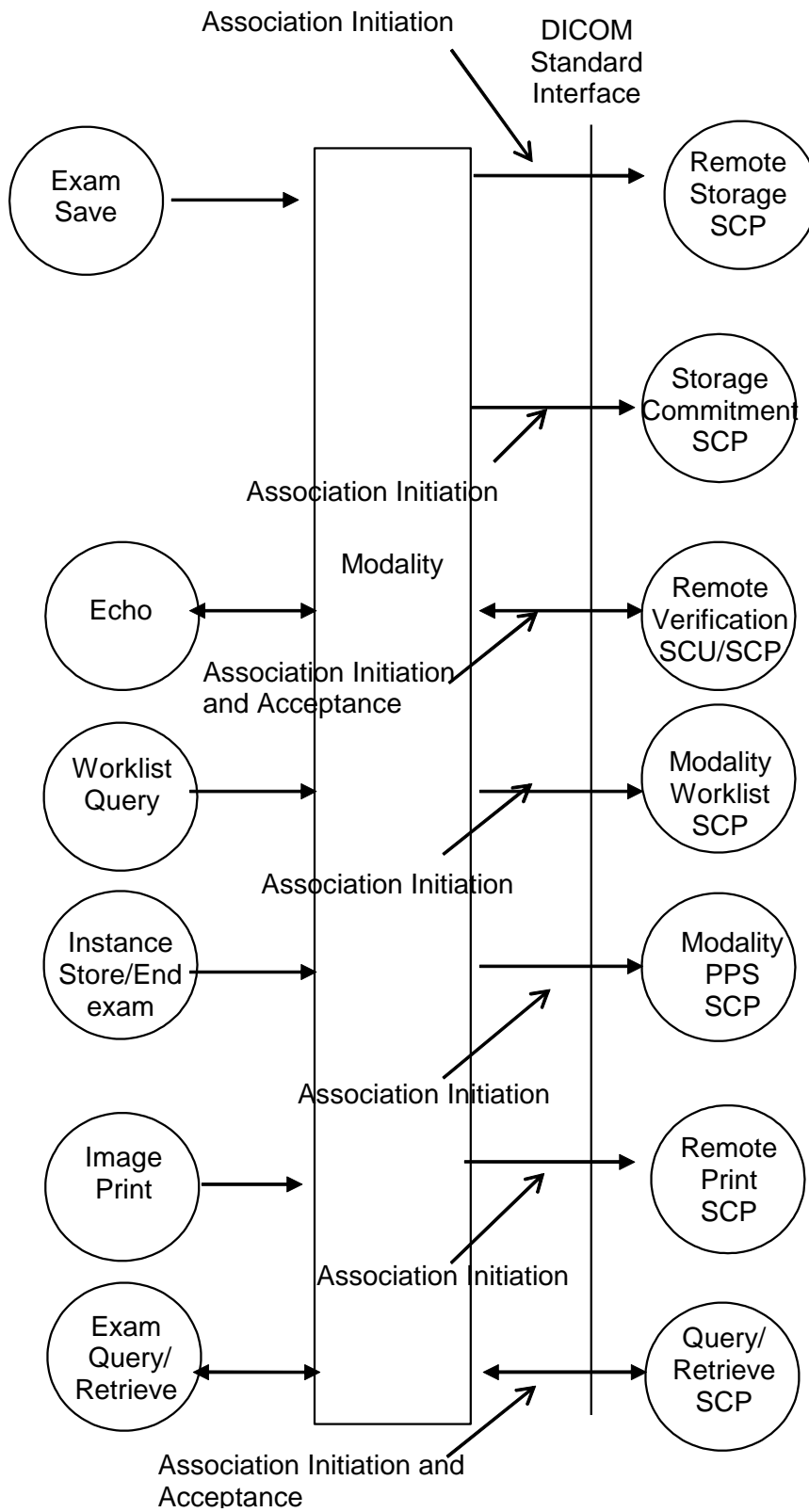

There are six local real-world activities that occur in Vivid v203 – **Exam Save, Echo, Worklist Query, Image Store/End Exam, Image Print** and **Exam Query/Retrieve**

Exam save initiates a connection with the DICOM SCP and transmits images and results to the DICOM SCP. If Storage Commitment is configured a commitment request will be sent for the images and results.

Echo initiates a connection with the DICOM SCP, posts a Verification request and closes the connection. It also responds to incoming Verification requests (for service use).

Worklist Query initiates a connection with the DICOM SCP, performs a query and retrieves the matching entries to the product.

Image Store/End exam: If Modality Performed Procedure Step is configured N-CREATE and N-SET messages will be sent for the exam.

Image Print will send images to a DICOM Print SCP.

Exam Query/Retrieve initiates a connection with the DICOM SCP, performs a query and retrieves selected examination.

2.2.2 Functional Definition of AE's

Application Entity Vivid v203 supports the following functions:

- Initiates a DICOM association to send images and results.
- Transmits DICOM images and results to the DICOM Storage SCP.
- Initiates a DICOM verification to assist in network diagnostics.
- Responds to DICOM verification requests from other devices.
- Initiates a DICOM worklist query to receive worklist information.
- Initiates a DICOM association to notify start of examination.
- Initiates a DICOM association to notify end of examination.
- Initiates a DICOM association to request storage commitment of images.
- Responds to replies for storage commitment requests of images.
- Initiates a DICOM association to print images.
- Initiates a DICOM association to query for and retrieve examinations.
- Responds to storage requests triggered by examination retrieve requests.

2.2.3 Sequencing of Real-World Activities

Not applicable.

2.3 AE SPECIFICATIONS

2.3.1 Vivid v203 AE Specification

This Application Entity provides Standard Conformance to the following DICOM SOP Classes as an SCU:

SOP Class Name	SOP Class UID
Ultrasound Multi-frame Image Storage	1.2.840.10008.5.1.4.1.1.3.1
Ultrasound Multi-frame Image Storage (Retired)	1.2.840.10008.5.1.4.1.1.3
Ultrasound Image Storage	1.2.840.10008.5.1.4.1.1.6.1
Ultrasound Image Storage (Retired)	1.2.840.10008.5.1.4.1.1.6
Secondary Capture Image Storage	1.2.840.10008.5.1.4.1.1.7
Verification SOP Class	1.2.840.10008.1.1
Modality Worklist Information Model – FIND	1.2.840.10008.5.1.4.31
Modality Performed Procedure Step SOP Class	1.2.840.10008.3.1.2.3.3
Storage Commitment Push Model SOP Class	1.2.840.10008.1.20.1
Basic Grayscale Print Management Meta SOP Class	1.2.840.10008.5.1.1.9
Basic Color Print Management Meta SOP Class	1.2.840.10008.5.1.1.18
Study Root Query/Retrieve Information Model – FIND	1.2.840.10008.5.1.4.1.2.2.1
Study Root Query/Retrieve Information Model – MOVE	1.2.840.10008.5.1.4.1.2.2.2
Comprehensive Structured Report Storage	1.2.840.10008.5.1.4.1.1.88.33

This Application Entity provides Standard Conformance to the following DICOM SOP Classes as an SCP:

SOP Class Name	SOP Class UID
Ultrasound Multi-frame Image Storage	1.2.840.10008.5.1.4.1.1.3.1
Ultrasound Multi-frame Image Storage (Retired)	1.2.840.10008.5.1.4.1.1.3
Ultrasound Image Storage	1.2.840.10008.5.1.4.1.1.6.1
Ultrasound Image Storage (Retired)	1.2.840.10008.5.1.4.1.1.6
Secondary Capture Image Storage	1.2.840.10008.5.1.4.1.1.7
CT Image Storage	1.2.840.10008.5.1.4.1.1.2
Enhanced CT Image Storage	1.2.840.10008.5.1.4.1.1.2.1
Verification SOP Class	1.2.840.10008.1.1

2.3.1.1 Association Establishment Policies**2.3.1.1.1 General**

The DICOM Application Context Name (ACN), which is always proposed, is:

Application Context Name	1.2.840.10008.3.1.1.1
---------------------------------	------------------------------

The Maximum Length PDU negotiation is included in all association establishment requests. The maximum length PDU for an association initiated by Vivid v203 is (not configurable):

Maximum Length PDU	32768
---------------------------	--------------

The SOP Class Extended Negotiation is not supported.

The user information Items sent by this product are:

- Maximum PDU Length
- Implementation UID
- Implementation Version Name

2.3.1.1.2 Number of Associations

The Vivid v203 AE will initiate multiple DICOM associations. Maximum number of simultaneous associations is 2.

2.3.1.1.3 Asynchronous Nature

Asynchronous mode is not supported. All operations will be performed synchronously.

2.3.1.1.4 Implementation Identifying Information

The Implementation UID for this DICOM Implementation is:

Vivid E95 Implementation UID	1.2.840.113619.6.391
Vivid E90 Implementation UID	1.2.840.113619.6.390
Vivid E80 Implementation UID	1.2.840.113619.6.392
Vivid S70N Implementation UID	1.2.840.113619.6.394
Vivid S60N Implementation UID	1.2.840.113619.6.393
Vivid iq Implementation UID	1.2.840.113619.6.435
Vivid T8 Implementation UID	1.2.840.113619.6.400

Vivid T9 Implementation UID	1.2.840.113619.6.460
-----------------------------	----------------------

The Implementation Version Name for this DICOM Implementation is:

Vivid E95 Implementation Version Name	VIVIDE95_203
Vivid E90 Implementation Version Name	VIVIDE90_203
Vivid E80 Implementation Version Name	VIVIDE80_203
Vivid S70N Implementation Version Name	VIVIDS70_203
Vivid S60N Implementation Version Name	VIVIDS60_203
Vivid iq Implementation Version Name	VIVIDIQ_203
Vivid T8 Implementation Version Name	VIVIDT8_203
Vivid T9 Implementation Version Name	VIVIDT9_203

Note: The Implementation Version Name may change in the future without modification of this document.

2.3.1.2 Association Initiation Policy

The Vivid v203 AE attempts to establish a new association with a remote device due to six Real-World Activities:

- Exam save initiated by the operator for images and results and sending request for Storage Commitment.
- Verification, which verifies application level communication between peer DICOM AE’s for service purposes.
- Worklist initiated by the operator for receiving worklist information.
- Image Store/End Exam sending messages to Modality Performed Procedure Step.
- Print initiated by the operator for a specific image or group of images.
- Exam Query/Retrieve initiated by the operator for receiving examination information and selecting examination to retrieve.

2.3.1.2.1 Real-World Activity A (‘Exam save’ Operation)

2.3.1.2.1.1 Associated Real-World Activity

Upon a request by the operator (manual or automatic), images will be sent to a DICOM Storage SCP.

2.3.1.2.1.2 Proposed Presentation Context Tables

The Proposed Presentation Context Table depends on compression (configurable) according to the following table:

Presentation Context Table – Proposed					
Abstract Syntax		Transfer Syntax		Role	Extended Negotiation
Name	UID	Name List	UID List		

Presentation Context Table: Compression set to None					
Secondary Capture Image Storage	1.2.840.10008.5.1.4.1.1.7	Explicit VR Little Endian Explicit VR Big Endian Implicit VR Little Endian	1.2.840.10008.1.2.1 1.2.840.10008.1.2.2 1.2.840.10008.1.2	SCU	None
Ultrasound Image Storage	1.2.840.10008.5.1.4.1.1.6.1	Explicit VR Little Endian Explicit VR Big Endian Implicit VR Little Endian	1.2.840.10008.1.2.1 1.2.840.10008.1.2.2 1.2.840.10008.1.2	SCU	None
Ultrasound Multi-frame Image Storage	1.2.840.10008.5.1.4.1.1.3.1	Explicit VR Little Endian Explicit VR Big Endian Implicit VR Little Endian	1.2.840.10008.1.2.1 1.2.840.10008.1.2.2 1.2.840.10008.1.2	SCU	None
Ultrasound Image Storage (retired)	1.2.840.10008.5.1.4.1.1.6	Explicit VR Little Endian Explicit VR Big Endian Implicit VR Little Endian	1.2.840.10008.1.2.1 1.2.840.10008.1.2.2 1.2.840.10008.1.2	SCU	None
Ultrasound Multi-frame Image Storage (retired)	1.2.840.10008.5.1.4.1.1.3	Explicit VR Little Endian Explicit VR Big Endian Implicit VR Little Endian	1.2.840.10008.1.2.1 1.2.840.10008.1.2.2 1.2.840.10008.1.2	SCU	None
Presentation Context Table: Compression set to RLE					
Secondary Capture Image Storage	1.2.840.10008.5.1.4.1.1.7	Run Length Encoding, RLE Explicit VR Little Endian Explicit VR Big Endian Implicit VR Little Endian	1.2.840.10008.1.2.5 1.2.840.10008.1.2.1 1.2.840.10008.1.2.2 1.2.840.10008.1.2	SCU	None
Ultrasound Image Storage	1.2.840.10008.5.1.4.1.1.6.1	Run Length Encoding, RLE Explicit VR Little Endian Explicit VR Big Endian Implicit VR Little Endian	1.2.840.10008.1.2.5 1.2.840.10008.1.2.1 1.2.840.10008.1.2.2 1.2.840.10008.1.2	SCU	None
Ultrasound Multi-frame Image Storage	1.2.840.10008.5.1.4.1.1.3.1	Run Length Encoding, RLE Explicit VR Little Endian Explicit VR Big Endian Implicit VR Little Endian	1.2.840.10008.1.2.5 1.2.840.10008.1.2.1 1.2.840.10008.1.2.2 1.2.840.10008.1.2	SCU	None
Ultrasound Image Storage (retired)	1.2.840.10008.5.1.4.1.1.6	Run Length Encoding, RLE Explicit VR Little Endian Explicit VR Big Endian Implicit VR Little Endian	1.2.840.10008.1.2.5 1.2.840.10008.1.2.1 1.2.840.10008.1.2.2 1.2.840.10008.1.2	SCU	None
Ultrasound Multi-frame Image Storage (retired)	1.2.840.10008.5.1.4.1.1.3	Run Length Encoding, RLE Explicit VR Little Endian Explicit VR Big Endian Implicit VR Little Endian	1.2.840.10008.1.2.5 1.2.840.10008.1.2.1 1.2.840.10008.1.2.2 1.2.840.10008.1.2	SCU	None
Presentation Context Table: Compression set to JPEG					
Secondary Capture Image Storage	1.2.840.10008.5.1.4.1.1.7	JPEG Baseline coding Process 1	1.2.840.10008.1.2.4.5 0	SCU	None
Ultrasound Image Storage	1.2.840.10008.5.1.4.1.1.6.1	JPEG Baseline coding Process 1	1.2.840.10008.1.2.4.5 0	SCU	None
Ultrasound Multi-frame Image Storage	1.2.840.10008.5.1.4.1.1.3.1	JPEG Baseline coding Process 1	1.2.840.10008.1.2.4.5 0	SCU	None
Ultrasound Image Storage	1.2.840.10008.5.1.4.1.1.6	JPEG Baseline coding Process 1	1.2.840.10008.1.2.4.5 0	SCU	None
Ultrasound Multi-frame Image Storage (retired)	1.2.840.10008.5.1.4.1.1.3	JPEG Baseline coding Process 1	1.2.840.10008.1.2.4.5 0	SCU	None
Presentation Context Table for Structured Reports					

Comprehensive Structured Report	1.2.840.10008.5.1.4.1.1.88.33	Explicit VR Little Endian Explicit VR Big Endian Implicit VR Little Endian	1.2.840.10008.1.2.1 1.2.840.10008.1.2.2 1.2.840.10008.1.2	SCU	None
---------------------------------	-------------------------------	--	---	-----	------

This operation also sends a Storage Commitment Request, with the following proposed presentation context. The result from the SCP is expected on another association for the Storage Commitment result.

Presentation Context Table Proposed					
Abstract Syntax		Transfer Syntax		Role	Extended Negotiation
Name	UID	Name List	UID List		
Storage Commitment Push Model SOP Class	1.2.840.10008.1.20.1	Explicit VR Little Endian Explicit VR Big Endian Implicit VR Little Endian	1.2.840.10008.1.2.1 1.2.840.10008.1.2.2 1.2.840.10008.1.2	SCU	None

2.3.1.2.1.2.1 SOP Specific DICOM Conformance Statement for all Storage and Storage Commitment SOP Classes

For these SOP classes (Storage and Storage Commitment), all status codes with status Refused or Error are treated as failures and terminate the association and operation. On a failure, the request will be put in a holding queue for the user to manually retry the request. All status codes with status Warning or Success are treated as successes.

2.3.1.2.2 Real-World Activity B ('Echo' Operation)

2.3.1.2.2.1 Associated Real-World Activity

The user may initiate a DICOM Verification Request in the Config screen.

Associations will be released upon the receipt of each C-ECHO confirmation.

In the event that the SCP does not respond, the operation will time out, close the association and inform the user.

2.3.1.2.2.2 Proposed Presentation Context Table

Presentation Context Table – Proposed					
Abstract Syntax		Transfer Syntax		Role	Extended Negotiation
Name	UID	Name List	UID List		
Verification SOP Class	1.2.840.10008.1.1	Explicit VR Little Endian Explicit VR Big Endian Implicit VR Little Endian	1.2.840.10008.1.2.1 1.2.840.10008.1.2.2 1.2.840.10008.1.2	SCU	None

2.3.1.2.3 Real-World Activity C ('Worklist Query' Operation)**2.3.1.2.3.1 Associated Real-World Activity**

The user may initiate a DICOM Worklist Query in Search screen, which will send a C-FIND-RQ to the Worklist SCP.

Associations will be released upon the receipt of C-FIND-RSP confirmation.

2.3.1.2.3.2 Proposed Presentation Context Tables

Presentation Context Table – Proposed					
Abstract Syntax		Transfer Syntax		Role	Extended Negotiation
Name	UID	Name List	UID List		
Modality Worklist Information Model – FIND	1.2.840.10008.5.1.4.31	Explicit VR Little Endian	1.2.840.10008.1.2.1	SCU	None
		Explicit VR Big Endian	1.2.840.10008.1.2.2		
		Implicit VR Little Endian	1.2.840.10008.1.2		

2.3.1.2.3.2.1 SOP Specific DICOM Conformance Statement for Worklist SOP Classes

All status codes with status Refused or Error are treated as failures and terminate the association and operation. On a failure, the user will be informed and the last successful query will be used as Worklist. All status codes with status Warning or Success are treated as successes.

See 9.5 for the list of Matching keys used for Worklist.

2.3.1.2.4 Real-World Activity D ('Image Store/End exam' Operation)**2.3.1.2.4.1 Associated Real-World Activity**

The Modality Performed Procedure Step messages are sent when the first image or result is made for an exam and when the exam is ended (for the case where there are no images or results, the N-CREATE is sent when the exam is ended). For an exam with saved images or results, the N-SET will be sent with status COMPLETED. For an exam without saved images or results, the N-SET will be sent with status DISCONTINUED.

2.3.1.2.4.2 Proposed Presentation Context Table

Presentation Context Table – Proposed					
Abstract Syntax		Transfer Syntax		Role	Extended Negotiation
Name	UID	Name List	UID List		
Modality Performed Procedure Step SOP Class	1.2.840.10008.3.1.2.3.3	Explicit VR Little Endian	1.2.840.10008.1.2.1	SCU	None
		Explicit VR Big Endian	1.2.840.10008.1.2.2		
		Implicit VR Little Endian	1.2.840.10008.1.2		

2.3.1.2.4.2.1 SOP Specific DICOM Conformance Statement for Modality Performed Procedure Step Class

For this SOP class, all status codes with status Refused or Error are treated as failures and terminate the association and operation. All status codes with status Warning or Success are treated as successes.

The Vivid v203 AE includes attributes in the Modality Performed Procedure Step N-CREATE and N-SET as described in Section 10.2. The mapping from Worklist attributes is described in Section 9.5.

2.3.1.2.5 Real-World Activity E ('Image Print' Operation)**2.3.1.2.5.1 Associated Real-World Activity**

Upon a request by the operator, print jobs will be sent to a DICOM Print SCP. If an error occurs during the transmission, the current association is released and a new association initiated. The maximum number of retries is configurable.

2.3.1.2.5.2 Proposed Presentation Context Tables

The following table is used:

Presentation Context Table – Proposed					
Abstract Syntax		Transfer Syntax		Role	Extended Negotiation
Name	UID	Name List	UID List		
Basic Grayscale Print Management Meta SOP Class	1.2.840.10008.5.1.1.9	Explicit VR Little Endian	1.2.840.10008.1.2.1	SCU	None
		Explicit VR Big Endian	1.2.840.10008.1.2.2		
		Implicit VR Little Endian	1.2.840.10008.1.2		
Basic Color Print Management Meta SOP Class	1.2.840.10008.5.1.1.18	Explicit VR Little Endian	1.2.840.10008.1.2.1	SCU	None
		Explicit VR Big Endian	1.2.840.10008.1.2.2		
		Implicit VR Little Endian	1.2.840.10008.1.2		

2.3.1.2.5.2.1 SOP Specific DICOM Conformance Statement for all Print Management SOP Classes

All status codes with status Refused or Error are treated as failures and terminate the association and operation. All status codes with status Warning or Success are treated as successes.

2.3.1.2.6 Real-World Activity F ('Exam Query/Retrieve' Operation)**2.3.1.2.6.1 Associated Real-World Activity**

The user may initiate a DICOM Exam Query in Search screen, which will send a C-FIND-RQ to the Query/Retrieve SCP.

Associations will be released upon the receipt of C-FIND-RSP confirmation.

The user may then select an examination to be retrieved, using the C-MOVE-RQ command to the Query/Retrieve SCP. The result from the SCP is expected on another association for the retrieved examinations.

2.3.1.2.6.2 Proposed Presentation Context Tables

Presentation Context Table – Proposed					
Abstract Syntax		Transfer Syntax		Role	Extended Negotiation
Name	UID	Name List	UID List		
Study Root Query/Retrieve Information Model – FIND	1.2.840.10008.5.1.4.1.2.2.1	Explicit VR Little Endian	1.2.840.10008.1.2.1	SCU	None
		Explicit VR Big Endian	1.2.840.10008.1.2.2		
		Implicit VR Little Endian	1.2.840.10008.1.2		
Study Root Query/Retrieve Information Model – MOVE	1.2.840.10008.5.1.4.1.2.2.2	Explicit VR Little Endian	1.2.840.10008.1.2.1	SCU	None
		Explicit VR Big Endian	1.2.840.10008.1.2.2		
		Implicit VR Little Endian	1.2.840.10008.1.2		

2.3.1.2.6.2.1 SOP Specific DICOM Conformance Statement for Study Root Query/Retrieve Information Model – FIND SOP Classes

All status codes with status Refused or Error are treated as failures and terminate the association and operation. All status codes with status Warning or Success are treated as successes.

Vivid v203 will only support hierarchical query.

2.3.1.2.6.2.2 SOP Specific DICOM Conformance Statement for Study Root Query/Retrieve Information Model – MOVE SOP Classes

All status codes with status Refused or Error are treated as failures and terminate the association and operation. All status codes with status Warning or Success are treated as successes.

2.3.1.3 Association Acceptance Policy

The AE accepts an association when Vivid v203 receives an N-EVENT-REPORT from a Storage Commitment request, a Verification Request from another network device or a C-STORE request as part of a Query/Retrieve operation.

2.3.1.3.1 Real-World Activity A – ('Exam Save' operation)

2.3.1.3.1.1 Associated Real-World Activity

An incoming N-EVENT-REPORT will cause the AE to accept the association (using SCP/SCU Role Negotiation) and update the internal Storage Commitment statuses.

2.3.1.3.1.2 Accepted Presentation Context Table

Presentation Context Table Accepted					
Abstract Syntax		Transfer Syntax		Role	Extended Negotiation
Name	UID	Name List	UID List		
Storage Commitment Push Model SOP Class	1.2.840.10008.1.20.1	Explicit VR Little Endian Explicit VR Big Endian Implicit VR Little Endian	1.2.840.10008.1.2.1 1.2.840.10008.1.2.2 1.2.840.10008.1.2	SCU	None

2.3.1.3.1.2.1 SOP Specific DICOM Conformance Statement for Storage Commitment SOP Class

The AE provides standard conformance to the Storage Commitment SOP Class as an SCP for the N-EVENT-REPORT. The default port number is 104.

2.3.1.3.1.3 Presentation Context Acceptance Criterion

No criterion.

2.3.1.3.1.4 Transfer Syntax Selection Policies

The selected transfer syntax is based on the proposed transfer syntax list. The priority order is Explicit VR Little Endian, Explicit VR Big Endian and Implicit VR Little Endian.

2.3.1.3.2 Real-World Activity B – ('Echo' operation)**2.3.1.3.2.1 Associated Real-World Activity**

An incoming Verification Request will cause the AE to accept the association and respond with a Verification Response.

2.3.1.3.2.2 Accepted Presentation Context Table

Presentation Context Table – Accepted					
Abstract Syntax		Transfer Syntax		Role	Extended Negotiation
Name	UID	Name List	UID List		
Verification SOP Class	1.2.840.10008.1.1	Explicit VR Little Endian	1.2.840.10008.1.2.1	SCP	None
		Explicit VR Big Endian	1.2.840.10008.1.2.2		
		Implicit VR Little Endian	1.2.840.10008.1.2		

2.3.1.3.2.2.1 SOP Specific DICOM Conformance Statement for Verify SOP Class

The AE provides standard conformance to the Verification SOP Class as an SCP. The default port number is 104.

2.3.1.3.2.3 Presentation Context Acceptance Criterion

No criterion.

2.3.1.3.2.4 Transfer Syntax Selection Policies

The selected transfer syntax is based on the proposed transfer syntax list. The priority order is Explicit VR Little Endian, Explicit VR Big Endian and Implicit VR Little Endian.

2.3.1.3.3 Real-World Activity F ('Exam Query/Retrieve' Operation)**2.3.1.3.3.1 Associated Real-World Activity**

If the user has initiated a retrieve by a C-MOVE-RQ, the AE will accept associations for C-STORE-RQs. The images will be stored locally.

2.3.1.3.3.2 Accepted Presentation Context Table

Presentation Context Table – Accepted					
Abstract Syntax		Transfer Syntax		Role	Extended Negotiation
Name	UID	Name List	UID List		
Ultrasound Image Storage	1.2.840.10008.5.1.4.1.1.6.1	JPEG Baseline coding Process 1	1.2.840.10008.1.2.4.50	SCP	None
		Explicit VR Little Endian	1.2.840.10008.1.2.1		
		Explicit VR Big Endian	1.2.840.10008.1.2.2		
		Implicit VR Little Endian	1.2.840.10008.1.2		
		Run Length Encoding, RLE	1.2.840.10008.1.2.5		

Ultrasound Multi-frame Image Storage	1.2.840.10008.5.1.4.1.1.3.1	JPEG Baseline coding Process 1 Explicit VR Little Endian Explicit VR Big Endian Implicit VR Little Endian Run Length Encoding, RLE	1.2.840.10008.1.2.4.50 1.2.840.10008.1.2.1 1.2.840.10008.1.2.2 1.2.840.10008.1.2 1.2.840.10008.1.2.5	SCP	None
Ultrasound Image Storage (retired)	1.2.840.10008.5.1.4.1.1.6	JPEG Baseline coding Process 1 Explicit VR Little Endian Explicit VR Big Endian Implicit VR Little Endian Run Length Encoding, RLE	1.2.840.10008.1.2.4.50 1.2.840.10008.1.2.1 1.2.840.10008.1.2.2 1.2.840.10008.1.2 1.2.840.10008.1.2.5	SCP	None
Ultrasound Multi-frame Image Storage (retired)	1.2.840.10008.5.1.4.1.1.3	JPEG Baseline coding Process 1 Explicit VR Little Endian Explicit VR Big Endian Implicit VR Little Endian Run Length Encoding, RLE	1.2.840.10008.1.2.4.50 1.2.840.10008.1.2.1 1.2.840.10008.1.2.2 1.2.840.10008.1.2 1.2.840.10008.1.2.5	SCP	None
Secondary Capture Image Storage	1.2.840.10008.5.1.4.1.1.7	JPEG Baseline coding Process 1 Explicit VR Little Endian Explicit VR Big Endian Implicit VR Little Endian Run Length Encoding, RLE	1.2.840.10008.1.2.4.50 1.2.840.10008.1.2.1 1.2.840.10008.1.2.2 1.2.840.10008.1.2 1.2.840.10008.1.2.5	SCP	None
CT Image Storage	1.2.840.10008.5.1.4.1.1.2	Implicit VR Little Endian Explicit VR Little Endian	1.2.840.10008.1.2 1.2.840.10008.1.2.1	SCP	None
Enhanced CT Image Storage	1.2.840.10008.5.1.4.1.1.2.1	Implicit VR Little Endian Explicit VR Little Endian	1.2.840.10008.1.2 1.2.840.10008.1.2.1	SCP	None

2.3.1.3.3.2.1 SOP Specific DICOM Conformance Statement for Storage SOP Classes

The AE provides standard conformance to the Storage SOP Classes as an SCP. The default port number is 104.

2.3.1.3.3.3 Presentation Context Acceptance Criterion

No criterion.

2.3.1.3.3.4 Transfer Syntax Selection Policies

The selected transfer syntax is based on the proposed transfer syntax list. The priority order is JPEG Baseline, Run Length Encoding RLE, Explicit VR Little Endian, Explicit VR Big Endian and Implicit VR Little Endian.

2.4 COMMUNICATION PROFILES

2.4.1 Supported Communication Stacks (PS 3.8, PS 3.9)

DICOM Upper Layer (PS 3.8) is supported using TCP/IP.

2.4.2 TCP/IP Stack

The TCP/IP stack is inherited from the product's operating system. Please refer to product documentation for more information.

2.4.2.1 API

Not applicable to this product.

2.4.3 Additional Protocols

The ability to enable and use DHCP as a client is inherited from the product's operating system. Please refer to product documentation for more information.

The ability to enable and use DNS as a client is inherited from the product's operating system. Please refer to product documentation for more information. Note: The product does not support configuration of the SCP only by hostname. The SCP must be specified by AE Title, IP address (together with an associated name) and port number (see 2.6).

2.4.4 IPv4 and IPv6 Support

The product does only support IPv4.

2.5 EXTENSIONS / SPECIALIZATIONS / PRIVATIZATIONS

If so configured, the product will send ultrasound raw data information in private data elements designated by the Private Creator element:

Element Name	Tag	VR	VM	Description
Private Creator	7FE1,00xx	LO	1	GEMS_Ultrasound_MovieGroup_001

This means that all private tags starting with 7FE1,xx will belong to the GEMS_Ultrasound_MovieGroup_001.

If so configured, the product will send preview image in private data elements designated by the Private Creator element:

Element Name	Tag	VR	VM	Description
Private Creator	6003,00xx	LO	1	GEMS_Ultrasound_ImageGroup_001

This means that all private tags starting with 6003,xx will belong to the GEMS_Ultrasound_ImageGroup_001.

If so configured, the product will send exam information in private data elements designated by the Private Creator element:

Element Name	Tag	VR	VM	Description
--------------	-----	----	----	-------------

Private Creator	6005,00xx	LO	1	GEMS_Ultrasound_ExamGroup_001
-----------------	-----------	----	---	-------------------------------

This means that all private tags starting with 6005,xx will belong to the GEMS_Ultrasound_ExamGroup_001.

2.6 CONFIGURATION

2.6.1 AE Title/Presentation Address Mapping

The Local AE title is configurable through the Config screen, see below.

2.6.2 Configurable Parameters

Network:

- Local IP address
- Local port number (default 104)
- Local IP netmask
- Local routing table information

Local:

- Local AE Title

Verification:

- The AE Title, IP address and port number of the SCP
- Max retries, Retry interval, Timeout

Modality Worklist:

- The AE Title, IP address and port number of the SCP
- Max retries, Retry interval, Timeout
- Disabling/enabling and setting constant values for query fields
- Maximum number of downloaded entries

Storage:

- The AE Title, IP address and port number of the SCP
- Max retries, Retry interval, Timeout
- Enable/disable raw data
- Frame rate reduction
- Enable/disable multi-frame
- Compression selections
- Color support
- Association strategies: one association per image or one association per exam
- Enable/disable results (SR).
- Enable/disable private data elements in results (SR).
- Enable/disable “Signed Doppler Velocities” in results (SR).
- Enable/disable “Use older SR version”.
- Selection of SR version (when “Use older SR version” is enabled).

Modality Performed Procedure Step:

- The AE Title, IP address and port number of the SCP
- Max retries, Retry interval, Timeout

Storage Commitment:

- The AE Title, IP address and port number of the SCP
- Max retries, Retry interval, Timeout

Print:

- The AE Title, IP address and port number of the SCP
- Max retries, Retry interval, Timeout
- Configuration for each job according to attribute description in Section 12 of this document.

Query/Retrieve:

- The AE Title, IP address and port number of the SCP
- Max retries, Retry interval, Timeout
- Disabling/enabling and setting constant values for query fields
- Maximum number of downloaded entries

2.7 SUPPORT OF EXTENDED CHARACTER SETS

Vivid v203 will support the ISO_IR 100 (ISO 8859-1:1987 Latin alphabet N 1. supplementary set) as extended character set. Any incoming SOP instance that is encoded using another extended character set will not be displayed.

2.8 CODES AND CONTROLLED TERMINOLOGY**2.8.1 Fixed Coded Terminology**

The product uses the fixed (non-configurable, non-extensible) coded terminology in SR Document attributes, as described in Section 7 SR INFORMATION OBJECT IMPLEMENTATION.

2.9 SECURITY PROFILES

The product does not conform to any defined DICOM Security Profiles.

It is assumed that the product is used within a secured environment. It is assumed that a secured environment includes at a minimum:

1. Firewall or router protections to ensure that only approved external hosts have network access to the product.
2. Firewall or router protections to ensure that the product only has network access to approved external hosts and services.
3. Any communications with external hosts and services outside the locally secured environment use appropriate secure network channels (such as a Virtual Private Network(VPN))

3. MEDIA STORAGE CONFORMANCE STATEMENT

3.1 INTRODUCTION

This section of the conformance statement (CS) specifies the Vivid v203 compliance to DICOM Media Interchange. It details the DICOM Media Storage Application Profiles and roles, which are supported by this product.

Vivid v203 is able to export images and results to DICOM media, browse DICOM media or read images from DICOM media.

3.2 IMPLEMENTATION MODEL

3.2.1 Application Data Flow Diagram

The Basic and Specific Application models for this device are shown in the following Illustration:

ILLUSTRATION 3-1
SPECIFIC AE APPLICATION MODEL

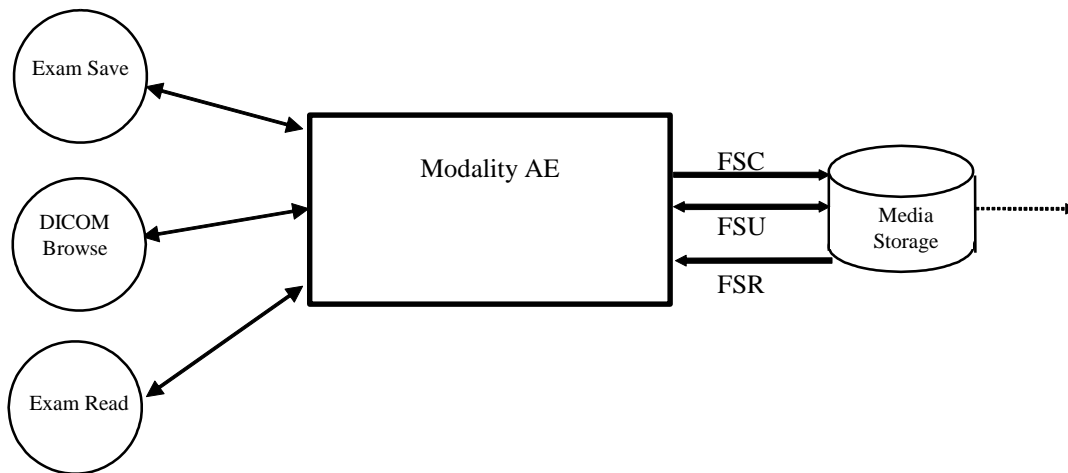

Vivid v203 can initialize Media by acting as an FSC to create a new DICOM File-set on Media as stated in 3.3.1. The SOP instances written to media must be one of the instances supported by Vivid v203. A pre-existing File-set will be updated with the information in DICOM files copied to media.

3.2.2 Functional Definition of AE's

Vivid v203 can perform these functions:

- Create a new DICOM File-set on media

- Update DICOM File-set by adding new SOP instances to the File-set
- Read information and images from the existing File-set

3.2.3 Sequencing Requirements

None applicable

3.2.4 File Meta Information Options (See PS3.10)

The File Meta-Information for the v203 implementations are:

File Meta-Information Version	1
Vivid E95 Implementation UID	1.2.840.113619.6.391
Vivid E90 Implementation UID	1.2.840.113619.6.390
Vivid E80 Implementation UID	1.2.840.113619.6.392
Vivid S70N Implementation UID	1.2.840.113619.6.394
Vivid S60N Implementation UID	1.2.840.113619.6.393
Vivid iq Implementation UID	1.2.840.113619.6.435
Vivid T8 Implementation UID	1.2.840.113619.6.400
Vivid T9 Implementation UID	1.2.840.113619.6.460
Implementation Version Name	
Vivid E95 Implementation Version Name	VIVIDE95_203
Vivid E90 Implementation Version Name	VIVIDE90_203
Vivid E80 Implementation Version Name	VIVIDE80_203
Vivid S70N Implementation Version Name	VIVIDS70_203
Vivid S60N Implementation Version Name	VIVIDS60_203
Vivid iq Implementation Version Name	VIVIDIQ_203
Vivid T8 Implementation Version Name	VIVIDT8_203
Vivid T9 Implementation Version Name	VIVIDT9_203

Note: The Implementation Version Name and may change in the future without modification of this document.

3.3 AE SPECIFICATIONS

3.3.1 Vivid v203 AE Specification

The Vivid v203 Application Entity provides standard conformance to DICOM Interchange Option of the Media Storage Service Class. The Application Profiles and roles are listed below; the standard profiles are augmented with Secondary Capture images and SRs. Note that in one case (see 4.5.7.1 US Region Calibration Module), the multi-frame image will be sent without region calibration (i.e. AUG-US-ID-MF-XXX).

Supported Application Profile	Real World Activity	Role	Description
AUG-US-SC-SF-CDR, AUG-US-SC-MF-CDR, AUG-US-SC-SF-DVD, AUG-US-SC-MF-DVD	Exam save	FSR/ FSC	Interchange
	Browse	FSR	Interchange
	Exam Read	FSR	Interchange

3.3.1.1 File Meta Information for the Vivid v203 Application Entity

The Source Application Entity is set from the Vivid v203 local AE title. The local AE is configurable.

Following are the default values set in the File Meta Information for the AE Title for each Vivid model:

Vivid E95 Source Application Entity Title	VIVIDE95_203
Vivid E90 Source Application Entity Title	VIVIDE90_203
Vivid E80 Source Application Entity Title	VIVIDE80_203
Vivid S70N Source Application Entity Title	VIVIDS70_203
Vivid S60N Source Application Entity Title	VIVIDS60_203
Vivid iq Source Application Entity Title	VIVIDIQ_203
Vivid T8 Source Application Entity Title	VIVIDT8_203
Vivid T9 Source Application Entity Title	VIVIDT9_203

3.3.1.2 Real-World Activities for the Vivid v203 Application Entity

3.3.1.2.1 Real-World Activity “Exam save”

“Exam save” saves a DICOM SOP instance to media and updates DICOM File Set.

3.3.1.2.1.1 Media Storage Application Profile for the Real-World Activity “Exam save”:

For the list of Application Profiles that invoke this AE for “Exam save” Real-World Activity, see the Table in Section 3.3.1 “Vivid v203 AE Specification” where the table describing the profiles and real-world activities is defined.

3.3.1.2.1.1.1 Options

Following are the SOP Classes supported by the Real-World Activity “Exam save”:

Information Object Definition	SOP Class UID	Transfer Syntax	Transfer Syntax UID
-------------------------------	---------------	-----------------	---------------------

DICOM Media Storage Directory	1.2.840.10008.1.3.10	Explicit VR Little Endian	1.2.840.10008.1.2.1
Ultrasound Multi-frame Image Storage	1.2.840.10008.5.1.4.1.1.3.1	Explicit VR Little Endian Run Length Encoding, RLE JPEG Baseline	1.2.840.10008.1.2.1 1.2.840.10008.1.2.5 1.2.840.10008.1.2.4.50
Ultrasound Image Storage	1.2.840.10008.5.1.4.1.1.6.1	Explicit VR Little Endian Run Length Encoding, RLE JPEG Baseline	1.2.840.10008.1.2.1 1.2.840.10008.1.2.5 1.2.840.10008.1.2.4.50
Secondary Capture Image Storage	1.2.840.10008.5.1.4.1.1.7	Explicit VR Little Endian Run Length Encoding, RLE JPEG Baseline	1.2.840.10008.1.2.1 1.2.840.10008.1.2.5 1.2.840.10008.1.2.4.50
Comprehensive Structured Report	1.2.840.10008.5.1.4.1.1.88.33	Explicit VR Little Endian	1.2.840.10008.1.2.1

3.3.1.2.2 Real-World Activity “DICOM Browse”

DICOM Browse is activated when the user searches for an exam in Search screen.

3.3.1.2.2.1 Media Storage Application Profile for the Real-World Activity “DICOM Browse”

For the list of Application Profiles that invoke this AE for Image Read Real-World Activity, see the Table in Section 3.2.1 “Vivid v203 AE Specification”.

3.3.1.2.2.1.1 Options

Following are the SOP Classes supported by the Real-World Activity DICOM Browse:

Information Object Definition	SOP Class UID	Transfer Syntax	Transfer Syntax UID
DICOM Media Storage Directory	1.2.840.10008.1.3.10	Explicit VR Little Endian	1.2.840.10008.1.2.1
Ultrasound Multi-frame Image Storage	1.2.840.10008.5.1.4.1.1.3.1	Explicit VR Little Endian	1.2.840.10008.1.2.1
		Implicit VR Little Endian	1.2.840.10008.1.2
		Run Length Encoding, RLE	1.2.840.10008.1.2.5
		JPEG Baseline	1.2.840.10008.1.2.4.50

Ultrasound Multi-frame Image Storage(retired)	1.2.840.10008.5.1.4.1.1.3	Explicit VR Little Endian	1.2.840.10008.1.2.1
		Implicit VR Little Endian	1.2.840.10008.1.2
		Run Length Encoding, RLE	1.2.840.10008.1.2.5
		JPEG Baseline	1.2.840.10008.1.2.4.50
Ultrasound Image Storage	1.2.840.10008.5.1.4.1.1.6.1	Explicit VR Little Endian	1.2.840.10008.1.2.1
		Implicit VR Little Endian	1.2.840.10008.1.2
		Run Length Encoding, RLE	1.2.840.10008.1.2.5
		JPEG Baseline	1.2.840.10008.1.2.4.50
Ultrasound Image Storage (retired)	1.2.840.10008.5.1.4.1.1.6	Explicit VR Little Endian	1.2.840.10008.1.2.1
		Implicit VR Little Endian	1.2.840.10008.1.2
		Run Length Encoding, RLE	1.2.840.10008.1.2.5
		JPEG Baseline	1.2.840.10008.1.2.4.50
Secondary Capture Image Storage	1.2.840.10008.5.1.4.1.1.7	Explicit VR Little Endian	1.2.840.10008.1.2.1
		Implicit VR Little Endian	1.2.840.10008.1.2
		Run Length Encoding, RLE	1.2.840.10008.1.2.5
		JPEG Baseline	1.2.840.10008.1.2.4.50

Note: As shown in the table Implicit VR Little Endian Transfer Syntax is supported in addition to Transfer Syntaxes defined in Application Profiles.

3.3.1.2.3 Real-World Activity “Exam read“

“Exam read” reads and displays a DICOM SOP instance from media.

3.3.1.2.3.1 Media Storage Application Profile for the Real-World Activity “Exam read “

For the list of Application Profiles that invoke this AE for Exam read Real-World Activity, see the Table in Section 3.2.1 “Vivid v203 AE Specification”.

3.3.1.2.3.1.1 Options

Following are the SOP Classes supported by the Exam read Real-World Activity:

Information Object Definition	SOP Class UID	Transfer Syntax	Transfer Syntax UID
DICOM Media Storage Directory	1.2.840.10008.1.3.10	Explicit VR Little Endian	1.2.840.10008.1.2.1
Ultrasound Multi-frame Image Storage	1.2.840.10008.5.1.4.1.1.3.1	Explicit VR Little Endian	1.2.840.10008.1.2.1
		Implicit VR Little Endian	1.2.840.10008.1.2
		Run Length Encoding, RLE	1.2.840.10008.1.2.5
		JPEG Baseline	1.2.840.10008.1.2.4.5 0
Ultrasound Multi-frame Image Storage(retired)	1.2.840.10008.5.1.4.1.1.3	Explicit VR Little Endian	1.2.840.10008.1.2.1
		Implicit VR Little Endian	1.2.840.10008.1.2
		Run Length Encoding, RLE	1.2.840.10008.1.2.5
		JPEG Baseline	1.2.840.10008.1.2.4.5 0
Ultrasound Image Storage	1.2.840.10008.5.1.4.1.1.6.1	Explicit VR Little Endian	1.2.840.10008.1.2.1
		Implicit VR Little Endian	1.2.840.10008.1.2
		Run Length Encoding, RLE	1.2.840.10008.1.2.5
		JPEG Baseline	1.2.840.10008.1.2.4.5 0
Ultrasound Image Storage (retired)	1.2.840.10008.5.1.4.1.1.6	Explicit VR Little Endian	1.2.840.10008.1.2.1
		Implicit VR Little Endian	1.2.840.10008.1.2
		Run Length Encoding, RLE	1.2.840.10008.1.2.5
		JPEG Baseline	1.2.840.10008.1.2.4.5 0
Secondary Capture Image Storage	1.2.840.10008.5.1.4.1.1.7	Explicit VR Little Endian	1.2.840.10008.1.2.1
		Implicit VR Little Endian	1.2.840.10008.1.2
		Run Length Encoding, RLE	1.2.840.10008.1.2.5
		JPEG Baseline	1.2.840.10008.1.2.4.5 0

Note: As shown in the table Implicit VR Little Endian Transfer Syntax is supported in addition to Transfer Syntaxes defined in Application Profiles.

3.4 AUGMENTED AND PRIVATE APPLICATION PROFILES

Vivid v203 creates Secondary Capture Image and SR Objects in addition to the objects defined in the application profiles.

3.5 EXTENSIONS, SPECIALIZATIONS, PRIVATIZATIONS OF SOP CLASSES AND TRANSFER SYNTAXES

If so configured, the product will send ultrasound raw data information in private data elements designated by the Private Creator element:

Element Name	Tag	VR	VM	Description
Private Creator	7FE1,00xx	LO	1	GEMS_Ultrasound_MovieGroup_001

This means that all private tags starting with 7FE1,xx will belong to the GEMS_Ultrasound_MovieGroup_001.

If so configured, the product will send preview image in private data elements designated by the Private Creator element:

Element Name	Tag	VR	VM	Description
Private Creator	6003,00xx	LO	1	GEMS_Ultrasound_ImageGroup_001

This means that all private tags starting with 6003,xx will belong to the GEMS_Ultrasound_ImageGroup_001.

If so configured, the product will send exam information in private data elements designated by the Private Creator element:

Element Name	Tag	VR	VM	Description
Private Creator	6005,00xx	LO	1	GEMS_Ultrasound_ExamGroup_001

This means that all private tags starting with 6005,xx will belong to the GEMS_Ultrasound_ExamGroup_001.

DICOMDIR has also been extended with Standard Extended elements.

3.6 CONFIGURATION

The following parameters are configurable:

- Location of DICOMDIR
- Read or Read/Write
- Enable/disable raw data

- Frame rate reduction
- Enable/disable multi-frame
- Compression selections
- Enable/disable results (SR).
- Enable/disable private data elements in results (SR).
- Enable/disable “Signed Doppler Velocities” in results (SR).
- Enable/disable “Use older SR version”.
- Selection of SR version (when “Use older SR version” is enabled).

3.7 SUPPORT OF EXTENDED CHARACTER SETS

Vivid v203 will support only the ISO_IR 100 (ISO 8859-1:1987 Latin alphabet N 1. supplementary set) as extended character sets. Any incoming SOP instance that is encoded using another extended character set will not be read.

4. ULTRASOUND (US) INFORMATION OBJECT IMPLEMENTATION

4.1 INTRODUCTION

This section specifies the use of the DICOM US Image IOD to represent the information included in US images produced by this implementation. Corresponding attributes are conveyed using the module construct. The contents of this section are:

4.2 - IOD Implementation

4.3 - IOD Entity-Relationship Model

4.4 - IOD Module Table

4.5 - IOD Module Definition

In this section, supported means that tag is sent with value.

4.2 US IOD IMPLEMENTATION

This section defines the implementation of US image information object.

4.3 US ENTITY-RELATIONSHIP MODEL

The Entity-Relationship diagram for the US Image interoperability schema is shown in Illustration 4.3-1. In this figure, the following diagrammatic convention is established to represent the information organization:

- each entity is represented by a rectangular box
- each relationship is represented by a diamond shaped box.
- the fact that a relationship exists between two entities is depicted by lines connecting the corresponding entity boxes to the relationship boxes.

The relationships are fully defined with the maximum number of possible entities in the relationship shown. In other words, the relationship between Series and Image can have up to n Images per Series, but the Patient to Study relationship has 1 Patient for each Study (a Patient can have more than one Study on the system, however each Study will contain all of the information pertaining to that Patient).

ILLUSTRATION 4.3-1
US IMAGE ENTITY RELATIONSHIP DIAGRAM

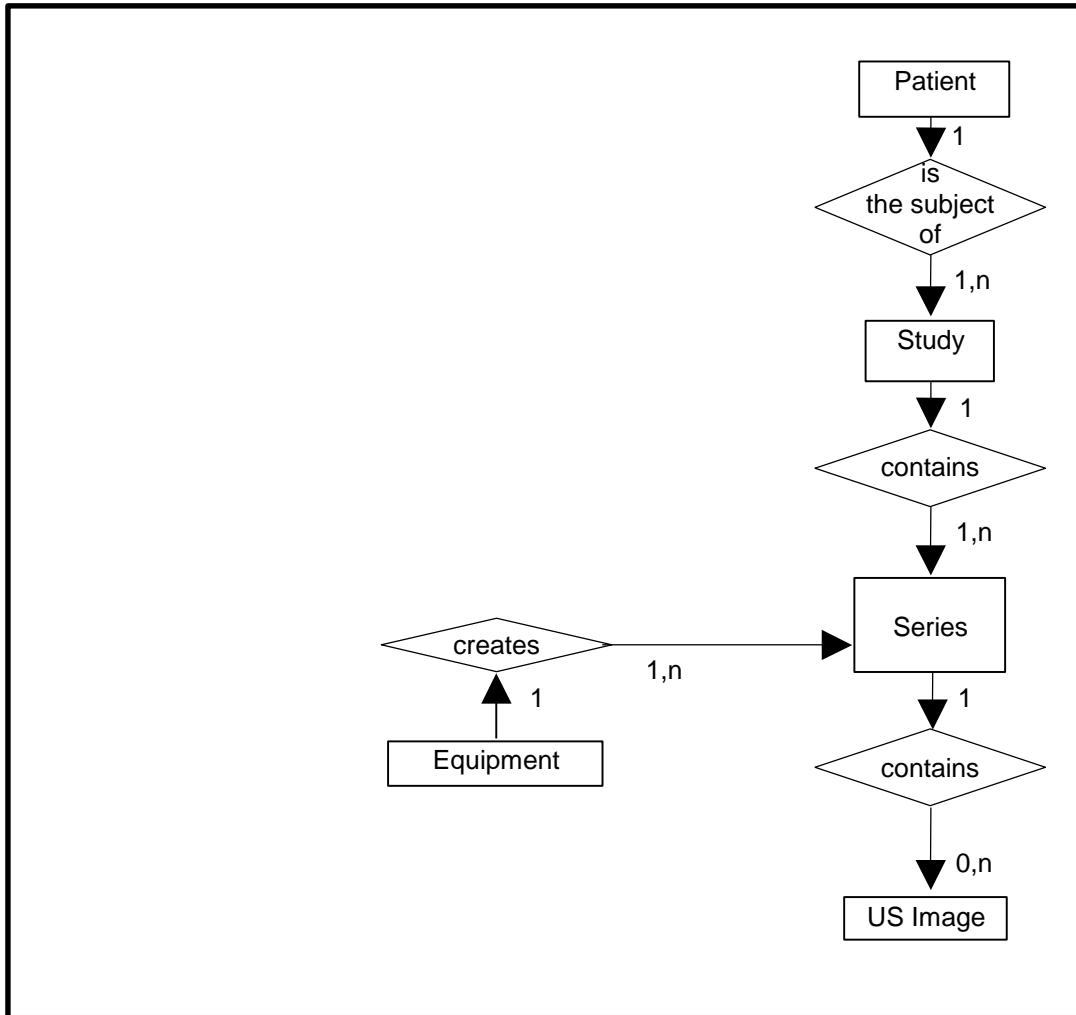

4.3.1 Entity Descriptions

Please refer to DICOM Standard Part 3 (Information Object Definitions) for a description of each of the entities contained within the US Information Object.

4.3.2 Vivid v203 Mapping of DICOM Entities

TABLE 4.3-1
MAPPING OF DICOM ENTITIES TO VIVID v203 ENTITIES

DICOM	Vivid v203 Entity
Patient	Patient
Study	Exam
Series	Exam
Image	Image
Curve	Not used

4.4 IOD MODULE TABLE

Within an entity of the DICOM US IOD, attributes are grouped into related set of attributes. A set of related attributes is termed a module. A module facilitates the understanding of the semantics concerning the attributes and how the attributes are related with each other. A module grouping does not infer any encoding of information into data sets.

Table 4.4-1 identifies the defined modules within the entities, which comprise the DICOM US IOD. Modules are identified by Module Name.

See DICOM Part 3 for a complete definition of the entities, modules, and attributes.

Only the single frame US Image IOD is described here.

**TABLE 4.4-1
US IMAGE IOD MODULES**

Entity Name	Module Name	Reference
Patient	Patient	4.5.1.1
Study	General Study	4.5.2.1
	Patient Study	4.5.2.2
Series	General Series	4.5.3.1
Frame of Reference	Frame of Reference	Not used
	US Frame of Reference	Not used
Equipment	General Equipment	4.5.4.1
Image	General Image	4.5.5.1
	Image Pixel	4.5.5.2
	Contrast/Bolus	4.5.5.3
	Palette Color Lookup Table	4.5.5.4
	US Region Calibration	4.5.7.1
	US Image	4.5.7.2
	Overlay Plane	Not used
	VOI LUT	4.5.5.5
SOP Common	4.5.6.1	
Curve	Not used	

4.5 INFORMATION MODULE DEFINITIONS

Please refer to DICOM Standard Part 3 (Information Object Definitions) for a description of each of the entities and modules contained within the US Information Object.

The following modules are included to convey Enumerated Values, Defined Terms, and Optional Attributes supported. Type 1 & Type 2 Attributes are also included for completeness and to define what values they may take and where these values are obtained. It should be noted that they are the same ones as defined in the DICOM Standard Part 3 (Information Object Definitions).

4.5.1 Common Patient Entity Modules

4.5.1.1 Patient Module

This section specifies the Attributes of the Patient that describe and identify the Patient who is the subject of a diagnostic Study. This Module contains Attributes of the patient that are needed for diagnostic interpretation of the Image and are common for all studies performed on the patient.

**TABLE 4.5-1
PATIENT MODULE ATTRIBUTES**

Attribute Name	Tag	Type	Attribute Description
Patient's Name	(0010,0010)	2	May be entered from User Interface. Taken from worklist if it is there.
Patient ID	(0010,0020)	2	May be entered from User Interface. Taken from worklist if it is there.
Issuer of Patient ID	(0010,0021)	3	Taken from worklist if it is there.
Issuer of Patient ID Qualifiers Sequence	(0010,0024)	3	
>Universal Entity ID	(0040,0032)	3	Taken from worklist if it is there.
>Universal Entity ID Type	(0040,0033)	1C	Taken from worklist if it is there.
>Identifier Type Code	(0040,0035)	3	Taken from worklist if it is there.
Patient's Birth Date	(0010,0030)	2	May be entered from User Interface. Taken from worklist if it is there.
Patient's Sex	(0010,0040)	2	May be entered from User Interface. Taken from worklist if it is there.
Referenced Patient Sequence	(0008,1120)	3	
>Referenced SOP Class UID	(0008,1150)	1	Taken from worklist if it is there. (Not used in SR Documents.)
>Referenced SOP Instance UID	(0008,1155)	1	Taken from worklist if it is there. (Not used in SR Documents.)
Patient's Birth Time	(0010,0032)	3	Taken from worklist if it is there.
Other Patient Ids	(0010,1000)	3	May be entered from User Interface. Taken from worklist if it is there.
Other Patient Names	(0010,1001)	3	Not used
Other Patient IDs Sequence	(0010,1002)	3	
>Patient ID	(0010,0020)	1	May be entered from User Interface. Taken from worklist if it is there.
>Issuer of Patient ID	(0010,0021)	3	Taken from worklist if it is there.
>Type of Patient ID	(0010,0022)	1	The value is set to 'TEXT'.
>Issuer of Patient ID Qualifiers Sequence	(0010,0024)	3	
>>Universal Entity ID	(0040,0032)	3	Taken from worklist if it is there.
>>Universal Entity ID Type	(0040,0033)	1C	Taken from worklist if it is there.
>>Identifier Type Code	(0040,0035)	3	Taken from worklist if it is there.
Ethnic Group	(0010,2160)	3	Taken from worklist if it is there.
Patient Comments	(0010,4000)	3	Taken from worklist if it is there.
Patient Identity Removed	(0012,0062)	3	Present and set to "YES" if patient is anonymized.

Attribute Name	Tag	Type	Attribute Description
De-identification Method	(0012,0063)	1C	Present and set to "GEVU anonymization" if patient is anonymized.

4.5.2 Common Study Entity Modules

The following Study IE Modules are common to all Composite Image IODs, which reference the Study IE. These modules contain Attributes of the patient and study that are needed for diagnostic interpretation of the image.

4.5.2.1 General Study Module

This section specifies the attributes that describe and identify the Study performed upon the Patient.

**TABLE 4.5-2
GENERAL STUDY MODULE ATTRIBUTES**

Attribute Name	Tag	Type	Attribute Description
Study Instance UID	(0020,000D)	1	Uniquely generated by the equipment. Taken from worklist if it is there.
Study Date	(0008,0020)	2	Is set to examination date
Study Time	(0008,0030)	2	Is set to examination time
Referring Physician's Name	(0008,0090)	2	May be entered from User Interface. Taken from worklist if it is there.
Study ID	(0020,0010)	2	May be entered from User Interface. Taken from worklist if it is there (from Requested Procedure Id)
Accession Number	(0008,0050)	2	May be entered from User Interface. Taken from worklist if it is there.
Study Description	(0008,1030)	3	May be entered from User Interface. Taken from worklist if it is there (from Requested Procedure Description).
Physician(s) of Record	(0008,1048)	3	Taken from worklist if it is there (from Names of Intended Recipients of Result)
Name of Physician(s) Reading Study	(0008,1060)	3	Not used
Referenced Study Sequence	(0008,1110)	3	
>Referenced SOP Class UID	(0008,1150)	1	Taken from worklist if it is there. (Not used in SR Documents.)
>Referenced SOP Instance UID	(0008,1155)	1	Taken from worklist if it is there. (Not used in SR Documents.)

4.5.2.2 Patient Study Module

This section defines attributes that provide information about the Patient at the time that the Study was performed.

**TABLE 4.5-3
PATIENT STUDY MODULE ATTRIBUTES**

Attribute Name	Tag	Type	Attribute Description
Admitting Diagnoses Description	(0008,1080)	3	Not used
Patient's Age	(0010,1010)	3	Not used
Patient's Size	(0010,1020)	3	May be entered from User Interface. Taken from worklist if it is there.
Patient's Weight	(0010,1030)	3	May be entered from User Interface. Taken from worklist if it is there.
Occupation	(0010,2180)	3	Not used
Additional Patient's History	(0010,21B0)	3	May be entered from User Interface (in Referral reason). Taken from worklist if it is there.
Admission ID	(0038,0010)	3	Taken from worklist if it is there.

4.5.3 Common Series Entity Modules

The following Series IE Modules are common to all Composite Image IODs, which reference the Series IE.

4.5.3.1 General Series Module

This section specifies the attributes that identify and describe general information about the Series within a Study.

**TABLE 4.5-4
GENERAL SERIES MODULE ATTRIBUTES**

Attribute Name	Tag	Type	Attribute Description
Modality	(0008,0060)	1	Defined Terms "US" or "SR" are used.
Series Instance UID	(0020,000E)	1	Uniquely generated by the equipment
Series Number	(0020,0011)	2	Internal number which is incremented for each new series within a study.
Laterality	(0020,0060)	2C	Not used
Series Date	(0008,0021)	3	Is set to Series date
Series Time	(0008,0031)	3	Is set to Series time
Performing Physicians' Name	(0008,1050)	3	May be entered from User Interface. Taken from worklist if it is there (from Scheduled Performing Physician's Name)
Protocol Name	(0018,1030)	3	Sent if image is acquired in a stress test.
Series Description	(0008,103E)	3	May be entered from User Interface (in Diagnosis).
Operator's Name	(0008,1070)	3	May be entered from User Interface. Default is login id.
Referenced Performed Procedure Step Sequence	(0008,1111)	3	
>Referenced SOP Class UID	(0008,1150)	1	Used if Modality Performed Procedure Step is enabled.
>Referenced SOP Instance UID	(0008,1155)	1	Used if Modality Performed Procedure Step is enabled.
Body Part Examined	(0018,0015)	3	Not used
Patient Position	(0018,5100)	2C	Not used
Smallest Pixel Value in Series	(0028,0108)	3	Not used
Largest Pixel Value in Series	(0028,0109)	3	Not used
Request Attributes Sequence	(0040,0275)	3	
>Requested Procedure ID	(0040,1001)	1C	Taken from worklist if it is there.
>Scheduled Procedure Step ID	(0040,0009)	1C	Taken from worklist if it is there.
>Scheduled Procedure Step Description	(0040,0007)	3	Taken from worklist if it is there.
>Scheduled Protocol Code Sequence	(0040,0008)	3	
>>Include 'Code Sequence Macro'			
Performed Procedure Step ID	(0040,0253)	3	Used if Modality Performed Procedure Step is enabled.
Performed Procedure Step Start Date	(0040,0244)	3	Used if Modality Performed Procedure Step is enabled.
Performed Procedure Step Start Time	(0040,0245)	3	Used if Modality Performed Procedure Step is enabled.

Performed Procedure Step Description	(0040,0254)	3	Used if Modality Performed Procedure Step is enabled.
Performed Protocol Code Sequence	(0040,0260)	3	
>Include 'Code Sequence Macro'			Taken from worklist or selected protocol.

4.5.4 Common Equipment Entity Modules

The following Equipment IE Module is common to all Composite Image IODs, which reference the Equipment IE.

4.5.4.1 General Equipment Module

This section specifies the attributes that identify and describe the piece of equipment, which produced a Series of Images.

**TABLE 4.5-5
GENERAL EQUIPMENT MODULE ATTRIBUTES**

Attribute Name	Tag	Type	Attribute Description
Manufacturer	(0008,0070)	2	Is set to "GE Vingmed Ultrasound"
Institution Name	(0008,0080)	3	Is set to configured Institution Name.
Institution Address	(0008,0081)	3	Not used
Station Name	(0008,1010)	3	Is set to configured Station Name.
Institutional Department Name	(0008,1040)	3	May be entered from User Interface. Default is configured Department name.
Manufacturer's Model Name	(0008,1090)	3	Is set to the model name of the Vivid scanner. For example, "Vivid E95" for the Vivid E95 model.
Device Serial Number	(0018,1000)	3	Not used
Software Versions	(0018,1020)	3	Is set to the Vivid v203 software version
Spatial Resolution	(0018,1050)	3	Not used
Date of Last Calibration	(0018,1200)	3	Not used
Time of Last Calibration	(0018,1201)	3	Not used
Pixel Padding Value	(0028,0120)	1C	Not used

4.5.5 Common Image Entity Modules

The following Image IE Modules are common to all Composite Image IODs, which reference the Image IE.

4.5.5.1 General Image Module

This section specifies the attributes that identify and describe an image within a particular series.

**TABLE 4.5-6
GENERAL IMAGE MODULE ATTRIBUTES**

Attribute Name	Tag	Type	Attribute Description
Instance Number	(0020,0013)	2	Internal value which is incremented for each image within a series
Patient Orientation	(0020,0020)	2C	Sent with empty value.
Content Date	(0008,0023)	2C	Set from Image date

Attribute Name	Tag	Type	Attribute Description
Content Time	(0008,0033)	2C	Set from Image time
Image Type	(0008,0008)	3	The first two values contain "ORIGINAL\PRIMARY" or "DERIVED\PRIMARY". Value 3 is always empty. Value 4 is a description of the mode. Values beyond this may be used for private data.
Acquisition Number	(0020,0012)	3	Not used
Acquisition Date	(0008,0022)	3	Not used
Acquisition Time	(0008,0032)	3	Not used
Acquisition Datetime	(0008,002A)	3	Supported
Referenced Image Sequence	(0008,1140)	3	
>Referenced SOP Class UID	(0008,1150)	1	May be used for related images
>Referenced SOP Instance UID	(0008,1155)	1	May be used for related images
>Referenced Frame Number	(0008,1160)	3	Not used
Derivation Description	(0008,2111)	3	May contain additional derivation information if Image Type is DERIVED.
Source Image Sequence	(0008,2112)	3	
>Referenced SOP Class UID	(0008,1150)	1	May be used for source images
>Referenced SOP Instance UID	(0008,1155)	1	May be used for source images
>Referenced Frame Number	(0008,1160)	3	Not used
Images in Acquisition	(0020,1002)	3	Not used
Image Comments	(0020,4000)	3	May be used for description of the image
Quality Control Image	(0028,0300)	3	Not used
Burned In Annotation	(0028,0301)	3	Used if identifying info is included in the image
Lossy Image Compression	(0028,2110)	3	Set to 01 if image is lossy compressed.
Lossy Image Compression Ratio	(0028,2112)	3	Used if lossy compressed.

4.5.5.2 Image Pixel Module

This section specified the attributes that describe the pixel data of the image.

**TABLE 4.5-7
IMAGE PIXEL MODULE ATTRIBUTES**

Attribute Name	Tag	Type	Attribute Description
Samples per Pixel	(0028,0002)	1	Value of '1' if Photometric Interpretation element value has value "MONOCHROME2" or "PALETTE COLOR" (only for read) Value of '3' when Photometric Interpretation element value has value "RGB", "YBR_FULL" or "YBR_FULL_422"

Attribute Name	Tag	Type	Attribute Description
Photometric Interpretation	(0028,0004)	1	Defined Values used: "MONOCHROME2", "RGB", "YBR_FULL", "YBR_FULL_422" or "PALETTE COLOR" (only for read)
Rows	(0028,0010)	1	Value depends on scanning mode and configuration setup
Columns	(0028,0011)	1	Value depends on scanning mode and configuration setup.
Bits Allocated	(0028,0100)	1	Value always = 0008H.
Bits Stored	(0028,0101)	1	Value always = 0008H.
High Bit	(0028,0102)	1	Value always = 0007H.
Pixel Representation	(0028,0103)	1	Defined Value '0' - unsigned integer.
Pixel Data	(7FE0,0010)	1	Pixel Data of image.
Planar Configuration	(0028,0006)	1C	Enumerated value 0000H, color-by-pixel, if Photometric Interpretation element value has value 'RGB' (uncompressed) or if image is JPEG compressed. Enumerated value 0001H, color-by-plane if image is RLE compressed.
Pixel Aspect Ratio	(0028,0034)	1C	Not used
Smallest Image Pixel Value	(0028,0106)	3	Not used
Largest Image Pixel Value	(0028,0107)	3	Not used
Red Palette Color Lookup Table Descriptor	(0028,1101)	1C	Only used when reading Palette images.
Green Palette Color Lookup Table Descriptor	(0028,1102)	1C	Only used when reading Palette images.
Blue Palette Color Lookup Table Descriptor	(0028,1103)	1C	Only used when reading Palette images.
Red Palette Color Lookup Table Data	(0028,1201)	1C	Only used when reading Palette images.
Green Palette Color Lookup Table Data	(0028,1202)	1C	Only used when reading Palette images.
Blue Palette Color Lookup Table Data	(0028,1203)	1C	Only used when reading Palette images.

4.5.5.3 Contrast/Bolus Module

This section specifies the attributes that describe the contrast /bolus used in the acquisition of the Image.

**TABLE 4.5-8
CONTRAST/BOLUS MODULE ATTRIBUTES**

Attribute Name	Tag	Type	Attribute Description
Contrast/Bolus Agent	(0018,0010)	2	May be entered from User Interface.
Contrast/Bolus Agent Sequence	(0018,0012)	3	Not used
>Include 'Code Sequence Macro'			
Contrast/Bolus Route	(0018,1040)	3	Not used
Contrast/Bolus Administration Route Sequence	(0018,0014)	3	Not used
>Include 'Code Sequence Macro'			

Attribute Name	Tag	Type	Attribute Description
>Additional Drug Sequence	(0018,002A)	3	Not used
>>Include 'Code Sequence Macro'			
Contrast/Bolus Volume	(0018,1041)	3	Not used
Contrast/Bolus Start Time	(0018,1042)	3	Not used
Contrast/Bolus Stop Time	(0018,1043)	3	Not used
Contrast/Bolus Total Dose	(0018,1044)	3	Not used
Contrast Flow Rate(s)	(0018,1046)	3	Not used
Contrast Flow Duration(s)	(0018,1047)	3	Not used
Contrast/Bolus Ingredient	(0018,1048)	3	Not used
Contrast/Bolus Ingredient Concentration	(0018,1049)	3	Not used

4.5.5.4 Palette Color Lookup Table Module

This section specifies the attributes that describe the Lookup table data for images with Palette Color photometric interpretation.

**TABLE 4.5-9
PALETTE COLOR LOOKUP MODULE**

Attribute Name	Tag	Type	Attribute Description
Red Palette Color Lookup Table Descriptor	(0028,1101)	1	Only used when reading Palette images.
Green Palette Color Lookup Table Descriptor	(0028,1102)	1	Only used when reading Palette images.
Blue Palette Color Lookup Table Descriptor	(0028,1103)	1	Only used when reading Palette images.
Palette Color Lookup Table UID	(0028,1199)	3	Not used
Red Palette Color Lookup Table Data	(0028,1201)	1C	Only used when reading Palette images.
Green Palette Color Lookup Table Data	(0028,1202)	1C	Only used when reading Palette images.
Blue Palette Color Lookup Table Data	(0028,1203)	1C	Only used when reading Palette images.
Segmented Red Palette Color Lookup Table Data	(0028,1221)	1C	Not used
Segmented Green Palette Color Lookup Table Data	(0028,1222)	1C	Not used
Segmented Red Palette Color Lookup Table Data	(0028,1223)	1C	Not used

4.5.5.5 VOI LUT Module

This section specifies the attributes that identify and describe the VOI LUT Module

**TABLE 4.5-10
VOI LUT MODULE ATTRIBUTES**

Attribute Name	Tag	Type	Attribute Description
VOI LUT Sequence	(0028,3010)	1C	Not used
>LUT Descriptor	(0028,3002)	1	Not used
>LUT Explanation	(0028,3003)	3	Not used
>LUT Data	(0028,3006)	1	Not used
Window Center	(0028,1050)	1C	Value set to 127 if Photometric Interpretation has value MONOCHROME2.
Window Width	(0028,1051)	1C	Value set to 256 if Photometric Interpretation has value MONOCHROME2.
Window Center & Width Explanation	(0028,1055)	3	Not used

4.5.6 General Modules

The SOP Common Module is mandatory for all DICOM IODs.

4.5.6.1 SOP Common Module

This section defines the attributes that are required for proper functioning and identification of the associated SOP Instances. They do not specify any semantics about the Real-World Object represented by the IOD.

**TABLE 4.5-11
SOP COMMON MODULE ATTRIBUTES**

Attribute Name	Tag	Type	Attribute Description
SOP Class UID	(0008,0016)	1	Set to “1.2.840.10008.5.1.4.1.1.3.1” “1.2.840.10008.5.1.4.1.1.3” “1.2.840.10008.5.1.4.1.1.6.1” “1.2.840.10008.5.1.4.1.1.6” “1.2.840.10008.5.1.4.1.1.7” or “1.2.840.10008.5.1.4.1.1.88.33”
SOP Instance UID	(0008,0018)	1	Uniquely generated by the equipment
Specific Character Set	(0008,0005)	1C	Set to “ISO_IR 100” if extended characters are used. Image Read: images using other extended character set than “ISO_IR 100” are rejected.
Instance Creation Date	(0008,0012)	3	Not used
Instance Creation Time	(0008,0013)	3	Not used
Instance Creator UID	(0008,0014)	3	Not used
Instance Number	(0020,0013)	3	Not used

4.5.7 US Modules

This Section describes US Series, Equipment, and Image Modules. These Modules contain attributes that are specific to US Image IOD.

4.5.7.1 US Region Calibration Module

US Region Calibration Module is used to describe multiple regions. Note: if a multi-frame image has been acquired with different calibration, the US Region Calibration Module will not be used.

TABLE 4.5-12
US REGION CALIBRATION MODULE ATTRIBUTES

Attribute Name	Tag	Type	Attribute Description
Sequence of Ultrasound Regions	(0018,6011)	1	Supported.
>Region Location Min x_0	(0018,6018)	1	Varies with scanning mode
>Region Location Min y_0	(0018,601A)	1	Varies with scanning mode
>Region Location Max x_1	(0018,601C)	1	Value is image width-1.
>Region Location Max y_1	(0018,601E)	1	Value is image height-1
>Physical Units X Direction	(0018,6024)	1	Enumerated Values supported: 0003H cm 0004H seconds
>Physical Units Y Direction	(0018,6026)	1	Enumerated Values supported: 0003H cm 0004H seconds 0007H cm/sec
>Physical Delta X	(0018,602C)	1	Varies with scanning mode
>Physical Delta Y	(0018,602E)	1	Varies with scanning mode
>Reference Pixel x_0	(0018,6020)	3	Varies with scanning mode
>Reference Pixel y_0	(0018,6022)	3	Varies with scanning mode
>Ref. Pixel Physical Value X	(0018,6028)	3	Varies with scanning mode
>Ref. Pixel Physical Value Y	(0018,602A)	3	Varies with scanning mode
>Region Spatial Format	(0018,6012)	1	Supported. The spatial organization of the data within the region.
>Region Data Type	(0018,6014)	1	Supported. The type of data within the region.
>Region Flags	(0018,6016)	1	Bit 0: 0 = Opaque Bit 1: 0 = Not Protected because there may be other regions within the image Bit 2: 0 = Velocity
>Pixel Component Organization	(0018,6044)	1C	Pixel component calibration data does not exist for any region
>Pixel Component Mask	(0018,6046)	1C	Not used
>Pixel Component Range Start	(0018,6048)	1C	Not used
>Pixel Component Range Stop	(0018,604A)	1C	Not used
>Pixel Component Physical Units	(0018,604C)	1C	Not used
>Pixel Component Data Type	(0018,604E)	1C	Not used
>Number of Table Break Points	(0018,6050)	1C	Not used
>Table of X Break Points	(0018,6052)	1C	Not used
>Table of Y Break Points	(0018,6054)	1C	Not used
>Number of Table Entries	(0018,6056)	1C	Not used
>Table of Pixel Values	(0018,6058)	1C	Not used

Attribute Name	Tag	Type	Attribute Description
>Table of Parameter Values	(0018,605A)	1C	Not used
>Transducer Frequency	(0018,6030)	3	Supported
>Pulse Repetition Frequency	(0018,6032)	3	Supported
>Doppler Correction Angle	(0018,6034)	3	Not used
>Steering Angle	(0018,6036)	3	Not used
>Doppler Sample Volume X Position	(0018,6038)	3	Not used
>Doppler Sample Volume Y Position	(0018,603A)	3	Not used
>TM-Line Position x_0	(0018,603C)	3	Not used
>TM-Line Position y_0	(0018,603E)	3	Not used
>TM-Line Position x_1	(0018,6040)	3	Not used
>TM-Line Position y_1	(0018,6042)	3	Not used

4.5.7.2 US Image Module

This section specifies the attributes that describe ultrasound images.

**TABLE 4.5-13
US IMAGE MODULE ATTRIBUTES**

Attribute Name	Tag	Type	Attribute Description
Samples Per Pixel	(0028,0002)	1	Value of '1' if Photometric Interpretation element value has value "MONOCHROME2" or "PALETTE COLOR" (only for read) Value of '3' when Photometric Interpretation element value has value "RGB", "YBR_FULL" or "YBR_FULL_422"
Photometric Interpretation	(0028,0004)	1	Defined Values used: "MONOCHROME2", "RGB", "YBR_FULL", "YBR_FULL_422" or "PALETTE COLOR" (only for read).
Bits Allocated	(0028,0100)	1	Value always = 0008H
Bits Stored	(0028,0101)	1	Value always = 0008H
High Bit	(0028,0102)	1	Value always = 0007H
Planar Configuration	(0028,0006)	1C	Enumerated value 0000H, color-by-pixel, if Photometric Interpretation element value has value 'RGB' (uncompressed) or if image is JPEG compressed. Enumerated value 0001H, color-by-plane if image is RLE compressed.
Pixel Representation	(0028,0103)	1	Always 0000H = unsigned integer.
Frame Increment Pointer	(0028,0009)	1C	Export: Is set to Frame Time (0018,1063) or Frame Time Vector (0018,1065) if the image is multiframe IOD, Not used if the image is a single frame IOD.
Image Type	(0008,0008)	2	The first two values contain "ORIGINAL\PRIMARY" or "DERIVED\PRIMARY". Value 4 is a description of the mode. Values 5 and 6 may be used for private data.
Lossy Image Compression	(0028,2110)	1C	Set to 01 if image is compressed using JPEG Baseline compression.
Number of Stages	(0008,2124)	2C	Number of stages in stress protocol. Sent if image is acquired in a stress test.
Number of Views in Stage	(0008,212A)	2C	Number of views in this stage of a stress protocol. Sent if image is acquired in a stress test.
R Wave Time Vector	(0018,6060)	3	May be filled in with timing information

Attribute Name	Tag	Type	Attribute Description
Ultrasound Color Data Present	(0028,0014)	3	Supported
Referenced Overlay Sequence	(0008,1130)	3	Not used
>Referenced SOP Class UID	(0008,1150)	1	Not used
>Referenced SOP Instance UID	(0008,1155)	1	Not used
Referenced Curve Sequence	(0008,1145)	3	Not used
>Referenced SOP Class UID	(0008,1150)	1	Not used
>Referenced SOP Instance UID	(0008,1155)	1	Not used
Stage Name	(0008,2120)	3	Name of stage of stress test. Sent if image is acquired in a stress test. The name is defined in the User Interface.
Stage Code Sequence	(0040,000A)	3	Coded stage name of stress test. Sent if image is acquired in a stress test. The name is defined in the User Interface.
>Include 'Code Sequence Macro'			
Stage Number	(0008,2122)	3	Number of stage, starting at one. Sent if image is acquired in a stress test.
View Name	(0008,2127)	3	Name of view of stress test. Sent if image is acquired in a stress test. The name is defined in the User Interface.
View Code Sequence	(0054,0220)	3	Coded view name of stress test. Sent if image is acquired in a stress test. The name is defined in the User Interface
>Include 'Code Sequence Macro'			
View Number	(0008,2128)	3	Number of view, starting at one. Sent if image is acquired in a stress test.
Number of Event Timers	(0008,2129)	3	Only used when reading images
Event Elapsed Time(s)	(0008,2130)	3	Only used when reading images
Event Timer Name(s)	(0008,2132)	3	Only used when reading images
Anatomic Region Sequence	(0008,2218)	3	Not used
>Include 'Code Sequence Macro'			
>Anatomic Region Modifier Sequence	(0008,2220)	3	Not used
>>Include 'Code Sequence Macro'			
Primary Anatomic Structure Sequence	(0008,2228)	3	Not used
>Include 'Code Sequence Macro'			
>Primary Anatomic Structure Modifier Sequence	(0008,2230)	3	Not used
>>Include 'Code Sequence Macro'			

Attribute Name	Tag	Type	Attribute Description
Trigger Time	(0018,1060)	3	Not used
Nominal Interval	(0018,1062)	3	Not used
Beat Rejection Flag	(0018,1080)	3	Not used
Low R-R Value	(0018,1081)	3	Not used
High R-R Value	(0018,1082)	3	Not used
Heart Rate	(0018,1088)	3	Set to heart rate
Output Power	(0018,5000)	3	Not used
Transducer Data	(0018,5010)	3	Not used
Transducer Type	(0018,6031)	3	Not used
Focus Depth	(0018,5012)	3	Not used
Preprocessing Function	(0018,5020)	3	Not used
Mechanical Index	(0018,5022)	3	Not used
Bone Thermal Index,	(0018,5024)	3	Not used
Cranial Thermal Index	(0018,5026)	3	Not used
Soft Tissue Thermal Index	(0018,5027)	3	Not used
Soft Tissue-focus Thermal Index	(0018,5028)	3	Not used
Soft Tissue-surface Thermal Index	(0018,5029)	3	Not used
Depth of Scan Field	(0018,5050)	3	Not used
Image Transformation Matrix	(0018,5210)	3	Not used
Image Translation Vector	(0018,5212)	3	Not used
Overlay Subtype	(60xx,0045)	3	Not used

5. ULTRASOUND MULTIFRAME (US MF) INFORMATION OBJECT IMPLEMENTATION

5.1 INTRODUCTION

This section specifies the use of the DICOM US Multi-frame Image IOD to represent the information included in US images produced by this implementation. Corresponding attributes are conveyed using the module construct. The contents of this section are:

5.2 - IOD Implementation

5.3 - IOD Entity-Relationship Model

5.4 - IOD Module Table

5.5 - IOD Module Definition

5.2 US MF IOD IMPLEMENTATION

This section defines the implementation of US Multi-Frame image information object.

5.3 US MF ENTITY-RELATIONSHIP MODEL

The Entity-Relationship diagram for the US MF Image interoperability schema is shown in Illustration 5.3-1. In this figure, the following diagrammatic convention is established to represent the information organization:

- each entity is represented by a rectangular box
- each relationship is represented by a diamond shaped box.
- the fact that a relationship exists between two entities is depicted by lines connecting the corresponding entity boxes to the relationship boxes.

The relationships are fully defined with the maximum number of possible entities in the relationship shown. In other words, the relationship between Series and Image can have up to n Images per Series, but the Patient to Study relationship has 1 Study for each Patient (a Patient can have more than one Study on the system, however each Study will contain all of the information pertaining to that Patient).

ILLUSTRATION 5.3-1
US MULTIFRAME IMAGE ENTITY RELATIONSHIP DIAGRAM

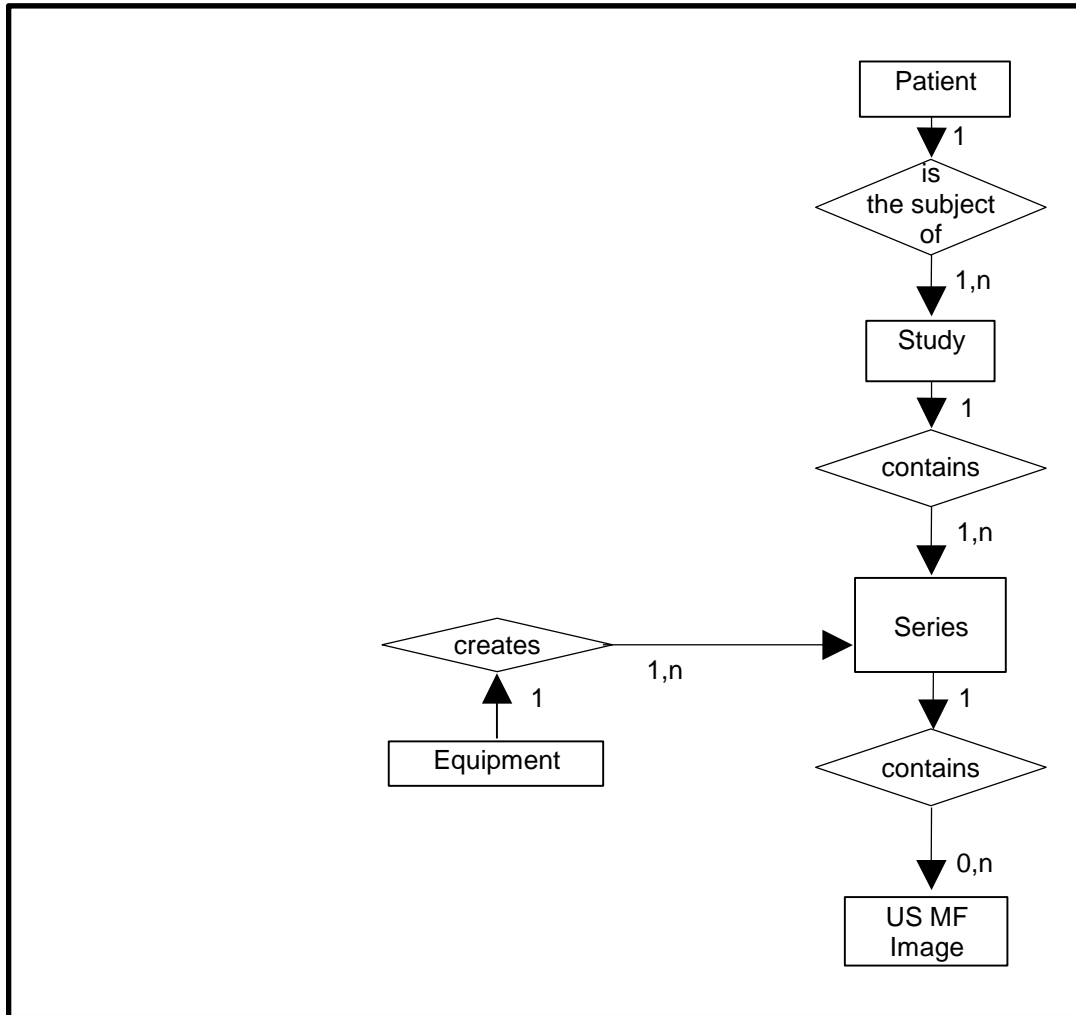

5.3.1 Entity Descriptions

Please refer to DICOM Standard Part 3 (Information Object Definitions) for a description of each of the entities contained within the US Multi-Frame Information Object.

5.3.2 Vivid v203 Mapping of DICOM entities

TABLE 5.3-1
MAPPING OF DICOM ENTITIES TO VIVID v203 ENTITIES

DICOM	Vivid v203 Entity
Patient	Patient
Study	Exam
Series	Exam
Image	Image
Curve	Not used

5.4 IOD MODULE TABLE

Within an entity of the DICOM US Multi-Frame IOD, attributes are grouped into related set of attributes. A set of related attributes is termed a module. A module facilitates the understanding of the semantics concerning the attributes and how the attributes are related with each other. A module grouping does not infer any encoding of information into datasets.

Table 5.4-1 identifies the defined modules within the entities, which comprise the DICOM US Multi-Frame IOD. Modules are identified by Module Name.

See DICOM Part 3 for a complete definition of the entities, modules, and attributes.

TABLE 5.4-1
US MULTI-FRAME IOD MODULES

Entity Name	Module Name	Reference
Patient	Patient	4.5.1.1
Study	General Study	4.5.2.1
	Patient Study	4.5.2.2
Series	General Series	4.5.3.1
Frame of Reference	Frame of Reference	Not used
	US Frame of Reference	Not used
Equipment	General Equipment	4.5.4.1
Image	General Image	4.5.5.1
	Image Pixel	4.5.5.2
	Contrast/Bolus	4.5.5.3
	Cine	5.5.1.1
	Multi-frame	5.5.1.2
	Palette Color Lookup Table	4.5.5.4
	US Region Calibration	4.5.7.1
	US Image	4.5.7.2
Curve	VOI LUT	4.5.5.5
	SOP Common	4.5.6.1
Curve	Not used	

5.5 INFORMATION MODULE DEFINITIONS

Please refer to DICOM Standard Part 3 (Information Object Definitions) for a description of each of the entities and modules contained within the US Multi-Frame Information Object.

The following modules are included to convey Enumerated Values, Defined Terms, and Optional Attributes supported. Type 1 & Type 2 Attributes are also included for completeness and to define what values they may take and where these values are

obtained. It should be noted that they are the same ones as defined in the DICOM Standard Part 3 (Information Object Definitions).

5.5.1 Common Image Modules

The following Image IE Modules are common to all Composite Image IODs which reference the Image IE.

5.5.1.1 Cine Module

**TABLE 5.5-2
CINE MODULE ATTRIBUTES**

Attribute Name	Tag	Type	Attribute Description
Frame Time	(0018,1063)	1C	Is set to the interframe time
Frame Time Vector	(0018,1065)	1C	Supported. Reading: Average value is set to interframe time
Start Trim	(0008,2142)	3	Supported
Stop Trim	(0008,2143)	3	Supported
Recommended Display Frame Rate	(0008,2144)	3	Supported
Cine Rate	(0018,0040)	3	Supported
Frame Delay	(0018,1066)	3	Supported
Effective Duration	(0018,0072)	3	Supported
Actual Frame Duration	(0018,1242)	3	Supported
Preferred Playback Sequencing	(0018,1244)	3	Supported

5.5.1.2 Multi-frame Module

**TABLE 5.5-3
MULTI-FRAME MODULE ATTRIBUTES**

Attribute Name	Tag	Type	Attribute Description
Number of Frames	(0028,0008)	1	Is set to the number of frames in image
Frame Increment Pointer	(0028,0009)	1	Is set to Frame Time (0018,1063) or Frame Time Vector (0018,1065)

6. SC INFORMATION OBJECT IMPLEMENTATION

6.1 INTRODUCTION

This section specifies the use of the DICOM SC Image IOD to represent the information included in SC images produced by this implementation. Corresponding attributes are conveyed using the module construct. The contents of this section are:

6.2 - IOD Implementation

6.3 - IOD Entity-Relationship Model

6.4 - IOD Module Table

6.5 - IOD Module Definition

6.2 SC IOD IMPLEMENTATION

This section defines the implementation of SC image information object.

6.3 SC ENTITY-RELATIONSHIP MODEL

The Entity-Relationship diagram for the SC Image interoperability schema is shown in Illustration 6.3-1. In this figure, the following diagrammatic convention is established to represent the information organization:

- each entity is represented by a rectangular box
- each relationship is represented by a diamond shaped box.
- the fact that a relationship exists between two entities is depicted by lines connecting the corresponding entity boxes to the relationship boxes.

The relationships are fully defined with the maximum number of possible entities in the relationship shown. In other words, the relationship between Series and Image can have up to n Images per Series, but the Patient to Study relationship has 1 Patient for each Study (a Patient can have more than one Study on the system, however each Study will contain all of the information pertaining to that Patient).

ILLUSTRATION 6.3-1
SC IMAGE ENTITY RELATIONSHIP DIAGRAM

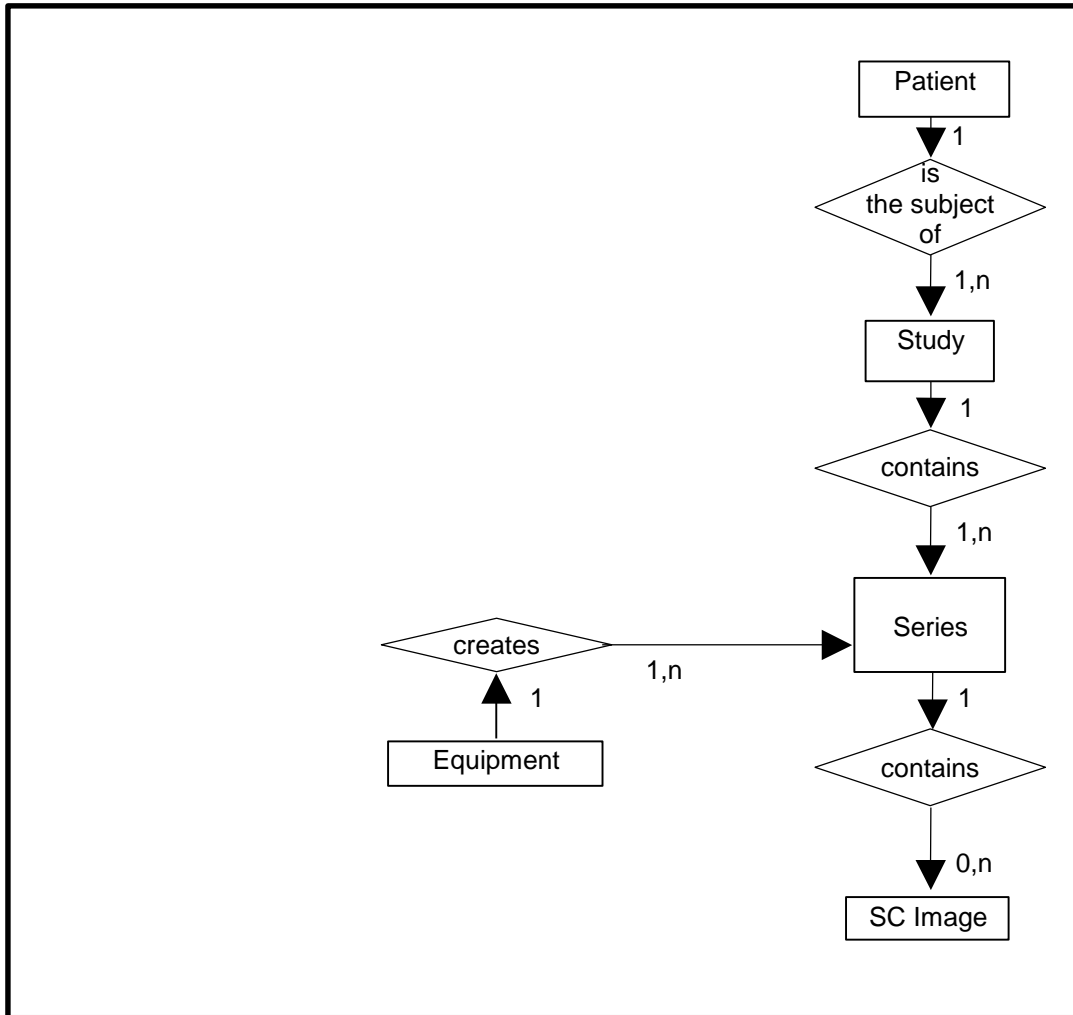

6.3.1 Entity Descriptions

Please refer to DICOM Standard Part 3 (Information Object Definitions) for a description of each of the entities contained within the SC Information Object.

6.3.2 Vivid v203 Mapping of DICOM Entities

TABLE 6.3-1
MAPPING OF DICOM ENTITIES TO VIVID v203 ENTITIES

DICOM	Vivid v203 Entity
Patient	Patient
Study	Exam
Series	Exam
Image	Image
Frame	Not Applicable

6.4 IOD MODULE TABLE

Within an entity of the DICOM SC IOD, attributes are grouped into related set of attributes. A set of related attributes is termed a module. A module facilitates the understanding of the semantics concerning the attributes and how the attributes are related with each other. A module grouping does not infer any encoding of information into datasets.

Table 6.4-1 identifies the defined modules within the entities, which comprise the DICOM SC IOD. Modules are identified by Module Name.

See DICOM Part 3 for a complete definition of the entities, modules, and attributes.

TABLE 6.4-1
SC IMAGE IOD MODULES

Entity Name	Module Name	Reference
Patient	Patient	4.5.1.1
Study	General Study	4.5.2.1
	Patient Study	4.5.2.2
Series	General Series	4.5.3.1
Equipment	General Equipment	4.5.4.1
	SC Equipment	6.5.1.1
Image	General Image	4.5.5.1
	Image Pixel	4.5.5.2
	SC Image	6.5.1.2
	Overlay Plane	Not used
	Modality LUT	Not used
	VOI LUT	4.5.5.5
	SOP Common	4.5.6.1

6.5 INFORMATION MODULE DEFINITIONS

Please refer to DICOM Standard Part 3 (Information Object Definitions) for a description of each of the entities and modules contained within the SC Information Object.

The following modules are included to convey Enumerated Values, Defined Terms, and Optional Attributes supported. Type 1 & Type 2 Attributes are also included for completeness and to define what values they may take and where these values are obtained. It should be noted that they are the same ones as defined in the DICOM Standard Part 3 (Information Object Definitions).

6.5.1 SC Modules

This Section describes SC Equipment, and Image Modules. These Modules contain attributes that are specific to SC Image IOD.

6.5.1.1 SC Equipment Module

This Module describes equipment used to convert images into a DICOM format.

**TABLE 6.5-2
SC IMAGE EQUIPMENT MODULE ATTRIBUTES**

Attribute Name	Tag	Type	Attribute Description
Conversion Type	(0008,0064)	1	Set to WSD
Modality	(0008,0060)	3	Defined Value "US" used.
Secondary Capture Device ID	(0018,1010)	3	Is set to the model name of the Vivid scanner. For example, "Vivid E95" for the Vivid E95 model.
Secondary Capture Device Manufacturer	(0018,1016)	3	Implementation defined string "GE Vingmed Ultrasound"
Secondary Capture Device Manufacturer's Model Name	(0018,1018)	3	Is set to the model name of the Vivid scanner. For example, "Vivid E95" for the Vivid E95 model.
Secondary Capture Device Software Version	(0018,1019)	3	Is set to Vivid v203 software version
Video Image Format Acquired	(0018,1022)	3	Not used
Digital Image Format Acquired	(0018,1023)	3	Not used

6.5.1.2 SC Image Module

The table in this Section contains IOD attributes that describe SC images.

**TABLE 6.5-3
SC IMAGE MODULE ATTRIBUTES**

Attribute Name	Tag	Type	Attribute Description
Date of Secondary Capture	(0018,1012)	3	Image capture date
Time of Secondary Capture	(0018,1014)	3	Image capture time

7. SR INFORMATION OBJECT IMPLEMENTATION

Note: If “Use older SR version” is enabled (see 2.6 and 3.6) the corresponding DICOM Conformance Statement of the selected model and version should be used. The Conformance Statement can be found in a link available in the references section of this document (section 1.6).

7.1 INTRODUCTION

This section specifies the use of the DICOM Comprehensive SR IOD to represent results produced by this implementation. Corresponding attributes are conveyed using the module construct. The contents of this section are:

7.2- IOD Implementation

7.3 - IOD Entity-Relationship Model

7.4 - IOD Module Table

7.5 - IOD Module Definition

In this section, supported means that tag is sent with value.

7.2 COMPREHENSIVE SR IOD IMPLEMENTATION

This section defines the implementation of Comprehensive SR information object.

7.3 COMPREHENSIVE SR ENTITY-RELATIONSHIP MODEL

The Entity-Relationship diagram for the Comprehensive SR interoperability schema is shown in Illustration 4.3-1. In this figure, the following diagrammatic convention is established to represent the information organization:

- each entity is represented by a rectangular box
- each relationship is represented by a diamond shaped box.
- the fact that a relationship exists between two entities is depicted by lines connecting the corresponding entity boxes to the relationship boxes.

The relationships are fully defined with the maximum number of possible entities in the relationship shown. In other words, the relationship between Series and SR Documents can have up to n SR Documents per Series, but the Patient to Study relationship has 1 Patient for each Study (a Patient can have more than one Study on the system, however each Study will contain all of the information pertaining to that Patient).

ILLUSTRATION 7.3-1
COMPREHENSIVE SR ENTITY RELATIONSHIP DIAGRAM

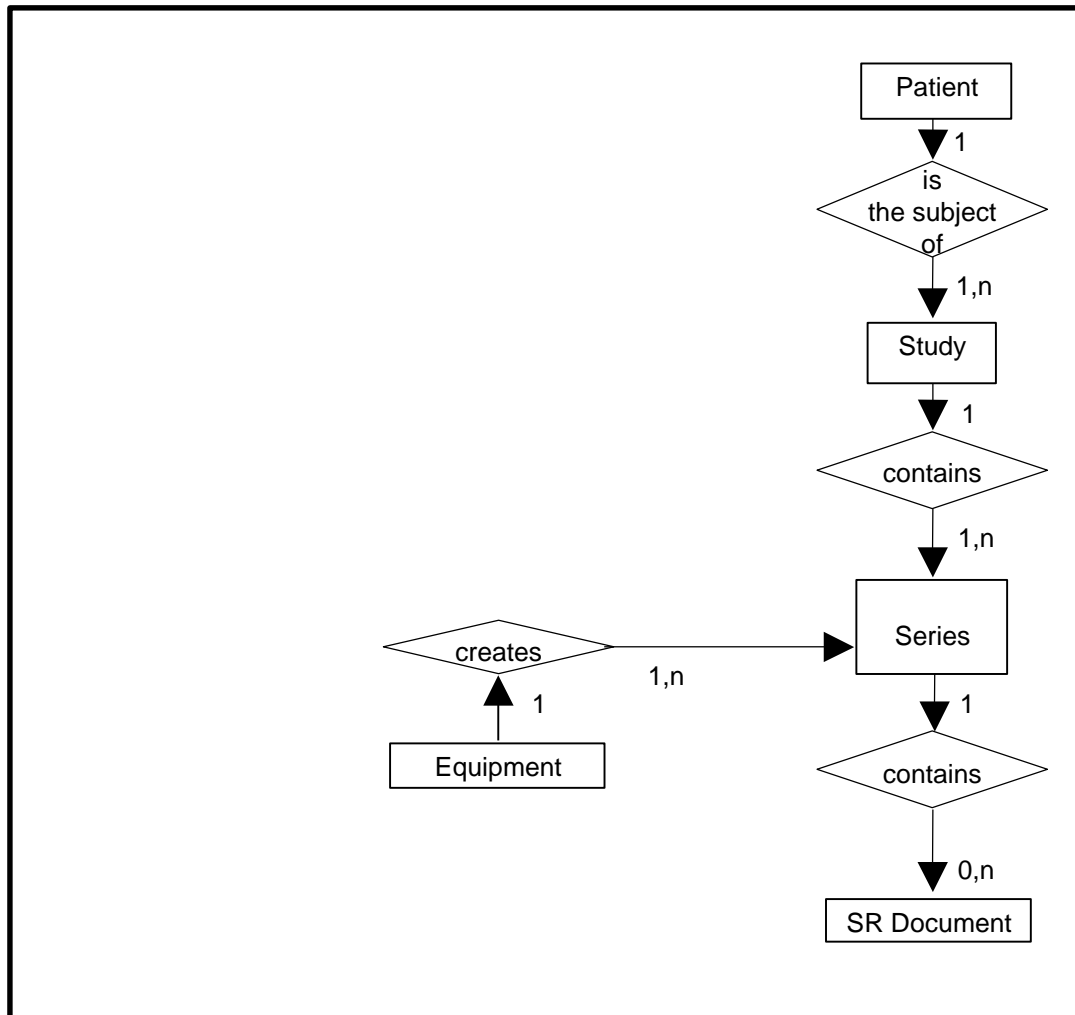

7.3.1 Entity Descriptions

Please refer to DICOM Standard Part 3 (Information Object Definitions) for a description of each of the entities contained within the Comprehensive SR Information Object.

7.3.2 Vivid v203 Mapping of DICOM Entities

TABLE 7.3-1
MAPPING OF DICOM ENTITIES TO VIVID v203 ENTITIES

DICOM	Vivid v203 Entity
Patient	Patient
Study	Exam
Series	Exam
SR Document	Results

7.4 IOD MODULE TABLE

Within an entity of the DICOM Comprehensive SR IOD, attributes are grouped into related set of attributes. A set of related attributes is termed a module. A module facilitates the understanding of the semantics concerning the attributes and how the attributes are related with each other. A module grouping does not infer any encoding of information into data sets.

Table 4.4-1 identifies the defined modules within the entities, which comprise the DICOM Comprehensive SR IOD. Modules are identified by Module Name.

See DICOM Part 3 for a complete definition of the entities, modules, and attributes.

TABLE 7.4-1
COMPREHENSIVE SR IMAGE IOD MODULES

Entity Name	Module Name	Reference
Patient	Patient	4.5.1.1
	Specimen Identification	Not used
Study	General Study	4.5.2.1
	Patient Study	4.5.2.2
Series	SR Document Series	7.5.1
Equipment	General Equipment	4.5.4.1
Document	SR Document General	7.5.2
	SR Document Content	7.5.3
	SOP Common	4.5.6.1

7.5 INFORMATION MODULE DEFINITIONS

Please refer to DICOM Standard Part 3 (Information Object Definitions) for a description of each of the entities and modules contained within the Comprehensive SR Information Object.

The following modules are included to convey Enumerated Values, Defined Terms, and Optional Attributes supported. Type 1 & Type 2 Attributes are also included for completeness and to define what values they may take and where these values are obtained. It should be noted that they are the same ones as defined in the DICOM Standard Part 3 (Information Object Definitions).

7.5.1 SR Document Series Module

TABLE 7.5-1
SR DOCUMENT SERIES MODULE

Attribute Name	Tag	Type	Attribute Description
Modality	(0008,0060)	1	Defined Term "SR" used.
Series Instance UID	(0020,000E)	1	Uniquely generated by the equipment
Series Number	(0020,0011)	1	Internal number which is incremented for each new series within a study.
Series Date	(0020,0021)	3	Not used
Series Time	(0020,0031)	3	Not used
Series Description	(0020,103E)	3	Not used
Referenced Performed Procedure Step Sequence	(0008,1111)	2	Used if Modality Performed Procedure Step is enabled.
>Referenced SOP Class UID	(0008,1150)	1	Used if Modality Performed Procedure Step is enabled.
>Referenced SOP Instance UID	(0008,1155)	1	Used if Modality Performed Procedure Step is enabled.

7.5.2 SR Document General Module

TABLE 7.5-2
SR DOCUMENT GENERAL MODULE

Attribute Name	Tag	Type	Attribute Description
Instance Number	(0020,0013)	1	Internal number which is incremented for each new SR document within a series.
Completion Flag	(0040,A491)	1	Defined Term "PARTIAL" used.
Completion Flag Description	(0040,A492)	3	Not used
Verification Flag	(0040,A493)	1	Defined Term "UNVERIFIED" used.
Content Date	(0008,0023)	1	Date of creation
Content Time	(0008,0033)	1	Time of creation
Verifying Observer Sequence	(0040,A073)	1C	Not used
>Verifying Observer Name	(0040,A075)	1	
>Verifying Observer Identification Code Sequence	(0040,A088)	2	
>>Include 'Code Sequence Macro'			
>Verifying Organization	(0040,A027)	1	
>Verification DateTime	(0040,A030)	1	
Predecessor Documents Sequence	(0040,A360)	1C	Not used.

>Include 'SOP Instance Reference Macro'			
Identical Documents Sequence	(0040,A525)	1C	Not used
>Include 'SOP Instance Reference Macro'			
Referenced Request Sequence	(0040,A370)	1C	
>Study Instance UID	(0020,000D)	1	Taken from Study Instance UID in General Study Module
>Referenced Study Sequence	(0008,1110)	2	Always empty
>>Referenced SOP Class UID	(0008,1150)	1	
>>Referenced SOP Instance UID	(0008,1155)	1	
>Accession Number	(0008,0050)	2	Taken from Accession Number in General Study Module
>Placer Order Number/Imaging Service Request	(0040,2016)	2	Always empty
>Filler Order Number/Imaging Service Request	(0040,2017)	2	Always empty
>Requested Procedure ID	(0040,1001)	2	Taken from worklist if it is there
>Requested Procedure Description	(0032,1060)	2	Taken from worklist if it is there
>Requested Procedure Code Sequence	(0032,1064)	2	Always empty
>>Include 'Code Sequence Macro'			
Performed Procedure Code Sequence	(0040,A372)	2	Always empty
>Include 'Code Sequence Macro'			
Current Requested Procedure Evidence Sequence	(0040,A375)	1C	Not used.
>Study Instance UID	(0020,000D)	1	
>Referenced Series Sequence	(0008,1115)	1	
>>Series Instance UID	(0020,000E)	1	
>>Retrieve AE Title	(0008,0054)	3	Not used
>>Storage Media File-Set ID	(0088,0130)	3	Not used
>>Storage Media File-Set UID	(0088,0140)	3	Not used
>>Referenced SOP Sequence	(0008,1199)	1	
>>>Referenced SOP Class UID	(0008,1150)	1	
>>>Referenced SOP Instance UID	(0008,1155)	1	
Pertinent Other Evidence Sequence	(0040,A385)	1C	Not used
>Include 'SOP Instance Reference Macro'			

7.5.3 SR Document Content Module

The SR Document Content Module is described in the following table.

**TABLE 7.5-2
SR DOCUMENT CONTENT MODULE ATTRIBUTES**

Attribute Name	Tag	Type	Attribute Description
Observation DateTime	(0040,A032)	1C	Not used
Content Template Sequence	(0040,A504)	1C	Template id 5200 or 5100 or 5220 from DCMR.
> <i>'Template Identification Macro'</i>			
Value Type	(0040,A040)	1	CONTAINER
Continuity of Content	(0040,A050)	1C	SEPARATE
Concept Name Code Sequence	(0040,A043)	1C	“Adult Echocardiography Procedure Report” or “Vascular Ultrasound Procedure Report” or “Pediatric Cardiac Ultrasound Report”
> <i>'Code Sequence Macro'</i>			
<i>Concept Value attribute(s)</i>			Not used for CONTAINER
Content Sequence	(0040,A730)	1C	See template “Adult Echocardiography Procedure Report” or “Vascular Ultrasound Procedure Report”.
> Relationship Type	(0040,A010)	1	See template “Adult Echocardiography Procedure Report” or “Vascular Ultrasound Procedure Report”.
> Referenced Content Item Identifier	(0040,DB73)	1C	Not used
> <i>SR Document Content Module</i>			See template “Adult Echocardiography Procedure Report” and “Vascular Ultrasound Procedure Report”.

SR Document on template “Pediatric Cardiac Ultrasound Report” is created if there are measurements in “Pediatric” M&A categories.

SR Document on template “Adult Echocardiography Procedure Report” is created if there are measurements in “Cardiac” and no measurements in “Pediatric” M&A categories.

SR Document on template “Vascular Ultrasound Procedure Report” is created if there are measurements in “Vascular” or “Abdomen” M&A categories.

If there are measurements from both “Cardiac/Pediatric” and “Vascular” category groups, both SR Documents will be created.

7.5.3.1 SR Document Content Descriptions

7.5.3.1.1 Content Template

Vivid v203 supports the following root Templates for SR SOP Instances created by Vivid v203.

**TABLE 7.5-3
SR ROOT TEMPLATES**

SOP Class	Template ID	Template Name	Use
Comprehensive SR	5200	“Adult Echocardiography Procedure Report”	Create
Comprehensive SR	5100	“Vascular Ultrasound Procedure Report”	Create
Comprehensive SR	5220	“Pediatric Cardiac Ultrasound Report”	Create

The mappings from the product’s internal measurement names to DICOM SR encoding are in chapters 14 and 15.

7.6 STANDARD EXTENDED AND PRIVATE DATA ATTRIBUTES

If so configured, the product will send exam information in private data elements designated by the Private Creator element:

Element Name	Tag	VR	VM	Description
Private Creator	6005,xxxx	LO	1	GEMS_Ultrasound_ExamGroup_001

This means that all private tags starting with 6005,xxxx will belong to the GEMS_Ultrasound_ExamGroup_001.

7.7 STANDARD EXTENDED AND PRIVATE CONTEXT GROUPS

The product uses the standard extended context groups as described in chapters 14 and 15

7.8 STANDARD EXTENDED AND PRIVATE TEMPLATES

The product uses the standard extended templates as described in chapters 14 and 15

7.8.1 Standard Extended Templates

The product uses the standard extended templates as described in chapters 14 and 15

7.8.2 Private Templates

Not applicable.

7.8.3 Additional Private Element information

The Vivid can be configured to export recorded measurements within an XML formatted payload located within a Private Data Element. The XML may contain additional measurements not part of the Public DICOM payload. The element is located within group and element number (6005,1030).

The structure of the XML object is intended to maintain the DICOM hierarchy of Patient->Study->Series->Object where possible to remain readable.

A simplified example of the XML data hierarchy is provided within TABLE 7.8.3.1

TABLE 7.8.3.1 SIMPLIFIED EXAMPLE OF XML PRIVATE ELEMENT

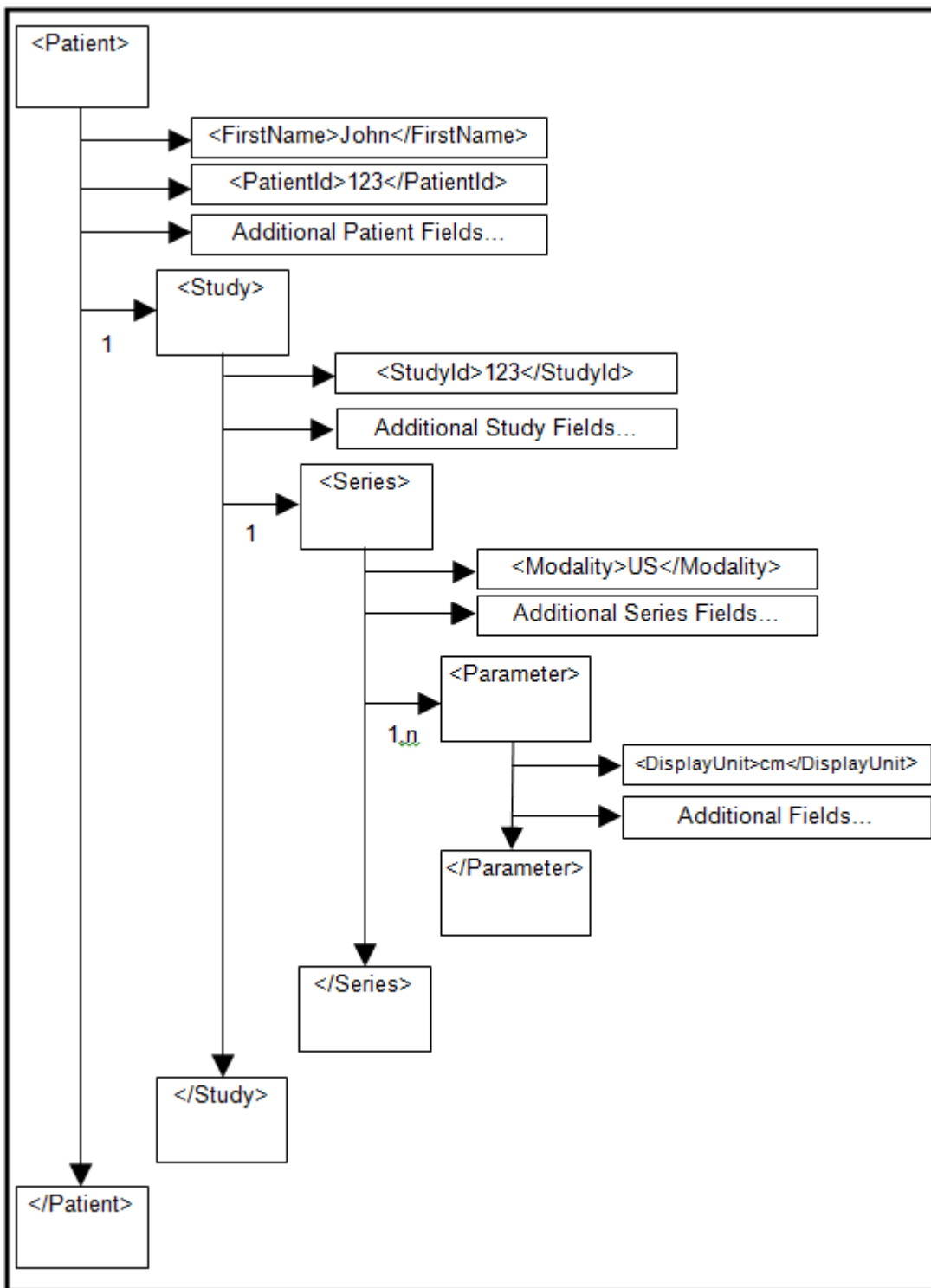

An example of a Measurement, or Parameter, formatted for XML is provided within table 7.8.3.2.

TABLE 7.8.3.2
MEASUREMENT XML EXAMPLE

```
<Parameter>
  <AverageType>A</AverageType>
  <Category>C</Category>
  <DisplayUnit>cm</DisplayUnit>
  <Edited>>false</Edited>
  <ExcludedFromAvg>>false</ExcludedFromAvg>
  <ExcludedFromCalc>>false</ExcludedFromCalc>
  <MeasureId>Cardiac/2D/Ao/LA/LA/Ao</MeasureId>
  <ParameterId>2D/LA</ParameterId>
  <ParameterName>LA Diam</ParameterName>
  <ResultNo>-1</ResultNo>
  <ResultValue>1.001</ResultValue>
  <ScanMode>2D</ScanMode>
  <StudyId>Cardiac/2D/Ao/LA</StudyId>
  <ParameterType>M</ParameterType>
  <DisplayValue>100.1</DisplayValue>
</Parameter>
```

8. BASIC DIRECTORY INFORMATION OBJECT IMPLEMENTATION

8.1 INTRODUCTION

This section specifies the use of the DICOM Basic Directory IOD to represent the information included in directories produced by this implementation. Corresponding attributes are conveyed using the module construct. The contents of this section are:

8.2 - IOD Implementation

8.3 - IOD Entity-Relationship Model

8.4- IOD Module Table

8.5 - IOD Module Definition

8.2 BASIC DIRECTORY IOD IMPLEMENTATION

This section defines the implementation of Basic Directory information object.

8.3 BASIC DIRECTORY ENTITY-RELATIONSHIP MODEL

The Entity-Relationship diagram for the Basic Directory interoperability schema is shown in Illustration 8.3-1. In this figure, the following diagrammatic convention is established to represent the information organization:

- each entity is represented by a rectangular box
- each relationship is represented by a diamond shaped box
- the fact that a relationship exists between two entities is depicted by lines connecting the corresponding entity boxes to the relationship boxes.

8.3.1 Vivid v203 Mapping of DICOM entities

TABLE 8.3-1
MAPPING OF DICOM ENTITIES TO VIVID v203 ENTITIES

DICOM	Vivid v203
Patient	Patient
Study	Exam
Series	Exam
Image or SR Document	Image or Results

ILLUSTRATION 8.3-1
BASIC DIRECTORY ENTITY RELATIONSHIP DIAGRAM

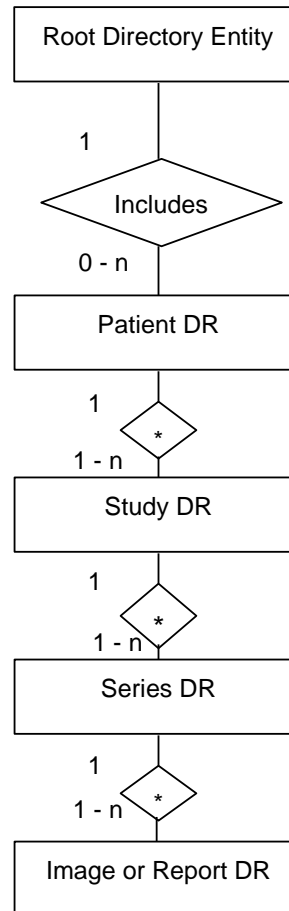

8.4 IOD MODULE TABLE

Within an entity of the Basic Directory IOD, attributes are grouped into related set of attributes. A set of related attributes is termed a module. A module facilitates the understanding of the semantics concerning the attributes and how the attributes are related with each other. A module grouping does not infer any encoding of information into datasets.

Table 8.4-1 identifies the defined modules within the entities, which comprise the Basic Directory IOD. Modules are identified by Module Name.

See DICOM Part 3 for a complete definition of the entities, modules, and attributes.

**TABLE 8.4-1
BASIC DIRECTORY IOD MODULES**

Entity Name	Module Name	Reference
File Set Identification	File Set Identification	8.5.1.1
Directory Information	Directory Information	8.5.2.1

The Directory Information Module is created when initializing the media. If it already exists, the existing information is not changed regarding patient, study, series or image/result data.

An existing Directory Information Module may have been obtained from application entities using removable media. These instances are external to this conformance claim and the origin of the SOP instances is outside the scope of this claim.

8.5 INFORMATION MODULE DEFINITIONS

Please refer to DICOM Standard Part 3 (Information Object Definitions) for a description of each of the entities and modules contained within the Basic Directory Information Object.

The following modules are included to convey Enumerated Values, Defined Terms, and Optional Attributes supported. Type 1 & Type 2 Attributes are also included for completeness and to define what values they may take and where these values are obtained. It should be noted that they are the same ones as defined in the DICOM Standard Part 3 (Information Object Definitions).

8.5.1 Common File Set identification Modules

8.5.1.1 File Set identification Module

**TABLE 8.5-1
FILE-SET IDENTIFICATION MODULE**

Attribute Name	Tag	Type	Attribute Description
File-set ID	(0004,1130)	2	Has NULL value
File-set Descriptor File ID	(0004,1141)	3	Not used
Specific Character Set of File-set Descriptor File	(0004,1142)	1C	Not used

8.5.2 Common Directory Information Modules

8.5.2.1 Directory Information Module

**TABLE 8.5-2
DIRECTORY INFORMATION MODULE**

Attribute Name	Tag	Type	Attribute Description
Offset of the First Directory Record of the Root Directory Entity	(0004,1200)	1	Is set
Offset of the Last Directory Record of the Root Directory Entity	(0004,1202)	1	Is set

Attribute Name	Tag	Type	Attribute Description
File-set Consistency Flag	(0004,1212)	1	FSC/FSU: Has the value 0000H: no known inconsistencies, ignored when reading
Directory Record Sequence	(0004,1220)	2	Is created by FSC
>Offset of the Next Directory Record	(0004,1400)	1	Is set
>Record In-use Flag	(0004,1410)	1	FSC/FSR: Is set to FFFFH FSR: A value of 0000H: imply skipping this record
>Offset of Referenced Lower-Level Directory Entity	(0004,1420)	1	Is set
>Directory Record Type	(0004,1430)	1	The values support by FSC and FSU are PATIENT STUDY SERIES IMAGE SR DOCUMENT
>Private Record UID	(0004,1432)	1C	Not used
>Referenced File ID	(0004,1500)	1C	Is set if Directory Record Type is IMAGE or SR DOCUMENT Contains the file path consisting of 5 elements: 1. "GEMS_IMG" (if IMAGE) or "GEMS_REP" (if SR DOCUMENT) 2. Month of exam 3. Day of exam 4. Patient initials and time of exam 5. Time stamp
>Referenced SOP Class UID in File	(0004,1510)	1C	Is set to the SOP class UID in File if Directory Record Type is IMAGE or SR DOCUMENT
>Referenced SOP Instance UID in File	(0004,1511)	1C	Is set to the SOP instance UID in File if Directory Record Type is IMAGE or SR DOCUMENT
>Referenced Transfer Syntax UID in File	(0004,1512)	1C	Is set to the Transfer Syntax UID in File if Directory Record Type is IMAGE or SR DOCUMENT
>Record Selection Keys			See 8.5.3.

8.5.3 Definition of Specific Directory Records

8.5.3.1 Patient Directory Record Definition

TABLE 8.5-3
PATIENT KEYS

Key	Tag	Type	Attribute Description
Specific Character Set	(0008,0005)	1C	Is filled in by FSC and FSU as in chapter 4, 5, 6 and 7.
Patient's Name	(0010,0010)	2	Is filled in by FSC and FSU as in chapter 4, 5, 6 and 7.
Patient ID	(0010,0020)	1	Is filled in by FSC and FSU as in chapter 4, 5, 6 and 7. If empty, a Patient Id is created by the equipment.
Patient's Birth Date	(0010,0030)	3	Is filled in by FSC and FSU as in chapter 4, 5, 6 and 7.
Patient's Sex	(0010,0040)	3	Is filled in by FSC and FSU as in chapter 4, 5, 6 and 7.
Referenced Patient Sequence	(0008,1120)	3	Is filled in by FSC and FSU as in chapter 4, 5, 6 and 7.
>Referenced SOP Class UID	(0008,1150)	1	Is filled in by FSC and FSU as in chapter 4, 5, 6 and 7.
>Referenced SOP Instance UID	(0008,1155)	1	Is filled in by FSC and FSU as in chapter 4, 5, 6 and 7.
Patient's Birth Time	(0010,0032)	3	Is filled in by FSC and FSU as in chapter 4, 5, 6 and 7.
Other Patient Ids	(0010,1000)	3	Is filled in by FSC and FSU as in chapter 4, 5, 6 and 7.
Other Patient Names	(0010,1001)	3	Is filled in by FSC and FSU as in chapter 4, 5, 6 and 7.
Ethnic Group	(0010,2160)	3	Is filled in by FSC and FSU as in chapter 4, 5, 6 and 7.
Patient Comments	(0010,4000)	3	Is filled in by FSC and FSU as in chapter 4, 5, 6 and 7.

8.5.3.2 Study Directory Record Definition

TABLE 8.5-4
STUDY KEYS

Key	Tag	Type	Attribute Description
Specific Character Set	(0008,0005)	1C	Is filled in by FSC and FSU as in chapter 4, 5, 6 and 7.
Study Instance UID	(0020,000D)	1C	Is filled in by FSC and FSU as in chapter 4, 5, 6 and 7.
Study Date	(0008,0020)	1	Is filled in by FSC and FSU as in chapter 4, 5, 6 and 7. If empty, a Study Date is created by the equipment.

Key	Tag	Type	Attribute Description
Study Time	(0008,0030)	1	Is filled in by FSC and FSU as in chapter 4, 5, 6 and 7. If empty, a Study Time is created by the equipment.
Referring Physician's Name	(0008,0090)	3	Is filled in by FSC and FSU as in chapter 4, 5, 6 and 7.
Study ID	(0020,0010)	1	Is filled in by FSC and FSU as in chapter 4, 5, 6 and 7. If empty, a Study Id is created by the equipment.
Accession Number	(0008,0050)	2	Is filled in by FSC and FSU as in chapter 4, 5, 6 and 7.
Study Description	(0008,1030)	2	Is filled in by FSC and FSU as in chapter 4, 5, 6 and 7.
Physician(s) of Record	(0008,1048)	3	Is filled in by FSC and FSU as in chapter 4, 5, 6 and 7.
Name of Physician(s) Reading Study	(0008,1060)	3	Is filled in by FSC and FSU as in chapter 4, 5, 6 and 7.
Referenced Study Sequence	(0008,1110)	3	Is filled in by FSC and FSU as in chapter 4, 5, 6 and 7.
>Referenced SOP Class UID	(0008,1150)	1	Is filled in by FSC and FSU as in chapter 4, 5, 6 and 7.
>Referenced SOP Instance UID	(0008,1155)	1	Is filled in by FSC and FSU as in chapter 4, 5, 6 and 7.
Admitting Diagnoses Description	(0008,1080)	3	Is filled in by FSC and FSU as in chapter 4, 5, 6 and 7.
Patient's Age	(0010,1010)	3	Is filled in by FSC and FSU as in chapter 4, 5, 6 and 7.
Patient's Size	(0010,1020)	3	Is filled in by FSC and FSU as in chapter 4, 5, 6 and 7.
Patient's Weight	(0010,1030)	3	Is filled in by FSC and FSU as in chapter 4, 5, 6 and 7.
Occupation	(0010,2180)	3	Is filled in by FSC and FSU as in chapter 4, 5, 6 and 7.
Additional Patient's History	(0010,21B0)	3	Is filled in by FSC and FSU as in chapter 4, 5, 6 and 7.

8.5.3.3 Series Directory Record Definition

TABLE 8.5-5
SERIES KEYS

Key	Tag	Type	Attribute Description
Specific Character Set	(0008,0005)	1C	Is filled in by FSC or FSU as contained in the image or SR document message, if one of the tags contains extended characters
Modality	(0008,0060)	1	Is filled in by FSC and FSU as in chapter 4, 5, 6 and 7.

Key	Tag	Type	Attribute Description
Series Instance UID	(0020,000E)	1	Is filled in by FSC and FSU as in chapter 4, 5, 6 and 7.
Series Number	(0020,0011)	1	Is filled in by FSC and FSU as in chapter 4, 5, 6 and 7. If empty, a Series Number is created by the equipment.
Icon Image Sequence	(0088,0200)	3	Not used.
Series Date	(0008,0021)	3	Is filled in by FSC and FSU as in chapter 4, 5, 6 and 7 if instance is IMAGE.
Series Time	(0008,0031)	3	Is filled in by FSC and FSU as in chapter 4, 5, 6 and 7 if instance is IMAGE.
Performing Physicians' Name	(0008,1050)	3	Is filled in by FSC and FSU as in chapter 4, 5, 6 and 7 if instance is IMAGE.
Protocol Name	(0018,1030)	3	Is filled in by FSC and FSU as in chapter 4, 5, 6 and 7 if instance is IMAGE.
Series Description	(0008,103E)	3	Is filled in by FSC and FSU as in chapter 4, 5, 6 and 7 if instance is IMAGE.
Operator's Name	(0008,1070)	3	Is filled in by FSC and FSU as in chapter 4, 5, 6 and 7 if instance is IMAGE.
Referenced Performed Procedure Step Sequence	(0008,1111)	3	Is filled in by FSC and FSU as in chapter 4, 5, 6 and 7.
>Referenced SOP Class UID	(0008,1150)	1	Is filled in by FSC and FSU as in chapter 4, 5, 6 and 7.
>Referenced SOP Instance UID	(0008,1155)	1	Is filled in by FSC and FSU as in chapter 4, 5, 6 and 7.
Request Attributes Sequence	(0040,0275)	3	Is filled in by FSC and FSU as in chapter 4, 5, 6 and 7 if instance is IMAGE.
>Requested Procedure ID	(0040,1001)	1C	Is filled in by FSC and FSU as in chapter 4, 5, 6 and 7 if instance is IMAGE.
>Scheduled Procedure Step ID	(0040,0009)	1C	Is filled in by FSC and FSU as in chapter 4, 5, 6 and 7 if instance is IMAGE.
>Scheduled Procedure Step Description	(0040,0007)	3	Is filled in by FSC and FSU as in chapter 4, 5, 6 and 7 if instance is IMAGE.
>Scheduled Protocol Code Sequence	(0040,0008)	3	Is filled in by FSC and FSU as in chapter 4, 5, 6 and 7 if instance is IMAGE.

Key	Tag	Type	Attribute Description
>>Include 'Code Sequence Macro'			Is filled in by FSC and FSU as in chapter 4, 5, 6 and 7 if instance is IMAGE.
Performed Procedure Step ID	(0040,0253)	3	Is filled in by FSC and FSU as in chapter 4, 5, 6 and 7 if instance is IMAGE.
Performed Procedure Step Start Date	(0040,0244)	3	Is filled in by FSC and FSU as in chapter 4, 5, 6 and 7 if instance is IMAGE.
Performed Procedure Step Start Time	(0040,0245)	3	Is filled in by FSC and FSU as in chapter 4, 5, 6 and 7 if instance is IMAGE.
Performed Procedure Step Description	(0040,0254)	3	Is filled in by FSC and FSU as in chapter 4, 5, 6 and 7 if instance is IMAGE.
Performed Protocol Code Sequence	(0040,0260)	3	
>Include 'Code Sequence Macro'			Is filled in by FSC and FSU as in chapter 4, 5, 6 and 7 if instance is IMAGE.
Manufacturer	(0008,0070)	2	Is filled in by FSC and FSU as in chapter 4, 5, 6 and 7.
Institution Name	(0008,0080)	3	Is filled in by FSC and FSU as in chapter 4, 5, 6 and 7.
Station Name	(0008,1010)	3	Is filled in by FSC and FSU as in chapter 4, 5, 6 and 7.
Institutional Department Name	(0008,1040)	3	Is filled in by FSC and FSU as in chapter 4, 5, 6 and 7.
Manufacturer's Model Name	(0008,1090)	3	Is filled in by FSC and FSU as in chapter 4, 5, 6 and 7.
Software Versions	(0018,1020)	3	Is filled in by FSC and FSU as in chapter 4, 5, 6 and 7.

8.5.3.4 Image Directory Record Definition

**TABLE 8.5-6
IMAGE KEYS**

Key	Tag	Type	Attribute Description
Specific Character Set	(0008,0005)	1C	Is filled in by FSC and FSU as in chapter 4, 5, 6 and 7.
Instance Number	(0020,0013)	1	Is filled in by FSC and FSU as in chapter 4, 5, 6 and 7. If empty, a Instance Number is created by the equipment.
Icon Image Sequence	(0088,0200)	3	Not used
Content Date	(0008,0023)	3	Is filled in by FSC and FSU as in chapter 4, 5, 6 and 7.
Content Time	(0008,0033)	3	Is filled in by FSC and FSU as in chapter 4, 5, 6 and 7.

Image Type	(0008,0008)	3	Is filled in by FSC and FSU as in chapter 4, 5, 6 and 7.
Rows	(0028,0010)	3	Is filled in by FSC and FSU as in chapter 4, 5, 6 and 7.
Columns	(0028,0011)	3	Is filled in by FSC and FSU as in chapter 4, 5, 6 and 7.
Number Of Frames	(0028,0008)	3	Is filled in by FSC and FSU as in chapter 4, 5, 6 and 7.
Photometric Interpretation	(0028,0004)	3	Is filled in by FSC and FSU as in chapter 4, 5, 6 and 7.
Contrast/Bolus Agent	(0018,0010)	2	Is filled in by FSC and FSU as in chapter 4, 5, 6 and 7.
Lossy Image Compression	(0028,2110)	3	Is filled in by FSC and FSU as in chapter 4, 5, 6 and 7.
Lossy Image Compression Ratio	(0028,2112)	3	Is filled in by FSC and FSU as in chapter 4, 5, 6 and 7.

8.5.3.5 Report Directory Record Definition

TABLE 8.5-7
SR DOCUMENT KEYS

Key	Tag	Type	Attribute Description
Specific Character Set	(0008,0005)	1C	Is filled in by FSC and FSU as in chapter 4, 5, 6 and 7.
Instance Number	(0020,0013)	1	Is filled in by FSC and FSU as in chapter 4, 5, 6 and 7. If empty, a Instance Number is created by the equipment.
Content Date	(0008,0023)	1	Is filled in by FSC and FSU as in chapter 4, 5, 6 and 7.
Content Time	(0008,0033)	1	Is filled in by FSC and FSU as in chapter 4, 5, 6 and 7.
Completion Flag	(0040,A491)	1	Is filled in by FSC and FSU as in chapter 4, 5, 6 and 7.
Verification Flag	(0040,A493)	1	Is filled in by FSC and FSU as in chapter 4, 5, 6 and 7.
Concept Name Code Sequence	(0040,A043)	1	Is filled in by FSC and FSU as in chapter 4, 5, 6 and 7.
Content Sequence	(0040,A730)	1C	Not Used

8.5.3.6 Private Directory Record Definition

Not used.

8.5.3.7 Multi-Referenced File Directory Record Definition

Not used.

8.6 PRIVATE DATA DICTIONARY

If so configured, the product will send ultrasound raw data information in private data elements designated by the Private Creator element:

Element Name	Tag	VR	VM	Description
Private Creator	7FE1,00xx	LO	1	GEMS_Ultrasound_MovieGroup_001

This means that all private tags starting with 7FE1,xx will belong to the GEMS_Ultrasound_MovieGroup_001.

If so configured, the product will send preview image in private data elements designated by the Private Creator element:

Element Name	Tag	VR	VM	Description
Private Creator	6003,00xx	LO	1	GEMS_Ultrasound_ImageGroup_001

This means that all private tags starting with 6003,xx will belong to the GEMS_Ultrasound_ImageGroup_001.

If so configured, the product will send exam information in private data elements designated by the Private Creator element:

Element Name	Tag	VR	VM	Description
Private Creator	6005,00xx	LO	1	GEMS_Ultrasound_ExamGroup_001

This means that all private tags starting with 6005,xx will belong to the GEMS_Ultrasound_ExamGroup_001.

9. MODALITY WORKLIST INFORMATION MODEL DEFINITION

9.1 INTRODUCTION

This section specifies the use of the DICOM Modality Worklist Information Model used to organize data and against which a Modality Worklist Query will be performed. The contents of this section are:

9.2- Information Model Description

9.3- Information Model Entity-Relationship Model

9.4- Information Model Module Table

9.5- Information Model Keys

9.2 MODALITY WORKLIST INFORMATION MODEL DESCRIPTION

This section defines the implementation of Modality Worklist Information Model.

9.3 MODALITY WORKLIST INFORMATION MODEL ENTITY-RELATIONSHIP MODEL

The Entity-Relationship diagram for the Modality Worklist Information Model schema is shown in Illustration 9.3-1. It represents the information that composes a Worklist Item. In this figure, the following diagrammatic convention is established to represent the information organization:

- Each entity is represented by a rectangular box.
- Each relationship is represented by a diamond shaped box.
- The fact that a relationship exists between two entities is depicted by lines connecting the corresponding entity boxes to the relationship boxes.

ILLUSTRATION 9.3-1
MODALITY WORKLIST INFORMATION MODEL E/R DIAGRAM

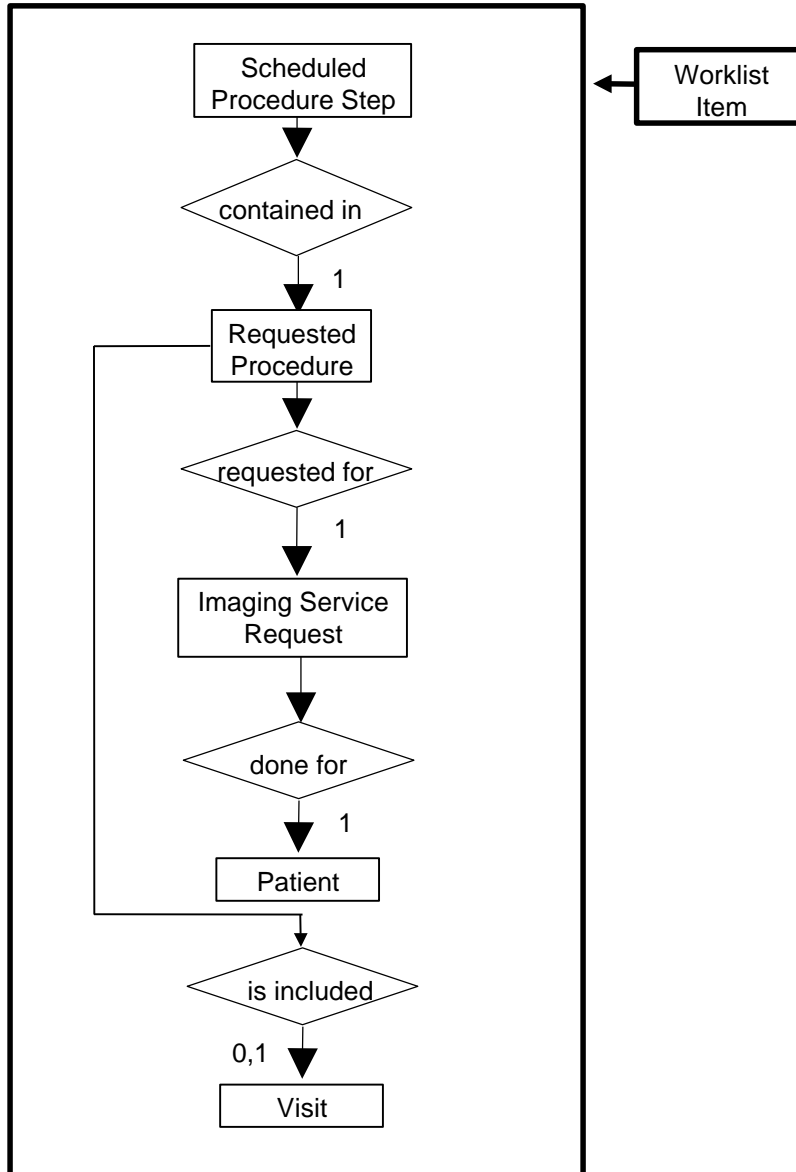

9.3.1 Entity Descriptions

Please refer to DICOM Standard PS 3.3. (Information Object Definitions) and PS 3.4 (Service Class Specifications) for a description of each of the Entities contained within the Modality Worklist Information Model.

9.3.1.1 Scheduled Procedure Step

Schedule Procedure Step is implemented in a basic form to allow for the user to retrieve a subset of attributes.

9.3.1.2 Requested Procedure Entity Description

Requested Procedure Step is implemented in a basic form to allow for the user to retrieve a subset of attributes.

9.3.1.3 Imaging Service Request Entity Description

Image Service is implemented in a basic form to allow for the user to retrieve a subset of attributes.

9.3.1.4 Visit Entity Description

Visit Entity is implemented in a basic form to allow for the user to retrieve a subset of attributes.

9.3.1.5 Patient Entity Description

Patient Entity Description is implemented in a basic form to allow for the user to retrieve a subset of attributes.

9.3.2 Vivid v203 Mapping of DICOM entities

**TABLE 9.3-1
MAPPING OF DICOM ENTITIES TO VIVID v203 ENTITIES**

DICOM	Vivid v203 Entity
Scheduled Procedure Step	Worklist entry
Requested Procedure	Exam
Imaging Service Request	Exam
Visit	Not Applicable
Patient	Patient

9.4 INFORMATION MODEL MODULE TABLE

Within an entity of the DICOM Modality Worklist Information Model, attributes are grouped into related set of attributes. A set of related attributes is termed a module. A module facilitates the understanding of the semantics concerning the attributes and how the attributes are related with each other. A module grouping does not infer any encoding of information into datasets.

Table 9.4-1 identifies the defined modules within the entities that comprise the DICOM Modality Worklist Information Model. Modules are identified by Module Name.

See DICOM PS 3.3 and PS 3.4 for a complete definition of the entities, modules, and attributes.

**TABLE 9.4-1
MODALITY WORKLIST INFORMATION MODEL MODULES**

Entity Name	Module Name	Reference
Scheduled Procedure Step	SOP Common	9.5.2.1
	Scheduled Procedure Step	9.5.2.2
Requested Procedure	Requested Procedure	9.5.3.1
Imaging Service Request	Imaging Service Request	9.5.4.1
Visit	Visit Identification	9.5.5.1
	Visit Status	9.5.5.2
	Visit Relationship	9.5.5.3
	Visit Admission	Not Used
Patient	Patient Relationship	Not Used
	Patient Identification	9.5.6.1
	Patient Demographic	9.5.6.2
	Patient Medical	9.5.6.3

9.5 INFORMATION MODEL KEYS

Please refer to DICOM Standard PS 3.3. (Information Object Definitions) and PS 3.4 (Service Class Specifications) for a description of each of the Entities contained within the Modality Worklist Information Model.

The following Module descriptions are included to specify what data elements are supported and what type of matching can be applied. It should be noted that they are the same ones as defined in the DICOM Standard PS 3.4 (Service Class Specifications).

The term Instance is used for Images and Results in examinations that are based on Worklist entries. Please note that tags that are not defined for SR documents will not be mapped (see Section 7).

9.5.1 Supported Matching

Following are the types of matching that can be requested by the implementation:

- Single Value Matching.
- Wild Card Matching.
- Range of date.

Fields with “Filtering is supported” in the Matching column can be controlled from the Search screen. This means that the user can filter the downloaded C-FIND result, to view a limited set of the result.

All non-required matching fields can be configured in Config screen to be either enabled, enabled with a constant value or disabled. The constant value will be used as entered by user.

Wild Card Matching is only used for Patient’s Name (0010,0010).

9.5.2 Scheduled Procedure Step Entity

9.5.2.1 SOP Common Module

TABLE 9.5-1
SOP COMMON MODULE ATTRIBUTES

Attribute Name	Tag	Expected Matching Key Type	Expected Returned Key Type	Mapped into Instance/MPP S	Matching
Specific Character Set	(0008,0005)	O	1C	Yes/Yes	Attribute is supported if the query contains matching keys in other than the default character repertoire. ISO_IR 100 is supported in responses.

9.5.2.2 Scheduled Procedure Step Module

TABLE 9.5-2
SCHEDULED PROCEDURE STEP MODULE ATTRIBUTES

Attribute Name	Tag	Expected Matching Key Type	Expected Returned Key Type	Mapped into Instance/MPP S	Matching
Scheduled Procedure Step Sequence	(0040,0100)	R	1	No/No	Matching is supported.
>Scheduled Station AE Title	(0040,0001)	R	1	No/No	Matching is supported.
>Scheduled Procedure Step Start Date	(0040,0002)	R	1	No/No	Matching is supported. Filtering is supported.
>Scheduled Procedure Step Start Time	(0040,0003)	R	1	No/No	Matching is supported.
>Modality	(0008,0060)	R	1	Yes/Yes (Only "US" and "SR" are supported)	Matching is supported.
>Scheduled Performing Physician's Name	(0040,0006)	R	2	Yes/Yes (to Performing Physician's Name)	Matching is supported.
>Scheduled Procedure Step Description	(0040,0007)	O	1C	Yes/Yes	Matching is supported.
>Scheduled Station Name	(0040,0010)	O	2	No/No	Matching is supported.

>Scheduled Procedure Step Location	(0040,0011)	O	2	No/No	Matching is supported.
>Scheduled Procedure Step ID	(0040,0009)	O	1	Yes/Yes	Matching is supported.
>Scheduled Protocol Code Sequence	(0040,0008)	O	1C	Yes/Yes	Matching is supported.

9.5.3 Requested Procedure Entity

9.5.3.1 Requested Procedure Module

TABLE 9.5-3
REQUESTED PROCEDURE MODULE ATTRIBUTES

Attribute Name	Tag	Expected Matching Key Type	Expected Returned Key Type	Mapped into Instance/MP PS	Matching
Requested Procedure ID	(0040,1001)	O	1	Yes/Yes (to Requested Procedure ID and Study ID)	Matching is supported. Filtering is supported.
Requested Procedure Description	(0032,1060)	O	1C	Yes/Yes (to Study Description)	Matching is supported.
Requested Procedure Code Sequence	(0032,1064)	O	1C	No/Yes (to Procedure Code Sequence)	Matching is supported.
Requested Procedure Comments	(0040,1400)	O	3	No/No	Matching is supported.
Study Instance UID	(0020,000D)	O	1	Yes/Yes	Matching is supported.
Referenced Study Sequence	(0008,1110)	O	2	Yes/Yes	Matching is supported.
>Referenced SOP Class UID	(0008,1150)	O	1	Yes/Yes	Matching is supported.
>Referenced SOP Instance UID	(0008,1155)	O	1	Yes/Yes	Matching is supported.
Names of Intended Recipients of Results	(0040,1010)	O	3	Yes/No (to Physician(s) of Record)	Matching is supported.

9.5.4 Imaging Service Request Entity

9.5.4.1 Imaging Service Request Module

TABLE 9.5-4
IMAGING SERVICE REQUEST MODULE ATTRIBUTES

Attribute Name	Tag	Expected Matching Key Type	Expected Returned Key Type	Mapped into Instance/MPP S	Matching
Accession Number	(0008,0050)	O	2	Yes/Yes	Matching is supported. Filtering is supported.
Referring Physician's Name	(0008,0090)	O	2	Yes/No	Matching is supported.
Physician(s) of Record	(0008,1048)	O	3	Yes/No	
Imaging Service Request Comments	(0040,2400)	O	3	No/No	Matching is supported.
Requesting Physician	(0032,1032)	O	2	No/No	Matching is supported.
Requesting Service	(0032,1033)	O	3	No/No	Matching is supported.

9.5.5 Visit Entity

9.5.5.1 Visit Identification

TABLE 9.5-5
VISIT IDENTIFICATION MODULE ATTRIBUTES

Attribute Name	Tag	Expected Matching Key Type	Expected Returned Key Type	Mapped into Instance/MP PS	Matching
Admission ID	(0038,0010)	O	2	Yes/Yes	Matching is supported.

9.5.5.2 Visit Status

TABLE 9.5-6
VISIT STATUS MODULE ATTRIBUTES

Attribute Name	Tag	Expected Matching Key Type	Expected Returned Key Type	Mapped into Instance/MP PS	Matching
----------------	-----	----------------------------	----------------------------	----------------------------	----------

Current Patient Location	(0038,0300)	O	2	No/No	Matching is supported.
--------------------------	-------------	---	---	-------	------------------------

9.5.5.3 Visit Relationship

TABLE 9.5-7

VISIT RELATIONSHIP MODULE ATTRIBUTES

Attribute Name	Tag	Expected Matching Key Type	Expected Returned Key Type	Mapped into Instance/MPP S	Matching
Referenced Patient Sequence	(0008,1120)	O	2	Yes/Yes	Matching is supported.
>Referenced SOP Class UID	(0008,1150)	O	2	Yes/Yes	Matching is supported.
>Referenced SOP Instance UID	(0008,1155)	O	2	Yes/Yes	Matching is supported.

9.5.6 Patient Entity

9.5.6.1 Patient Identification

TABLE 9.5-8

PATIENT IDENTIFICATION MODULE ATTRIBUTES

Attribute Name	Tag	Expected Matching Key Type	Expected Returned Key Type	Mapped into Instance/MP PS	Matching
Patient's Name	(0010,0010)	R	1	Yes/Yes	Matching is supported. Filtering is supported.
Patient ID	(0010,0020)	R	1	Yes/Yes	Matching is supported. Filtering is supported.
Issuer of Patient ID	(0010,0021)	O	3	Yes/No	Matching is supported.
Issuer of Patient ID Qualifiers Sequence	(0010,0024)	O	3	N/A	N/A
>Universal Entity ID	(0040,0032)	O	3	Yes/No	
>Universal Entity ID Type	(0040,0033)	O	1C	Yes/No	
>Identifier Type Code	(0040,0035)	O	3	Yes/No	
Other Patient Ids	(0010,1000)	O	3	Yes/No	Matching is supported. Filtering is supported.

Other Patient Ids Sequence	(0010,1002)	O	3	N/A	N/A
>Patient ID	(0010,0020)	O	1	Yes/No	
>Issuer of Patient ID	(0010,0021)	O	3	Yes/No	
>Issuer of Patient ID Qualifiers Sequence	(0010,0024)	O	3	Yes/No	
>>Universal Entity ID	(0040,0032)	O	3	Yes/No	
>>Universal Entity ID Type	(0040,0033)	O	1C	Yes/No	
>>Identifier Type Code	(0040,0035)	O	3	Yes/No	

9.5.6.2 Patient Demographic

**TABLE 9.5-9
PATIENT DEMOGRAPHIC MODULE ATTRIBUTES**

Attribute Name	Tag	Expected Matching Key Type	Expected Returned Key Type	Mapped into Instance/MP PS	Matching
Patients Birth Date	(0010,0030)	O	2	Yes/Yes	Matching is supported. Filtering is supported.
Patients Birth Time	(0010,0032)	O	3	Yes/No	Matching is supported.
Patient's Sex	(0010,0040)	O	2	Yes/Yes	Matching is supported Filtering is supported.
Patient's Size	(0010,1020)	O	3	Yes/No	Matching is supported.
Patient's Weight	(0010,1030)	O	2	Yes/No	Matching is supported.
Patient's Address	(0010,1040)	O	3	No/No	Matching is supported.
Ethnic Group	(0010,2160)	O	3	Yes/No	Matching is supported.
Patient Comments	(0010,4000)	O	3	Yes/No	Matching is supported.

9.5.6.3 Patient Medical

**TABLE 9.5-10
PATIENT MEDICAL MODULE ATTRIBUTES**

Attribute Name	Tag	Expected Matching Key Type	Expected Returned Key Type	Mapped into Instance/MP PS	Matching
Additional Patient History	(0010,21B0)	O	3	Yes/No	Matching is supported.
Contrast Allergies	(0010,2110)	O	2	No/No	Matching is supported.
Medical Alerts	(0010,2000)	O	2	No/No	Matching is supported.
Pregnancy Status	(0010,21C0)	O	2	No/No	Matching is supported.

10. MODALITY PERFORMED PROCEDURE STEP SOP CLASS DEFINITION

10.1 INTRODUCTION

This section of the DICOM Conformance Statement specifies the Modality Performed Procedure Step SOP Class, the optional attributes and service elements supported, the valid range of values for mandatory and optional attributes, and the status code behavior.

10.2 MODALITY PERFORMED PROCEDURE STEP SOP CLASS DEFINITION

In this section, supported means that tag is sent with value if entered by user or from worklist.

10.2.1 IOD Description

This is the description of the DICOM tags to be sent for Modality Performed Procedure Step SOP class:

Modality Performed Procedure Step Sop Class N-CREATE, N-SET and Final State Attributes

Attribute Name	Tag	Req. Type N-CREATE	Req. Type N-SET
Performed Procedure Step Relationship			
Scheduled Step Attribute Sequence	(0040,0270)	1	Not allowed
>Study Instance UID	(0020,000D)	1	Not allowed
>Referenced Study Sequence	(0008,1110)	2, supported	Not allowed
>>Referenced SOP Class UID	(0008,1150)	1, supported	Not allowed
>>Referenced SOP Instance UID	(0008,1155)	1, supported	Not allowed
>Accession Number	(0008,0050)	2, supported	Not allowed
>Placer Order Number/Imaging Service Request	(0040,2016)	3, not supported	Not allowed
>Filler Order Number/Imaging Service Request	(0040,2017)	3, not supported	Not allowed
>Requested Procedure ID	(0040,1001)	2, supported	Not allowed
>Requested Procedure Description	(0032,1060)	2, supported	Not allowed
>Scheduled Procedure Step ID	(0040,0009)	2, supported	Not allowed
>Scheduled Procedure Step Description	(0040,0007)	2, supported	Not allowed
>Scheduled Protocol Code Sequence	(0040,0008)	2, supported	Not allowed
>>Include 'Code Sequence Macro'			
Patient's Name	(0010,0010)	2, supported	Not allowed
Patient ID	(0010,0020)	2, supported	Not allowed

Attribute Name	Tag	Req. Type N-CREATE	Req. Type N-SET
Patient's Birth Date	(0010,0032)	2, supported	Not allowed
Patient's Sex	(0010,0040)	2, supported	Not allowed
Referenced Patient Sequence	(0008,1120)	2, supported	Not allowed
>Referenced SOP Class UID	(0008,1150)	1, supported	Not allowed
>Referenced SOP Instance UID	(0008,1155)	1, supported	Not allowed
Admission Id	(0038,0010)	3, supported	Not allowed
Performed Procedure Step Information			
Performed Procedure Step ID	(0040,0253)	1	Not allowed
Performed Station AE Title	(0040,0241)	1	Not allowed
Performed Station Name	(0040,0242)	2, supported	Not allowed
Performed Location	(0040,0243)	2, supported (Institution Name, truncated if necessary to 16 characters)	Not allowed
Performed Procedure Step Start Date	(0040,0244)	1	Not allowed
Performed Procedure Step Start Time	(0040,0245)	1	Not allowed
Performed Procedure Step Status	(0040,0252)	1	3, supported
Performed Procedure Step Description	(0040,0254)	2, supported	3, supported
Performed Procedure Type Description	(0040,0255)	2, always empty	3, always empty
Procedure Code Sequence	(0008,1032)	2, supported	3, supported
>Include 'Code Sequence Macro'			
Performed Procedure Step End Date	(0040,0250)	2, always empty	3, supported
Performed Procedure Step End Time	(0040,0251)	2, always empty	3, supported
Performed Procedure Step Discontinuation Reason Code Sequence	(0040,0281)	3, not supported	3, not supported
Image Acquisition Results			
Modality	(0008,0060)	1	Not allowed
Study ID	(0020,0010)	2, supported	Not allowed
Performed Protocol Code Sequence	(0040,0260)	2, supported	3, supported
>Include 'Code Sequence Macro'			
Performed Series Sequence	(0040,0340)	2, always empty	3, supported
>Performing Physician's Name	(0008,1050)		2C, supported
>Protocol Name	(0018,1030)		1C (Required if Sequence Item is present)
>Operator's Name	(0008,1070)		2C, supported

Attribute Name	Tag	Req. Type N-CREATE	Req. Type N-SET
>Series Instance UID	(0020,000E)		1C (Required if Sequence Item is present)
>Series Description	(0008,103E)		2C, supported
>Retrieve AE Title	(0008,0054)		2C, supported
>Referenced Image Sequence	(0008,1140)		2C, supported
>>Referenced SOP Class UID	(0008,1150)		1 (Required if Sequence Item is present)
>>Referenced SOP Instance UID	(0008,1155)		1 (Required if Sequence Item is present)
>Referenced Non-Image Composite SOP Instance Sequence	(0040,0220)		2C, supported
>>Referenced SOP Class UID	(0008,1150)		1 (Required if Sequence Item is present)
>>Referenced SOP Instance UID	(0008,1155)		1 (Required if Sequence Item is present)

10.2.2 Operations

10.2.2.1 Service Class User Behavior

Vivid v203 sends N-CREATE when first image in examination is acquired or when the exam is ended (for the case where there are no images or results).

Vivid v203 sends N-SET after the exam is ended. The N-SET will include all acquired image and result UIDs and the status of COMPLETED or DISCONTINUED.

10.2.2.2 Status Codes

No Service Class specific status values are defined for the N-ACTION Service. See PS 3.7 for general response status codes.

For this SOP class, all status codes with status Refused or Error are treated as failures and terminate the association and operation. All status codes with status Warning or Success are treated as successes.

11. STORAGE COMMITMENT PUSH MODEL SOP CLASS DEFINITION

11.1 INTRODUCTION

This section of the DICOM Conformance Statement specifies the Storage Commitment Push Model SOP Class, the optional attributes and service elements supported, the valid range of values for mandatory and optional attributes, and the status code behavior.

11.2 STORAGE COMMITMENT PUSH MODEL SOP CLASS DEFINITION

11.2.1 IOD Description

11.2.1.1 STORAGE COMMITMENT MODULE

TABLE 11.2-1
STORAGE COMMITMENT MODULE

Attribute Name	Tag	Attribute Description
Transaction UID	(0008,1195)	Uniquely generated by the equipment
Retrieve AE Title	(0008,0054)	Not used
Storage Media File-Set ID	(0088,0130)	Not used
Storage Media File-Set UID	(0088,0140)	Not used
Referenced SOP Sequence	(0008,1199)	Supported
>Referenced SOP Class UID	(0008,1150)	Supported
>Referenced SOP Instance UID	(0008,1155)	Supported
>Retrieve AE Title	(0008,0054)	Not used
>Storage Media File-Set ID	(0088,0130)	Not used
>Storage Media File-Set UID	(0088,0140)	Not used
Failed SOP Sequence	(0008,1198)	Supported
>Referenced SOP Class UID	(0008,1150)	Supported
>Referenced SOP Instance UID	(0008,1155)	Supported
>Failure Reason	(0008,1197)	Supported

11.2.2 DIMSE Service Group

DIMSE Service Element	Usage SCU/SCP
N-EVENT-REPORT	M/M
N-ACTION	M/M

11.2.3 Operations

11.2.3.1 Action Information

TABLE 11.2-2
STORAGE COMMITMENT REQUEST - ACTION INFORMATION

Action Type Name	Action Type ID	Attribute	Tag	Requirement Type SCU/SCP
Request Storage Commitment	1	Transaction UID	(0008,1195)	1/1
		Storage Media File-Set ID	(0088,0130)	Not used
		Storage Media File-Set UID	(0088,0140)	Not used
		Referenced SOP Sequence	(0008,1199)	1/1
		>Referenced SOP Class UID	(0008,1150)	1/1
		>Referenced SOP Instance UID	(0008,1155)	1/1
		>Storage Media File-Set ID	(0088,0130)	Not used
		>Storage Media File-Set UID	(0088,0140)	Not used

11.2.3.2 Service Class User Behavior

Vivid v203 sends the N-ACTION primitive (Storage Commitment Request) after successful exam save to a DICOM Storage SCP.

Vivid v203 may request storage commitment for all generated SOP Class UIDs:

Ultrasound Multi-frame Image Storage	1.2.840.10008.5.1.4.1.1.3.1
Ultrasound Multi-frame Image Storage (Retired)	1.2.840.10008.5.1.4.1.1.3
Ultrasound Image Storage	1.2.840.10008.5.1.4.1.1.6.1

Ultrasound Image Storage (Retired)	1.2.840.10008.5.1.4.1.1.6
Secondary Capture Image Storage	1.2.840.10008.5.1.4.1.1.7
Comprehensive Structured Report	1.2.840.10008.5.1.4.1.1.88.33

The association for the N-ACTION is disconnected after processing the response. Thus, the N-EVENT-REPORT must be sent on a separate association.

The Referenced Study Component Sequence Attribute is not supported.

The Transaction UID is valid for two days. If no answer is received, the request will be removed without warning the user.

The optional Storage Media File-Set ID & UID Attributes in the N-ACTION are not supported.

11.2.3.3 Status Codes

No Service Class specific status values are defined for the N-ACTION Service. See PS 3.7 for general response status codes.

For this SOP class, all status codes with status Refused or Error are treated as failures and terminate the association and operation. All status codes with status Warning or Success are treated as successes.

11.2.4 Notifications

Vivid v203 will only listen for an N-EVENT-REPORT from the SCP in a new association on the listen port for Verification and Storage Commitment.

Role Negotiation is supported and expected in the new association requested.

11.2.4.1 Event Information

TABLE 11.2-3
STORAGE COMMITMENT RESULT - EVENT INFORMATION

Event Type Name	Event Type ID	Attribute	Tag	Requirement Type SCU/SCP
Storage Commitment Request Successful	1	Transaction UID	(0008,1195)	-/1
		Retrieve AE Title	(0008,0054)	Not used
		Storage Media File-Set ID	(0088,0130)	Not used
		Storage Media File-Set UID	(0088,0140)	Not used
		Referenced SOP Sequence	(0008,1199)	-/1
		>Referenced SOP Class UID	(0008,1150)	-/1
		>Referenced SOP Instance UID	(0008,1155)	-/1
		>Retrieve AE Title	(0008,0054)	Not used
		>Storage Media File-Set ID	(0088,0130)	Not used
		>Storage Media File-Set UID	(0088,0140)	Not used
Storage Commitment Request Complete - Failures Exist	2	Transaction UID	(0008,1195)	-/1
		Retrieve AE Title	(0008,0054)	Not used
		Storage Media File-Set ID	(0088,0130)	Not used
		Storage Media File-Set UID	(0088,0140)	Not used
		Referenced SOP Sequence	(0008,1199)	-/1C
		>Referenced SOP Class UID	(0008,1150)	-/1
		>Referenced SOP Instance UID	(0008,1155)	-/1
		>Retrieve AE Title	(0008,0054)	Not used
		>Storage Media File-Set ID	(0088,0130)	Not used
		>Storage Media File-Set UID	(0088,0140)	Not used
		Failed SOP Sequence	(0008,1198)	-/1

		>Referenced SOP Class UID	(0008,1150)	-/1
		>Referenced SOP Instance UID	(0008,1155)	-/1
		>Failure Reason	(0008,1197)	-/1

11.2.4.2 Service Class User Behavior

If a successful answer is received, the request will be removed without warning the user.

If a non-successful answer is received, the request will be left in the holding queue.

If no answer is received, the request will be removed without warning the user after two days.

11.2.4.3 Status Codes

No Service Class specific status values are defined for the N-EVENT-REPORT Service. See PS 3.7 for general response status code.

For this SOP class, all status codes with status Refused or Error are treated as failures and terminate the association and operation. All status codes with status Warning or Success are treated as successes.

12. PRINT MANAGEMENT SOP CLASS DEFINITION

12.1 INTRODUCTION

This section of the DICOM Conformance Statement specifies the supported Print Management SOP and Meta SOP Classes, the optional attributes and service elements supported, the valid range of values for mandatory and optional attributes, and the status code behavior.

12.2 - Basic Print Management Meta SOP Classes

12.3 - Print Management SOP Class Definitions

12.4 - Print Management IODs

12.5 - IOD Module Definition

12.2 BASIC PRINT MANAGEMENT META SOP CLASSES

The Basic Print Management Meta SOP Classes correspond with the minimum functionality that an implementation of the Print Management Service Class shall support.

Vivid v203 supports the Basic Grayscale Print Management Meta SOP Class and the Basic Color Print Management Meta SOP Class. These are defined in Table 12.2.1-1 and Table 12.2.2-1.

12.2.1 Basic Grayscale Print Management Meta SOP Class

The Basic Grayscale Print Management Meta SOP Class is defined by the following set of supported SOP Classes.

TABLE 12.2.1-1 BASIC GRAYSCALE PRINT MANAGEMENT META SOP CLASS

SOP Class Name	Usage SCU	Reference
Basic Film Session SOP Class	M	see 12.3.1
Basic Film Box SOP Class	M	see 12.3.2
Basic Grayscale Image Box SOP Class	M	see 12.3.3.1
Printer SOP Class	M	see 12.3.4

12.2.2 Basic Color Print Management Meta SOP Class

The Basic Color Print Management Meta SOP Class is defined by the following set of supported SOP Classes

TABLE 12.2.2-1 BASIC COLOR PRINT MANAGEMENT META SOP CLASS

SOP Class Name	Usage SCU	Reference
Basic Film Session SOP Class	M	see 12.3.1
Basic Film Box SOP Class	M	see 12.3.2
Basic Color Image Box SOP Class	M	see 12.3.3.2
Printer SOP Class	M	see 12.3.4

12.3 PRINT MANAGEMENT SOP CLASS DEFINITIONS

12.3.1 Basic Film Session SOP Class

The Basic Film Session IOD describes the presentation parameters, which are common for all the films of a film session. The DIMSE services that are applicable to the IOD are shown in Table 12.3.1-1.

TABLE 12.3.1-1 DIMSE SERVICE GROUP

DIMSE Service Element	Usage SCU	Reference
N-CREATE	M	see 12.3.1.1.1
N-SET	U	see 12.3.1.1.2
N-DELETE	U	see 12.3.1.1.3
N-ACTION	U	see 12.3.1.1.4

12.3.1.1 DIMSE Service Group

12.3.1.1.1 N-CREATE

The N-CREATE DIMSE Service is used by Vivid v203 to request that the SCP (printer) create a Film Session SOP Instance. Table 12.4.2-1 defines the Basic Film Session Presentation Module attributes used in this request.

12.3.1.1.2 N-SET

Not used in this implementation.

12.3.1.1.3 N-DELETE

Not used in this implementation.

12.3.1.1.4 N-ACTION

Not used in this implementation

12.3.2 Basic Film Box SOP Class

The Basic Film Box IOD is an abstraction of the presentation of one film of the film session. The DIMSE services that are applicable to the IOD are shown in Table 12.3.2-1.

TABLE 12.3.2-1 DIMSE SERVICE GROUP

DIMSE Service Element	Usage SCU	Reference
N-CREATE	M	see 12.3.2.1.1
N-ACTION	M	see 12.3.2.1.2
N-DELETE	U	see 12.3.2.1.3
N-SET	U	see 12.3.2.1.4

12.3.2.1 DIMSE Service Group

12.3.2.1.1 N-CREATE

The N-CREATE DIMSE Service is used by Vivid v203 to request that the SCP create a Film Box SOP Instance. Table 12.4.2-1 defines the Basic Film Box Presentation Module attributes used in this request.

12.3.2.1.2 N-ACTION

The N-ACTION DIMSE Service is used by Vivid v203 to request the SCP (printer) to print the number of copies configured by the user to a film of the film session.

12.3.2.1.3 N-DELETE

The N-DELETE DIMSE Service is used by Vivid v203 to request the SCP (printer) to delete the complete Film Box. The root Film Box Instance UID is sent to the SCP to accomplish this.

12.3.2.1.4 N-SET

Not used in this implementation.

12.3.3 Image Box SOP Class

12.3.3.1 Basic Grayscale Image Box SOP Class

The Basic Grayscale Image Box IOD is an abstraction of the presentation of an image and image related data in the image area of a film. The DIMSE services that are applicable to the IOD are shown in Table 12.3.3-1.

TABLE 12.3.3-1 DIMSE SERVICE GROUP

DIMSE Service Element	Usage SCU	Reference
N-SET	M	see 12.3.3.1.1

12.3.3.1.1 DIMSE Service Group (N-SET)

The N-SET DIMSE Service is used by Vivid v203 to update the Basic Grayscale Image Box SOP Instance. Table 12.5.2-5 defines the Basic Image Box Presentation Module attributes used.

12.3.3.2 Basic Color Image Box SOP Class

The Basic Color Image Box IOD is an abstraction of the presentation of an image and image related data in the image area of a film. The DIMSE services that are applicable to the IOD are shown in Table 12.3.3-2.

TABLE 12.3.3-2 DIMSE SERVICE GROUP

DIMSE Service Element	Usage SCU	Reference
N-SET	M	see 12.3.3.2.1

12.3.3.2.1 DIMSE Service Group (N-SET)

The N-SET DIMSE Service is used by Vivid v203 to update the Basic Color Image Box SOP Instance. Table 12.5.2-5 defines the Basic Image Box Presentation Module attributes used.

12.3.4 Printer SOP Class

The Printer IOD is an abstraction of the hard copy printer and is the basic Information Entity to monitor the status of the printer. The DIMSE services that are applicable to the IOD are shown in table 11.3.4-1.

12.3.4.1 DIMSE Service Group

TABLE 12.3.4-1 DIMSE SERVICE GROUP

DIMSE Service Element	Usage SCU	Reference
N-EVENT-REPORT	M	see 12.3.4.1.1
N-GET	U	see 12.3.4.1.2

12.3.4.1.1 N-EVENT_REPORT

Vivid v203 confirms the N-EVENT-REPORT initiated by the SCP (printer).

12.3.4.1.2 N-GET

Used by Vivid v203 to request the SCP to get a Printer SOP Instance. Table 12.5.2-6 defines the Printer Module attributes.

12.4 PRINT MANAGEMENT IODS

Within an entity of a DICOM Print Management, attributes are grouped into a related set of attributes. A set of related attributes is termed a module. A module facilitates the understanding of the semantics concerning the attributes and how the attributes are related with each other. A module grouping does not infer any encoding of information into datasets.

Table 12.4.1-1, Table 12.4.2-1, Table 12.4.3-1, and Table 12.4.4-1 identify the defined modules within the entities which comprise the DICOM Print Management Service IODs. Modules are identified by Module Name.

See DICOM for a complete definition of the entities, modules and attributes.

12.4.1 Film Session IOD Module

TABLE 12.4.1-1 FILM SESSION IOD MODULES

Module Name	Reference	Module Description
SOP Common Module	12.5.2.1	Contains SOP Common information
Basic Film Session Presentation Module	12.5.2.1	Contains Film Session presentation information
Basic Film Session Relationship Module	12.5.2.2	References to related SOPs

12.4.2 Basic Film Box IOD Module Table

TABLE 12.4.2-1 BASIC FILM BOX IOD MODULES

Module Name	Reference
SOP Common Module	12.5.1.1
Basic Film Box Presentation Module	12.5.2.3
Basic Film Box Relationship Module	12.5.2.2

12.4.3 Basic Image Box IOD Module Table

TABLE 12.4.3-1 BASIC IMAGE BOX IOD MODULES

Module Name	Reference
SOP Common Module	12.5.1.1
Image Box Pixel Presentation Module	12.5.2.5

12.4.4 Printer IOD Module Table

TABLE 12.4.4-1 PRINTER IOD MODULES

Module Name	Reference
SOP Common Module	12.5.1.1
Printer Module	12.5.2.6

12.5 INFORMATION MODULE DEFINITIONS

Please refer to DICOM Standard Part 3 (Information Object Definitions) for a description of each of the entities and modules that comprise the Print Management.

The following modules are included to convey Enumerated Values, Defined Terms, and Optional Attributes supported.

12.5.1 General Modules

12.5.1.1 SOP Common Module

This section defines the attributes that are required for proper functioning and identification of the associated SOP Instances. They do not specify any semantics about the Real-World Object represented by the IOD.

TABLE 12.5.1-1 SOP COMMON MODULE ATTRIBUTES

Attribute Name	Tag	Type	Attribute Description
SOP Class UID	(0008,0016)	1	Varies with Module Instance and DIMSE Service being used. 1.2.840.100011.5.1.1.1 (Film Session) 1.2.840.100011.5.1.1.2 (Film Box) 1.2.840.100011.5.1.1.4 (Image Box)
SOP Instance UID	(0008,0018)	1	Provided by SCP (printer).
Specific Character Set	(0008,0005)	1C	Not used as expanded or replacement character sets not used.
Instance Creation Date	(0008,0012)	3	Not used.
Instance Creation Time	(0008,0013)	3	Not used.
Instance Creator UID	(0008,0014)	3	Not used.

12.5.2 Print Management Modules

For all user configurable tags with no default, no value will be sent if the tag is not configured.

12.5.2.1 Basic Film Session Presentation Module

This section defines the attributes that are common for all films of a film session. The attributes described in table 11.5.2-1 apply when the N-CREATE DIMSE service is used.

TABLE 12.5.2-1 BASIC FILM SESSION PRESENTATION MODULE ATTRIBUTES

Attribute Name	Tag	USAGE (SCU)	Attribute Description
Number of Copies	(2000,0010)	U	Defined Terms used (user configurable): Default is 1. Max is 99.
Print Priority	(2000,0020)	U	Defined Terms used (user configurable): HIGH, MED, LOW. Default is HIGH.
Medium Type	(2000,0030)	U	Defined Terms used (user configurable): PAPER BLUE FILM CLEAR FILM Default is CLEAR FILM.
Film Destination	(2000,0040)	U	Defined Terms used (user configurable): MAGAZINE - default PROCESSOR
Film Session Label	(2000,0050)	U	User configurable. No default.
Memory Allocation	(2000,0060)	U	Not Used
Owner Id	(2100,0160)	U	Not Used

12.5.2.2 Basic Film Session Relationship Module

TABLE 12.5.2-2 BASIC FILM SESSION RELATIONSHIP MODULE ATTRIBUTES

Attribute Name	Tag	USAGE (SCU)	Attribute Description
Referenced Film Box Sequence	(2000,0500)	U	Not used
>Referenced SOP Class UID	(0008,1150)	U	
>Referenced SOP Instance UID	(0008,1155)	U	

12.5.2.3 Basic Film Box Presentation Module

The attributes described in table 11.5.2-3 apply when the N-CREATE DIMSE service is used.

TABLE 12.5.2-3 BASIC FILM BOX PRESENTATION MODULE ATTRIBUTES

Attribute Name	Tag	USAGE (SCU)	Attribute Description
Image Display Format	(2010,0010)	M	Enumerated values used (user configurable): STANDARD\X,Y, where X and Y can take values from 1 to 5. Default is STANDARD\1,1.
Annotation Display Format ID	(2010,0030)	U	Not used.
Film Orientation	(2010,0040)	U	Defined Terms used (user configurable): PORTRAIT - default LANDSCAPE
Film Size ID	(2000,0050)	U	Defined Terms used (user configurable): 8INX10IN - default 10INX12IN 10INX14IN 11INX14IN 14INX14IN 14INX17IN 24CMX24CM 24CMX30CM
Magnification Type	(2010,0060)	U	Defined Terms Used (user configurable): REPLICATE - default BILINEAR CUBIC NONE
Smoothing Type	(2010,0080)	U	Free form text entry field (user configurable) and only sent if Magnification Type is CUBIC. No default
Border Density	(2010,0100)	U	Defined Terms Used (user configurable): BLACK WHITE Default is BLACK.
Empty Image Density	(2010,0110)	U	Defined Terms Used (user configurable): BLACK WHITE Default is WHITE.
Min Density	(2010,0120)	U	User configurable. No default. Max is 999.

Max Density	(2010,0130)	U	User configurable. No default. Max is 999.
Trim	(2010,0140)	U	Enumerated Values Used (user configurable): YES NO Default is NO.
Configuration Information	(2010,0150)	U	User configurable. No default.

12.5.2.4 Basic Film Box Relationship Module

This section defines the attributes that describe the common parameters, which apply for all images on a given sheet of film.

TABLE 12.5.2-4 BASIC FILM BOX RELATIONSHIP MODULE ATTRIBUTES

Attribute Name	Tag	USAGE (SCU)	Attribute Description
Referenced Film Session Sequence	(2010,0500)	M	
>Referenced SOP Class UID	(0008,1150)	M	1.2.840.10008.5.1.1.1
>Referenced SOP Instance UID	(0008,1155)	M	Provided by SCP (printer)
Referenced Image Box Sequence	(2010,0510)	U	Used for the subsequent handling of Image Boxes
>Referenced SOP Class UID	(0008,1150)	U	
>Referenced SOP Instance UID	(0008,1155)	U	
Referenced Basic Annotation Sequence	(2010,0520)	U	Not used
>Referenced SOP Class UID	(0008,1150)	U	
>Referenced SOP Instance UID	(0008,1155)	U	

12.5.2.5 Image Box Pixel Presentation Module

The attributes described in table 11.5.2-5 apply when the DIMSE Service N-SET is used.

The first attributes in the table are used for both grayscale and color printing. The attributes within the sequences are used for each type of printing respectively.

TABLE 12.5.2-5 IMAGE BOX PIXEL PRESENTATION MODULE ATTRIBUTES

Attribute Name	Tag	USAGE (SCU)	Attribute Description
Image Position	(2020,0010)	M	Based on the image display format.
Polarity	(2020,0020)	U	Defined term, NORMAL
Requested Image Size	(2020,0030)	U	Not sent
Basic Grayscale Image Sequence	(2020,0110)	M	
>Samples Per Pixel	(0028,0002)	M	Value = '1'
>Photometric Interpretation	(0028,0004)	M	Defined Term MONOCHROME2 used
>Rows	(0028,0010)	M	Value depends on scanning mode and configuration setup.
>Columns	(0028,0011)	M	Value depends on scanning mode and configuration setup.
>Pixel Aspect Ratio	(0028,0034)	MC	Not used
>Bits Allocated	(0028,0100)	M	Value always = 0008H
>Bits Stored	(0028,0101)	M	Value always = 0008H
>High Bit	(0028,0102)	M	Value always = 0007H
>Pixel Representation	(0028,0103)	M	Defined Value '0' - unsigned integer
>Pixel Data	(7FE0,0010)	M	
Basic Color Image Sequence	(2020,0111)	M	
>Samples Per Pixel	(0028,0002)	M	Value = '3'
>Photometric Interpretation	(0028,0004)	M	Defined Term RGB used
>Rows	(0028,0010)	M	Value depends on scanning mode and configuration setup.
>Columns	(0028,0011)	M	Value depends on scanning mode and configuration setup.
>Pixel Aspect Ratio	(0028,0034)	MC	Not used
>Bits Allocated	(0028,0100)	M	Value always = 0008H
>Bits Stored	(0028,0101)	M	Value always = 0008H
>High Bit	(0028,0102)	M	Value always = 0007H
>Pixel Representation	(0028,0103)	M	Defined Value '0' - unsigned integer
>Pixel Data	(7FE0,0010)	M	
>Planar Configuration	(0028, 0006)	M	0001H, color-by-plane, when Basic Color Image Sequence is set

12.5.2.6 Printer Module

This section defines the attributes that are used to monitor the status of the printer. The attributes described in Table 12.5.2-6 apply when the DIMSE Service N-GET is used.

TABLE 12.5.2-6 PRINTER MODULE ATTRIBUTES

Attribute Name	Tag	USAG E (SCU)	Attribute Description
Printer Status	(2110,0010)	U	Used to check the status of the printer before a print operation is started. If the status is different from NORMAL, the print operation is aborted, a message is displayed and the print files reside in the print buffer.
Printer Status Info	(2110,0020)	U	If return status is "FAILURE" an error message is displayed, and the print files resides in the print buffer.
Printer Name	(2110,0030)	U	Requested, but not used
Manufacturer	(0008,0070)	U	Requested, but not used
Manufacturer Model Name	(0008,1090)	U	Requested, but not used
Device Serial Number	(0018,1000)	U	Requested, but not used
Software Versions	(0018,1020)	U	Requested, but not used
Date Last Calibration	(0018,1200)	U	Requested, but not used
Last Calibration	(0018,1201)	U	Requested, but not used

13. STUDY ROOT QUERY/RETRIEVE INFORMATION MODEL DEFINITION

13.1 INTRODUCTION

This section specifies the use of the DICOM Study Root Query/Retrieve Model used to organize data and against which a Query/Retrieve will be performed. The contents of this section are:

13.2 - Information Model Description

13.3 - Information Model Entity-Relationship Model

13.4 - Information Model Keys

13.2 STUDY ROOT INFORMATION MODEL DESCRIPTION

This section defines the implementation of Study Root Query/Retrieve Information Model.

13.3 STUDY ROOT INFORMATION MODEL ENTITY-RELATIONSHIP MODEL

The Entity-Relationship diagram for the Study Root Information Model schema is shown in Illustration 13.3-1. In this figure, the following diagrammatic convention is established to represent the information organization :

- each entity is represented by a rectangular box
- each relationship is represented by a diamond shaped box.
- the fact that a relationship exists between two entities is depicted by lines connecting the corresponding entity boxes to the relationship boxes.

The relationships are fully defined with the maximum number of possible entities in the relationship shown. In other words, the relationship between Series and Image can have up to n Images per Series.

**ILLUSTRATION 13.3-1
STUDY ROOT QUERY/RETRIEVE INFORMATION MODEL E/R DIAGRAM**

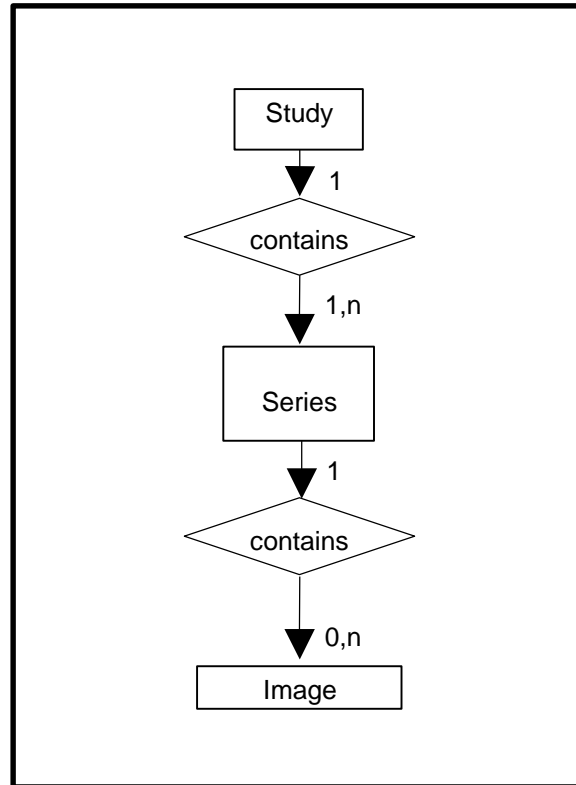

13.3.1 Entity Descriptions

Please refer to DICOM Standard PS 3.4 (Service Class Specifications) for a description of each of the levels contained within the Study Root Query/Retrieve Information Model.

13.3.2 Vivid v203 Mapping of DICOM entities

**TABLE 13.3-1
MAPPING OF DICOM ENTITIES TO VIVID v203 ENTITIES**

DICOM	Vivid v203 Entity
Study	Exam
Series	Exam
Image	Image

13.4 INFORMATION MODEL KEYS

Please refer to DICOM Standard PS 3.4 (Service Class Specifications) for a description of each of the levels contained within the Study Root Query/Retrieve Information Model.

The following Level descriptions are included to specify what data elements are supported and what type of matching can be applied. It should be noted that they are the same ones as defined in the DICOM Standard PS 3.4 (Service Class Specifications).

13.4.1 Supported Matching

Following are the types of matching that can be request by the implementation :

- Single Value matching
- List of UID matching
- Universal Matching
- Wild Card Matching
- Range of date, Range of Time
- Sequence Matching

Fields with “Filtering is supported” in the Matching column can be controlled from the Search screen. This means that the user can filter the downloaded C-FIND result, to view a limited set of the result.

All non-required matching fields can be configured in Config screen to be either enabled, enabled with a constant value or disabled. The constant value will be used as entered by user.

13.4.2 Study Level

This section defines the keys at the Study Level of the Study Root Query/Retrieve Information Model that are supported by this implementation.

**TABLE 13.4-2
STUDY LEVEL ATTRIBUTES FOR THE STUDY ROOT
QUERY/RETRIEVE INFORMATION MODEL**

Attribute Name	Tag	Type	Attribute Description
Study Date	(0008,0020)	R	Matching is supported. Filtering is supported.
Study Time	(0008,0030)	R	Matching is supported.
Accession Number	(0008,0050)	R	Matching is supported. Filtering is supported.
Patient's Name	(0010,0010)	R	Matching is supported. Filtering is supported.
Patient ID	(0010,0020)	R	Matching is supported. Filtering is supported.
Study ID	(0020,0010)	R	Matching is supported. Filtering is supported.
Study Instance UID	(0020,000D)	U	Matching is supported.
Modalities in Study	(0008,0061)	O	Matching is supported.
Referring Physician's Name	(0008,0090)	O	Matching is supported.
Study Description	(0008,1030)	O	Matching is supported.
Procedure Code Sequence	(0008,1032)	O	Matching is supported.
>Include 'Code Sequence Macro'			
Name of Physician(s) Reading Study	(0008,1060)	O	Matching is supported.
Admitting Diagnoses Description	(0008,1080)	O	Matching is supported.
Referenced Study Sequence	(0008,1110)	O	Matching is supported.
>Referenced SOP Class UID	(0008,1150)	O	Matching is supported.
>Referenced SOP Instance UID	(0008,1155)	O	Matching is supported.

Referenced Patient Sequence	(0008,1120)	O	Matching is supported.
>Referenced SOP Class UID	(0008,1150)	O	Matching is supported.
>Referenced SOP Instance UID	(0008,1155)	O	Matching is supported.
Patient's Birth Date	(0010,0030)	O	Matching is supported. Filtering is supported.
Patient's Birth Time	(0010,0032)	O	Matching is supported.
Patient's Sex	(0010,0040)	O	Matching is supported. Filtering is supported.
Other Patient IDs	(0010,1000)	O	Matching is supported. Filtering is supported.
Other Patient Names	(0010,1001)	O	Matching is supported.
Patient's Age	(0010,1010)	O	Matching is supported.
Patient's Size	(0010,1020)	O	Matching is supported.
Patient's Weight	(0010,1030)	O	Matching is supported.
Ethnic Group	(0010,2160)	O	Matching is supported.
Occupation	(0010,2180)	O	Matching is supported.
Additional Patient History	(0010,21B0)	O	Matching is supported.
Patient Comments	(0010,4000)	O	Matching is supported.
Other Study Numbers	(0020,1070)	O	Matching is supported.
Number of Patient Related Studies	(0020,1200)	O	Matching is supported.
Number of Patient Related Series	(0020,1202)	O	Matching is supported.
Number of Patient Related Instances	(0020,1204)	O	Matching is supported.
Number of Study Related Series	(0020,1206)	O	Matching is supported.
Number of Study Related Instances	(0020,1208)	O	Matching is supported.
Interpretation Author	(4008,010C)	O	Matching is supported.

TABLE 13.4-3

Q/R STUDY LEVEL AND LOCATION FOR RETRIEVE ATTRIBUTES

Attribute Name	Tag	Type	Note
Query Retrieve Level	(0008,0052)	-	Value = STUDY

TABLE 13.4-4

Q/R SPECIFIC CHARACTER SET ATTRIBUTES

Attribute Name	Tag	Type	Note
Specific Character Set	(0008,0005)	-	Set to "ISO_IR 100" if extended characters are used in query. ISO_IR 100 is supported in responses.

13.4.3 Series Level

This section defines the keys at the Series Level of the Study Root Query/Retrieve Information Model that are supported by this implementation.

TABLE 13.4-5
SERIES LEVEL ATTRIBUTES FOR THE STUDY ROOT
QUERY/RETRIEVE INFORMATION MODEL

Attribute Name	Tag	Type	Attribute Description
Modality	(0008,0060)	R	Matching is supported.
Series Number	(0020,0011)	R	Matching is supported.
Series Instance UID	(0020,000E)	U	Matching is supported.
Number of Series Related Instances	(0020,1209)	O	Matching is supported.
Series Date	(0008,0021)	O	Matching is supported.
Series Time	(0008,0031)	O	Matching is supported.
Performing Physicians' Name	(0008,1050)	O	Matching is supported.
Protocol Name	(0018,1030)	O	Matching is supported.
Series Description	(0008,103E)	O	Matching is supported.
Operator's Name	(0008,1070)	O	Matching is supported.
Institutional Department Name	(0008,1040)	O	Matching is supported.
Software Versions	(0018,1020)	O	Matching is supported.
Performed Procedure Step Start Date	(0040,0244)	O	Matching is supported.
Performed Procedure Step Start Time	(0040,0245)	O	Matching is supported.
Request Attributes Sequence	(0040,0275)	O	Matching is supported.

TABLE 13.4-6
Q/R SERIES LEVEL AND LOCATION FOR RETRIEVE ATTRIBUTES

Attribute Name	Tag	Type	Note
Query Retrieve Level	(0008,0052)	-	Value = SERIES

TABLE 13.4-7
Q/R SPECIFIC CHARACTER SET ATTRIBUTES

Attribute Name	Tag	Type	Note
Specific Character Set	(0008,0005)	-	Set to "ISO_IR 100" if extended characters are used in query. ISO_IR 100 is supported in responses.

13.4.4 Image Level

This section defines the keys at the Image Level of the Study Root Query/Retrieve Information Model that are supported by this implementation.

TABLE 13.4-8
IMAGE LEVEL ATTRIBUTES FOR THE STUDY ROOT
QUERY/RETRIEVE INFORMATION MODEL

Attribute Name	Tag	Type	Attribute Description
Instance Number	(0020,0013)	R	Matching is supported.

SOP Instance UID	(0008,0018)	U	Matching is supported.
Contrast/Bolus Agent	(0018,0010)	O	Matching is supported.

TABLE 13.4-9

Q/R IMAGE LEVEL AND LOCATION FOR RETRIEVE ATTRIBUTES

Attribute Name	Tag	Type	Note
Query Retrieve Level	(0008,0052)	-	Value = IMAGE

TABLE 13.4-10

Q/R SPECIFIC CHARACTER SET ATTRIBUTES

Attribute Name	Tag	Type	Note
Specific Character Set	(0008,0005)	-	Set to "ISO_IR 100" if extended characters are used in query. ISO_IR 100 is supported in responses.

13.5 PRIVATE DATA DICTIONARY

No private data dictionary is defined.

14. ADULT AND PEDIATRIC ECHOCARDIOGRAPHY PROCEDURE REPORTS

This section describes the contents of the adult and pediatric echocardiography reports.

14.1 USAGE AND EXTENSIONS OF TID 5200 ECHOCARDIOGRAPHY PROCEDURE REPORT

	NL	Rel with Parent	VT	Name	VM	Req Type	Condition	Value Set Constraint
1			CONTAINER	EV (125200, DCM, "Adult Echocardiography Procedure Report")	1	M		Root node
2	>	HAS CONCEPT MOD	INCLUDE	DTID 1204 "Language of Content Item and Descendants"	1	U		
3	>	HAS OBS CONTEXT	INCLUDE	DTID 1001 "Observation Context Concept "	1	M		
4	>	CONTAINS	CONTAINER	DT (55111-9, LN, "Current Procedure Descriptions")	1	U		
5	>>	CONTAINS	CODE	DT (125203, DCM, "Acquisition Protocol")	1-n	M		BCID 12001 "Ultrasound Protocol Types"
6	>	CONTAINS	INCLUDE	DTID 5201 "Echocardiography Patient Characteristics"	1	U		
7	>	CONTAINS	CONTAINER	EV (111028, DCM, "Image Library")	1	U		
8	>>	CONTAINS	IMAGE	No purpose of reference	1-n	M		
9	>	CONTAINS	INCLUDE	DTID 5202 "Echo Section"	1	U		\$SectionSubject = EV (T-32600, SRT, "Left Ventricle") \$MeasType = DCID 12200 "Echocardiography Left Ventricle"
10	>	CONTAINS	INCLUDE	DTID 5202 "Echo Section"	1	U		\$SectionSubject = EV (T-32500, SRT, "Right Ventricle") \$MeasType = DCID 12204

	NL	Rel with Parent	VT	Name	VM	Req Type	Condition	Value Set Constraint
								"Echocardiography Right Ventricle"
11	>	CONTAINS	INCLUDE	DTID 5202 "Echo Section"	1	U		\$SectionSubject = EV (T-32300, SRT, "Left Atrium") \$MeasType = DCID 12205 "Echocardiography Left Atrium"
12	>	CONTAINS	INCLUDE	DTID 5202 "Echo Section"	1	U		\$SectionSubject = EV (T-32200, SRT, "Right Atrium") \$MeasType = DCID 12206 "Echocardiography Right Atrium"
13	>	CONTAINS	INCLUDE	DTID 5202 "Echo Section"	1	U		\$SectionSubject = EV (T-35400, SRT, "Aortic Valve") \$MeasType = DCID 12211 "Echocardiography Aortic Valve"
14	>	CONTAINS	INCLUDE	DTID 5202 "Echo Section"	1	U		\$SectionSubject = EV (T-35300, SRT, "Mitral Valve") \$MeasType = DCID 12207 "Echocardiography Mitral Valve"
15	>	CONTAINS	INCLUDE	DTID 5202 "Echo Section"	1	U		\$SectionSubject = EV (T-35200, SRT, "Pulmonic Valve") \$MeasType = DCID 12209 "Echocardiography Pulmonic Valve"
16	>	CONTAINS	INCLUDE	DTID 5202 "Echo Section"	1	U		\$SectionSubject = EV (T-35100, SRT, "Tricuspid Valve") \$MeasType = DCID 12208 "Echocardiography Tricuspid Valve"
17	>	CONTAINS	INCLUDE	DTID 5202 "Echo Section"	1	U		\$SectionSubject = EV (T-42000, SRT, "Aorta") \$MeasType = DCID 12212 "Echocardiography Aorta"
18	>	CONTAINS	INCLUDE	DTID 5202 "Echo Section"	1	U		\$SectionSubject = EV (T-44000, SRT, "Pulmonary

	NL	Rel with Parent	VT	Name	VM	Req Type	Condition	Value Set Constraint
								artery") \$MeasType = DCID 12210 "Echocardiography Pulmonary Artery"
19	>	CONTAINS	INCLUDE	DTID 5202 "Echo Section"	1	U		\$SectionSubject = EV (T-48600, SRT, "Vena Cava") \$MeasType = DCID 12215 "Echocardiography Vena Cavae"
20	>	CONTAINS	INCLUDE	DTID 5202 "Echo Section"	1	U		\$SectionSubject = EV (T-48581, SRT, "Pulmonary Venous Structure") \$MeasType = DCID 12214 "Echocardiography Pulmonary Veins"
21	>	CONTAINS	INCLUDE	DTID 5202 "Echo Section"	1	U		\$SectionSubject = EV (T-39050, SRT, "Pericardial cavity") \$MeasType = DCID 12250 "Cardiac Ultrasound Common Linear Measurements"
22	>	CONTAINS	INCLUDE	DTID 5202 "Echo Section"	1	U		\$SectionSubject = EV (P5-30031, SRT, "Cardiac Shunt Study") \$MeasType = DCID 12217 "Echocardiography Cardiac Shunt"
23	>	CONTAINS	INCLUDE	DTID 5202 "Echo Section"	1	U		\$SectionSubject = EV (D4-30000, SRT, "Congenital Anomaly of Cardiovascular System") \$MeasType = DCID 12218 "Echocardiography Congenital"
24	>	CONTAINS	INCLUDE	DTID 5202 "Echo Section"	1	U		\$SectionSubject = EV (T-42102, SRT, "Aortic Sinotubular Junction")
25	>	CONTAINS	INCLUDE	DTID 5202 "Echo Section"	1	U		\$SectionSubject = EV (T-42200, SRT, "Sinus of Valsalva")

	NL	Rel with Parent	VT	Name	VM	Req Type	Condition	Value Set Constraint
26	>	CONTAINS	INCLUDE	DTID 5202 "Echo Section"	1	U		\$SectionSubject = EV (T-43000, SRT, "Coronary Artery")
27	>	CONTAINS	INCLUDE	DTID 5202 "Echo Section"	1	U		\$SectionSubject = EV (D4-31012, SRT, "Patent Foramen Ovale")
28	>	CONTAINS	INCLUDE	DTID 5202 "Echo Section"	1	U		\$SectionSubject = EV (D4-32012, SRT, "Sinus of Valsalva")
29	>	CONTAINS	INCLUDE	DTID 5202 "Echo Section"	1	U		\$SectionSubject = EV (GEU-106-0056, 99GEMS, "Mitral Valve (prosthetics)")
30	>	CONTAINS	INCLUDE	DTID 5202 "Echo Section"	1	U		\$SectionSubject = EV (GEU-106-0057, 99GEMS, "Aortic Valve (prosthetics)")

14.2 USAGE AND EXTENSION OF TID 5220 PEDIATRIC, FETAL AND CONGENITAL CARDIAC ULTRASOUND REPORTS

	NL	Relation with Parent	Value Type	Concept Name	VM	Req Type	Condition	Value Set Constraint
1			CONTAINER	DCID 12245 "Cardiac Ultrasound Report Titles"	1	M		Root node
	>	HAS CONCEPT MODE	INCLUDE	DTID 1204 "Language of Content Item and Descendants"	1	M		
	>	HAS OBS CONTEXT	INCLUDE	DTID 1001 "Observation Context"	1	M		

>	CONTAINS	CONTAINER	EV (18785-6, LN, "Indications for Procedure")	1	U		
>>	CONTAINS	CODE	EV (121071, DCM, "Finding")	1-n	U		DCID 12246 "Cardiac Ultrasound Indication for Study"
>>	CONTAINS	TEXT	EV (121071, DCM, "Finding")	1	U		
>	CONTAINS	INCLUDE	DTID 3802 "Cardiovascular Patient History"	1	U		
>	CONTAINS	INCLUDE	DTID 3602 "Cardiovascular Patient Characteristics"	1	U		
>	CONTAINS	INCLUDE	DTID 5225 "Cardiac Ultrasound Fetal Characteristics"	1-n	U		No more than one inclusion per fetus
>	CONTAINS	INCLUDE	DTID 5226 "Cardiac Ultrasound Summary Section"	1	U		
>	CONTAINS	INCLUDE	DTID 5227 "Cardiac Ultrasound Fetal Summary Section"	1-n	U		No more than one inclusion per fetus
>	CONTAINS	CONTAINER	EV (111028, DCM, "Image Library")	1	U		
>>	CONTAINS	IMAGE	No purpose of reference	1	U		
>	CONTAINS	INCLUDE	DTID 5221 "Cardiac Ultrasound Pediatric Echo Measurement Section"	1	U		
>	CONTAINS	INCLUDE	DTID 5228 "Cardiac Ultrasound Fetal Measurement Section"	1-n	UC	For Fetal Report Only	No more than one inclusion per fetus

14.3 TID 3602 CARDIOVASCULAR PATIENT CHARACTERISTICS

NL	Relation with Parent	Value Type	Concept Name	VM	Req Type	Condition	Value Set Constraint
----	----------------------	------------	--------------	----	----------	-----------	----------------------

1			CONTAINER	EV (121118, DCM, "Patient Characteristics")	1	M		
	>	CONTAINS	NUM	EV (121033, DCM, "Subject Age")	1	M		Units = DCID (7456) Units of Measure for Age
	>	CONTAINS	CODE	EV (121032, DCM, "Subject Sex")	1	M		DCID (7455) Sex
	>	CONTAINS	NUM	EV (8302-2, LN, "Patient Height")	1	M		UNITS = EV (cm, UCUM, "cm")
	>	CONTAINS	NUM	EV (29463-7, LN, "Patient Weight")	1	M		UNITS = EV (kg, UCUM, "kg")
	>	CONTAINS	NUM	EV (122221, DCM, "Thorax Diameter, sagittal")	1	U		UNITS = EV (cm, UCUM, "cm")
	>	CONTAINS	NUM	EV (8277-6., LN, "Body Surface Area")	1	MC	IF BSA used for indexed measurements in SOP Instance	UNITS = EV (kg/m2, UCUM, "kg/m2")
	>>	INFERRED FROM	CODE	EV (9278-4, LN, "Body Surface Area Formula")	1	U		BCID 3663 "Body Surface Area Equations"
	>	CONTAINS	NUM	EV (F-01860, SRT, "Body Mass Index")	1	U		UNITS = EV (kg/m2, UCUM, "kg/m2")
	>>>	INFERRED FROM	CODE	EV (121420, DCM, "Equation")	1	U		DT (122265, DCM, "BMI = Wt/Ht^2")
	>	CONTAINS	NUM	EV (8867-4, LN, "Heart Rate")	1	U		UNITS = EV ({H.B.}/min, UCUM, "BPM")
	>	CONTAINS	NUM	EV (F-008EC, SRT, "Systolic Blood Pressure")	1	U		UNITS = DCID 3500 "Pressure Units"
	>	CONTAINS	NUM	EV (F-008ED, SRT, "Diastolic Blood Pressure")	1	U		UNITS = DCID 3500 "Pressure Units"
	>	CONTAINS	CODE	DT (8884-9, LN, "Cardiac Rhythm")	1	U		BCID 3415 "Cardiac Rhythms"
	>	CONTAINS	NUM	EV (F-03D8C, SRT, "Chest Circumference")	1	U		UNITS = EV (cm, UCUM, "cm")

>	CONTAINS	TEXT	EV (F-009E4, SRT, "Breast size")	1	U		Bra size as text string
>	CONTAINS	CODE	EV (121071, DCM, "Finding")	1	U		DCID 3202 "Chest Pain"
>	CONTAINS	CODE	EV (F-04FCC, SRT, "Functional capacity")	1	U		DCID 3719 "Canadian Clinical Classification"
>	CONTAINS	CODE	EV (F-04FCC, SRT, "Functional capacity")	1	U		DCID 3736 "NYHA Classification"
>	CONTAINS	CODE	EV (121071, DCM, "Finding")	1-n	U		
>	CONTAINS	TEXT	EV (121110, DCM, "Patient Presentation")	1	U		

14.4 MEASUREMENTS MAPPING TO STRUCTURED REPORTS

This table maps the product’s internal parameter ids (each parameter id has a corresponding alias which is the parameter name displayed in the product’s user interface) and in some cases the mode to:

(Anatomy) Section, Base Measurement and Modifiers in Echocardiography Procedure Report (TID 5200) SR. The parameters are grouped by Section.

Note: If “Use older SR version” is enabled (see 2.6, 3.6 and 7) the corresponding mapping table present in the DICOM Conformance Statement of the selected version should be used.

Section Left Ventricle

GEU Parameter ID (and corresponding alias)	Base Measurement Concept Name	Concept or Acquisition Context Modifier
GPSL(4D) Alias: GPSL	(GEU-106-0001, 99GEMS, "Global Peak Longitudinal Strain")	(G-0373, SRT, "Image Mode") = (125231, DCM, "3D mode")
LVd Mass(4D) Alias: EDMass	(18087-7, LN, "Left Ventricle Mass")	(G-0373, SRT, "Image Mode") = (125231, DCM, "3D mode") (R-4089A, SRT, "Cardiac Cycle Point") = (F-32010, SRT, "Diastole") (G-C036, SRT, "Measurement Method") = (GEU-106-0023, 99GEMS, "4D Auto Left Ventricle Quantification")

<p>LVs Mass(4D) Alias: ESMass</p>	<p>(18087-7, LN, "Left Ventricle Mass")</p>	<p>(G-0373, SRT, "Image Mode") = (125231, DCM, "3D mode") (R-4089A, SRT, "Cardiac Cycle Point") = (F-32020, SRT, "Systole") (G-C036, SRT, "Measurement Method") = (GEU-106-0023, 99GEMS, "4D Auto Left Ventricle Quantification")</p>
<p>Auto2DEF/HR_2Ch_Q Alias: HR_2Ch_Q</p>	<p>(8867-4, LN, "Heart rate")</p>	<p>(111031, DCM, "Image View") = (G-A19B, SRT, "Apical two chamber") (G-C036, SRT, "Measurement Method") = (GEU-106-0019, 99GEMS, "2D Auto EF")</p>
<p>Auto2DEF/LVVED_2Ch_Q Alias: LVVED_2Ch_Q</p>	<p>(18026-5, LN, "Left Ventricular End Diastolic Volume")</p>	<p>(111031, DCM, "Image View") = (G-A19B, SRT, "Apical two chamber") (G-C036, SRT, "Measurement Method") = (GEU-106-0019, 99GEMS, "2D Auto EF")</p>
<p>Auto2DEF/LVVES_2Ch_Q Alias: LVVES_2Ch_Q</p>	<p>(18148-7, LN, "Left Ventricular End Systolic Volume")</p>	<p>(111031, DCM, "Image View") = (G-A19B, SRT, "Apical two chamber") (G-C036, SRT, "Measurement Method") = (GEU-106-0019, 99GEMS, "2D Auto EF")</p>
<p>Auto2DEF/LVEF_2Ch_Q Alias: LVEF_2Ch_Q</p>	<p>(18043-0, LN, "Left Ventricular Ejection Fraction")</p>	<p>(111031, DCM, "Image View") = (G-A19B, SRT, "Apical two chamber") (G-C036, SRT, "Measurement Method") = (GEU-106-0019, 99GEMS, "2D Auto EF")</p>
<p>Auto2DEF/LVSV_2Ch_Q Alias: LVSV_2Ch_Q</p>	<p>(F-32120, SRT, "Stroke Volume")</p>	<p>(111031, DCM, "Image View") = (G-A19B, SRT, "Apical two chamber") (G-C036, SRT, "Measurement Method") = (GEU-106-0019, 99GEMS, "2D Auto EF")</p>
<p>Auto2DEF/LVCO_2Ch_Q Alias: LVCO_2Ch_Q</p>	<p>(F-32100, SRT, "Cardiac Output")</p>	<p>(111031, DCM, "Image View") = (G-A19B, SRT, "Apical two chamber") (G-C036, SRT, "Measurement Method") = (GEU-106-0019, 99GEMS, "2D Auto EF")</p>

		99GEMS, "2D Auto EF")
Auto2DEF/LVLs_2Ch_Q Alias: LVLs_2Ch_Q	(18073-7, LN, "Left Ventricular Major Axis Systolic Dimension, 2-chamber view")	(G-C036, SRT, "Measurement Method") = (GEU-106-0019, 99GEMS, "2D Auto EF")
Auto2DEF/LVLd_2Ch_Q Alias: LVLd_2Ch_Q	(18072-9, LN, "Left Ventricular Major Axis Diastolic Dimension, 2-chamber view")	(G-C036, SRT, "Measurement Method") = (GEU-106-0019, 99GEMS, "2D Auto EF")
Auto2DEF/HR_4Ch_Q Alias: HR_4Ch_Q	(8867-4, LN, "Heart rate")	(111031, DCM, "Image View") = (G-A19C, SRT, "Apical four chamber") (G-C036, SRT, "Measurement Method") = (GEU-106-0019, 99GEMS, "2D Auto EF")
Auto2DEF/LVVED_4Ch_Q Alias: LVVED_4Ch_Q	(18026-5, LN, "Left Ventricular End Diastolic Volume")	(111031, DCM, "Image View") = (G-A19C, SRT, "Apical four chamber") (G-C036, SRT, "Measurement Method") = (GEU-106-0019, 99GEMS, "2D Auto EF")
Auto2DEF/LVVES_4Ch_Q Alias: LVVES_4Ch_Q	(18148-7, LN, "Left Ventricular End Systolic Volume")	(111031, DCM, "Image View") = (G-A19C, SRT, "Apical four chamber") (G-C036, SRT, "Measurement Method") = (GEU-106-0019, 99GEMS, "2D Auto EF")
Auto2DEF/LVEF_4Ch_Q Alias: LVEF_4Ch_Q	(18043-0, LN, "Left Ventricular Ejection Fraction")	(111031, DCM, "Image View") = (G-A19C, SRT, "Apical four chamber") (G-C036, SRT, "Measurement Method") = (GEU-106-0019, 99GEMS, "2D Auto EF")
Auto2DEF/LVSV_4Ch_Q Alias: LVSV_4Ch_Q	(F-32120, SRT, "Stroke Volume")	(111031, DCM, "Image View") = (G-A19C, SRT, "Apical four chamber") (G-C036, SRT, "Measurement Method") = (GEU-106-0019, 99GEMS, "2D Auto EF")
Auto2DEF/LVCO_4Ch_Q Alias: LVCO_4Ch_Q	(F-32100, SRT, "Cardiac Output")	(111031, DCM, "Image View") = (G-A19C, SRT, "Apical four chamber")

		(G-C036, SRT, "Measurement Method") = (GEU-106-0019, 99GEMS, "2D Auto EF")
Auto2DEF/LVLs_4Ch_Q Alias: LVLs_4Ch_Q	(18075-2, LN, "Left Ventricular Major Axis Systolic Dimension, 4-chamber view")	(G-C036, SRT, "Measurement Method") = (GEU-106-0019, 99GEMS, "2D Auto EF")
Auto2DEF/LVLd_4Ch_Q Alias: LVLd_4Ch_Q	(18074-5, LN, "Left Ventricular Major Axis Diastolic Dimension, 4-chamber view")	(G-C036, SRT, "Measurement Method") = (GEU-106-0019, 99GEMS, "2D Auto EF")
Auto2DEF/LVVED_BiP_Q Alias: LVVED_BiP_Q	(18026-5, LN, "Left Ventricular End Diastolic Volume")	(G-C036, SRT, "Measurement Method") = (GEU-106-0019, 99GEMS, "2D Auto EF")
Auto2DEF/LVVES_BiP_Q Alias: LVVES_BiP_Q	(18148-7, LN, "Left Ventricular End Systolic Volume")	(G-C036, SRT, "Measurement Method") = (GEU-106-0019, 99GEMS, "2D Auto EF")
Auto2DEF/LVEF_BiP_Q Alias: LVEF_BiP_Q	(18043-0, LN, "Left Ventricular Ejection Fraction")	(G-C036, SRT, "Measurement Method") = (GEU-106-0019, 99GEMS, "2D Auto EF")
Auto2DEF/LVSV_BiP_Q Alias: LVSV_BiP_Q	(F-32120, SRT, "Stroke Volume")	(G-C036, SRT, "Measurement Method") = (GEU-106-0019, 99GEMS, "2D Auto EF")
Auto2DEF/LVCO_BiP_Q Alias: LVCO_BiP_Q	(F-32100, SRT, "Cardiac Output")	(G-C036, SRT, "Measurement Method") = (GEU-106-0019, 99GEMS, "2D Auto EF")
TomTec/LVFunction/EDV Alias: LVEDV(TomTec)	(18026-5, LN, "Left Ventricular End Diastolic Volume")	(G-C036, SRT, "Measurement Method") = (GEU-106-0021, 99GEMS, "4D Left Ventricle Volume")
TomTec/LVFunction/ESV Alias: LVESV(TomTec)	(18148-7, LN, "Left Ventricular End Systolic Volume")	(G-C036, SRT, "Measurement Method") = (GEU-106-0021, 99GEMS, "4D Left Ventricle Volume")
TomTec/LVFunction/SV Alias: SV(TomTec)	(F-32120, SRT, "Stroke Volume")	(G-C036, SRT, "Measurement Method") = (GEU-106-0021, 99GEMS, "4D Left Ventricle Volume")

<p>TomTec/LVFunction/EF Alias: EF(TomTec)</p>	<p>(18043-0, LN, "Left Ventricular Ejection Fraction")</p>	<p>(G-C036, SRT, "Measurement Method") = (GEU-106-0021, 99GEMS, "4D Left Ventricle Volume")</p>
<p>TomTec/LVFunction/SDI16 Alias: SDI16(TomTec)</p>	<p>(GEU-106-0016, 99GEMS, "Systolic Dyssynchrony Index")</p>	<p>(G-C036, SRT, "Measurement Method") = (GEU-106-0021, 99GEMS, "4D Left Ventricle Volume")</p>
<p>LVLad(apical) Alias: TEa(d)</p>	<p>(G-0377, SRT, "Left Ventricle Semi-major Axis Diastolic Dimension")</p>	
<p>LVLas(apical) Alias: LVLas Apical</p>	<p>(GEU-106-0067, 99GEMS, "Left ventricle Semi-major axis between apex and cavity minor radius")</p>	<p>(G-0373, SRT, "Image Mode") = (G-03A2, SRT, "2D mode") (R-4089A, SRT, "Cardiac Cycle Point") = (F-32020, SRT, "Systole") (G-C036, SRT, "Measurement Method") = (125222, DCM, "Left Ventricle Mass Truncated Ellipse")</p>
<p>LVLds(apical) Alias: LVLds Apical</p>	<p>(GEU-106-0068, 99GEMS, "Left ventricle truncated Semi-major axis between cavity minor radius and mitral valve")</p>	<p>(G-0373, SRT, "Image Mode") = (G-03A2, SRT, "2D mode") (R-4089A, SRT, "Cardiac Cycle Point") = (F-32020, SRT, "Systole") (G-C036, SRT, "Measurement Method") = (125222, DCM, "Left Ventricle Mass Truncated Ellipse")</p>
<p>LVLdd(apical) Alias: Ted(d)</p>	<p>(G-0378, SRT, "Left Ventricle Truncated Semi-major Axis Diastolic Dimension")</p>	
<p>LVd Mass(TE) Alias: LVd Mass TE</p>	<p>(18087-7, LN, "Left Ventricle Mass")</p>	<p>(R-4089A, SRT, "Cardiac Cycle Point") = (F-32010, SRT, "Diastole") (G-C036, SRT, "Measurement Method") = (125222, DCM, "Left Ventricle Mass Truncated Ellipse")</p>

<p>LVd Mass Index(TE) Alias: LVd Mass Ind TE</p>	<p>(GEU-106-0028, 99GEMS, "Left Ventricle Mass Index")</p>	<p>(R-4089A, SRT, "Cardiac Cycle Point") = (F-32010, SRT, "Diastole") (G-C036, SRT, "Measurement Method") = (125222, DCM, "Left Ventricle Mass Truncated Ellipse")</p>
<p>LVs Mass(TE) Alias: LVs Mass TE</p>	<p>(18087-7, LN, "Left Ventricle Mass")</p>	<p>(R-4089A, SRT, "Cardiac Cycle Point") = (F-32020, SRT, "Systole") (G-C036, SRT, "Measurement Method") = (125222, DCM, "Left Ventricle Mass Truncated Ellipse")</p>
<p>LVLd(avg) Alias: LVLd(avg)</p>	<p>(18077-8, LN, "Left Ventricle diastolic major axis")</p>	<p>(G-C036, SRT, "Measurement Method") = (GEU-106-0017, 99GEMS, "Triplane")</p>
<p>LVEDV(Geom) Alias: LVEDV(Geom)</p>	<p>(18026-5, LN, "Left Ventricular End Diastolic Volume")</p>	<p>(G-C036, SRT, "Measurement Method") = (GEU-106-0017, 99GEMS, "Triplane")</p>
<p>LVLs(avg) Alias: LVLs(avg)</p>	<p>(18076-0, LN, "Left Ventricle systolic major axis")</p>	<p>(G-C036, SRT, "Measurement Method") = (GEU-106-0017, 99GEMS, "Triplane")</p>
<p>LVCd(avg) Alias: LVLs Avg</p>	<p>(GEU-106-0101, 99GEMS, "Left Ventricle Circumference by triplane method")</p>	<p>(R-4089A, SRT, "Cardiac Cycle Point") = (F-32010, SRT, "Diastole") (G-C036, SRT, "Measurement Method") = (GEU-106-0017, 99GEMS, "Triplane")</p>
<p>LVCs(avg) Alias: LVCs Avg</p>	<p>(GEU-106-0101, 99GEMS, "Left Ventricle Circumference by triplane method")</p>	<p>(R-4089A, SRT, "Cardiac Cycle Point") = (F-32020, SRT, "Systole") (G-C036, SRT, "Measurement Method") = (GEU-106-0017, 99GEMS, "Triplane")</p>
<p>LVESV(Geom) Alias: LVESV(Geom)</p>	<p>(18148-7, LN, "Left Ventricular End Systolic Volume")</p>	<p>(G-C036, SRT, "Measurement Method") = (GEU-106-0017, 99GEMS, "Triplane")</p>
<p>EF(Geom)</p>	<p>(18043-0, LN, "Left Ventricular Ejection")</p>	<p>(G-C036, SRT, "Measurement Method") = (GEU-106-0017,</p>

Alias: EF(Geom)	Fraction")	99GEMS, "Triplane")
SV(Geom) Alias: SV(Geom)	(F-32120, SRT, "Stroke Volume")	(G-C036, SRT, "Measurement Method") = (GEU-106-0017, 99GEMS, "Triplane")
CO(Geom) Alias: CO(Geom)	(F-32100, SRT, "Cardiac Output")	(G-C036, SRT, "Measurement Method") = (GEU-106-0017, 99GEMS, "Triplane")
TSI/BS PeakVel Alias: BS PeakVel	(11726-7, LN, "Peak Velocity")	(G-C0E3, SRT, "Finding Site") = (R-10076, SRT, "left ventricle basal inferoseptal segment") (G-0373, SRT, "Image Mode") = (GEU-106-0024, 99GEMS, "Tissue Doppler Imaging") (G-C036, SRT, "Measurement Method") = (GEU-106-0020, 99GEMS, "Tissue Synchronization Imaging")
TSI/BS TimeToPeak Alias: BS TimeToPeak	(GEU-106-0006, 99GEMS, "Time To Peak")	(G-C0E3, SRT, "Finding Site") = (R-10076, SRT, "left ventricle basal inferoseptal segment") (G-0373, SRT, "Image Mode") = (GEU-106-0024, 99GEMS, "Tissue Doppler Imaging") (G-C036, SRT, "Measurement Method") = (GEU-106-0020, 99GEMS, "Tissue Synchronization Imaging")
TSI/MS PeakVel Alias: MS PeakVel	(11726-7, LN, "Peak Velocity")	(G-C0E3, SRT, "Finding Site") = (R-10078, SRT, "left ventricle mid inferoseptal segment") (G-0373, SRT, "Image Mode") = (GEU-106-0024, 99GEMS, "Tissue Doppler Imaging") (G-C036, SRT, "Measurement Method") = (GEU-106-0020, 99GEMS, "Tissue Synchronization Imaging")
TSI/MS TimeToPeak Alias: MS TimeToPeak	(GEU-106-0006, 99GEMS, "Time To Peak")	(G-C0E3, SRT, "Finding Site") = (R-10078, SRT, "left ventricle mid inferoseptal segment") (G-0373, SRT, "Image Mode") = (GEU-106-0024, 99GEMS, "Tissue Doppler Imaging") (G-C036, SRT, "Measurement Method") = (GEU-106-0020,

		99GEMS, "Tissue Synchronization Imaging")
<p>TSI/ML PeakVel Alias: ML PeakVel</p>	<p>(11726-7, LN, "Peak Velocity")</p>	<p>(G-C0E3, SRT, "Finding Site") = (R-1007C, SRT, "left ventricle mid anterolateral segment") (G-0373, SRT, "Image Mode") = (GEU-106-0024, 99GEMS, "Tissue Doppler Imaging") (G-C036, SRT, "Measurement Method") = (GEU-106-0020, 99GEMS, "Tissue Synchronization Imaging")</p>
<p>TSI/ML TimeToPeak Alias: ML TimeToPeak</p>	<p>(GEU-106-0006, 99GEMS, "Time To Peak")</p>	<p>(G-C0E3, SRT, "Finding Site") = (R-1007C, SRT, "left ventricle mid anterolateral segment") (G-0373, SRT, "Image Mode") = (GEU-106-0024, 99GEMS, "Tissue Doppler Imaging") (G-C036, SRT, "Measurement Method") = (GEU-106-0020, 99GEMS, "Tissue Synchronization Imaging")</p>
<p>TSI/BL PeakVel Alias: BL PeakVel</p>	<p>(11726-7, LN, "Peak Velocity")</p>	<p>(G-C0E3, SRT, "Finding Site") = (R-1007A, SRT, "left ventricle basal anterolateral segment") (G-0373, SRT, "Image Mode") = (GEU-106-0024, 99GEMS, "Tissue Doppler Imaging") (G-C036, SRT, "Measurement Method") = (GEU-106-0020, 99GEMS, "Tissue Synchronization Imaging")</p>
<p>TSI/BL TimeToPeak Alias: BL TimeToPeak</p>	<p>(GEU-106-0006, 99GEMS, "Time To Peak")</p>	<p>(G-C0E3, SRT, "Finding Site") = (R-1007A, SRT, "left ventricle basal anterolateral segment") (G-0373, SRT, "Image Mode") = (GEU-106-0024, 99GEMS, "Tissue Doppler Imaging") (G-C036, SRT, "Measurement Method") = (GEU-106-0020, 99GEMS, "Tissue Synchronization Imaging")</p>
<p>TSI/BI PeakVel Alias: BI PeakVel</p>	<p>(11726-7, LN, "Peak Velocity")</p>	<p>(G-C0E3, SRT, "Finding Site") = (T-32615, SRT, "left ventricle basal inferior segment") (G-0373, SRT, "Image Mode") = (GEU-106-0024, 99GEMS,</p>

		<p>“Tissue Doppler Imaging”) (G-C036, SRT, “Measurement Method”) = (GEU-106-0020, 99GEMS, “Tissue Synchronization Imaging”)</p>
<p>TSI/BI TimeToPeak Alias: BI TimeToPeak</p>	<p>(GEU-106-0006, 99GEMS, “Time To Peak”)</p>	<p>(G-C0E3, SRT, “Finding Site”) = (T-32615, SRT, “left ventricle basal inferior segment”) (G-0373, SRT, “Image Mode”) = (GEU-106-0024, 99GEMS, “Tissue Doppler Imaging”) (G-C036, SRT, “Measurement Method”) = (GEU-106-0020, 99GEMS, “Tissue Synchronization Imaging”)</p>
<p>TSI/MI PeakVel Alias: MI PeakVel</p>	<p>(11726-7, LN, “Peak Velocity”)</p>	<p>(G-C0E3, SRT, “Finding Site”) = (T-32616, SRT, “left ventricle mid inferior segment”) (G-0373, SRT, “Image Mode”) = (GEU-106-0024, 99GEMS, “Tissue Doppler Imaging”) (G-C036, SRT, “Measurement Method”) = (GEU-106-0020, 99GEMS, “Tissue Synchronization Imaging”)</p>
<p>TSI/MI TimeToPeak Alias: MI TimeToPeak</p>	<p>(GEU-106-0006, 99GEMS, “Time To Peak”)</p>	<p>(G-C0E3, SRT, “Finding Site”) = (T-32616, SRT, “left ventricle mid inferior segment”) (G-0373, SRT, “Image Mode”) = (GEU-106-0024, 99GEMS, “Tissue Doppler Imaging”) (G-C036, SRT, “Measurement Method”) = (GEU-106-0020, 99GEMS, “Tissue Synchronization Imaging”)</p>
<p>TSI/MA PeakVel Alias: MA PeakVel</p>	<p>(11726-7, LN, “Peak Velocity”)</p>	<p>(G-C0E3, SRT, “Finding Site”) = (T-32617, SRT, “left ventricle mid anterior segment”) (G-0373, SRT, “Image Mode”) = (GEU-106-0024, 99GEMS, “Tissue Doppler Imaging”) (G-C036, SRT, “Measurement Method”) = (GEU-106-0020, 99GEMS, “Tissue Synchronization Imaging”)</p>
<p>TSI/MA TimeToPeak</p>	<p>(GEU-106-0006, 99GEMS,</p>	<p>(G-C0E3, SRT, “Finding Site”) = (T-32617, SRT, “left ventricle mid</p>

<p>Alias: MA TimeToPeak</p>	<p>“Time To Peak”)</p>	<p>anterior segment”) (G-0373, SRT, “Image Mode”) = (GEU-106-0024, 99GEMS, “Tissue Doppler Imaging”) (G-C036, SRT, “Measurement Method”) = (GEU-106-0020, 99GEMS, “Tissue Synchronization Imaging”)</p>
<p>TSI/BA PeakVel Alias: BA PeakVel</p>	<p>(11726-7, LN, “Peak Velocity”)</p>	<p>(G-C0E3, SRT, “Finding Site”) = (T-32619, SRT, “left ventricle basal anterior segment”) (G-0373, SRT, “Image Mode”) = (GEU-106-0024, 99GEMS, “Tissue Doppler Imaging”) (G-C036, SRT, “Measurement Method”) = (GEU-106-0020, 99GEMS, “Tissue Synchronization Imaging”)</p>
<p>TSI/BA TimeToPeak Alias: BA TimeToPeak</p>	<p>(GEU-106-0006, 99GEMS, “Time To Peak”)</p>	<p>(G-C0E3, SRT, “Finding Site”) = (T-32619, SRT, “left ventricle basal anterior segment”) (G-0373, SRT, “Image Mode”) = (GEU-106-0024, 99GEMS, “Tissue Doppler Imaging”) (G-C036, SRT, “Measurement Method”) = (GEU-106-0020, 99GEMS, “Tissue Synchronization Imaging”)</p>
<p>TSI/BP PeakVel Alias: BP PeakVel</p>	<p>(11726-7, LN, “Peak Velocity”)</p>	<p>(G-C0E3, SRT, “Finding Site”) = (R-10079, SRT, “left ventricle basal inferolateral segment”) (G-0373, SRT, “Image Mode”) = (GEU-106-0024, 99GEMS, “Tissue Doppler Imaging”) (G-C036, SRT, “Measurement Method”) = (GEU-106-0020, 99GEMS, “Tissue Synchronization Imaging”)</p>
<p>TSI/BP TimeToPeak Alias: BP TimeToPeak</p>	<p>(GEU-106-0006, 99GEMS, “Time To Peak”)</p>	<p>(G-C0E3, SRT, “Finding Site”) = (R-10079, SRT, “left ventricle basal inferolateral segment”) (G-0373, SRT, “Image Mode”) = (GEU-106-0024, 99GEMS, “Tissue Doppler Imaging”) (G-C036, SRT, “Measurement Method”) = (GEU-106-0020, 99GEMS, “Tissue</p>

		Synchronization Imaging”)
<p>TSI/MP PeakVel Alias: MP PeakVel</p>	<p>(11726-7, LN, “Peak Velocity”)</p>	<p>(G-C0E3, SRT, “Finding Site”) = (R-1007B, SRT, “left ventricle mid inferolateral segment”) = (G-0373, SRT, “Image Mode”) = (GEU-106-0024, 99GEMS, “Tissue Doppler Imaging”) (G-C036, SRT, “Measurement Method”) = (GEU-106-0020, 99GEMS, “Tissue Synchronization Imaging”)</p>
<p>TSI/MP TimeToPeak Alias: MP TimeToPeak</p>	<p>(GEU-106-0006, 99GEMS, “Time To Peak”)</p>	<p>(G-C0E3, SRT, “Finding Site”) = (R-1007B, SRT, “left ventricle mid inferolateral segment”) = (G-0373, SRT, “Image Mode”) = (GEU-106-0024, 99GEMS, “Tissue Doppler Imaging”) (G-C036, SRT, “Measurement Method”) = (GEU-106-0020, 99GEMS, “Tissue Synchronization Imaging”)</p>
<p>TSI/MAS PeakVel Alias: MAS PeakVel</p>	<p>(11726-7, LN, “Peak Velocity”)</p>	<p>(G-C0E3, SRT, “Finding Site”) = (R-10077, SRT, “left ventricle mid anteroseptal segment”) = (G-0373, SRT, “Image Mode”) = (GEU-106-0024, 99GEMS, “Tissue Doppler Imaging”) (G-C036, SRT, “Measurement Method”) = (GEU-106-0020, 99GEMS, “Tissue Synchronization Imaging”)</p>
<p>TSI/MAS TimeToPeak Alias: MAS TimeToPeak</p>	<p>(GEU-106-0006, 99GEMS, “Time To Peak”)</p>	<p>(G-C0E3, SRT, “Finding Site”) = (R-10077, SRT, “left ventricle mid anteroseptal segment”) = (G-0373, SRT, “Image Mode”) = (GEU-106-0024, 99GEMS, “Tissue Doppler Imaging”) (G-C036, SRT, “Measurement Method”) = (GEU-106-0020, 99GEMS, “Tissue Synchronization Imaging”)</p>
<p>TSI/BAS PeakVel Alias: BAS PeakVel</p>	<p>(11726-7, LN, “Peak Velocity”)</p>	<p>(G-C0E3, SRT, “Finding Site”) = (R-10075, SRT, “left ventricle basal anteroseptal segment”) = (G-0373, SRT, “Image Mode”) = (GEU-106-0024, 99GEMS, “Tissue Doppler Imaging”)</p>

		(G-C036, SRT, "Measurement Method") = (GEU-106-0020, 99GEMS, "Tissue Synchronization Imaging")
<p>TSI/BAS TimeToPeak Alias: BAS TimeToPeak</p>	(GEU-106-0006, 99GEMS, "Time To Peak")	(G-C0E3, SRT, "Finding Site") = (R-10075, SRT, "left ventricle basal anteroseptal segment") (G-0373, SRT, "Image Mode") = (GEU-106-0024, 99GEMS, "Tissue Doppler Imaging") (G-C036, SRT, "Measurement Method") = (GEU-106-0020, 99GEMS, "Tissue Synchronization Imaging")
<p>TSI/BL minus BS Alias: Septal Lat delay</p>	(GEU-106-0007, 99GEMS, "Septal Lateral Delay")	(G-0373, SRT, "Image Mode") = (GEU-106-0024, 99GEMS, "Tissue Doppler Imaging") (G-C036, SRT, "Measurement Method") = (GEU-106-0020, 99GEMS, "Tissue Synchronization Imaging")
<p>TSI/BP minus BAS Alias: Septal Post delay</p>	(GEU-106-0008, 99GEMS, "Septal Posterior Delay")	(G-0373, SRT, "Image Mode") = (GEU-106-0024, 99GEMS, "Tissue Doppler Imaging") (G-C036, SRT, "Measurement Method") = (GEU-106-0020, 99GEMS, "Tissue Synchronization Imaging")
<p>TSI/Basal max delay Alias: Basal seg. Max diff</p>	(GEU-106-0009, 99GEMS, "Basal Segments Maximum Difference")	(G-0373, SRT, "Image Mode") = (GEU-106-0024, 99GEMS, "Tissue Doppler Imaging") (G-C036, SRT, "Measurement Method") = (GEU-106-0020, 99GEMS, "Tissue Synchronization Imaging")
<p>TSI/Basal stdev Alias: Basal stdev</p>	(GEU-106-0010, 99GEMS, "Basal Standard Deviation")	(G-0373, SRT, "Image Mode") = (GEU-106-0024, 99GEMS, "Tissue Doppler Imaging") (G-C036, SRT, "Measurement Method") = (GEU-106-0020, 99GEMS, "Tissue Synchronization Imaging")
<p>TSI/All segments max delay</p>	(GEU-106-0012, 99GEMS, "All Segments Maximum")	(G-0373, SRT, "Image Mode") = (GEU-106-0024, 99GEMS, "Tissue Doppler Imaging")

Alias: All seg. Max diff.	Difference")	(G-C036, SRT, "Measurement Method") = (GEU-106-0020, 99GEMS, "Tissue Synchronization Imaging")
TSI/All segments stdev Alias: All segments stdev	(GEU-106-0012, 99GEMS, "All Segments Standard Deviation")	(G-0373, SRT, "Image Mode") = (GEU-106-0024, 99GEMS, "Tissue Doppler Imaging") (G-C036, SRT, "Measurement Method") = (GEU-106-0020, 99GEMS, "Tissue Synchronization Imaging")
CO(A-L) Alias: CO(A-L)	(F-32100, SRT, "Cardiac Output")	(G-C0E3, SRT, "Finding Site") = (T-32600, SRT, "Left Ventricle") (G-C036, SRT, "Measurement Method") = (125205, DCM, "Area-Length Single Plane")
CO(A-L A4C)/AutoHR Alias: CO A-L A4C	(F-32100, SRT, "Cardiac Output")	(G-C0E3, SRT, "Finding Site") = (T-32600, SRT, "Left Ventricle") (111031, DCM, "Image View") = (G-A19C, SRT, "Apical four chamber") (G-C036, SRT, "Measurement Method") = (125205, DCM, "Area-Length Single Plane")
CI(A-L A4C)/AutoHR Alias: CI A-L A4C	(F-32110, SRT, "Cardiac Index")	(G-C0E3, SRT, "Finding Site") = (T-32600, SRT, "Left Ventricle") (111031, DCM, "Image View") = (G-A19C, SRT, "Apical four chamber") (G-C036, SRT, "Measurement Method") = (125205, DCM, "Area-Length Single Plane")
CO(MOD A4C)/AutoHR Alias: CO MOD A4C	(F-32100, SRT, "Cardiac Output")	(G-C0E3, SRT, "Finding Site") = (T-32600, SRT, "Left Ventricle") (111031, DCM, "Image View") = (G-A19C, SRT, "Apical four chamber") (G-C036, SRT, "Measurement Method") = (125208, DCM, "Method of Disks, Single Plane")
CI(MOD A4C)/AutoHR Alias: CI MOD A4C	(F-32110, SRT, "Cardiac Index")	(G-C0E3, SRT, "Finding Site") = (T-32600, SRT, "Left Ventricle") (111031, DCM, "Image View") = (G-A19C, SRT, "Apical four chamber")

		(G-C036, SRT, "Measurement Method") = (125208, DCM, "Method of Disks, Single Plane")
CO(A-L A2C)/AutoHR Alias: CO A-L A2C	(F-32100, SRT, "Cardiac Output")	(G-C0E3, SRT, "Finding Site") = (T-32600, SRT, "Left Ventricle") (111031, DCM, "Image View") = (G-A19B, SRT, "Apical two chamber") (G-C036, SRT, "Measurement Method") = (125205, DCM, "Area-Length Single Plane")
CI(A-L A2C)/AutoHR Alias: CI A-L A2C	(F-32110, SRT, "Cardiac Index")	(G-C0E3, SRT, "Finding Site") = (T-32600, SRT, "Left Ventricle") (111031, DCM, "Image View") = (G-A19B, SRT, "Apical two chamber") (G-C036, SRT, "Measurement Method") = (125205, DCM, "Area-Length Single Plane")
CO(MOD A2C)/AutoHR Alias: CO MOD A2C	(F-32100, SRT, "Cardiac Output")	(G-C0E3, SRT, "Finding Site") = (T-32600, SRT, "Left Ventricle") (111031, DCM, "Image View") = (G-A19B, SRT, "Apical two chamber") (G-C036, SRT, "Measurement Method") = (125208, DCM, "Method of Disks, Single Plane")
CI(MOD A2C)/AutoHR Alias: CI MOD A2C	(F-32110, SRT, "Cardiac Index")	(G-C0E3, SRT, "Finding Site") = (T-32600, SRT, "Left Ventricle") (111031, DCM, "Image View") = (G-A19B, SRT, "Apical two chamber") (G-C036, SRT, "Measurement Method") = (125208, DCM, "Method of Disks, Single Plane")
CO(A-L LAX)/AutoHR Alias: CO A-L LAX	(F-32100, SRT, "Cardiac Output")	(G-C0E3, SRT, "Finding Site") = (T-32600, SRT, "Left Ventricle") (111031, DCM, "Image View") = (G-0395, SRT, "Apical long axis") (G-C036, SRT, "Measurement Method") = (125205, DCM, "Area-Length Single Plane")
CI(A-L LAX)/AutoHR	(F-32110, SRT, "Cardiac Index")	(G-C0E3, SRT, "Finding Site") = (T-32600, SRT, "Left Ventricle") (111031, DCM, "Image View") =

Alias: CI A-L LAX		(G-0395, SRT, "Apical long axis") (G-C036, SRT, "Measurement Method") = (125205, DCM, "Area-Length Single Plane")
CO(MOD LAX)/AutoHR Alias: CO MOD LAX	(F-32100, SRT, "Cardiac Output")	(G-C0E3, SRT, "Finding Site") = (T-32600, SRT, "Left Ventricle") = (111031, DCM, "Image View") = (G-0395, SRT, "Apical long axis") (G-C036, SRT, "Measurement Method") = (125208, DCM, "Method of Disks, Single Plane")
CI(MOD LAX)/AutoHR Alias: CI MOD LAX	(F-32110, SRT, "Cardiac Index")	(G-C0E3, SRT, "Finding Site") = (T-32600, SRT, "Left Ventricle") (111031, DCM, "Image View") = (G-0395, SRT, "Apical long axis") (G-C036, SRT, "Measurement Method") = (125208, DCM, "Method of Disks, Single Plane")
LVEDV(MOD BP)_03 Alias: LVEDV MOD BP	(18026-5, LN, "Left Ventricular End Diastolic Volume")	(G-C036, SRT, "Measurement Method") = (125207, DCM, "Method of Disks, Biplane")
LVESV(MOD BP)_03 Alias: LVESV MOD BP	(18148-7, LN, "Left Ventricular End Systolic Volume")	(G-C036, SRT, "Measurement Method") = (125207, DCM, "Method of Disks, Biplane")
EF(Biplane)_03 Alias: EF Biplane	(18043-0, LN, "Left Ventricular Ejection Fraction")	(G-C036, SRT, "Measurement Method") = (125207, DCM, "Method of Disks, Biplane")
SV(Biplane)_03 Alias: SV Biplane	(F-32120, SRT, "Stroke Volume")	(G-C036, SRT, "Measurement Method") = (125207, DCM, "Method of Disks, Biplane")
SI(Biplane)_03 Alias: SI Biplane	(F-00078, SRT, "Stroke Index")	(G-C036, SRT, "Measurement Method") = (125207, DCM, "Method of Disks, Biplane")
CO(Biplane)_03 Alias: CO Biplane	(F-32100, SRT, "Cardiac Output")	(G-C036, SRT, "Measurement Method") = (125207, DCM, "Method of Disks, Biplane")
CI(Biplane)_03 Alias: CI Biplane	(F-32110, SRT, "Cardiac Index")	(G-C036, SRT, "Measurement Method") = (125207, DCM, "Method of Disks, Biplane")

<p>ECG/HeartRate/Auto</p> <p>Alias: HR</p>	<p>(8867-4, LN, "Heart rate")</p>	
<p>2D/LV Major</p> <p>Alias: LV Major</p>	<p>(G-A193, SRT, "Major Axis")</p>	<p>(G-0373, SRT, "Image Mode") = (G-03A2, SRT, "2D mode") or (R-409E2, SRT, "Doppler Color Flow") depending on scan mode</p>
<p>2D/LV Minor</p> <p>Alias: LV Minor</p>	<p>(G-A194, SRT, "Minor Axis")</p>	<p>(G-0373, SRT, "Image Mode") = (G-03A2, SRT, "2D mode") or (R-409E2, SRT, "Doppler Color Flow") depending on scan mode</p>
<p>2D/IVSd</p> <p>Alias: IVSd</p>	<p>(18154-5, LN, "Interventricular Septum Diastolic Thickness")</p>	<p>(G-0373, SRT, "Image Mode") = (G-03A2, SRT, "2D mode") or (R-409E2, SRT, "Doppler Color Flow") depending on scan mode</p>
<p>2D/LVIDd</p> <p>Alias: LVIDd</p>	<p>(29436-3, LN, "Left Ventricle Internal End Diastolic Dimension")</p>	<p>(G-0373, SRT, "Image Mode") = (G-03A2, SRT, "2D mode") or (R-409E2, SRT, "Doppler Color Flow") depending on scan mode</p>
<p>2D/LVIDs</p> <p>Alias: LVIDs</p>	<p>(29438-9, LN, "Left Ventricle Internal Systolic Dimension")</p>	<p>(G-0373, SRT, "Image Mode") = (G-03A2, SRT, "2D mode") or (R-409E2, SRT, "Doppler Color Flow") depending on scan mode</p>
<p>2D/LVIDs Index</p> <p>Alias: LVIDs Index</p>	<p>(GEU-106-0029, 99GEMS, "Left Ventricle Internal Systolic Dimension Index")</p>	<p>(G-0373, SRT, "Image Mode") = (G-03A2, SRT, "2D mode") or (R-409E2, SRT, "Doppler Color Flow") depending on scan mode</p>
<p>2D/LVPWd</p> <p>Alias: LVPWd</p>	<p>(18152-9, LN, "Left Ventricle Posterior Wall Diastolic Thickness")</p>	<p>(G-0373, SRT, "Image Mode") = (G-03A2, SRT, "2D mode") or (R-409E2, SRT, "Doppler Color Flow") depending on scan mode</p>
<p>2D/LVPWs</p> <p>Alias: LVPWs</p>	<p>(18156-0, LN, "Left Ventricle Posterior Wall Systolic Thickness")</p>	<p>(G-0373, SRT, "Image Mode") = (G-03A2, SRT, "2D mode") or (R-409E2, SRT, "Doppler Color Flow") depending on scan mode</p>
<p>2D/IVSs</p> <p>Alias: IVSs</p>	<p>(18158-6, LN, "Interventricular Septum Systolic Thickness")</p>	<p>(G-0373, SRT, "Image Mode") = (G-03A2, SRT, "2D mode") or (R-409E2, SRT, "Doppler Color Flow") depending on scan mode</p>

<p>2D/LVOT Diam Alias: LVOT Diam</p>	<p>(G-038F, SRT, “Cardiovascular Orifice Diameter”)</p>	<p>(G-C0E3, SRT, “Finding Site”) = (T-32650, SRT, “Left Ventricle Outflow Tract”) (G-0373, SRT, “Image Mode”) = (G-03A2, SRT, “2D mode”) or (R-409E2, SRT, “Doppler Color Flow”) depending on scan mode</p>
<p>2D/LV FAC Alias: LV FAC</p>	<p>(G-0376, SRT, “Left Ventricular Fractional Area Change”)</p>	<p>(G-0373, SRT, “Image Mode”) = (G-03A2, SRT, “2D mode”)</p>
<p>2D/EDV(Teich) Alias: EDV(Teich)</p>	<p>(18026-5, LN, “Left Ventricular End Diastolic Volume”)</p>	<p>(G-0373, SRT, “Image Mode”) = (G-03A2, SRT, “2D mode”) or (R-409E2, SRT, “Doppler Color Flow”) depending on scan mode (G-C036, SRT, “Measurement Method”) = (125209, DCM, “Teichholz”)</p>
<p>2D/ESV(Teich) Alias: ESV(Teich)</p>	<p>(18148-7, LN, “Left Ventricular End Systolic Volume”)</p>	<p>(G-0373, SRT, “Image Mode”) = (G-03A2, SRT, “2D mode”) or (R-409E2, SRT, “Doppler Color Flow”) depending on scan mode (G-C036, SRT, “Measurement Method”) = (125209, DCM, “Teichholz”)</p>
<p>2D/EF(Teich) Alias: EF(Teich)</p>	<p>(18043-0, LN, “Left Ventricular Ejection Fraction”)</p>	<p>(G-0373, SRT, “Image Mode”) = (G-03A2, SRT, “2D mode”) or (R-409E2, SRT, “Doppler Color Flow”) depending on scan mode (G-C036, SRT, “Measurement Method”) = (125209, DCM, “Teichholz”)</p>
<p>2D/EDV(Cube) Alias: EDV(Cube)</p>	<p>(18026-5, LN, “Left Ventricular End Diastolic Volume”)</p>	<p>(G-0373, SRT, “Image Mode”) = (G-03A2, SRT, “2D mode”) or (R-409E2, SRT, “Doppler Color Flow”) depending on scan mode (G-C036, SRT, “Measurement Method”) = (125206, DCM, “Cube Method”)</p>
<p>2D/ESV(Cube) Alias: ESV(Cube)</p>	<p>(18148-7, LN, “Left Ventricular End Systolic Volume”)</p>	<p>(G-0373, SRT, “Image Mode”) = (G-03A2, SRT, “2D mode”) or (R-409E2, SRT, “Doppler Color Flow”) depending on scan mode (G-C036, SRT, “Measurement Method”) = (125206, DCM,</p>

		“Cube Method”)
2D/EF(Cube) Alias: EF(Cube)	(18043-0, LN, “Left Ventricular Ejection Fraction”)	(G-0373, SRT, “Image Mode”) = (G-03A2, SRT, “2D mode”) or (R-409E2, SRT, “Doppler Color Flow”) depending on scan mode (G-C036, SRT, “Measurement Method”) = (125206, DCM, “Cube Method”)
2D/%FS Alias: %FS	(18051-3, LN, “Left Ventricular Fractional Shortening”)	(G-0373, SRT, “Image Mode”) = (G-03A2, SRT, “2D mode”) or (R-409E2, SRT, “Doppler Color Flow”) depending on scan mode
2D/%IVS Thck Alias: %IVS Thck	(18054-7, LN, “Interventricular Septum % Thickening”)	(G-0373, SRT, “Image Mode”) = (G-03A2, SRT, “2D mode”) or (R-409E2, SRT, “Doppler Color Flow”) depending on scan mode
2D/%LVPW Thck Alias: %LVPW Thck	(18053-9, LN, “Left Ventricle Posterior Wall % Thickening”)	(G-0373, SRT, “Image Mode”) = (G-03A2, SRT, “2D mode”) or (R-409E2, SRT, “Doppler Color Flow”) depending on scan mode
2D/SV(Teich) Alias: SV(Teich)	(F-32120, SRT, “Stroke Volume”)	(G-C0E3, SRT, “Finding Site”) = (T-32600, SRT, “Left Ventricle”) (G-0373, SRT, “Image Mode”) = (G-03A2, SRT, “2D mode”) or (R-409E2, SRT, “Doppler Color Flow”) depending on scan mode (G-C036, SRT, “Measurement Method”) = (125209, DCM, “Teichholz”)
2D/SI(Teich) Alias: SI(Teich)	(F-00078, SRT, “Stroke Index”)	(G-C0E3, SRT, “Finding Site”) = (T-32600, SRT, “Left Ventricle”) (G-0373, SRT, “Image Mode”) = (G-03A2, SRT, “2D mode”) or (R-409E2, SRT, “Doppler Color Flow”) depending on scan mode (G-C036, SRT, “Measurement Method”) = (125209, DCM, “Teichholz”)
2D/CO(Teich) Alias: CO(Teich)	(F-32100, SRT, “Cardiac Output”)	(G-C0E3, SRT, “Finding Site”) = (T-32600, SRT, “Left Ventricle”) (G-0373, SRT, “Image Mode”) = (G-03A2, SRT, “2D mode”) or (R-409E2, SRT, “Doppler Color Flow”) depending on scan mode

		(G-C036, SRT, "Measurement Method") = (125209, DCM, "Teichholz")
<p>2D/CI(Teich) Alias: CI(Teich)</p>	(F-32110, SRT, "Cardiac Index")	(G-C0E3, SRT, "Finding Site") = (T-32600, SRT, "Left Ventricle") (G-0373, SRT, "Image Mode") = (G-03A2, SRT, "2D mode") or (R-409E2, SRT, "Doppler Color Flow") depending on scan mode (G-C036, SRT, "Measurement Method") = (125209, DCM, "Teichholz")
<p>2D/SV(Cube) Alias: SV(Cube)</p>	(F-32120, SRT, "Stroke Volume")	(G-C0E3, SRT, "Finding Site") = (T-32600, SRT, "Left Ventricle") (G-0373, SRT, "Image Mode") = (G-03A2, SRT, "2D mode") or (R-409E2, SRT, "Doppler Color Flow") depending on scan mode (G-C036, SRT, "Measurement Method") = (125206, DCM, "Cube Method")
<p>2D/SI(Cube) Alias: SI(Cube)</p>	(F-00078, SRT, "Stroke Index")	(G-C0E3, SRT, "Finding Site") = (T-32600, SRT, "Left Ventricle") (G-0373, SRT, "Image Mode") = (G-03A2, SRT, "2D mode") or (R-409E2, SRT, "Doppler Color Flow") depending on scan mode (G-C036, SRT, "Measurement Method") = (125206, DCM, "Cube Method")
<p>2D/CO(Cube) Alias: CO(Cube)</p>	(F-32100, SRT, "Cardiac Output")	(G-C0E3, SRT, "Finding Site") = (T-32600, SRT, "Left Ventricle") (G-0373, SRT, "Image Mode") = (G-03A2, SRT, "2D mode") or (R-409E2, SRT, "Doppler Color Flow") depending on scan mode (G-C036, SRT, "Measurement Method") = (125206, DCM, "Cube Method")
<p>2D/CI(Cube) Alias: CI(Cube)</p>	(F-32110, SRT, "Cardiac Index")	(G-C0E3, SRT, "Finding Site") = (T-32600, SRT, "Left Ventricle") (G-0373, SRT, "Image Mode") = (G-03A2, SRT, "2D mode") or (R-409E2, SRT, "Doppler Color Flow") depending on scan mode (G-C036, SRT, "Measurement Method") = (125206, DCM, "Cube Method")

		“Cube Method”)
2D/LVd Mass Alias: LVd Mass	(18087-7, LN, “Left Ventricle Mass”)	(G-0373, SRT, “Image Mode”) = (G-03A2, SRT, “2D mode”) or (R-409E2, SRT, “Doppler Color Flow”) depending on scan mode (R-4089A, SRT, “Cardiac Cycle Point”) = (F-32010, SRT, “Diastole”)
2D/LVs Mass Alias: LVs Mass	(18087-7, LN, “Left Ventricle Mass”)	(G-0373, SRT, “Image Mode”) = (G-03A2, SRT, “2D mode”) or (R-409E2, SRT, “Doppler Color Flow”) depending on scan mode (R-4089A, SRT, “Cardiac Cycle Point”) = (F-32020, SRT, “Systole”)
2D/LVd Mass/ASE Alias: LVd Mass (ASE)	(18087-7, LN, “Left Ventricle Mass”)	(G-0373, SRT, “Image Mode”) = (G-03A2, SRT, “2D mode”) or (R-409E2, SRT, “Doppler Color Flow”) depending on scan mode (R-4089A, SRT, “Cardiac Cycle Point”) = (F-32010, SRT, “Diastole”) (G-C036, SRT, “Measurement Method”) = (125221, DCM, “Left Ventricle Mass by M-mode”)
2D/LVs Mass/ASE Alias: LVs Mass (ASE)	(18087-7, LN, “Left Ventricle Mass”)	(G-0373, SRT, “Image Mode”) = (G-03A2, SRT, “2D mode”) or (R-409E2, SRT, “Doppler Color Flow”) depending on scan mode (R-4089A, SRT, “Cardiac Cycle Point”) = (F-32020, SRT, “Systole”) (G-C036, SRT, “Measurement Method”) = (125221, DCM, “Left Ventricle Mass by M-mode”)
2D/LVA diastole Alias: LVA (d)	(G-0375, SRT, “Left Ventricular Diastolic Area”)	(G-0373, SRT, “Image Mode”) = (G-03A2, SRT, “2D mode”) or (R-409E2, SRT, “Doppler Color Flow”) depending on scan mode
2D/LVA systole Alias: LVA (s)	(G-0374, SRT, “Left Ventricular Systolic Area”)	(G-0373, SRT, “Image Mode”) = (G-03A2, SRT, “2D mode”) or (R-409E2, SRT, “Doppler Color Flow”) depending on scan mode
2D/SAX/LVA diastole	(G-0375, SRT, “Left	(G-0373, SRT, “Image Mode”) =

<p>Alias: LVA (d)</p>	<p>Ventricular Diastolic Area")</p>	<p>(G-03A2, SRT, "2D mode") or (R-409E2, SRT, "Doppler Color Flow") depending on scan mode (111031, DCM, "Image View") = (G-0397, SRT, "Parasternal short axis")</p>
<p>2D/SAX/LVA systole Alias: LVA (s)</p>	<p>(G-0374, SRT, "Left Ventricular Systolic Area")</p>	<p>(G-0373, SRT, "Image Mode") = (G-03A2, SRT, "2D mode") or (R-409E2, SRT, "Doppler Color Flow") depending on scan mode (111031, DCM, "Image View") = (G-0397, SRT, "Parasternal short axis")</p>
<p>2D/SAX/LVAepi diastole Alias: LVAepi (d)</p>	<p>(59093-5, LN, "Epicardial Area")</p>	<p>(G-0373, SRT, "Image Mode") = (G-03A2, SRT, "2D mode") or (R-409E2, SRT, "Doppler Color Flow") depending on scan mode (111031, DCM, "Image View") = (G-0397, SRT, "Parasternal short axis") (R-4089A, SRT, "Cardiac Cycle Point") = (F-32010, SRT, "Diastole")</p>
<p>2D/SAX/LVAepi systole Alias: LVAepi (s)</p>	<p>(59093-5, LN, "Epicardial Area")</p>	<p>(G-0373, SRT, "Image Mode") = (G-03A2, SRT, "2D mode") or (R-409E2, SRT, "Doppler Color Flow") depending on scan mode (111031, DCM, "Image View") = (G-0397, SRT, "Parasternal short axis") (R-4089A, SRT, "Cardiac Cycle Point") = (F-32020, SRT, "Systole")</p>
<p>2D/SAX/LVAend diastole Alias: LVAend (d)</p>	<p>(59094-3, LN, "Endocardial Area")</p>	<p>(G-0373, SRT, "Image Mode") = (G-03A2, SRT, "2D mode") or (R-409E2, SRT, "Doppler Color Flow") depending on scan mode (111031, DCM, "Image View") = (G-0397, SRT, "Parasternal short axis") (R-4089A, SRT, "Cardiac Cycle Point") = (F-32010, SRT, "Diastole")</p>
<p>2D/SAX/LVAend systole Alias: LVAend (s)</p>	<p>(59094-3, LN, "Endocardial Area")</p>	<p>(G-0373, SRT, "Image Mode") = (G-03A2, SRT, "2D mode") or (R-409E2, SRT, "Doppler Color Flow") depending on scan mode</p>

		(111031, DCM, "Image View") = (G-0397, SRT, "Parasternal short axis") (R-4089A, SRT, "Cardiac Cycle Point") = (F-32020, SRT, "Systole")
2D/LVOT Area Alias: LVOT Area	(G-038E, SRT, "Cardiovascular Orifice Area")	(G-C0E3, SRT, "Finding Site") = (T-32650, SRT, "Left Ventricle Outflow Tract") (G-0373, SRT, "Image Mode") = (G-03A2, SRT, "2D mode") or (R-409E2, SRT, "Doppler Color Flow") depending on scan mode
2D/EDV(A-L) Alias: EDV(A-L)	(18026-5, LN, "Left Ventricular End Diastolic Volume")	(G-0373, SRT, "Image Mode") = (G-03A2, SRT, "2D mode") or (R-409E2, SRT, "Doppler Color Flow") depending on scan mode (G-C036, SRT, "Measurement Method") = (125205, DCM, "Area-Length Single Plane")
2D/EDV(MOD) Alias: EDV(MOD)	(18026-5, LN, "Left Ventricular End Diastolic Volume")	(G-0373, SRT, "Image Mode") = (G-03A2, SRT, "2D mode") or (R-409E2, SRT, "Doppler Color Flow") depending on scan mode (G-C036, SRT, "Measurement Method") = (125208, DCM, "Method of Disks, Single Plane")
2D/ESV(A-L) Alias: ESV(A-L)	(18148-7, LN, "Left Ventricular End Systolic Volume")	(G-0373, SRT, "Image Mode") = (G-03A2, SRT, "2D mode") or (R-409E2, SRT, "Doppler Color Flow") depending on scan mode (G-C036, SRT, "Measurement Method") = (125205, DCM, "Area-Length Single Plane")
2D/ESV(MOD) Alias: ESV(MOD)	(18148-7, LN, "Left Ventricular End Systolic Volume")	(G-0373, SRT, "Image Mode") = (G-03A2, SRT, "2D mode") or (R-409E2, SRT, "Doppler Color Flow") depending on scan mode (G-C036, SRT, "Measurement Method") = (125208, DCM, "Method of Disks, Single Plane")
2D/EF(A-L) Alias: EF(A-L)	(18043-0, LN, "Left Ventricular Ejection Fraction")	(G-0373, SRT, "Image Mode") = (G-03A2, SRT, "2D mode") or (R-409E2, SRT, "Doppler Color Flow") depending on scan mode

		(G-C036, SRT, "Measurement Method") = (125205, DCM, "Area-Length Single Plane")
<p>2D/SV(A-L) Alias: SV(A-L)</p>	(F-32120, SRT, "Stroke Volume")	(G-C0E3, SRT, "Finding Site") = (T-32600, SRT, "Left Ventricle") (G-0373, SRT, "Image Mode") = (G-03A2, SRT, "2D mode") or (R-409E2, SRT, "Doppler Color Flow") depending on scan mode (G-C036, SRT, "Measurement Method") = (125205, DCM, "Area-Length Single Plane")
<p>2D/SI(A-L) Alias: SI(A-L)</p>	(F-00078, SRT, "Stroke Index")	(G-C0E3, SRT, "Finding Site") = (T-32600, SRT, "Left Ventricle") (G-0373, SRT, "Image Mode") = (G-03A2, SRT, "2D mode") or (R-409E2, SRT, "Doppler Color Flow") depending on scan mode (G-C036, SRT, "Measurement Method") = (125205, DCM, "Area-Length Single Plane")
<p>2D/EF(MOD) Alias: EF(MOD)</p>	(18043-0, LN, "Left Ventricular Ejection Fraction")	(G-0373, SRT, "Image Mode") = (G-03A2, SRT, "2D mode") or (R-409E2, SRT, "Doppler Color Flow") depending on scan mode (G-C036, SRT, "Measurement Method") = (125208, DCM, "Method of Disks, Single Plane")
<p>2D/SV(MOD) Alias: SV(MOD)</p>	(F-32120, SRT, "Stroke Volume")	(G-C0E3, SRT, "Finding Site") = (T-32600, SRT, "Left Ventricle") (G-0373, SRT, "Image Mode") = (G-03A2, SRT, "2D mode") or (R-409E2, SRT, "Doppler Color Flow") depending on scan mode (G-C036, SRT, "Measurement Method") = (125208, DCM, "Method of Disks, Single Plane")
<p>2D/SI(MOD) Alias: SI(MOD)</p>	(F-00078, SRT, "Stroke Index")	(G-C0E3, SRT, "Finding Site") = (T-32600, SRT, "Left Ventricle") (G-0373, SRT, "Image Mode") = (G-03A2, SRT, "2D mode") or (R-409E2, SRT, "Doppler Color Flow") depending on scan mode (G-C036, SRT, "Measurement Method") = (125208, DCM, "Method of Disks, Single Plane")

LVLd(A4C) Alias: LVLd A4C	(18074-5, LN, "Left Ventricular Major Axis Diastolic Dimension, 4-chamber view")	
LVAAd(A4C) Alias: LVAAd A4C	(G-0375, SRT, "Left Ventricular Diastolic Area")	(111031, DCM, "Image View") = (G-A19C, SRT, "Apical four chamber")
LVEDV(A-L A4C) Alias: LVEDV A-L A4C	(18026-5, LN, "Left Ventricular End Diastolic Volume")	(111031, DCM, "Image View") = (G-A19C, SRT, "Apical four chamber") (G-C036, SRT, "Measurement Method") = (125205, DCM, "Area-Length Single Plane")
LVEDV Index(A-L A4C) Alias: LVEDV Index A-L A4C	(18026-5, LN, "Left Ventricular End Diastolic Volume")	(111031, DCM, "Image View") = (G-A19C, SRT, "Apical four chamber") (G-C036, SRT, "Measurement Method") = (125205, DCM, "Area-Length Single Plane")
LVEDV(MOD A4C) Alias: LVEDV MOD A4C	(18026-5, LN, "Left Ventricular End Diastolic Volume")	(111031, DCM, "Image View") = (G-A19C, SRT, "Apical four chamber") (G-C036, SRT, "Measurement Method") = (125208, DCM, "Method of Disks, Single Plane")
LVEDV Index(MOD A4C) Alias: LVEDV Index MOD A4C	(18026-5, LN, "Left Ventricular End Diastolic Volume")	(111031, DCM, "Image View") = (G-A19C, SRT, "Apical four chamber") (G-C036, SRT, "Measurement Method") = (125208, DCM, "Method of Disks, Single Plane")
LVLs(A4C) Alias: LVLs A4C	(18075-2, LN, "Left Ventricular Major Axis Systolic Dimension, 4-chamber view")	
LVAAs(A4C) Alias: LVAAs A4C	(G-0374, SRT, "Left Ventricular Systolic Area")	(111031, DCM, "Image View") = (G-A19C, SRT, "Apical four chamber")
LVESV(A-L A4C) Alias: LVESV A-L A4C	(18148-7, LN, "Left Ventricular End Systolic Volume")	(111031, DCM, "Image View") = (G-A19C, SRT, "Apical four chamber") (G-C036, SRT, "Measurement

		Method”) = (125205, DCM, “Area-Length Single Plane”)
LVESV Index(A-L A4C) Alias: LVESV Index A-L A4C	(18148-7, LN, “Left Ventricular End Systolic Volume”)	(111031, DCM, “Image View”) = (G-A19C, SRT, “Apical four chamber”) (G-C036, SRT, “Measurement Method”) = (125205, DCM, “Area-Length Single Plane”)
LVESV(MOD A4C) Alias: LVESV MOD A4C	(18148-7, LN, “Left Ventricular End Systolic Volume”)	(111031, DCM, “Image View”) = (G-A19C, SRT, “Apical four chamber”) (G-C036, SRT, “Measurement Method”) = (125208, DCM, “Method of Disks, Single Plane”)
LVESV Index(MOD A4C) Alias: LVESV Index MOD A4C	(18148-7, LN, “Left Ventricular End Systolic Volume”)	(111031, DCM, “Image View”) = (G-A19C, SRT, “Apical four chamber”) (G-C036, SRT, “Measurement Method”) = (125208, DCM, “Method of Disks, Single Plane”)
EF(A-L A4C) Alias: EF A-L A4C	(18043-0, LN, “Left Ventricular Ejection Fraction”)	(111031, DCM, “Image View”) = (G-A19C, SRT, “Apical four chamber”) (G-C036, SRT, “Measurement Method”) = (125205, DCM, “Area-Length Single Plane”)
SV(A-L A4C) Alias: SV A-L A4C	(F-32120, SRT, “Stroke Volume”)	(G-C0E3, SRT, “Finding Site”) = (T-32600, SRT, “Left Ventricle”) (111031, DCM, “Image View”) = (G-A19C, SRT, “Apical four chamber”) (G-C036, SRT, “Measurement Method”) = (125205, DCM, “Area-Length Single Plane”)
SI(A-L A4C) Alias: SI A-L A4C	(F-00078, SRT, “Stroke Index”)	(G-C0E3, SRT, “Finding Site”) = (T-32600, SRT, “Left Ventricle”) (111031, DCM, “Image View”) = (G-A19C, SRT, “Apical four chamber”) (G-C036, SRT, “Measurement Method”) = (125205, DCM, “Area-Length Single Plane”)
CO(A-L A4C)	(F-32100, SRT, “Cardiac	(G-C0E3, SRT, “Finding Site”) = (T-32600, SRT, “Left Ventricle”)

Alias: CO A-L A4C	Output")	(111031, DCM, "Image View") = (G-A19C, SRT, "Apical four chamber") (G-C036, SRT, "Measurement Method") = (125205, DCM, "Area-Length Single Plane")
CI(A-L A4C) Alias: CI A-L A4C	(F-32110, SRT, "Cardiac Index")	(G-C0E3, SRT, "Finding Site") = (T-32600, SRT, "Left Ventricle") (111031, DCM, "Image View") = (G-A19C, SRT, "Apical four chamber") (G-C036, SRT, "Measurement Method") = (125205, DCM, "Area-Length Single Plane")
EF(MOD A4C) Alias: LVEF MOD A4C	(18043-0, LN, "Left Ventricular Ejection Fraction")	(111031, DCM, "Image View") = (G-A19C, SRT, "Apical four chamber") (G-C036, SRT, "Measurement Method") = (125208, DCM, "Method of Disks, Single Plane")
SV(MOD A4C) Alias: SV MOD A4C	(F-32120, SRT, "Stroke Volume")	(G-C0E3, SRT, "Finding Site") = (T-32600, SRT, "Left Ventricle") (111031, DCM, "Image View") = (G-A19C, SRT, "Apical four chamber") (G-C036, SRT, "Measurement Method") = (125208, DCM, "Method of Disks, Single Plane")
SI(MOD A4C) Alias: SI MOD A4C	(F-00078, SRT, "Stroke Index")	(G-C0E3, SRT, "Finding Site") = (T-32600, SRT, "Left Ventricle") (111031, DCM, "Image View") = (G-A19C, SRT, "Apical four chamber") (G-C036, SRT, "Measurement Method") = (125208, DCM, "Method of Disks, Single Plane")
CO(MOD A4C) Alias: CO MOD A4C	(F-32100, SRT, "Cardiac Output")	(G-C0E3, SRT, "Finding Site") = (T-32600, SRT, "Left Ventricle") (111031, DCM, "Image View") = (G-A19C, SRT, "Apical four chamber") (G-C036, SRT, "Measurement Method") = (125208, DCM, "Method of Disks, Single Plane")
CI(MOD A4C)	(F-32110, SRT, "Cardiac	(G-C0E3, SRT, "Finding Site") =

Alias: CI MOD A4C	Index")	(T-32600, SRT, "Left Ventricle") (111031, DCM, "Image View") = (G-A19C, SRT, "Apical four chamber") (G-C036, SRT, "Measurement Method") = (125208, DCM, "Method of Disks, Single Plane")
LVLd(A2C) Alias: LVLd A2C	(18072-9, LN, "Left Ventricular Major Axis Diastolic Dimension, 2-chamber view")	
LVAd(A2C) Alias: LVAd A2C	(G-0375, SRT, "Left Ventricular Diastolic Area")	(111031, DCM, "Image View") = (G-A19B, SRT, "Apical two chamber")
LVEDV(A-L A2C) Alias: LVEDV A-L A2C	(18026-5, LN, "Left Ventricular End Diastolic Volume")	(111031, DCM, "Image View") = (G-A19B, SRT, "Apical two chamber") (G-C036, SRT, "Measurement Method") = (125205, DCM, "Area-Length Single Plane")
LVEDV(MOD A2C) Alias: LVEDV MOD A2C	(18026-5, LN, "Left Ventricular End Diastolic Volume")	(111031, DCM, "Image View") = (G-A19B, SRT, "Apical two chamber") (G-C036, SRT, "Measurement Method") = (125208, DCM, "Method of Disks, Single Plane")
LVLs(A2C) Alias: LVLs A2C	(18073-7, LN, "Left Ventricular Major Axis Systolic Dimension, 2-chamber view")	
LVAs(A2C) Alias: LVAs A2C	(G-0374, SRT, "Left Ventricular Systolic Area")	(111031, DCM, "Image View") = (G-A19B, SRT, "Apical two chamber")
LVESV(A-L A2C) Alias: LVESV A-L A2C	(18148-7, LN, "Left Ventricular End Systolic Volume")	(111031, DCM, "Image View") = (G-A19B, SRT, "Apical two chamber") (G-C036, SRT, "Measurement Method") = (125205, DCM, "Area-Length Single Plane")
LVESV(MOD A2C) Alias: LVESV MOD A2C	(18148-7, LN, "Left Ventricular End Systolic Volume")	(111031, DCM, "Image View") = (G-A19B, SRT, "Apical two chamber")

		(G-C036, SRT, "Measurement Method") = (125208, DCM, "Method of Disks, Single Plane")
EF(A-L A2C) Alias: EF A-L A2C	(18043-0, LN, "Left Ventricular Ejection Fraction")	(111031, DCM, "Image View") = (G-A19B, SRT, "Apical two chamber") (G-C036, SRT, "Measurement Method") = (125205, DCM, "Area-Length Single Plane")
SV(A-L A2C) Alias: SV A-L A2C	(F-32120, SRT, "Stroke Volume")	(G-C0E3, SRT, "Finding Site") = (T-32600, SRT, "Left Ventricle") (111031, DCM, "Image View") = (G-A19B, SRT, "Apical two chamber") (G-C036, SRT, "Measurement Method") = (125205, DCM, "Area-Length Single Plane")
SI(A-L A2C) Alias: SI A-L A2C	(F-00078, SRT, "Stroke Index")	(G-C0E3, SRT, "Finding Site") = (T-32600, SRT, "Left Ventricle") (111031, DCM, "Image View") = (G-A19B, SRT, "Apical two chamber") (G-C036, SRT, "Measurement Method") = (125205, DCM, "Area-Length Single Plane")
CO(A-L A2C) Alias: CO A-L A2C	(F-32100, SRT, "Cardiac Output")	(G-C0E3, SRT, "Finding Site") = (T-32600, SRT, "Left Ventricle") (111031, DCM, "Image View") = (G-A19B, SRT, "Apical two chamber") (G-C036, SRT, "Measurement Method") = (125205, DCM, "Area-Length Single Plane")
CI(A-L A2C) Alias: CI A-L A2C	(F-32110, SRT, "Cardiac Index")	(G-C0E3, SRT, "Finding Site") = (T-32600, SRT, "Left Ventricle") (111031, DCM, "Image View") = (G-A19B, SRT, "Apical two chamber") (G-C036, SRT, "Measurement Method") = (125205, DCM, "Area-Length Single Plane")
EF(MOD A2C) Alias: LVEF MOD A2C	(18043-0, LN, "Left Ventricular Ejection Fraction")	(111031, DCM, "Image View") = (G-A19B, SRT, "Apical two chamber") (G-C036, SRT, "Measurement

		Method”) = (125208, DCM, “Method of Disks, Single Plane”)
<p>SV(MOD A2C) Alias: SV MOD A2C</p>	<p>(F-32120, SRT, “Stroke Volume”)</p>	<p>(G-C0E3, SRT, “Finding Site”) = (T-32600, SRT, “Left Ventricle”) (111031, DCM, “Image View”) = (G-A19B, SRT, “Apical two chamber”) (G-C036, SRT, “Measurement Method”) = (125208, DCM, “Method of Disks, Single Plane”)</p>
<p>SI(MOD A2C) Alias: SI MOD A2C</p>	<p>(F-00078, SRT, “Stroke Index”)</p>	<p>(G-C0E3, SRT, “Finding Site”) = (T-32600, SRT, “Left Ventricle”) (111031, DCM, “Image View”) = (G-A19B, SRT, “Apical two chamber”) (G-C036, SRT, “Measurement Method”) = (125208, DCM, “Method of Disks, Single Plane”)</p>
<p>CO(MOD A2C) Alias: CO MOD A2C</p>	<p>(F-32100, SRT, “Cardiac Output”)</p>	<p>(G-C0E3, SRT, “Finding Site”) = (T-32600, SRT, “Left Ventricle”) (111031, DCM, “Image View”) = (G-A19B, SRT, “Apical two chamber”) (G-C036, SRT, “Measurement Method”) = (125208, DCM, “Method of Disks, Single Plane”)</p>
<p>CI(MOD A2C) Alias: CI MOD A2C</p>	<p>(F-32110, SRT, “Cardiac Index”)</p>	<p>(G-C0E3, SRT, “Finding Site”) = (T-32600, SRT, “Left Ventricle”) (111031, DCM, “Image View”) = (G-A19B, SRT, “Apical two chamber”) (G-C036, SRT, “Measurement Method”) = (125208, DCM, “Method of Disks, Single Plane”)</p>
<p>LVAd(LAX) Alias: LVAd LAX</p>	<p>(G-0375, SRT, “Left Ventricular Diastolic Area”)</p>	<p>(111031, DCM, “Image View”) = (G-0395, SRT, “Apical long axis”)</p>
<p>LVLd(LAX) Alias: LVLd LAX</p>	<p>(18077-8, LN, “Left Ventricle diastolic major axis”)</p>	<p>(R-4089A, SRT, “Cardiac Cycle Point”) = (F-32011, SRT, “End Diastole”) (111031, DCM, “Image View”) = (G-0395, SRT, “Apical long axis”)</p>

<p>LVLs(LAX) Alias: LVLd LAX</p>	<p>(18076-0, LN, "Left Ventricle systolic major axis")</p>	<p>(R-4089A, SRT, "Cardiac Cycle Point") = (109070, DCM, "End Systole") (111031, DCM, "Image View") = (G-0395, SRT, "Apical long axis")</p>
<p>LVEDV(A-L LAX) Alias: LVEDV A-L LAX</p>	<p>(18026-5, LN, "Left Ventricular End Diastolic Volume")</p>	<p>(111031, DCM, "Image View") = (G-0395, SRT, "Apical long axis") (G-C036, SRT, "Measurement Method") = (125205, DCM, "Area-Length Single Plane")</p>
<p>LVEDV(MOD LAX) Alias: LVEDV MOD LAX</p>	<p>(18026-5, LN, "Left Ventricular End Diastolic Volume")</p>	<p>(111031, DCM, "Image View") = (G-0395, SRT, "Apical long axis") (G-C036, SRT, "Measurement Method") = (125208, DCM, "Method of Disks, Single Plane")</p>
<p>LVA(LAX) Alias: LVA LAX</p>	<p>(G-0374, SRT, "Left Ventricular Systolic Area")</p>	<p>(111031, DCM, "Image View") = (G-0395, SRT, "Apical long axis")</p>
<p>LVESV(A-L LAX) Alias: LVESV A-L LAX</p>	<p>(18148-7, LN, "Left Ventricular End Systolic Volume")</p>	<p>(111031, DCM, "Image View") = (G-0395, SRT, "Apical long axis") (G-C036, SRT, "Measurement Method") = (125205, DCM, "Area-Length Single Plane")</p>
<p>LVESV(MOD LAX) Alias: LVESV MOD LAX</p>	<p>(18148-7, LN, "Left Ventricular End Systolic Volume")</p>	<p>(111031, DCM, "Image View") = (G-0395, SRT, "Apical long axis") (G-C036, SRT, "Measurement Method") = (125208, DCM, "Method of Disks, Single Plane")</p>
<p>EF(A-L LAX) Alias: EF A-L LAX</p>	<p>(18043-0, LN, "Left Ventricular Ejection Fraction")</p>	<p>(111031, DCM, "Image View") = (G-0395, SRT, "Apical long axis") (G-C036, SRT, "Measurement Method") = (125205, DCM, "Area-Length Single Plane")</p>
<p>SV(A-L LAX) Alias: SV A-L LAX</p>	<p>(F-32120, SRT, "Stroke Volume")</p>	<p>(G-C0E3, SRT, "Finding Site") = (T-32600, SRT, "Left Ventricle") (111031, DCM, "Image View") = (G-0395, SRT, "Apical long axis") (G-C036, SRT, "Measurement Method") = (125205, DCM, "Area-Length Single Plane")</p>
<p>SI(A-L LAX)</p>	<p>(F-00078, SRT, "Stroke</p>	<p>(G-C0E3, SRT, "Finding Site") =</p>

Alias: SI A-L LAX	Index")	(T-32600, SRT, "Left Ventricle") (111031, DCM, "Image View") = (G-0395, SRT, "Apical long axis") (G-C036, SRT, "Measurement Method") = (125205, DCM, "Area-Length Single Plane")
CO(A-L LAX) Alias: CO A-L LAX	(F-32100, SRT, "Cardiac Output")	(G-C0E3, SRT, "Finding Site") = (T-32600, SRT, "Left Ventricle") (111031, DCM, "Image View") = (G-0395, SRT, "Apical long axis") (G-C036, SRT, "Measurement Method") = (125205, DCM, "Area-Length Single Plane")
CI(A-L LAX) Alias: CI A-L LAX	(F-32110, SRT, "Cardiac Index")	(G-C0E3, SRT, "Finding Site") = (T-32600, SRT, "Left Ventricle") (111031, DCM, "Image View") = (G-0395, SRT, "Apical long axis") (G-C036, SRT, "Measurement Method") = (125205, DCM, "Area-Length Single Plane")
EF(MOD LAX) Alias: LVEF MOD LAX	(18043-0, LN, "Left Ventricular Ejection Fraction")	(111031, DCM, "Image View") = (G-0395, SRT, "Apical long axis") (G-C036, SRT, "Measurement Method") = (125208, DCM, "Method of Disks, Single Plane")
SV(MOD LAX) Alias: SV MOD LAX	(F-32120, SRT, "Stroke Volume")	(G-C0E3, SRT, "Finding Site") = (T-32600, SRT, "Left Ventricle") (111031, DCM, "Image View") = (G-0395, SRT, "Apical long axis") (G-C036, SRT, "Measurement Method") = (125208, DCM, "Method of Disks, Single Plane")
SI(MOD LAX) Alias: SI MOD LAX	(F-00078, SRT, "Stroke Index")	(G-C0E3, SRT, "Finding Site") = (T-32600, SRT, "Left Ventricle") (111031, DCM, "Image View") = (G-0395, SRT, "Apical long axis") (G-C036, SRT, "Measurement Method") = (125208, DCM, "Method of Disks, Single Plane")
CO(MOD LAX) Alias: CO MOD LAX	(F-32100, SRT, "Cardiac Output")	(G-C0E3, SRT, "Finding Site") = (T-32600, SRT, "Left Ventricle") (111031, DCM, "Image View") = (G-0395, SRT, "Apical long axis") (G-C036, SRT, "Measurement Method") = (125208, DCM, "Method of Disks, Single Plane")

		“Method of Disks, Single Plane”)
<p>CI(MOD LAX) Alias: CI MOD LAX</p>	<p>(F-32110, SRT, “Cardiac Index”)</p>	<p>(G-C0E3, SRT, “Finding Site”) = (T-32600, SRT, “Left Ventricle”) (111031, DCM, “Image View”) = (G-0395, SRT, “Apical long axis”) (G-C036, SRT, “Measurement Method”) = (125208, DCM, “Method of Disks, Single Plane”)</p>
<p>LVEDV(MOD BP) Alias: LVEDV MOD BP</p>	<p>(18026-5, LN, “Left Ventricular End Diastolic Volume”)</p>	<p>(G-C036, SRT, “Measurement Method”) = (125207, DCM, “Method of Disks, Biplane”)</p>
<p>LVEDV Index(MOD BP) Alias: LVEDV Index MOD BP</p>	<p>(18026-5, LN, “Left Ventricular End Diastolic Volume”)</p>	<p>(G-C036, SRT, “Measurement Method”) = (125207, DCM, “Method of Disks, Biplane”)</p>
<p>LVESV(MOD BP) Alias: LVESV MOD BP</p>	<p>(18148-7, LN, “Left Ventricular End Systolic Volume”)</p>	<p>(G-C036, SRT, “Measurement Method”) = (125207, DCM, “Method of Disks, Biplane”)</p>
<p>LVESV Index(MOD BP) Alias: LVESV Index MOD BP</p>	<p>(18148-7, LN, “Left Ventricular End Systolic Volume”)</p>	<p>(G-C036, SRT, “Measurement Method”) = (125207, DCM, “Method of Disks, Biplane”)</p>
<p>EF(Biplane) Alias: EF Biplane</p>	<p>(18043-0, LN, “Left Ventricular Ejection Fraction”)</p>	<p>(G-C036, SRT, “Measurement Method”) = (125207, DCM, “Method of Disks, Biplane”)</p>
<p>SV(Biplane) Alias: SV Biplane</p>	<p>(F-32120, SRT, “Stroke Volume”)</p>	<p>(G-C036, SRT, “Measurement Method”) = (125207, DCM, “Method of Disks, Biplane”)</p>
<p>SI(Biplane) Alias: SI Biplane</p>	<p>(F-00078, SRT, “Stroke Index”)</p>	<p>(G-C036, SRT, “Measurement Method”) = (125207, DCM, “Method of Disks, Biplane”)</p>
<p>CO(Biplane) Alias: CO Biplane</p>	<p>(F-32100, SRT, “Cardiac Output”)</p>	<p>(G-C036, SRT, “Measurement Method”) = (125207, DCM, “Method of Disks, Biplane”)</p>
<p>CI(Biplane) Alias: CI Biplane</p>	<p>(F-32110, SRT, “Cardiac Index”)</p>	<p>(G-C036, SRT, “Measurement Method”) = (125207, DCM, “Method of Disks, Biplane”)</p>
<p>LVLd(apical)</p>	<p>(18077-8, LN, “Left Ventricle diastolic major axis”)</p>	

Alias: LVLd apical		
LVLs(apical) Alias: LVLs apical	(18076-0, LN, “Left Ventricle systolic major axis”)	
LVAd(sax MV) Alias: LVAd sax MV	(G-0375, SRT, “Left Ventricular Diastolic Area”)	(111031, DCM, “Image View”) = (G-039A, SRT, “Parasternal short axis at the Mitral Valve level”)
LVA(sax MV) Alias: LVA(sax MV)	(G-0374, SRT, “Left Ventricular Systolic Area”)	(111031, DCM, “Image View”) = (G-039A, SRT, “Parasternal short axis at the Mitral Valve level”)
LVAd(sax PM) Alias: LVAd sax PM	(G-0375, SRT, “Left Ventricular Diastolic Area”)	(111031, DCM, “Image View”) = (G-039B, SRT, “Parasternal short axis at the Papillary Muscle level”)
LVA(sax PM) Alias: LVA(sax PM)	(G-0374, SRT, “Left Ventricular Systolic Area”)	(111031, DCM, “Image View”) = (G-039B, SRT, “Parasternal short axis at the Papillary Muscle level”)
LVAd(sax epi) Alias: LVAd sax EPI	(G-0379, SRT, “Left Ventricle Epicardial Diastolic Area, psax pap view”)	(G-0373, SRT, “Image Mode”) = (G-03A2, SRT, “2D mode”) or (R-409E2, SRT, “Doppler Color Flow”) depending on scan mode
LVA(sax epi) Alias: LVA(sax EPI)	(59093-5, LN, “Epicardial Area”)	(G-0373, SRT, “Image Mode”) = (G-03A2, SRT, “2D mode”) or (R-409E2, SRT, “Doppler Color Flow”) depending on scan mode (111031, DCM, “Image View”) = (G-039B, SRT, “Parasternal short axis at the Papillary Muscle level”) (R-4089A, SRT, “Cardiac Cycle Point”) = (F-32020, SRT, “Systole”)
LVAd(sax) Alias: LVAd sax	(G-0375, SRT, “Left Ventricular Diastolic Area”)	(111031, DCM, “Image View”) = (G-0397, SRT, “Parasternal short axis”)
LVA(sax) Alias: LVA(sax)	(G-0374, SRT, “Left Ventricular Systolic Area”)	(111031, DCM, “Image View”) = (G-0397, SRT, “Parasternal short axis”)

EDV(mod sim) Alias: EDV mod sim	(18026-5, LN, “Left Ventricular End Diastolic Volume”)	
ESV(mod sim) Alias: ESV mod sim	(18148-7, LN, “Left Ventricular End Systolic Volume”)	
EF(mod sim) Alias: EF mod sim	(18043-0, LN, “Left Ventricular Ejection Fraction”)	
SV(mod sim) Alias: SV mod sim	(F-32120, SRT, “Stroke Volume”)	(G-C0E3, SRT, “Finding Site”) = (T-32600, SRT, “Left Ventricle”)
SI(mod sim) Alias: SI mod sim	(F-00078, SRT, “Stroke Index”)	(G-C0E3, SRT, “Finding Site”) = (T-32600, SRT, “Left Ventricle”)
CO(mod sim) Alias: CO mod sim	(F-32100, SRT, “Cardiac Output”)	(G-C0E3, SRT, “Finding Site”) = (T-32600, SRT, “Left Ventricle”)
CI(mod sim) Alias: CI mod sim	(F-32110, SRT, “Cardiac Index”)	(G-C0E3, SRT, “Finding Site”) = (T-32600, SRT, “Left Ventricle”)
EDV(bullet) Alias: EDV bullet	(18026-5, LN, “Left Ventricular End Diastolic Volume”)	
ESV(bullet) Alias: ESV bullet	(18148-7, LN, “Left Ventricular End Systolic Volume”)	
EF(bullet) Alias: LVEF Bullet	(18043-0, LN, “Left Ventricular Ejection Fraction”)	
SV(bullet) Alias: SV bullet	(F-32120, SRT, “Stroke Volume”)	(G-C0E3, SRT, «Finding Site») = (T-32600, SRT, «Left Ventricle»)
SI(bullet) Alias: SI bullet	(F-00078, SRT, “Stroke Index”)	(G-C0E3, SRT, “Finding Site”) = (T-32600, SRT, “Left Ventricle”)

<p>CO(bullet) Alias: CO bullet</p>	<p>(F-32100, SRT, “Cardiac Output”)</p>	<p>(G-C0E3, SRT, “Finding Site”) = (T-32600, SRT, “Left Ventricle”)</p>
<p>CI(bullet) Alias: CI bullet</p>	<p>(F-32110, SRT, “Cardiac Index”)</p>	<p>(G-C0E3, SRT, “Finding Site”) = (T-32600, SRT, “Left Ventricle”)</p>
<p>EDV(bp el) Alias: EDV bp el</p>	<p>(18026-5, LN, “Left Ventricular End Diastolic Volume”)</p>	<p>(G-C036, SRT, “Measurement Method”) = (125211, DCM, “Biplane Ellipse”)</p>
<p>ESV(bp el) Alias: ESV bp el</p>	<p>(18148-7, LN, “Left Ventricular End Systolic Volume”)</p>	<p>(G-C036, SRT, “Measurement Method”) = (125211, DCM, “Biplane Ellipse”)</p>
<p>EF(bp el) Alias: LVEF BP-EL</p>	<p>(18043-0, LN, “Left Ventricular Ejection Fraction”)</p>	<p>(G-C036, SRT, “Measurement Method”) = (125211, DCM, “Biplane Ellipse”)</p>
<p>SV(bp el) Alias: SV bp el</p>	<p>(F-32120, SRT, “Stroke Volume”)</p>	<p>(G-C0E3, SRT, “Finding Site”) = (T-32600, SRT, “Left Ventricle”) (G-C036, SRT, “Measurement Method”) = (125211, DCM, “Biplane Ellipse”)</p>
<p>SI(bp el) Alias: SI bp el</p>	<p>(F-00078, SRT, “Stroke Index”)</p>	<p>(G-C0E3, SRT, “Finding Site”) = (T-32600, SRT, “Left Ventricle”) (G-C036, SRT, “Measurement Method”) = (125211, DCM, “Biplane Ellipse”)</p>
<p>CO(bp el) Alias: CO bp el</p>	<p>(F-32100, SRT, “Cardiac Output”)</p>	<p>(G-C0E3, SRT, “Finding Site”) = (T-32600, SRT, “Left Ventricle”) (G-C036, SRT, “Measurement Method”) = (125211, DCM, “Biplane Ellipse”)</p>
<p>CI(bp el) Alias: CI bp el</p>	<p>(F-32110, SRT, “Cardiac Index”)</p>	<p>(G-C0E3, SRT, “Finding Site”) = (T-32600, SRT, “Left Ventricle”) (G-C036, SRT, “Measurement Method”) = (125211, DCM, “Biplane Ellipse”)</p>
<p>LVd Mass(A-L) Alias: LVd Mass A-L</p>	<p>(18087-7, LN, “Left Ventricle Mass”)</p>	<p>(R-4089A, SRT, “Cardiac Cycle Point”) = (F-32010, SRT, “Diastole”) (G-C036, SRT, “Measurement Method”) = (125205, DCM, “Biplane Ellipse”)</p>

		“Area-Length Single Plane”)
<p>LVs Mass(A-L) Alias: LVs Mass A-L</p>	<p>(18087-7, LN, “Left Ventricle Mass”)</p>	<p>(R-4089A, SRT, “Cardiac Cycle Point”) = (F-32020, SRT, “Systole”) (G-C036, SRT, “Measurement Method”) = (125205, DCM, “Area-Length Single Plane”)</p>
<p>LVd Mass Index(A-L) Alias: LVd Mass I A-L</p>	<p>(GEU-106-0028, 99GEMS, “Left Ventricle Mass Index”)</p>	<p>(R-4089A, SRT, “Cardiac Cycle Point”) = (F-32010, SRT, “Diastole”) (G-C036, SRT, “Measurement Method”) = (125205, DCM, “Area-Length Single Plane”)</p>
<p>MM/IVSd Alias: IVSd</p>	<p>(18154-5, LN, “Interventricular Septum Diastolic Thickness”)</p>	<p>(G-0373, SRT, «Image Mode») = (G-0394, SRT, «M mode»)</p>
<p>MM/IVSs Alias: IVSs</p>	<p>(18158-6, LN, “Interventricular Septum Systolic Thickness”)</p>	<p>(G-0373, SRT, «Image Mode») = (G-0394, SRT, «M mode»)</p>
<p>MM/LVIDd Alias: LVIDd</p>	<p>(29436-3, LN, “Left Ventricle Internal End Diastolic Dimension”)</p>	<p>(G-0373, SRT, «Image Mode») = (G-0394, SRT, «M mode»)</p>
<p>MM/LVIDs Alias: LVIDs</p>	<p>(29438-9, LN, “Left Ventricle Internal Systolic Dimension”)</p>	<p>(G-0373, SRT, «Image Mode») = (G-0394, SRT, «M mode»)</p>
<p>MM/LVPWd Alias: LVPWd</p>	<p>(18152-9, LN, “Left Ventricle Posterior Wall Diastolic Thickness”)</p>	<p>(G-0373, SRT, «Image Mode») = (G-0394, SRT, «M mode»)</p>
<p>MM/LVPWs Alias: LVPWs</p>	<p>(18156-0, LN, “Left Ventricle Posterior Wall Systolic Thickness”)</p>	<p>(G-0373, SRT, «Image Mode») = (G-0394, SRT, «M mode»)</p>
<p>MM/EDV(Teich) Alias: EDV(Teich)</p>	<p>(18026-5, LN, “Left Ventricular End Diastolic Volume”)</p>	<p>(G-0373, SRT, “Image Mode”) = (G-0394, SRT, “M mode”) (G-C036, SRT, “Measurement Method”) = (125209, DCM, “Teichholz”)</p>
<p>MM/ESV(Teich) Alias: ESV(Teich)</p>	<p>(18148-7, LN, “Left Ventricular End Systolic Volume”)</p>	<p>(G-0373, SRT, “Image Mode”) = (G-0394, SRT, “M mode”) (G-C036, SRT, “Measurement</p>

		Method”) = (125209, DCM, “Teichholz”)
MM/EF(Teich) Alias: EF(Teich)	(18043-0, LN, “Left Ventricular Ejection Fraction”)	(G-0373, SRT, “Image Mode”) = (G-0394, SRT, “M mode”) (G-C036, SRT, “Measurement Method”) = (125209, DCM, “Teichholz”)
MM/SV(Teich) Alias: SV(Teich)	(F-32120, SRT, “Stroke Volume”)	(G-C0E3, SRT, “Finding Site”) = (T-32600, SRT, “Left Ventricle”) (G-0373, SRT, “Image Mode”) = (G-0394, SRT, “M mode”) (G-C036, SRT, “Measurement Method”) = (125209, DCM, “Teichholz”)
MM/SI(Teich) Alias: SI(Teich)	(F-00078, SRT, “Stroke Index”)	(G-C0E3, SRT, “Finding Site”) = (T-32600, SRT, “Left Ventricle”) (G-0373, SRT, “Image Mode”) = (G-0394, SRT, “M mode”) (G-C036, SRT, “Measurement Method”) = (125209, DCM, “Teichholz”)
MM/CO(Teich) Alias: CO(Teich)	(F-32100, SRT, “Cardiac Output”)	(G-C0E3, SRT, “Finding Site”) = (T-32600, SRT, “Left Ventricle”) (G-0373, SRT, “Image Mode”) = (G-0394, SRT, “M mode”) (G-C036, SRT, “Measurement Method”) = (125209, DCM, “Teichholz”)
MM/CI(Teich) Alias: CI(Teich)	(F-32110, SRT, “Cardiac Index”)	(G-C0E3, SRT, “Finding Site”) = (T-32600, SRT, “Left Ventricle”) (G-0373, SRT, “Image Mode”) = (G-0394, SRT, “M mode”) (G-C036, SRT, “Measurement Method”) = (125209, DCM, “Teichholz”)
MM/EDV(Cube) Alias: EDV(Cube)	(18026-5, LN, “Left Ventricular End Diastolic Volume”)	(G-0373, SRT, “Image Mode”) = (G-0394, SRT, “M mode”) (G-C036, SRT, “Measurement Method”) = (125206, DCM, “Cube Method”)
MM/ESV(Cube) Alias: ESV(Cube)	(18148-7, LN, “Left Ventricular End Systolic Volume”)	(G-0373, SRT, “Image Mode”) = (G-0394, SRT, “M mode”) (G-C036, SRT, “Measurement Method”) = (125206, DCM, “Cube Method”)

		“Cube Method”)
MM/EF(Cube) Alias: EF(Cube)	(18043-0, LN, “Left Ventricular Ejection Fraction”)	(G-0373, SRT, “Image Mode”) = (G-0394, SRT, “M mode”) (G-C036, SRT, “Measurement Method”) = (125206, DCM, “Cube Method”)
MM/SV(Cube) Alias: SV(Cube)	(F-32120, SRT, “Stroke Volume”)	(G-C0E3, SRT, “Finding Site”) = (T-32600, SRT, “Left Ventricle”) (G-0373, SRT, “Image Mode”) = (G-0394, SRT, “M mode”) (G-C036, SRT, “Measurement Method”) = (125206, DCM, “Cube Method”)
MM/SI(Cube) Alias: SI(Cube)	(F-00078, SRT, “Stroke Index”)	(G-C0E3, SRT, “Finding Site”) = (T-32600, SRT, “Left Ventricle”) (G-0373, SRT, “Image Mode”) = (G-0394, SRT, “M mode”) (G-C036, SRT, “Measurement Method”) = (125206, DCM, “Cube Method”)
MM/CO(Cube) Alias: CO(Cube)	(F-32100, SRT, “Cardiac Output”)	(G-C0E3, SRT, “Finding Site”) = (T-32600, SRT, “Left Ventricle”) (G-0373, SRT, “Image Mode”) = (G-0394, SRT, “M mode”) (G-C036, SRT, “Measurement Method”) = (125206, DCM, “Cube Method”)
MM/CI(Cube) Alias: CI(Cube)	(F-32110, SRT, “Cardiac Index”)	(G-C0E3, SRT, “Finding Site”) = (T-32600, SRT, “Left Ventricle”) (G-0373, SRT, “Image Mode”) = (G-0394, SRT, “M mode”) (G-C036, SRT, “Measurement Method”) = (125206, DCM, “Cube Method”)
MM/%FS Alias: %FS	(18051-3, LN, “Left Ventricular Fractional Shortening”)	(G-0373, SRT, «Image Mode») = (G-0394, SRT, «M mode»)
MM/IVSd/LVPWd Alias: IVSd/LVPWd	(18155-2, LN, “Interventricular Septum to Posterior Wall Thickness Ratio”)	(G-0373, SRT, “Image Mode”) = (G-0394, SRT, “M mode”) (R-4089A, SRT, “Cardiac Cycle Point”) = (F-32010, SRT, “Diastole”)

MM/%LVPW Thck Alias: %LVPW Thck	(18053-9, LN, "Left Ventricle Posterior Wall % Thickening")	(G-0373, SRT, «Image Mode») = (G-0394, SRT, «M mode»)
MM/LVd Mass Alias: LVd Mass	(18087-7, LN, "Left Ventricle Mass")	(G-0373, SRT, "Image Mode") = (G-0394, SRT, "M mode") (R-4089A, SRT, "Cardiac Cycle Point") = (F-32010, SRT, "Diastole")
MM/LVs Mass Alias: LVs Mass	(18087-7, LN, "Left Ventricle Mass")	(G-0373, SRT, "Image Mode") = (G-0394, SRT, "M mode") (R-4089A, SRT, "Cardiac Cycle Point") = (F-32020, SRT, "Systole")
MM/LVd Mass/ASE Alias: LVd Mass (ASE)	(18087-7, LN, "Left Ventricle Mass")	(G-0373, SRT, "Image Mode") = (G-0394, SRT, "M mode") (R-4089A, SRT, "Cardiac Cycle Point") = (F-32010, SRT, "Diastole") (G-C036, SRT, "Measurement Method") = (125221, DCM, "Left Ventricle Mass by M-mode")
MM/LVs Mass/ASE Alias: LVs Mass (ASE)	(18087-7, LN, "Left Ventricle Mass")	(G-0373, SRT, "Image Mode") = (G-0394, SRT, "M mode") (R-4089A, SRT, "Cardiac Cycle Point") = (F-32020, SRT, "Systole") (G-C036, SRT, "Measurement Method") = (125221, DCM, "Left Ventricle Mass by M-mode")
MM/LVPEP Alias: LVPEP	(18068-7, LN, "Left Ventricle Pre Ejection Period")	(G-0373, SRT, "Image Mode") = (G-0394, SRT, "M mode")
MM/LVPEP/ET Ratio Alias: LVPEP ET Ratio	(59088-5, LN, "Left Ventricular Pre-ejection time/Ejection time")	(G-0373, SRT, "Image Mode") = (G-0394, SRT, "M mode")
MM/LVET Alias: LVET	(20222-6, LN, "Ejection Time")	(G-0373, SRT, "Image Mode") = (G-0394, SRT, "M mode")
MM/Vcf Mean Alias: Vcf Mean	(59117-2, LN, "Mean Velocity of Circumferential Fibe Shortening (Mean VcFv)")	(G-0373, SRT, "Image Mode") = (G-0394, SRT, "M mode")
MM/Vcf Mean (corr) Alias: Vcf Mean (corr)	(59118-0, LN, "HR-Corrected Mean Velocity of Circumferential Fiber")	(G-0373, SRT, "Image Mode") = (G-0394, SRT, "M mode")

	Shortening”)	
MM/HeartRate Alias: HR	(8867-4, LN, “Heart rate”)	(G-0373, SRT, «Image Mode») = (G-0394, SRT, «M mode»)
SD/HeartRate Alias: HR	(8867-4, LN, “Heart rate”)	(G-0373, SRT, «Image Mode») = (R-409E4, SRT, «Doppler Pulsed»)
SD/HeartRate/Calc Alias: HR	(8867-4, LN, “Heart rate”)	(G-0373, SRT, «Image Mode») = (R-409E4, SRT, «Doppler Pulsed»)
IVCT Alias: IVCT	(G-037E, SRT, “Left Ventricular Isovolumic Contraction Time”)	
IVRT Alias: IVRT	(18071-1, LN, “Left Ventricular Isovolumic Relaxation Time”)	
MP/LVOT Diam Alias: LVOT Diam	(G-038F, SRT, “Cardiovascular Orifice Diameter”)	(G-C0E3, SRT, “Finding Site”) = (T-32650, SRT, “Left Ventricle Outflow Tract”)
MP/LVOT VTI Alias: LVOT VTI	(20354-7, LN, “Velocity Time Integral”)	(G-C0E3, SRT, “Finding Site”) = (T-32650, SRT, “Left Ventricle Outflow Tract”)
LVOT Vmax Alias: LVOT Vmax	(11726-7, LN, “Peak Velocity”)	(G-C0E3, SRT, “Finding Site”) = (T-32650, SRT, “Left Ventricle Outflow Tract”)
LVOT Vmax P Alias: LVOT Vmax	(11726-7, LN, “Peak Velocity”)	(G-C0E3, SRT, “Finding Site”) = (T-32650, SRT, “Left Ventricle Outflow Tract”)
LVOT maxPG Alias: LVOT maxPG	(20247-3, LN, “Peak Gradient”)	(G-C0E3, SRT, “Finding Site”) = (T-32650, SRT, “Left Ventricle Outflow Tract”)
LVOT Vmean Alias: LVOT Vmean	(20352-1, LN, “Mean Velocity”)	(G-C0E3, SRT, “Finding Site”) = (T-32650, SRT, “Left Ventricle Outflow Tract”)
LVOT meanPG Alias: LVOT meanPG	(20256-4, LN, “Mean Gradient”)	(G-C0E3, SRT, “Finding Site”) = (T-32650, SRT, “Left Ventricle Outflow Tract”)

<p>LVOT VTI Alias: LVOT VTI</p>	<p>(20354-7, LN, "Velocity Time Integral")</p>	<p>(G-C0E3, SRT, "Finding Site") = (T-32650, SRT, "Left Ventricle Outflow Tract")</p>
<p>LVOT HR Alias: HR</p>	<p>(8867-4, LN, "Heart rate")</p>	
<p>LVOT SV Alias: LVSV Dopp</p>	<p>(F-32120, SRT, "Stroke Volume")</p>	<p>(G-C0E3, SRT, "Finding Site") = (T-32650, SRT, "Left Ventricle Outflow Tract")</p>
<p>LVOT SI Alias: LVSI Dopp</p>	<p>(F-00078, SRT, "Stroke Index")</p>	<p>(G-C0E3, SRT, "Finding Site") = (T-32650, SRT, "Left Ventricle Outflow Tract")</p>
<p>LVOT CO Alias: LVCO Dopp</p>	<p>(F-32100, SRT, "Cardiac Output")</p>	<p>(G-C0E3, SRT, "Finding Site") = (T-32650, SRT, "Left Ventricle Outflow Tract")</p>
<p>LVOT CI Alias: LVCI Dopp</p>	<p>(F-32110, SRT, "Cardiac Index")</p>	<p>(G-C0E3, SRT, "Finding Site") = (T-32650, SRT, "Left Ventricle Outflow Tract")</p>
<p>LVOT Env. Ti Alias: LVOT Env. Ti</p>	<p>(GEU-106-0081, 99GEMS, "Tie duration of the VTI trace on LVOT")</p>	<p>(G-0373, SRT, "Image Mode") = (R-409E4, SRT, "Doppler Pulsed")</p>
<p>LIMP Alias: LIMP</p>	<p>(G-037F, SRT, "Left Ventricular Index of Myocardial Performance")</p>	<p>(G-C0E3, SRT, "Finding Site") = (T-32600, SRT, "Left Ventricle") (G-0373, SRT, "Image Mode") = (R-409E4, SRT, "Doppler Pulsed")</p>
<p>LVPEP Alias: LVPEP</p>	<p>(79989-0, LN, "Left Ventricle Pre Ejection Period by US doppler")</p>	<p>(G-0373, SRT, "Image Mode") = (R-409E4, SRT, "Doppler Pulsed") (G-C0E3, SRT, "Finding Site") = (T-32650, SRT, "Left Ventricle Outflow Tract")</p>
<p>LVET Alias: Ejection Time</p>	<p>(20222-6, LN, "Ejection Time")</p>	<p>(G-0373, SRT, "Image Mode") = (R-409E4, SRT, "Doppler Pulsed") (G-C0E3, SRT, "Finding Site") = (T-32650, SRT, "Left Ventricle Outflow Tract")</p>

		Outflow Tract")
<p>LVPEP/ET Ratio Alias: LVPEP/ET Ratio</p>	<p>(59088-5, LN, "Ventricular Pre ejection time/ Ejection time by US")</p>	<p>(G-0373, SRT, "Image Mode") = (R-409E4, SRT, "Doppler Pulsed") (G-C0E3, SRT, "Finding Site") = (T-32650, SRT, "Left Ventricle Outflow Tract")</p>
<p>AP/LVOT Diam Alias: LVOT Diam</p>	<p>(G-038F, SRT, "Cardiovascular Orifice Diameter")</p>	<p>(G-C0E3, SRT, "Finding Site") = (T-32650, SRT, "Left Ventricle Outflow Tract")</p>
<p>AP/LVOT VTI Alias: LVOT VTI</p>	<p>(20354-7, LN, "Velocity Time Integral")</p>	<p>(G-C0E3, SRT, "Finding Site") = (T-32650, SRT, "Left Ventricle Outflow Tract")</p>
<p>LVAd(avg) Alias: LVAd(avg)</p>	<p>(G-0375, SRT, "Left Ventricular Diastolic Area")</p>	<p>(G-C036, SRT, "Measurement Method") = (GEU-106-0017, 99GEMS, "Triplane")</p>
<p>LVAs(avg) Alias: LVAs(avg)</p>	<p>(G-0374, SRT, "Left Ventricular Systolic Area")</p>	<p>(G-C036, SRT, "Measurement Method") = (GEU-106-0017, 99GEMS, "Triplane")</p>
<p>ECG/HeartRate Alias: HR</p>	<p>(8867-4, LN, "Heart rate")</p>	
<p>LVEDV(4D) Alias: EDV</p>	<p>(18026-5, LN, "Left Ventricular End Diastolic Volume")</p>	<p>(G-0373, SRT, "Image Mode") = (125231, DCM, "3D mode") (G-C036, SRT, "Measurement Method") = (GEU-106-0023, 99GEMS, "4D Auto Left Ventricle Quantification")</p>
<p>LVESV(4D) Alias: ESV</p>	<p>(18148-7, LN, "Left Ventricular End Systolic Volume")</p>	<p>(G-0373, SRT, "Image Mode") = (125231, DCM, "3D mode") (G-C036, SRT, "Measurement Method") = (GEU-106-0023, 99GEMS, "4D Auto Left Ventricle Quantification")</p>
<p>EF(4D) Alias: EF</p>	<p>(18043-0, LN, "Left Ventricular Ejection Fraction")</p>	<p>(G-0373, SRT, "Image Mode") = (125231, DCM, "3D mode") (G-C036, SRT, "Measurement Method") = (GEU-106-0023, 99GEMS, "4D Auto Left</p>

		Ventricle Quantification”)
SV(4D) Alias: SV	(F-32120, SRT, “Stroke Volume”)	(G-0373, SRT, “Image Mode”) = (125231, DCM, “3D mode”) (G-C036, SRT, “Measurement Method”) = (GEU-106-0023, 99GEMS, “4D Auto Left Ventricle Quantification”)
CO(4D) Alias: CO	(F-32100, SRT, “Cardiac Output”)	(G-0373, SRT, “Image Mode”) = (125231, DCM, “3D mode”) (G-C036, SRT, “Measurement Method”) = (GEU-106-0023, 99GEMS, “4D Auto Left Ventricle Quantification”)
AWMA/GpeakSysSL(A2C) Alias: G peak SL(A2C)	(GEU-106-0001, 99GEMS, “Global Peak Longitudinal Strain”)	(111031, DCM, “Image View”) = (G-A19B, SRT, “Apical two chamber”) (G-C036, SRT, “Measurement Method”) = (GEU-106-0018, 99GEMS, “AFI”)
AWMA/GpeakSysSL(A4C) Alias: G peak SL(A4C)	(GEU-106-0001, 99GEMS, “Global Peak Longitudinal Strain”)	(111031, DCM, “Image View”) = (G-A19C, SRT, “Apical four chamber”) (G-C036, SRT, “Measurement Method”) = (GEU-106-0018, 99GEMS, “AFI”)
AWMA/GpeakSysSL(APLAX) Alias: G peak SL(APLAX)	(GEU-106-0001, 99GEMS, “Global Peak Longitudinal Strain”)	(111031, DCM, “Image View”) = (G-0395, SRT, “Apical long axis”) (G-C036, SRT, “Measurement Method”) = (GEU-106-0018, 99GEMS, “AFI”)
AWMA/GpeakSysSL(Avg) Alias: G peak SL(Avg)	(GEU-106-0001, 99GEMS, “Global Peak Longitudinal Strain”)	(G-C036, SRT, “Measurement Method”) = (GEU-106-0018, 99GEMS, “AFI”)
AWMA/AVC Alias: AVC	(GEU-106-0003, 99GEMS, “Aortic Valve Closure”)	(G-C036, SRT, “Measurement Method”) = (GEU-106-0018, 99GEMS, “AFI”)
AWMA/BS PeakSysSL Alias: BS peak sys SL	(GEU-106-0002, 99GEMS, “Peak Longitudinal Strain”)	(G-C0E3, SRT, “Finding Site”) = (R-10076, SRT, “left ventricle basal inferoseptal segment”) (R-4089A, SRT, “Cardiac Cycle Point”) = (F-32020, SRT, “Systole”)

		(G-C036, SRT, "Measurement Method") = (GEU-106-0018, 99GEMS, "AFI")
AWMA/MS PeakSysSL Alias: MS peak sys SL	(GEU-106-0002, 99GEMS, "Peak Longitudinal Strain")	(G-C0E3, SRT, "Finding Site") = (R-10078, SRT, "left ventricle mid inferoseptal segment") (R-4089A, SRT, "Cardiac Cycle Point") = (F-32020, SRT, "Systole") (G-C036, SRT, "Measurement Method") = (GEU-106-0018, 99GEMS, "AFI")
AWMA/AS PeakSysSL Alias: AS peak sys SL	(GEU-106-0002, 99GEMS, "Peak Longitudinal Strain")	(G-C0E3, SRT, "Finding Site") = (T-32614, SRT, "left ventricle apical septal segment") (R-4089A, SRT, "Cardiac Cycle Point") = (F-32020, SRT, "Systole") (G-C036, SRT, "Measurement Method") = (GEU-106-0018, 99GEMS, "AFI")
AWMA/BL PeakSysSL Alias: BL peak sys SL	(GEU-106-0002, 99GEMS, "Peak Longitudinal Strain")	(G-C0E3, SRT, "Finding Site") = (R-1007A, SRT, "left ventricle basal anterolateral segment") (R-4089A, SRT, "Cardiac Cycle Point") = (F-32020, SRT, "Systole") (G-C036, SRT, "Measurement Method") = (GEU-106-0018, 99GEMS, "AFI")
AWMA/ML PeakSysSL Alias: ML peak sys SL	(GEU-106-0002, 99GEMS, "Peak Longitudinal Strain")	(G-C0E3, SRT, "Finding Site") = (R-1007C, SRT, "left ventricle mid anterolateral segment") (R-4089A, SRT, "Cardiac Cycle Point") = (F-32020, SRT, "Systole") (G-C036, SRT, "Measurement Method") = (GEU-106-0018, 99GEMS, "AFI")
AWMA/AL PeakSysSL Alias: AL peak sys SL	(GEU-106-0002, 99GEMS, "Peak Longitudinal Strain")	(G-C0E3, SRT, "Finding Site") = (T-3261C, SRT, "left ventricle apical lateral segment") (R-4089A, SRT, "Cardiac Cycle Point") = (F-32020, SRT, "Systole") (G-C036, SRT, "Measurement Method") = (GEU-106-0018, 99GEMS, "AFI")

		99GEMS, "AFI")
<p>AWMA/BI PeakSysSL</p> <p>Alias: BI peak sys SL</p>	<p>(GEU-106-0002, 99GEMS, "Peak Longitudinal Strain")</p>	<p>(G-C0E3, SRT, "Finding Site") = (T-32615, SRT, "left ventricle basal inferior segment")</p> <p>(R-4089A, SRT, "Cardiac Cycle Point") = (F-32020, SRT, "Systole")</p> <p>(G-C036, SRT, "Measurement Method") = (GEU-106-0018, 99GEMS, "AFI")</p>
<p>AWMA/MI PeakSysSL</p> <p>Alias: MI peak sys SL</p>	<p>(GEU-106-0002, 99GEMS, "Peak Longitudinal Strain")</p>	<p>(G-C0E3, SRT, "Finding Site") = (T-32616, SRT, "left ventricle mid inferior segment")</p> <p>(R-4089A, SRT, "Cardiac Cycle Point") = (F-32020, SRT, "Systole")</p> <p>(G-C036, SRT, "Measurement Method") = (GEU-106-0018, 99GEMS, "AFI")</p>
<p>AWMA/AI PeakSysSL</p> <p>Alias: AI peak sys SL</p>	<p>(GEU-106-0002, 99GEMS, "Peak Longitudinal Strain")</p>	<p>(G-C0E3, SRT, "Finding Site") = (T-32618, SRT, "left ventricle apical inferior segment")</p> <p>(R-4089A, SRT, "Cardiac Cycle Point") = (F-32020, SRT, "Systole")</p> <p>(G-C036, SRT, "Measurement Method") = (GEU-106-0018, 99GEMS, "AFI")</p>
<p>AWMA/BA PeakSysSL</p> <p>Alias: BA peak sys SL</p>	<p>(GEU-106-0002, 99GEMS, "Peak Longitudinal Strain")</p>	<p>(G-C0E3, SRT, "Finding Site") = (T-32619, SRT, "left ventricle basal anterior segment")</p> <p>(R-4089A, SRT, "Cardiac Cycle Point") = (F-32020, SRT, "Systole")</p> <p>(G-C036, SRT, "Measurement Method") = (GEU-106-0018, 99GEMS, "AFI")</p>
<p>AWMA/MA PeakSysSL</p> <p>Alias: MA peak sys SL</p>	<p>(GEU-106-0002, 99GEMS, "Peak Longitudinal Strain")</p>	<p>(G-C0E3, SRT, "Finding Site") = (T-32617, SRT, "left ventricle mid anterior segment")</p> <p>(R-4089A, SRT, "Cardiac Cycle Point") = (F-32020, SRT, "Systole")</p> <p>(G-C036, SRT, "Measurement Method") = (GEU-106-0018, 99GEMS, "AFI")</p>

<p>AWMA/AA PeakSysSL Alias: AA peak sys SL</p>	<p>(GEU-106-0002, 99GEMS, “Peak Longitudinal Strain”)</p>	<p>(G-C0E3, SRT, “Finding Site”) = (T-32613, SRT, “left ventricle apical anterior segment”) (R-4089A, SRT, “Cardiac Cycle Point”) = (F-32020, SRT, “Systole”) (G-C036, SRT, “Measurement Method”) = (GEU-106-0018, 99GEMS, “AFI”)</p>
<p>AWMA/BP PeakSysSL Alias: BP peak sys SL</p>	<p>(GEU-106-0002, 99GEMS, “Peak Longitudinal Strain”)</p>	<p>(G-C0E3, SRT, “Finding Site”) = (R-10079, SRT, “left ventricle basal inferolateral segment”) (R-4089A, SRT, “Cardiac Cycle Point”) = (F-32020, SRT, “Systole”) (G-C036, SRT, “Measurement Method”) = (GEU-106-0018, 99GEMS, “AFI”)</p>
<p>AWMA/MP PeakSysSL Alias: MP peak sys SL</p>	<p>(GEU-106-0002, 99GEMS, “Peak Longitudinal Strain”)</p>	<p>(G-C0E3, SRT, “Finding Site”) = (R-1007B, SRT, “left ventricle mid inferolateral segment”) (R-4089A, SRT, “Cardiac Cycle Point”) = (F-32020, SRT, “Systole”) (G-C036, SRT, “Measurement Method”) = (GEU-106-0018, 99GEMS, “AFI”)</p>
<p>AWMA/AP PeakSysSL Alias: AP peak sys SL</p>	<p>(GEU-106-0002, 99GEMS, “Peak Longitudinal Strain”)</p>	<p>(G-C0E3, SRT, “Finding Site”) = (GEU-106-0025, 99GEMS, “left ventricle apical posterior segment”) (R-4089A, SRT, “Cardiac Cycle Point”) = (F-32020, SRT, “Systole”) (G-C036, SRT, “Measurement Method”) = (GEU-106-0018, 99GEMS, “AFI”)</p>
<p>AWMA/BAS PeakSysSL Alias: BAS peak sys SL</p>	<p>(GEU-106-0002, 99GEMS, “Peak Longitudinal Strain”)</p>	<p>(G-C0E3, SRT, “Finding Site”) = (R-10075, SRT, “left ventricle basal anteroseptal segment”) (R-4089A, SRT, “Cardiac Cycle Point”) = (F-32020, SRT, “Systole”) (G-C036, SRT, “Measurement Method”) = (GEU-106-0018, 99GEMS, “AFI”)</p>

<p>AWMA/MAS PeakSysSL Alias: MAS peak sys SL</p>	<p>(GEU-106-0002, 99GEMS, "Peak Longitudinal Strain")</p>	<p>(G-C0E3, SRT, "Finding Site") = (R-10077, SRT, "left ventricle mid anteroseptal segment") (R-4089A, SRT, "Cardiac Cycle Point") = (F-32020, SRT, "Systole") (G-C036, SRT, "Measurement Method") = (GEU-106-0018, 99GEMS, "AFI")</p>
<p>AWMA/AAS PeakSysSL Alias: AAS peak sys SL</p>	<p>(GEU-106-0002, 99GEMS, "Peak Longitudinal Strain")</p>	<p>(G-C0E3, SRT, "Finding Site") = (GEU-106-0026, 99GEMS, "left ventricle apical anteroseptal segment") (R-4089A, SRT, "Cardiac Cycle Point") = (F-32020, SRT, "Systole") (G-C036, SRT, "Measurement Method") = (GEU-106-0018, 99GEMS, "AFI")</p>
<p>AFI/BA PeakSysSL_ASE18 Alias: BA PeakSysSL ASE</p>	<p>(GEU-106-0002, 99GEMS, "Peak Longitudinal Strain")</p>	<p>(R-4089A, SRT, "Cardiac Cycle Point") = (F-32020, SRT, "Systole") (G-C0E3, SRT, "Finding Site") = (T-32619, SRT, "left ventricle basal anterior segment") (G-C036, SRT, "Measurement Method") = (GEU-106-0128, 99GEMS, "AFI with 18 segments following 2015 ASE recommendations")</p>
<p>AFI/BAS PeakSysSL_ASE18 Alias: BAS PeakSysSL ASE</p>	<p>(GEU-106-0002, 99GEMS, "Peak Longitudinal Strain")</p>	<p>(R-4089A, SRT, "Cardiac Cycle Point") = (F-32020, SRT, "Systole") (G-C0E3, SRT, "Finding Site") = (R-10075, SRT, "left ventricle basal anteroseptal segment") (G-C036, SRT, "Measurement Method") = (GEU-106-0128, 99GEMS, "AFI with 18 segments following 2015 ASE recommendations")</p>
<p>AFI/BIS PeakSysSL_ASE18</p>	<p>(GEU-106-0002, 99GEMS, "Peak Longitudinal Strain")</p>	<p>(R-4089A, SRT, "Cardiac Cycle Point") = (F-32020, SRT,</p>

<p>Alias: BIS PeakSysSL ASE</p>		<p>“Systole”)</p> <p>(G-C0E3, SRT, “Finding Site”) = (R-10076, SRT, “left ventricle basal inferoseptal segment”)</p> <p>(G-C036, SRT, “Measurement Method”) = (GEU-106-0128, 99GEMS, “AFI with 18 segments following 2015 ASE recommendations”)</p>
<p>AFI/BI PeakSysSL_ASE18</p> <p>Alias: BI PeakSysSL ASE</p>	<p>(GEU-106-0002, 99GEMS, “Peak Longitudinal Strain”)</p>	<p>(R-4089A, SRT, “Cardiac Cycle Point”) = (F-32020, SRT, “Systole”)</p> <p>(G-C0E3, SRT, “Finding Site”) = (T-32615, SRT, “left ventricle basal inferior segment”)</p> <p>(G-C036, SRT, “Measurement Method”) = (GEU-106-0128, 99GEMS, “AFI with 18 segments following 2015 ASE recommendations”)</p>
<p>AFI/BIL PeakSysSL_ASE18</p> <p>Alias: BIL PeakSysSL ASE</p>	<p>(GEU-106-0002, 99GEMS, “Peak Longitudinal Strain”)</p>	<p>(R-4089A, SRT, “Cardiac Cycle Point”) = (F-32020, SRT, “Systole”)</p> <p>(G-C0E3, SRT, “Finding Site”) = (R-10079, SRT, “left ventricle basal inferolateral segment”)</p> <p>(G-C036, SRT, “Measurement Method”) = (GEU-106-0128, 99GEMS, “AFI with 18 segments following 2015 ASE recommendations”)</p>
<p>AFI/BAL PeakSysSL_ASE18</p> <p>Alias: BAL PeakSysSL ASE</p>	<p>(GEU-106-0002, 99GEMS, “Peak Longitudinal Strain”)</p>	<p>(R-4089A, SRT, “Cardiac Cycle Point”) = (F-32020, SRT, “Systole”)</p> <p>(G-C0E3, SRT, “Finding Site”) = (R-1007A, SRT, “left ventricle basal anterolateral segment”)</p> <p>(G-C036, SRT, “Measurement Method”) = (GEU-106-0128, 99GEMS, “AFI with 18 segments following 2015 ASE</p>

		recommendations”)
<p>AFI/MA PeakSysSL_ASE18 Alias: MA PeakSysSL ASE</p>	<p>(GEU-106-0002, 99GEMS, “Peak Longitudinal Strain”)</p>	<p>(R-4089A, SRT, “Cardiac Cycle Point”) = (F-32020, SRT, “Systole”)</p> <p>(G-C0E3, SRT, “Finding Site”) = (T-32617, SRT, “left ventricle mid anterior segment”)</p> <p>(G-C036, SRT, “Measurement Method”) = (GEU-106-0128, 99GEMS, “AFI with 18 segments following 2015 ASE recommendations”)</p>
<p>AFI/MAS PeakSysSL_ASE18 Alias: MAS PeakSysSL ASE</p>	<p>(GEU-106-0002, 99GEMS, “Peak Longitudinal Strain”)</p>	<p>(R-4089A, SRT, “Cardiac Cycle Point”) = (F-32020, SRT, “Systole”)</p> <p>(G-C0E3, SRT, “Finding Site”) = (R-10077, SRT, “left ventricle mid anteroseptal segment”)</p> <p>(G-C036, SRT, “Measurement Method”) = (GEU-106-0128, 99GEMS, “AFI with 18 segments following 2015 ASE recommendations”)</p>
<p>AFI/MIS PeakSysSL_ASE18 Alias: MIS PeakSysSL ASE</p>	<p>(GEU-106-0002, 99GEMS, “Peak Longitudinal Strain”)</p>	<p>(R-4089A, SRT, “Cardiac Cycle Point”) = (F-32020, SRT, “Systole”)</p> <p>(G-C0E3, SRT, “Finding Site”) = (R-10078, SRT, “left ventricle mid inferoseptal segment”)</p> <p>(G-C036, SRT, “Measurement Method”) = (GEU-106-0128, 99GEMS, “AFI with 18 segments following 2015 ASE recommendations”)</p>
<p>AFI/MI PeakSysSL_ASE18 Alias: MI PeakSysSL ASE</p>	<p>(GEU-106-0002, 99GEMS, “Peak Longitudinal Strain”)</p>	<p>(R-4089A, SRT, “Cardiac Cycle Point”) = (F-32020, SRT, “Systole”)</p> <p>(G-C0E3, SRT, “Finding Site”) = (T-32616, SRT, “left ventricle mid inferior segment”)</p>

		(G-C036, SRT, "Measurement Method") = (GEU-106-0128, 99GEMS, "AFI with 18 segments following 2015 ASE recommendations")
AFI/MIL PeakSysSL_ASE18 Alias: MIL PeakSysSL ASE	(GEU-106-0002, 99GEMS, "Peak Longitudinal Strain")	(R-4089A, SRT, "Cardiac Cycle Point") = (F-32020, SRT, "Systole") (G-C0E3, SRT, "Finding Site") = (R-1007B, SRT, "left ventricle mid inferolateral segment") (G-C036, SRT, "Measurement Method") = (GEU-106-0128, 99GEMS, "AFI with 18 segments following 2015 ASE recommendations")
AFI/MAL PeakSysSL_ASE18 Alias: MAL PeakSysSL ASE	(GEU-106-0002, 99GEMS, "Peak Longitudinal Strain")	(R-4089A, SRT, "Cardiac Cycle Point") = (F-32020, SRT, "Systole") (G-C0E3, SRT, "Finding Site") = (R-1007C, SRT, "left ventricle mid anterolateral segment") (G-C036, SRT, "Measurement Method") = (GEU-106-0128, 99GEMS, "AFI with 18 segments following 2015 ASE recommendations")
AFI/AA PeakSysSL_ASE18 Alias: AA PeakSysSL ASE	(GEU-106-0002, 99GEMS, "Peak Longitudinal Strain")	(R-4089A, SRT, "Cardiac Cycle Point") = (F-32020, SRT, "Systole") (G-C0E3, SRT, "Finding Site") = (T-32613, SRT, "left ventricle apical anterior segment") (G-C036, SRT, "Measurement Method") = (GEU-106-0128, 99GEMS, "AFI with 18 segments following 2015 ASE recommendations")
AFI/AAS PeakSysSL_ASE18 Alias: AAS PeakSysSL ASE	(GEU-106-0002, 99GEMS, "Peak Longitudinal Strain")	(R-4089A, SRT, "Cardiac Cycle Point") = (F-32020, SRT, "Systole")

		<p>(G-C0E3, SRT, “Finding Site”) = (GEU-106-0026, 99GEMS, “left ventricle apical anteroseptal segment”)</p> <p>(G-C036, SRT, “Measurement Method”) = (GEU-106-0128, 99GEMS, “AFI with 18 segments following 2015 ASE recommendations”)</p>
<p>AFI/AIS PeakSysSL_ASE18</p> <p>Alias: AIS PeakSysSL ASE</p>	<p>(GEU-106-0002, 99GEMS, “Peak Longitudinal Strain”)</p>	<p>(R-4089A, SRT, “Cardiac Cycle Point”) = (F-32020, SRT, “Systole”)</p> <p>(G-C0E3, SRT, “Finding Site”) = (GEU-106-0125, 99GEMS, “left ventricle apical inferoseptal segment”)</p> <p>(G-C036, SRT, “Measurement Method”) = (GEU-106-0128, 99GEMS, “AFI with 18 segments following 2015 ASE recommendations”)</p>
<p>AFI/AI PeakSysSL_ASE18</p> <p>Alias: AI PeakSysSL ASE</p>	<p>(GEU-106-0002, 99GEMS, “Peak Longitudinal Strain”)</p>	<p>(R-4089A, SRT, “Cardiac Cycle Point”) = (F-32020, SRT, “Systole”)</p> <p>(G-C0E3, SRT, “Finding Site”) = (T-32618, SRT, “left ventricle apical inferior segment”)</p> <p>(G-C036, SRT, “Measurement Method”) = (GEU-106-0128, 99GEMS, “AFI with 18 segments following 2015 ASE recommendations”)</p>
<p>AFI/AIL PeakSysSL_ASE18</p> <p>Alias: AIL PeakSysSL ASE</p>	<p>(GEU-106-0002, 99GEMS, “Peak Longitudinal Strain”)</p>	<p>(R-4089A, SRT, “Cardiac Cycle Point”) = (F-32020, SRT, “Systole”)</p> <p>(G-C0E3, SRT, “Finding Site”) = (GEU-106-0126, 99GEMS, “left ventricle apical inferolateral segment”)</p> <p>(G-C036, SRT, “Measurement Method”) = (GEU-106-0128, 99GEMS, “AFI with 18 segments following 2015 ASE recommendations”)</p>

		following 2015 ASE recommendations")
<p>AFI/AAL PeakSysSL_ASE18</p> <p>Alias: AAL PeakSysSL ASE</p>	<p>(GEU-106-0002, 99GEMS, "Peak Longitudinal Strain")</p>	<p>(R-4089A, SRT, "Cardiac Cycle Point") = (F-32020, SRT, "Systole")</p> <p>(G-C0E3, SRT, "Finding Site") = (GEU-106-0127, 99GEMS, "left ventricle apical anterolateral segment")</p> <p>(G-C036, SRT, "Measurement Method") = (GEU-106-0128, 99GEMS, "AFI with 18 segments following 2015 ASE recommendations")</p>
<p>AFI/BA PeakSysSL_Endo</p> <p>Alias: BA PeakSysSL Endo</p>	<p>(GEU-106-0002, 99GEMS, "Peak Longitudinal Strain")</p>	<p>(G-C036, SRT, "Measurement Method") = (GEU-106-0129, 99GEMS, "AFI on endocardium")</p> <p>(R-4089A, SRT, "Cardiac Cycle Point") = (F-32020, SRT, "Systole")</p> <p>(G-C0E3, SRT, "Finding Site") = (T-32619, SRT, "left ventricle basal anterior segment")</p>
<p>AFI/BAS PeakSysSL_Endo</p> <p>Alias: BAS PeakSysSL Endo</p>	<p>(GEU-106-0002, 99GEMS, "Peak Longitudinal Strain")</p>	<p>(G-C036, SRT, "Measurement Method") = (GEU-106-0129, 99GEMS, "AFI on endocardium")</p> <p>(R-4089A, SRT, "Cardiac Cycle Point") = (F-32020, SRT, "Systole")</p> <p>(G-C0E3, SRT, "Finding Site") = (R-10075, SRT, "left ventricle basal anteroseptal segment")</p>
<p>AFI/BS PeakSysSL_Endo</p> <p>Alias: BS PeakSysSL Endo</p>	<p>(GEU-106-0002, 99GEMS, "Peak Longitudinal Strain")</p>	<p>(G-C036, SRT, "Measurement Method") = (GEU-106-0129, 99GEMS, "AFI on endocardium")</p> <p>(R-4089A, SRT, "Cardiac Cycle Point") = (F-32020, SRT, "Systole")</p>

		<p>“Systole”)</p> <p>(G-C0E3, SRT, “Finding Site”) = (R-10076, SRT, “left ventricle basal inferoseptal segment”)</p>
<p>AFI/BI PeakSysSL_Endo</p> <p>Alias: BI PeakSysSL Endo</p>	<p>(GEU-106-0002, 99GEMS, “Peak Longitudinal Strain”)</p>	<p>(R-4089A, SRT, “Cardiac Cycle Point”) = (F-32020, SRT, “Systole”)</p> <p>(G-C036, SRT, “Measurement Method”) = (GEU-106-0129, 99GEMS, “AFI on endocardium”)</p> <p>(G-C0E3, SRT, “Finding Site”) = (T-32615, SRT, “left ventricle basal inferior segment”)</p>
<p>AFI/BP PeakSysSL_Endo</p> <p>Alias: BP PeakSysSL Endo</p>	<p>(GEU-106-0002, 99GEMS, “Peak Longitudinal Strain”)</p>	<p>(R-4089A, SRT, “Cardiac Cycle Point”) = (F-32020, SRT, “Systole”)</p> <p>(G-C036, SRT, “Measurement Method”) = (GEU-106-0129, 99GEMS, “AFI on endocardium”)</p> <p>(G-C0E3, SRT, “Finding Site”) = (R-10079, SRT, “left ventricle basal inferolateral segment”)</p>
<p>AFI/BL PeakSysSL_Endo</p> <p>Alias: BL PeakSysSL Endo</p>	<p>(GEU-106-0002, 99GEMS, “Peak Longitudinal Strain”)</p>	<p>(R-4089A, SRT, “Cardiac Cycle Point”) = (F-32020, SRT, “Systole”)</p> <p>(G-C036, SRT, “Measurement Method”) = (GEU-106-0129, 99GEMS, “AFI on endocardium”)</p> <p>(G-C0E3, SRT, “Finding Site”) = (R-1007A, SRT, “left ventricle basal anterolateral segment”)</p>
<p>AFI/MA PeakSysSL_Endo</p> <p>Alias: MA PeakSysSL Endo</p>	<p>(GEU-106-0002, 99GEMS, “Peak Longitudinal Strain”)</p>	<p>(R-4089A, SRT, “Cardiac Cycle Point”) = (F-32020, SRT, “Systole”)</p> <p>(G-C036, SRT, “Measurement Method”) = (GEU-106-0129, 99GEMS, “AFI on</p>

		<p>endocardium”)</p> <p>(G-C0E3, SRT, “Finding Site”) = (R-32617, SRT, “left ventricle mid anterior segment”)</p>
<p>AFI/MAS PeakSysSL_Endo</p> <p>Alias: MAS PeakSysSL Endo</p>	<p>(GEU-106-0002, 99GEMS, “Peak Longitudinal Strain”)</p>	<p>(R-4089A, SRT, “Cardiac Cycle Point”) = (F-32020, SRT, “Systole”)</p> <p>(G-C036, SRT, “Measurement Method”) = (GEU-106-0129, 99GEMS, “AFI on endocardium”)</p> <p>(G-C0E3, SRT, “Finding Site”) = (R-10077, SRT, “left ventricle mid anteroseptal segment”)</p>
<p>AFI/MS PeakSysSL_Endo</p> <p>Alias: MS PeakSysSL Endo</p>	<p>(GEU-106-0002, 99GEMS, “Peak Longitudinal Strain”)</p>	<p>(R-4089A, SRT, “Cardiac Cycle Point”) = (F-32020, SRT, “Systole”)</p> <p>(G-C036, SRT, “Measurement Method”) = (GEU-106-0129, 99GEMS, “AFI on endocardium”)</p> <p>(G-C0E3, SRT, “Finding Site”) = (R-10078, SRT, “left ventricle mid inferoseptal segment”)</p>
<p>AFI/MI PeakSysSL_Endo</p> <p>Alias: MI PeakSysSL Endo</p>	<p>(GEU-106-0002, 99GEMS, “Peak Longitudinal Strain”)</p>	<p>(R-4089A, SRT, “Cardiac Cycle Point”) = (F-32020, SRT, “Systole”)</p> <p>(G-C036, SRT, “Measurement Method”) = (GEU-106-0129, 99GEMS, “AFI on endocardium”)</p> <p>(G-C0E3, SRT, “Finding Site”) = (T-32616, SRT, “left ventricle mid inferior segment”)</p>
<p>AFI/MP PeakSysSL_Endo</p> <p>Alias: MP PeakSysSL Endo</p>	<p>(GEU-106-0002, 99GEMS, “Peak Longitudinal Strain”)</p>	<p>(R-4089A, SRT, “Cardiac Cycle Point”) = (F-32020, SRT, “Systole”)</p> <p>(G-C036, SRT, “Measurement Method”) = (GEU-106-0129, 99GEMS, “AFI on</p>

		<p>endocardium”)</p> <p>(G-C0E3, SRT, “Finding Site”) = (R-1007B, SRT, “left ventricle mid inferolateral segment”)</p>
<p>AFI/ML PeakSysSL_Endo</p> <p>Alias: ML PeakSysSL Endo</p>	<p>(GEU-106-0002, 99GEMS, “Peak Longitudinal Strain”)</p>	<p>(R-4089A, SRT, “Cardiac Cycle Point”) = (F-32020, SRT, “Systole”)</p> <p>(G-C036, SRT, “Measurement Method”) = (GEU-106-0129, 99GEMS, “AFI on endocardium”)</p> <p>(G-C0E3, SRT, “Finding Site”) = (R-1007C, SRT, “left ventricle mid anterolateral segment”)</p>
<p>AFI/AA PeakSysSL_Endo</p> <p>Alias: AA PeakSysSL Endo</p>	<p>(GEU-106-0002, 99GEMS, “Peak Longitudinal Strain”)</p>	<p>(R-4089A, SRT, “Cardiac Cycle Point”) = (F-32020, SRT, “Systole”)</p> <p>(G-C036, SRT, “Measurement Method”) = (GEU-106-0129, 99GEMS, “AFI on endocardium”)</p> <p>(G-C0E3, SRT, “Finding Site”) = (T-32613, SRT, “left ventricle apical anterior segment”)</p>
<p>AFI/AAS PeakSysSL_Endo</p> <p>Alias: AAS PeakSysSL Endo</p>	<p>(GEU-106-0002, 99GEMS, “Peak Longitudinal Strain”)</p>	<p>(R-4089A, SRT, “Cardiac Cycle Point”) = (F-32020, SRT, “Systole”)</p> <p>(G-C036, SRT, “Measurement Method”) = (GEU-106-0129, 99GEMS, “AFI on endocardium”)</p> <p>(G-C0E3, SRT, “Finding Site”) = (GEU-106-0026, 99GEMS, “left ventricle apical anteroseptal segment”)</p>
<p>AFI/AS PeakSysSL_Endo</p> <p>Alias: AS PeakSysSL Endo</p>	<p>(GEU-106-0002, 99GEMS, “Peak Longitudinal Strain”)</p>	<p>(R-4089A, SRT, “Cardiac Cycle Point”) = (F-32020, SRT, “Systole”)</p> <p>(G-C036, SRT, “Measurement Method”) = (GEU-106-0129,</p>

		<p>99GEMS, “AFI on endocardium”)</p> <p>(G-C0E3, SRT, “Finding Site”) = (T-32614, SRT, “left ventricle apical septal segment”)</p>
<p>AFI/AI PeakSysSL_Endo</p> <p>Alias: AI PeakSysSL Endo</p>	<p>(GEU-106-0002, 99GEMS, “Peak Longitudinal Strain”)</p>	<p>(R-4089A, SRT, “Cardiac Cycle Point”) = (F-32020, SRT, “Systole”)</p> <p>(G-C036, SRT, “Measurement Method”) = (GEU-106-0129, 99GEMS, “AFI on endocardium”)</p> <p>(G-C0E3, SRT, “Finding Site”) = (T-32618, SRT, “left ventricle apical inferior segment”)</p>
<p>AFI/AP PeakSysSL_Endo</p> <p>Alias: AP PeakSysSL Endo</p>	<p>(GEU-106-0002, 99GEMS, “Peak Longitudinal Strain”)</p>	<p>(R-4089A, SRT, “Cardiac Cycle Point”) = (F-32020, SRT, “Systole”)</p> <p>(G-C036, SRT, “Measurement Method”) = (GEU-106-0129, 99GEMS, “AFI on endocardium”)</p> <p>(G-C0E3, SRT, “Finding Site”) = (GEU-106-0025, 99GEMS, “left ventricle apical posterior segment”)</p>
<p>AFI/AL PeakSysSL_Endo</p> <p>Alias: AL PeakSysSL Endo</p>	<p>(GEU-106-0002, 99GEMS, “Peak Longitudinal Strain”)</p>	<p>(R-4089A, SRT, “Cardiac Cycle Point”) = (F-32020, SRT, “Systole”)</p> <p>(G-C036, SRT, “Measurement Method”) = (GEU-106-0129, 99GEMS, “AFI on endocardium”)</p> <p>(G-C0E3, SRT, “Finding Site”) = (T-3261C, SRT, “left ventricle apical lateral segment”)</p>
<p>AFI/PSD_Endo_ASE18</p> <p>Alias: PSD Endo ASE18</p>	<p>(GEU-106-0131, 99GEMS, “Peak Strain Dispersion”)</p>	<p>(R-4089A, SRT, “Cardiac Cycle Point”) = (F-32020, SRT, “Systole”)</p> <p>(G-C036, SRT, “Measurement</p>

		Method”) = (GEU-106-0130, 99GEMS, “AFI on endocardium with 18 segments following 2015 ASE recommendations”)
AFI/BA PeakSysSL_Endo_ASE18 Alias: BA PeakSysSL Endo ASE18	(GEU-106-0002, 99GEMS, “Peak Longitudinal Strain”)	(R-4089A, SRT, “Cardiac Cycle Point”) = (F-32020, SRT, “Systole”) (G-C036, SRT, “Measurement Method”) = (GEU-106-0130, 99GEMS, “AFI on endocardium with 18 segments following 2015 ASE recommendations”) (G-C0E3, SRT, “Finding Site”) = (T-32619, SRT, “left ventricle basal anterior segment”)
AFI/BAS PeakSysSL_Endo_ASE18 Alias: BAS PeakSysSL Endo ASE18	(GEU-106-0002, 99GEMS, “Peak Longitudinal Strain”)	(R-4089A, SRT, “Cardiac Cycle Point”) = (F-32020, SRT, “Systole”) (G-C036, SRT, “Measurement Method”) = (GEU-106-0130, 99GEMS, “AFI on endocardium with 18 segments following 2015 ASE recommendations”) (G-C0E3, SRT, “Finding Site”) = (R-10075, SRT, “left ventricle basal anteroseptal segment”)
AFI/BIS PeakSysSL_Endo_ASE18 Alias: BIS PeakSysSL Endo ASE18	(GEU-106-0002, 99GEMS, “Peak Longitudinal Strain”)	(R-4089A, SRT, “Cardiac Cycle Point”) = (F-32020, SRT, “Systole”) (G-C036, SRT, “Measurement Method”) = (GEU-106-0130, 99GEMS, “AFI on endocardium with 18 segments following 2015 ASE recommendations”) (G-C0E3, SRT, “Finding Site”) = (R-10076, SRT, “left ventricle basal inferoseptal segment”)
AFI/BI PeakSysSL_Endo_ASE18 Alias: BI PeakSysSL Endo ASE18	(GEU-106-0002, 99GEMS, “Peak Longitudinal Strain”)	(R-4089A, SRT, “Cardiac Cycle Point”) = (F-32020, SRT, “Systole”) (G-C036, SRT, “Measurement

		<p>Method”) = (GEU-106-0130, 99GEMS, “AFI on endocardium with 18 segments following 2015 ASE recommendations”)</p> <p>(G-C0E3, SRT, “Finding Site”) = (T-32615, SRT, “left ventricle basal inferior segment”)</p>
<p>AFI/BIL PeakSysSL_Endo_ASE18</p> <p>Alias: BIL PeakSysSL Endo ASE18</p>	<p>(GEU-106-0002, 99GEMS, “Peak Longitudinal Strain”)</p>	<p>(R-4089A, SRT, “Cardiac Cycle Point”) = (F-32020, SRT, “Systole”)</p> <p>(G-C036, SRT, “Measurement Method”) = (GEU-106-0130, 99GEMS, “AFI on endocardium with 18 segments following 2015 ASE recommendations”)</p> <p>(G-C0E3, SRT, “Finding Site”) = (R-10079, SRT, “left ventricle basal inferolateral segment”)</p>
<p>AFI/BAL PeakSysSL_Endo_ASE18</p> <p>Alias: BAL PeakSysSL Endo ASE18</p>	<p>(GEU-106-0002, 99GEMS, “Peak Longitudinal Strain”)</p>	<p>(R-4089A, SRT, “Cardiac Cycle Point”) = (F-32020, SRT, “Systole”)</p> <p>(G-C036, SRT, “Measurement Method”) = (GEU-106-0130, 99GEMS, “AFI on endocardium with 18 segments following 2015 ASE recommendations”)</p> <p>(G-C0E3, SRT, “Finding Site”) = (R-1007A, SRT, “left ventricle basal anterolateral segment”)</p>
<p>AFI/MA PeakSysSL_Endo_ASE18</p> <p>Alias: MA PeakSysSL Endo ASE18</p>	<p>(GEU-106-0002, 99GEMS, “Peak Longitudinal Strain”)</p>	<p>(R-4089A, SRT, “Cardiac Cycle Point”) = (F-32020, SRT, “Systole”)</p> <p>(G-C036, SRT, “Measurement Method”) = (GEU-106-0130, 99GEMS, “AFI on endocardium with 18 segments following 2015 ASE recommendations”)</p> <p>(G-C0E3, SRT, “Finding Site”) = (T-32617, SRT, “left ventricle mid anterior segment”)</p>
<p>AFI/MAS</p>	<p>(GEU-106-0002, 99GEMS,</p>	<p>(R-4089A, SRT, “Cardiac Cycle</p>

<p>PeakSysSL_Endo_ASE18 Alias: MAS PeakSysSL Endo ASE18</p>	<p>“Peak Longitudinal Strain”)</p>	<p>Point”) = (F-32020, SRT, “Systole”) (G-C036, SRT, “Measurement Method”) = (GEU-106-0130, 99GEMS, “AFI on endocardium with 18 segments following 2015 ASE recommendations”) (G-C0E3, SRT, “Finding Site”) = (R-10077, SRT, “left ventricle mid anteroseptal segment”)</p>
<p>AFI/MIS PeakSysSL_Endo_ASE18 Alias: MIS PeakSysSL Endo ASE18</p>	<p>(GEU-106-0002, 99GEMS, “Peak Longitudinal Strain”)</p>	<p>(R-4089A, SRT, “Cardiac Cycle Point”) = (F-32020, SRT, “Systole”) (G-C036, SRT, “Measurement Method”) = (GEU-106-0130, 99GEMS, “AFI on endocardium with 18 segments following 2015 ASE recommendations”) (G-C0E3, SRT, “Finding Site”) = (R-10078, SRT, “left ventricle mid inferoseptal segment”)</p>
<p>AFI/MI PeakSysSL_Endo_ASE18 Alias: MI PeakSysSL Endo ASE18</p>	<p>(GEU-106-0002, 99GEMS, “Peak Longitudinal Strain”)</p>	<p>(R-4089A, SRT, “Cardiac Cycle Point”) = (F-32020, SRT, “Systole”) (G-C036, SRT, “Measurement Method”) = (GEU-106-0130, 99GEMS, “AFI on endocardium with 18 segments following 2015 ASE recommendations”) (G-C0E3, SRT, “Finding Site”) = (T-32616, SRT, “left ventricle mid inferior segment”)</p>
<p>AFI/MIL PeakSysSL_Endo_ASE18 Alias: MIL PeakSysSL Endo ASE18</p>	<p>(GEU-106-0002, 99GEMS, “Peak Longitudinal Strain”)</p>	<p>(R-4089A, SRT, “Cardiac Cycle Point”) = (F-32020, SRT, “Systole”) (G-C036, SRT, “Measurement Method”) = (GEU-106-0130, 99GEMS, “AFI on endocardium with 18 segments following 2015 ASE recommendations”) (G-C0E3, SRT, “Finding Site”) =</p>

		(R-1007B, SRT, “left ventricle mid inferolateral segment”)
<p>AFI/MAL PeakSysSL_Endo_ASE18 Alias: MAL PeakSysSL Endo ASE18</p>	<p>(GEU-106-0002, 99GEMS, “Peak Longitudinal Strain”)</p>	<p>(R-4089A, SRT, “Cardiac Cycle Point”) = (F-32020, SRT, “Systole”)</p> <p>(G-C036, SRT, “Measurement Method”) = (GEU-106-0130, 99GEMS, “AFI on endocardium with 18 segments following 2015 ASE recommendations”)</p> <p>(G-C0E3, SRT, “Finding Site”) = (R-1007C, SRT, “left ventricle mid anterolateral segment”)</p>
<p>AFI/AA PeakSysSL_Endo_ASE18 Alias: AA PeakSysSL Endo ASE18</p>	<p>(GEU-106-0002, 99GEMS, “Peak Longitudinal Strain”)</p>	<p>(R-4089A, SRT, “Cardiac Cycle Point”) = (F-32020, SRT, “Systole”)</p> <p>(G-C036, SRT, “Measurement Method”) = (GEU-106-0130, 99GEMS, “AFI on endocardium with 18 segments following 2015 ASE recommendations”)</p> <p>(G-C0E3, SRT, “Finding Site”) = (T-32613, SRT, “left ventricle apical anterior segment”)</p>
<p>AFI/AAS PeakSysSL_Endo_ASE18 Alias: AAS PeakSysSL Endo ASE18</p>	<p>(GEU-106-0002, 99GEMS, “Peak Longitudinal Strain”)</p>	<p>(R-4089A, SRT, “Cardiac Cycle Point”) = (F-32020, SRT, “Systole”)</p> <p>(G-C036, SRT, “Measurement Method”) = (GEU-106-0130, 99GEMS, “AFI on endocardium with 18 segments following 2015 ASE recommendations”)</p> <p>(G-C0E3, SRT, “Finding Site”) = (GEU-106-0026, 99GEMS, “left ventricle apical anteroseptal segment”)</p>
<p>AFI/AIS PeakSysSL_Endo_ASE18 Alias: AIS PeakSysSL Endo ASE18</p>	<p>(GEU-106-0002, 99GEMS, “Peak Longitudinal Strain”)</p>	<p>(R-4089A, SRT, “Cardiac Cycle Point”) = (F-32020, SRT, “Systole”)</p> <p>(G-C036, SRT, “Measurement Method”) = (GEU-106-0130,</p>

		<p>99GEMS, “AFI on endocardium with 18 segments following 2015 ASE recommendations”)</p> <p>(G-C0E3, SRT, “Finding Site”) = (GEU-106-0125, 99GEMS, “left ventricle apical inferoseptal segment”)</p>
<p>AFI/AI PeakSysSL_Endo_ASE18</p> <p>Alias: AI PeakSysSL Endo ASE18</p>	<p>(GEU-106-0002, 99GEMS, “Peak Longitudinal Strain”)</p>	<p>(R-4089A, SRT, “Cardiac Cycle Point”) = (F-32020, SRT, “Systole”)</p> <p>(G-C036, SRT, “Measurement Method”) = (GEU-106-0130, 99GEMS, “AFI on endocardium with 18 segments following 2015 ASE recommendations”)</p> <p>(G-C0E3, SRT, “Finding Site”) = (T-32618, SRT, “left ventricle apical inferior segment”)</p>
<p>AFI/AIL</p> <p>PeakSysSL_Endo_ASE18</p> <p>Alias: AIL PeakSysSL Endo ASE18</p>	<p>(GEU-106-0002, 99GEMS, “Peak Longitudinal Strain”)</p>	<p>(R-4089A, SRT, “Cardiac Cycle Point”) = (F-32020, SRT, “Systole”)</p> <p>(G-C036, SRT, “Measurement Method”) = (GEU-106-0130, 99GEMS, “AFI on endocardium with 18 segments following 2015 ASE recommendations”)</p> <p>(G-C0E3, SRT, “Finding Site”) = (GEU-106-0126, 99GEMS, “left ventricle apical inferolateral segment”)</p>
<p>AFI/AAL</p> <p>PeakSysSL_Endo_ASE18</p> <p>Alias: AAL PeakSysSL Endo ASE18</p>	<p>(GEU-106-0002, 99GEMS, “Peak Longitudinal Strain”)</p>	<p>(R-4089A, SRT, “Cardiac Cycle Point”) = (F-32020, SRT, “Systole”)</p> <p>(G-C036, SRT, “Measurement Method”) = (GEU-106-0130, 99GEMS, “AFI on endocardium with 18 segments following 2015 ASE recommendations”)</p> <p>(G-C0E3, SRT, “Finding Site”) = (GEU-106-0127, 99GEMS, “left ventricle apical anterolateral</p>

		segment”)
AFI/AVC Alias: AVC	(GEU-106-0003, 99GEMS, “Aortic Valve Closure”)	(G-C036, SRT, “Measurement Method”) = (GEU-106-0018, 99GEMS, “AFI”)
AFI/GPeakSysSL(APLAX) Alias: GpeakSysSL(APLAX)	(GEU-106-0001, 99GEMS, “Global Peak Longitudinal Strain”)	(G-C036, SRT, “Measurement Method”) = (GEU-106-0018, 99GEMS, “AFI”) (111031, DCM, “Image View”) = (G-0395, SRT, “Apical long axis”)
AFI/GpeakSysSL(A4C) Alias: GpeakSysSL(A4C)	(GEU-106-0001, 99GEMS, “Global Peak Longitudinal Strain”)	(G-C036, SRT, “Measurement Method”) = (GEU-106-0018, 99GEMS, “AFI”) (111031, DCM, “Image View”) = (G-A19C, SRT, “Apical four chamber”)
AFI/GpeakSysSL(A2C) Alias: GpeakSysSL(A2C)	(GEU-106-0001, 99GEMS, “Global Peak Longitudinal Strain”)	(G-C036, SRT, “Measurement Method”) = (GEU-106-0018, 99GEMS, “AFI”) (111031, DCM, “Image View”) = (G-A19B, SRT, “Apical two chamber”)
AFI/GpeakSysSL(Avg) Alias: GpeakSysSL(Avg)	(GEU-106-0001, 99GEMS, “Global Peak Longitudinal Strain”)	(G-C036, SRT, “Measurement Method”) = (GEU-106-0018, 99GEMS, “AFI”)
AFI/GPeakSysSL_Endo(A2C) Alias: GPeakSysSL Endo(A2C)	(GEU-106-0001, 99GEMS, “Global Peak Longitudinal Strain”)	(G-C036, SRT, “Measurement Method”) = (GEU-106-0129, 99GEMS, “AFI on Endocardium”) (111031, DCM, “Image View”) = (G-A19B, SRT, “Apical two chamber”)
AFI/GPeakSysSL_Endo(A4C) Alias: GPeakSysSL Endo(A4C)	(GEU-106-0001, 99GEMS, “Global Peak Longitudinal Strain”)	(G-C036, SRT, “Measurement Method”) = (GEU-106-0129, 99GEMS, “AFI on Endocardium”) (111031, DCM, “Image View”) = (G-A19C, SRT, “Apical four chamber”)

<p>AFI/GPeakSysSL_Endo(APLAX) Alias: GPeakSysSL Endo(APLAX)</p>	<p>(GEU-106-0001, 99GEMS, “Global Peak Longitudinal Strain”)</p>	<p>(G-C036, SRT, “Measurement Method”) = (GEU-106-0129, 99GEMS, “AFI on Endocardium”) (111031, DCM, “Image View”) = (G-0395, SRT, “Apical long axis”)</p>
<p>AFI/GPeakSysSL_Endo(Avg) Alias: GPeakSysSL Endo(Avg)</p>	<p>(GEU-106-0001, 99GEMS, “Global Peak Longitudinal Strain”)</p>	<p>(G-C036, SRT, “Measurement Method”) = (GEU-106-0129, 99GEMS, “AFI on Endocardium”)</p>
<p>AFI/PSD Alias: PSD</p>	<p>(GEU-106-0131, 99GEMS, “Peak Strain Dispersion”)</p>	<p>(R-4089A, SRT, “Cardiac Cycle Point”) = (F-32020, SRT, “Systole”) (G-C036, SRT, “Measurement Method”) = (GEU-106-0018, 99GEMS, “AFI”)</p>
<p>AFI/PSD_ASE18 Alias: PSD ASE18</p>	<p>(GEU-106-0131, 99GEMS, “Peak Strain Dispersion”)</p>	<p>(R-4089A, SRT, “Cardiac Cycle Point”) = (F-32020, SRT, “Systole”) (G-C036, SRT, “Measurement Method”) = (GEU-106-0128, 99GEMS, “AFI with 18 segments following 2015 ASE recommendations”)</p>
<p>AFI/PSD_ENDO Alias: PSD ENDO</p>	<p>(GEU-106-0131, 99GEMS, “Peak Strain Dispersion”)</p>	<p>(R-4089A, SRT, “Cardiac Cycle Point”) = (F-32020, SRT, “Systole”) (G-C036, SRT, “Measurement Method”) = (GEU-106-0129, 99GEMS, “AFI on endocardium”)</p>
<p>AFI/BA PeakSysSL Alias: BA PeakSysSL</p>	<p>(GEU-106-0002, 99GEMS, “Peak Longitudinal Strain”)</p>	<p>(G-C036, SRT, “Measurement Method”) = (GEU-106-0018, 99GEMS, “AFI”) (R-4089A, SRT, “Cardiac Cycle Point”) = (F-32020, SRT, “Systole”) (G-C0E3, SRT, “Finding Site”) = (T-32619, SRT, “left ventricle</p>

		basal anterior segment”)
<p>AFI/BAS PeakSysSL Alias: BAS PeakSysSL</p>	<p>(GEU-106-0002, 99GEMS, “Peak Longitudinal Strain”)</p>	<p>(G-C036, SRT, “Measurement Method”) = (GEU-106-0018, 99GEMS, “AFI”)</p> <p>(R-4089A, SRT, “Cardiac Cycle Point”) = (F-32020, SRT, “Systole”)</p> <p>(G-C0E3, SRT, “Finding Site”) = (R-10075, SRT, “left ventricle basal anteroseptal segment”)</p>
<p>AFI/BS PeakSysSL Alias: BS PeakSysSL</p>	<p>(GEU-106-0002, 99GEMS, “Peak Longitudinal Strain”)</p>	<p>(G-C036, SRT, “Measurement Method”) = (GEU-106-0018, 99GEMS, “AFI”)</p> <p>(R-4089A, SRT, “Cardiac Cycle Point”) = (F-32020, SRT, “Systole”)</p> <p>(G-C0E3, SRT, “Finding Site”) = (R-10076, SRT, “left ventricle basal inferoseptal segment”)</p>
<p>AFI/BI PeakSysSL Alias: BI PeakSysSL</p>	<p>(GEU-106-0002, 99GEMS, “Peak Longitudinal Strain”)</p>	<p>(G-C036, SRT, “Measurement Method”) = (GEU-106-0018, 99GEMS, “AFI”)</p> <p>(R-4089A, SRT, “Cardiac Cycle Point”) = (F-32020, SRT, “Systole”)</p> <p>(G-C0E3, SRT, “Finding Site”) = (T-32615, SRT, “left ventricle basal inferior segment”)</p>
<p>AFI/BP PeakSysSL Alias: BP PeakSysSL</p>	<p>(GEU-106-0002, 99GEMS, “Peak Longitudinal Strain”)</p>	<p>(G-C036, SRT, “Measurement Method”) = (GEU-106-0018, 99GEMS, “AFI”)</p> <p>(R-4089A, SRT, “Cardiac Cycle Point”) = (F-32020, SRT, “Systole”)</p> <p>(G-C0E3, SRT, “Finding Site”) = (R-10079, SRT, “left ventricle basal inferolateral segment”)</p>
<p>AFI/BL PeakSysSL</p>	<p>(GEU-106-0002, 99GEMS,</p>	<p>(G-C036, SRT, “Measurement</p>

<p>Alias: BL PeakSysSL</p>	<p>“Peak Longitudinal Strain”)</p>	<p>Method”) = (GEU-106-0018, 99GEMS, “AFI”) (R-4089A, SRT, “Cardiac Cycle Point”) = (F-32020, SRT, “Systole”) (G-C0E3, SRT, “Finding Site”) = (R-1007A, SRT, “left ventricle basal anterolateral segment”)</p>
<p>AFI/MA PeakSysSL Alias: MA PeakSysSL</p>	<p>(GEU-106-0002, 99GEMS, “Peak Longitudinal Strain”)</p>	<p>(G-C036, SRT, “Measurement Method”) = (GEU-106-0018, 99GEMS, “AFI”) (R-4089A, SRT, “Cardiac Cycle Point”) = (F-32020, SRT, “Systole”) (G-C0E3, SRT, “Finding Site”) = (T-32617, SRT, “left ventricle mid anterior segment”)</p>
<p>AFI/MAS PeakSysSL Alias: MAS PeakSysSL</p>	<p>(GEU-106-0002, 99GEMS, “Peak Longitudinal Strain”)</p>	<p>(G-C036, SRT, “Measurement Method”) = (GEU-106-0018, 99GEMS, “AFI”) (R-4089A, SRT, “Cardiac Cycle Point”) = (F-32020, SRT, “Systole”) (G-C0E3, SRT, “Finding Site”) = (R-10077, SRT, “left ventricle mid anteroseptal segment”)</p>
<p>AFI/MS PeakSysSL Alias: MS PeakSysSL</p>	<p>(GEU-106-0002, 99GEMS, “Peak Longitudinal Strain”)</p>	<p>(G-C036, SRT, “Measurement Method”) = (GEU-106-0018, 99GEMS, “AFI”) (R-4089A, SRT, “Cardiac Cycle Point”) = (F-32020, SRT, “Systole”) (G-C0E3, SRT, “Finding Site”) = (R-10078, SRT, “left ventricle mid inferoseptal segment”)</p>
<p>AFI/MI PeakSysSL Alias: MI PeakSysSL</p>	<p>(GEU-106-0002, 99GEMS, “Peak Longitudinal Strain”)</p>	<p>(G-C036, SRT, “Measurement Method”) = (GEU-106-0018, 99GEMS, “AFI”) (R-4089A, SRT, “Cardiac Cycle</p>

		<p>Point”) = (F-32020, SRT, “Systole”)</p> <p>(G-C0E3, SRT, “Finding Site”) = (T-32616, SRT, “left ventricle mid inferior segment”)</p>
<p>AFI/MP PeakSysSL</p> <p>Alias: MP PeakSysSL</p>	<p>(GEU-106-0002, 99GEMS, “Peak Longitudinal Strain”)</p>	<p>(G-C036, SRT, “Measurement Method”) = (GEU-106-0018, 99GEMS, “AFI”)</p> <p>(R-4089A, SRT, “Cardiac Cycle Point”) = (F-32020, SRT, “Systole”)</p> <p>(G-C0E3, SRT, “Finding Site”) = (R-1007B, SRT, “left ventricle mid inferolateral segment”)</p>
<p>AFI/ML PeakSysSL</p> <p>Alias: ML PeakSysSL</p>	<p>(GEU-106-0002, 99GEMS, “Peak Longitudinal Strain”)</p>	<p>(G-C036, SRT, “Measurement Method”) = (GEU-106-0018, 99GEMS, “AFI”)</p> <p>(R-4089A, SRT, “Cardiac Cycle Point”) = (F-32020, SRT, “Systole”)</p> <p>(G-C0E3, SRT, “Finding Site”) = (R-1007C, SRT, “left ventricle mid anterolateral segment”)</p>
<p>AFI/AA PeakSysSL</p> <p>Alias: AA PeakSysSL</p>	<p>(GEU-106-0002, 99GEMS, “Peak Longitudinal Strain”)</p>	<p>(G-C036, SRT, “Measurement Method”) = (GEU-106-0018, 99GEMS, “AFI”)</p> <p>(R-4089A, SRT, “Cardiac Cycle Point”) = (F-32020, SRT, “Systole”)</p> <p>(G-C0E3, SRT, “Finding Site”) = (T-32613, SRT, “left ventricle apical anterior segment”)</p>
<p>AFI/AAS PeakSysSL</p> <p>Alias: AAS PeakSysSL</p>	<p>(GEU-106-0002, 99GEMS, “Peak Longitudinal Strain”)</p>	<p>(G-C036, SRT, “Measurement Method”) = (GEU-106-0018, 99GEMS, “AFI”)</p> <p>(R-4089A, SRT, “Cardiac Cycle Point”) = (F-32020, SRT, “Systole”)</p> <p>(G-C0E3, SRT, “Finding Site”) =</p>

		(GEU-106-0026, 99GEMS, “left ventricle apical anteroseptal segment”)
<p>AFI/AS PeakSysSL Alias: AS PeakSysSL</p>	(GEU-106-0002, 99GEMS, “Peak Longitudinal Strain”)	<p>(G-C036, SRT, “Measurement Method”) = (GEU-106-0018, 99GEMS, “AFI”)</p> <p>(R-4089A, SRT, “Cardiac Cycle Point”) = (F-32020, SRT, “Systole”)</p> <p>(G-C0E3, SRT, “Finding Site”) = (T-32614, SRT, “left ventricle apical septal segment”)</p>
<p>AFI/AI PeakSysSL Alias: AI PeakSysSL</p>	(GEU-106-0002, 99GEMS, “Peak Longitudinal Strain”)	<p>(G-C036, SRT, “Measurement Method”) = (GEU-106-0018, 99GEMS, “AFI”)</p> <p>(R-4089A, SRT, “Cardiac Cycle Point”) = (F-32020, SRT, “Systole”)</p> <p>(G-C0E3, SRT, “Finding Site”) = (T-32618, SRT, “left ventricle apical inferior segment”)</p>
<p>AFI/AP PeakSysSL Alias: AP PeakSysSL</p>	(GEU-106-0002, 99GEMS, “Peak Longitudinal Strain”)	<p>(G-C036, SRT, “Measurement Method”) = (GEU-106-0018, 99GEMS, “AFI”)</p> <p>(R-4089A, SRT, “Cardiac Cycle Point”) = (F-32020, SRT, “Systole”)</p> <p>(G-C0E3, SRT, “Finding Site”) = (GEU-106-0025, 99GEMS, “left ventricle apical posterior segment”)</p>
<p>AFI/AL PeakSysSL Alias: AL PeakSysSL</p>	(GEU-106-0002, 99GEMS, “Peak Longitudinal Strain”)	<p>(G-C036, SRT, “Measurement Method”) = (GEU-106-0018, 99GEMS, “AFI”)</p> <p>(R-4089A, SRT, “Cardiac Cycle Point”) = (F-32020, SRT, “Systole”)</p> <p>(G-C0E3, SRT, “Finding Site”) = (T-3261C, SRT, “left ventricle</p>

		apical lateral segment”)
4DAutoLAQ/Vmin Alias: 4DAutoLAQ Vmin	(GEU-106-0123, 99GEMS, “Left Atrium minimal volume by 4D LA quantification tool”)	(G-C036, SRT, “Measurement Method”) = (GEU-106-0114, 99GEMS, “4D auto LA quantification tool”)
4DAutoLAQ/Vmax Alias: 4DAutoLAQ Vmax	(G-0383, SRT, “Left Atrium Systolic Volume”)	(G-C036, SRT, “Measurement Method”) = (GEU-106-0114, 99GEMS, “4D auto LA quantification tool”)
4DAutoLAQ/VpreA Alias: 4DAutoLAQ VpreA	(GEU-106-0124, 99GEMS, “Left Atrium volume at preA time by 4D LA quantification tool”)	(G-C036, SRT, “Measurement Method”) = (GEU-106-0114, 99GEMS, “4D auto LA quantification tool”)
4DAutoLAQ/GLS_R Alias: 4DAutoLAQ GLS_R	(GEU-106-0115, 99GEMS, “Left Atrium global longitudinal strain in reservoir phase”)	(G-C036, SRT, “Measurement Method”) = (GEU-106-0114, 99GEMS, “4D auto LA quantification tool”)
4DAutoLAQ/GLS_CD Alias: 4DAutoLAQ GLS_CD	(GEU-106-0116, 99GEMS, “Left Atrium global longitudinal strain in conduit phase”)	(G-C036, SRT, “Measurement Method”) = (GEU-106-0114, 99GEMS, “4D auto LA quantification tool”)
4DAutoLAQ/GLS_CT Alias: 4DAutoLAQ GLS_CT	(GEU-106-0117, 99GEMS, “Left Atrium global longitudinal strain in contractile phase”)	(G-C036, SRT, “Measurement Method”) = (GEU-106-0114, 99GEMS, “4D auto LA quantification tool”)
4DAutoLAQ/GCS_R Alias: 4DAutoLAQ GCS_R	(GEU-106-0118, 99GEMS, “Left Atrium global circumferential strain in reservoir phase”)	(G-C036, SRT, “Measurement Method”) = (GEU-106-0114, 99GEMS, “4D auto LA quantification tool”)
4DAutoLAQ/GCS_CD Alias: 4DAutoLAQ GCS_CD	(GEU-106-0119, 99GEMS, “Left Atrium global circumferential strain in conduit phase”)	(G-C036, SRT, “Measurement Method”) = (GEU-106-0114, 99GEMS, “4D auto LA quantification tool”)
4DAutoLAQ/GCS_CT Alias: 4DAutoLAQ GCS_CT	(GEU-106-0120, 99GEMS, “Left Atrium global circumferential strain in contractile phase”)	(G-C036, SRT, “Measurement Method”) = (GEU-106-0114, 99GEMS, “4D auto LA quantification tool”)
4DAutoLAQ/EV	(GEU-106-0121, 99GEMS, “Left Atrium Emptying	(G-C036, SRT, “Measurement Method”) = (GEU-106-0114,

Alias: 4DAutoLAQ EV	Volume by 4D LA quantification tool")	99GEMS, "4D auto LA quantification tool")
4DAutoLAQ/EF Alias: 4DAutoLAQ EF	(GEU-106-0122, 99GEMS, "Left Atrium Emptying Fraction by 4D LA quantification tool")	(G-C036, SRT, "Measurement Method") = (GEU-106-0114, 99GEMS, "4D auto LA quantification tool")
CardiacWork/CW(GWI) Alias: CW(GWI)	(GEU-106-0062, 99GEMS, "Global Work Index")	(R-4089A, SRT, "Cardiac Cycle Point") = (G-0387, SRT, "Mitral Valve Closure to Opening Time") (G-C036, SRT, "Measurement Method") = (GEU-106-0061, 99GEMS, "MyocardialWork Quantification Tool")
CardiacWork/CW(GCW) Alias: CW(GCW)	(GEU-106-0063, 99GEMS, "Global Constructive Work")	(R-4089A, SRT, "Cardiac Cycle Point") = (G-0387, SRT, "Mitral Valve Closure to Opening Time") (G-C036, SRT, "Measurement Method") = (GEU-106-0061, 99GEMS, "MyocardialWork Quantification Tool")
CardiacWork/CW(GWW) Alias: CW(GWW)	(GEU-106-0064, 99GEMS, "Global Wasted Work")	(R-4089A, SRT, "Cardiac Cycle Point") = (G-0387, SRT, "Mitral Valve Closure to Opening Time") (G-C036, SRT, "Measurement Method") = (GEU-106-0061, 99GEMS, "MyocardialWork Quantification Tool")
CardiacWork/CW(GWE) Alias: CW(GWE)	(GEU-106-0065, 99GEMS, "Global Work Efficiency")	(R-4089A, SRT, "Cardiac Cycle Point") = (G-0387, SRT, "Mitral Valve Closure to Opening Time") (G-C036, SRT, "Measurement Method") = (GEU-106-0061, 99GEMS, "MyocardialWork Quantification Tool")
CardiacWork/CW(BPS) Alias: CW(BPS)	(F-008EC, SRT, "Systolic Blood Pressure")	(G-C036, SRT, "Measurement Method") = (GEU-106-0061, 99GEMS, "MyocardialWork Quantification Tool")
CardiacWork/CW(BPD)	(F-008ED, SRT, "Diastolic	(G-C036, SRT, "Measurement Method") = (GEU-106-0061,

Alias: CW(BPD)	Blood Pressure”)	99GEMS, “MyocardialWork Quantification Tool”)
PV A Dur-MV A Dur Alias: PV A- PV D	(GEU-106-0070, 99GEMS, “Difference between the Pulmonary Vein A-wave duration and the mitral inflow A-wave duration”)	(G-0373, SRT, «Image Mode») = (R-409E4, SRT, «Doppler Pulsed»)
PV A Dur/MV VTI Alias: PV A Dur/MV VTI	(GEU-106-0071, 99GEMS, “Ratio of Pulmonary Vein A-wave duration by Mitral Valve VTI”)	(G-0373, SRT, «Image Mode») = (R-409E4, SRT, «Doppler Pulsed»)
PV A Dur/MV A Dur Alias: PV A Dur/MV A Dur	(GEU-106-0072, 99GEMS, “Ratio of Pulmonary Vein A-wave duration by Mitral inflow A-wave duration”)	(G-0373, SRT, «Image Mode») = (R-409E4, SRT, «Doppler Pulsed»)

Section Right Ventricle

GEU Parameter ID (and corresponding alias)	Base Measurement Concept Name	Concept or Acquisition Context Modifier
TomTec/RVFunction/EDV Alias: RVEDV(TomTec)	(8822-3, LN, “Right Ventricular ED Volume”)	(G-C036, SRT, “Measurement Method”) = (GEU-106-0022, 99GEMS, “4D Right Ventricle Volume”)
TomTec/RVFunction/ESV Alias: RVESV(TomTec)	(8824-5, LN, “Right Ventricular ES Volume”)	(G-C036, SRT, “Measurement Method”) = (GEU-106-0022, 99GEMS, “4D Right Ventricle Volume”)
TomTec/RVFunction/SV Alias: RVSV(TomTec)	(F-32120, SRT, “Stroke Volume”)	(G-C036, SRT, “Measurement Method”) = (GEU-106-0022, 99GEMS, “4D Right Ventricle Volume”)
TomTec/RVFunction/EF Alias: RVEF(TomTec)	(10231-9, LN, “RV Ejection Fraction”)	(G-C036, SRT, “Measurement Method”) = (GEU-106-0022, 99GEMS, “4D Right Ventricle Volume”)
MM/RVOT Alias: RVOT	(G-038F, SRT, “Cardiovascular Orifice Diameter”)	(G-C0E3, SRT, “Finding Site”) = (T-32550, SRT, “Right Ventricle Outflow Tract”)

		(G-0373, SRT, "Image Mode") = (G-0394, SRT, "M mode")
2D/RVEF(A-L A4C) Alias: RVEF A-L A4C	(F-02268, SRT, "Right Ventricular Ejection Fraction")	(111031, DCM, "Image View") = (G-A19C, SRT, "Apical four chamber") (G-C036, SRT, "Measurement Method") = (125205, DCM, "Area-Length Single Plane")
2D/RVEF(MOD A4C) Alias: RVEF MOD A4C	(F-02268, SRT, "Right Ventricular Ejection Fraction")	(111031, DCM, "Image View") = (G-A19C, SRT, "Apical four chamber") (G-C036, SRT, "Measurement Method") = (125208, DCM, "Method of Disks, Single Plane")
2D/RVOT Diam Alias: RVOT Diam	(G-038F, SRT, "Cardiovascular Orifice Diameter")	(G-C0E3, SRT, "Finding Site") = (T-32550, SRT, "Right Ventricle Outflow Tract") (G-0373, SRT, "Image Mode") = (G-03A2, SRT, "2D mode") or (R-409E2, SRT, "Doppler Color Flow") depending on scan mode
2D/RVAWd Alias: RVAWd	(18153-7, LN, "Right Ventricular Anterior Wall Diastolic Thickness")	(G-0373, SRT, "Image Mode") = (G-03A2, SRT, "2D mode") or (R-409E2, SRT, "Doppler Color Flow") depending on scan mode
2D/RVAWs Alias: RVAWs	(18157-8, LN, "Right Ventricular Anterior Wall Systolic Thickness")	(G-0373, SRT, "Image Mode") = (G-03A2, SRT, "2D mode") or (R-409E2, SRT, "Doppler Color Flow") depending on scan mode
2D/RVIDd Alias: RVIDd	(20304-2, LN, "Right Ventricular Internal Diastolic Dimension")	
2D/RVIDs Alias: RVIDs	(20305-9, LN, "Right Ventricular Internal Systolic Dimension")	(G-0373, SRT, "Image Mode") = (G-03A2, SRT, "2D mode") or (R-409E2, SRT, "Doppler Color Flow") depending on scan mode
2D/RVD Major Alias: RV Major	(G-A193, SRT, "Major Axis")	(G-0373, SRT, "Image Mode") = (G-03A2, SRT, "2D mode") or (R-409E2, SRT, "Doppler Color Flow") depending on scan mode

<p>2D/RVD Minor Alias: RV Minor</p>	<p>(G-A194, SRT, "Minor Axis")</p>	<p>(G-0373, SRT, "Image Mode") = (G-03A2, SRT, "2D mode") or (R-409E2, SRT, "Doppler Color Flow") depending on scan mode</p>
<p>2D/RVD Minor Base Alias: RV Minor Base</p>	<p>(80080-5, LN, "Right ventricular base Minor Axis at end diastole, 4-chamber view")</p>	<p>(G-0373, SRT, "Image Mode") = (G-03A2, SRT, "2D mode") (R-4089A, SRT, "Cardiac Cycle Point") = (F-32011, SRT, "End Diastole") (111031, DCM, "Image View") = (G-A19C, SRT, "Apical four chamber")</p>
<p>2D/RVA Diastole Alias: RVA Diastole</p>	<p>(GEU-106-0054, 99GEMS, "Right Ventricular Diastolic Area")</p>	<p>(G-0373, SRT, "Image Mode") = (G-03A2, SRT, "2D mode") (R-4089A, SRT, "Cardiac Cycle Point") = (F-32011, SRT, "End Diastole")</p>
<p>2D/RVA Systole Alias: RVA Systole</p>	<p>(GEU-106-0055, 99GEMS, "Right Ventricular Systolic Area")</p>	<p>(G-0373, SRT, "Image Mode") = (G-03A2, SRT, "2D mode") (R-4089A, SRT, "Cardiac Cycle Point") = (109070, DCM, "End Systole")</p>
<p>2D/RVOT Area Alias: RVOT Area</p>	<p>(G-038E, SRT, "Cardiovascular Orifice Area")</p>	<p>(G-C0E3, SRT, "Finding Site") = (T-32550, SRT, "Right Ventricle Outflow Tract") (G-0373, SRT, "Image Mode") = (G-03A2, SRT, "2D mode") or (R-409E2, SRT, "Doppler Color Flow") depending on scan mode</p>
<p>2D/RV FAC Alias: RV FAC</p>	<p>(78175-7, LN, "Right ventricular Fraction area change by US 2D")</p>	<p>(G-0373, SRT, "Image Mode") = (G-03A2, SRT, "2D mode")</p>
<p>4DAutoRVQ/EDV Alias: RV EDV</p>	<p>(8822-3, LN, "Right Ventricular ED Volume")</p>	<p>(G-0373, SRT, "Image Mode") = (125231, DCM, "3D mode") (G-C036, SRT, "Measurement Method") = (GEU-106-0048, 99GEMS, "4D auto RV quantification tool") (R-4089A, SRT, "Cardiac Cycle Point") = (109022, DCM, "End Diastole")</p>

<p>4DAutoRVQ/ESV Alias: RV ESV</p>	<p>(8824-5, LN, “Right Ventricular ES Volume”)</p>	<p>(G-0373, SRT, “Image Mode”) = (125231, DCM, “3D mode”) (G-C036, SRT, “Measurement Method”) = (GEU-106-0048, 99GEMS, “4D auto RV quantification tool”) (R-4089A, SRT, “Cardiac Cycle Point”) = (F-32020, SRT, “Systole”)</p>
<p>4DAutoRVQ/EF Alias: RV EF</p>	<p>(F-02268, SRT, “Right Ventricular Ejection Fraction”)</p>	<p>(G-0373, SRT, “Image Mode”) = (125231, DCM, “3D mode”) (G-C036, SRT, “Measurement Method”) = (GEU-106-0048, 99GEMS, “4D auto RV quantification tool”)</p>
<p>4DAutoRVQ/SV Alias: RV SV</p>	<p>(F-02268, SRT, “Right Ventricular Stroke Volume”)</p>	<p>(G-0373, SRT, “Image Mode”) = (125231, DCM, “3D mode”) (G-C036, SRT, “Measurement Method”) = (GEU-106-0048, 99GEMS, “4D auto RV quantification tool”)</p>
<p>4DAutoRVQ/Dd_base Alias: RV Dd base</p>	<p>(GEU-106-0049, 99GEMS, “RV basal minor axis at end diastole on A4C from 4D image”)</p>	<p>(G-0373, SRT, “Image Mode”) = (125231, DCM, “3D mode”) (G-C036, SRT, “Measurement Method”) = (GEU-106-0048, 99GEMS, “4D auto RV quantification tool”) (111031, DCM, “Image View”) = (G-A19C, SRT, “Apical four chamber”) (R-4089A, SRT, “Cardiac Cycle Point”) = (109022, DCM, “End Diastole”)</p>
<p>4DAutoRVQ/Dd_mid Alias: RV Dd mid</p>	<p>(GEU-106-0050, 99GEMS, “RV mid-cavity minor axis at end diastole on A4C from 4D image”)</p>	<p>(G-0373, SRT, “Image Mode”) = (125231, DCM, “3D mode”) (G-C036, SRT, “Measurement Method”) = (GEU-106-0048, 99GEMS, “4D auto RV quantification tool”) (111031, DCM, “Image View”) = (G-A19C, SRT, “Apical four chamber”) (R-4089A, SRT, “Cardiac Cycle Point”) = (109022, DCM, “End Diastole”)</p>
<p>4DAutoRVQ/Ld Alias: RV Ld</p>	<p>(GEU-106-0051, 99GEMS, “RV major axis at end diastole on A4C from 4D image”)</p>	<p>(G-0373, SRT, “Image Mode”) = (125231, DCM, “3D mode”) (G-C036, SRT, “Measurement Method”) = (GEU-106-0048,</p>

		99GEMS, “4D auto RV quantification tool”) (111031, DCM, “Image View”) = (G-A19C, SRT, “Apical four chamber”) (R-4089A, SRT, “Cardiac Cycle Point”) = (109022, DCM, “End Diastole”)
4DAutoRVQ/FAC Alias: RV FAC	(GEU-106-0053, 99GEMS, “RV FAC on user-selected from 4D image”)	(G-0373, SRT, “Image Mode”) = (125231, DCM, “3D mode”) (G-C036, SRT, “Measurement Method”) = (GEU-106-0048, 99GEMS, “4D auto RV quantification tool”) (111031, DCM, “Image View”) = (G-A19C, SRT, “Apical four chamber”)
4DAutoRVQ/EDV_index Alias: RV EDV index	(8822-3, LN, “Right Ventricular ED Volume)	(G-0373, SRT, “Image Mode”) = (125231, DCM, “3D mode”) (G-C036, SRT, “Measurement Method”) = (GEU-106-0048, 99GEMS, “4D auto RV quantification tool”) (R-4089A, SRT, “Cardiac Cycle Point”) = (109022, DCM, “End Diastole”) (121425, DCM, “Index”) = (8277-6, LN, “Body Surface Area”)
4DAutoRVQ/ESV_index Alias: RV ESV index	(8824-5, LN, “Right Ventricular ES Volume”)	(G-0373, SRT, “Image Mode”) = (125231, DCM, “3D mode”) (G-C036, SRT, “Measurement Method”) = (GEU-106-0048, 99GEMS, “4D auto RV quantification tool”) (R-4089A, SRT, “Cardiac Cycle Point”) = (F-32020, SRT, “Systole”) (121425, DCM, “Index”) = (8277-6, LN, “Body Surface Area”)
4DAutoRVQ/SV_index Alias: RV SV index	(F-02268, SRT, “Right Ventricular Stroke Volume”)	(G-0373, SRT, “Image Mode”) = (125231, DCM, “3D mode”) (G-C036, SRT, “Measurement Method”) = (GEU-106-0048, 99GEMS, “4D auto RV quantification tool”) (121425, DCM, “Index”) = (8277-6, LN, “Body Surface Area”)
RVLd(A4C)	(18078-6, LN, “Right Ventricular Major Axis	(111031, DCM, “Image View”) = (G-A19C, SRT, “Apical four chamber”)

Alias: RVLd(A4C)	Diastolic Dimension")	
RVAd(A4C) Alias: RVAd(A4C)	(G-A166, SRT, "Area")	(111031, DCM, "Image View") = (G-A19C, SRT, "Apical four chamber") (R-4089A, SRT, "Cardiac Cycle Point") = (F-32010, SRT, "Diastole")
RVEDV(A-L A4C) Alias: RVEDV A-L A4C	(8822-3, LN, "Right Ventricular ED Volume")	(111031, DCM, "Image View") = (G-A19C, SRT, "Apical four chamber") (G-C036, SRT, "Measurement Method") = (125205, DCM, "Area-Length Single Plane")
RVEDV(MOD A4C) Alias: RVEDV(MOD A4C)	(8822-3, LN, "Right Ventricular ED Volume")	(111031, DCM, "Image View") = (G-A19C, SRT, "Apical four chamber") (G-C036, SRT, "Measurement Method") = (125208, DCM, "Method of Disks, Single Plane")
RVLs(A4C) Alias: RVLs(A4C)	(18079-4, LN, "Right Ventricular Major Axis Systolic Dimension")	(111031, DCM, "Image View") = (G-A19C, SRT, "Apical four chamber")
RVAs(A4C) Alias: RVAs(A4C)	(G-A166, SRT, "Area")	(111031, DCM, "Image View") = (G-A19C, SRT, "Apical four chamber") (R-4089A, SRT, "Cardiac Cycle Point") = (F-32020, SRT, "Systole")
RVESV(A-L A4C) Alias: RVESV A-L A4C	(8824-5, LN, "Right Ventricular ES Volume")	(111031, DCM, "Image View") = (G-A19C, SRT, "Apical four chamber") (G-C036, SRT, "Measurement Method") = (125205, DCM, "Area-Length Single Plane")
RVESV(MOD A4C) Alias: RVESV(MOD A4C)	(8824-5, LN, "Right Ventricular ES Volume")	(111031, DCM, "Image View") = (G-A19C, SRT, "Apical four chamber") (G-C036, SRT, "Measurement Method") = (125208, DCM, "Method of Disks, Single Plane")
MM/RVIDd Alias: RVIDd	(20304-2, LN, "Right Ventricular Internal Diastolic Dimension")	(G-0373, SRT, «Image Mode») = (G-0394, SRT, «M mode»)
MM/RVIDs Alias: RVIDs	(20305-9, LN, "Right Ventricular Internal Systolic Dimension")	(G-0373, SRT, «Image Mode») = (G-0394, SRT, «M mode»)
MM/RVAWd	(18153-7, LN, "Right	(G-0373, SRT, «Image Mode») = (G-

Alias: RVAWd	Ventricular Anterior Wall Diastolic Thickness")	0394, SRT, «M mode»)
MM/RVAWs Alias: RVAWs	(18157-8, LN, "Right Ventricular Anterior Wall Systolic Thickness")	(G-0373, SRT, «Image Mode») = (G-0394, SRT, «M mode»)
MM/RVPEP Alias: RVPEP	(20301-8, LN, "Right Ventricle Pre Ejection Period")	(G-0373, SRT, «Image Mode») = (G-0394, SRT, «M mode»)
MM/RVET Alias: RVET	(20222-6, LN, "Ejection Time")	(G-0373, SRT, «Image Mode») = (G-0394, SRT, «M mode»)
MM/RVPEP/ET Ratio Alias: RVPEP ET Ratio	(59088-5, LN, "Right Ventricular Pre-ejection time/Ejection Time")	(G-0373, SRT, «Image Mode») = (G-0394, SRT, «M mode»)
Est RVSP Alias: RVSP	(G-0380, SRT, "Right Ventricular Peak Systolic Pressure")	
RVOT Vmax Alias: RVOT Vmax	(11726-7, LN, "Peak Velocity")	(G-C0E3, SRT, "Finding Site") = (T-32550, SRT, "Right Ventricle Outflow Tract")
RVOT Vmax P Alias: RVOT Vmax	(11726-7, LN, "Peak Velocity")	(G-C0E3, SRT, "Finding Site") = (T-32550, SRT, "Right Ventricle Outflow Tract")
RVOT maxPG Alias: RVOT maxPG	(20247-3, LN, "Peak Gradient")	(G-C0E3, SRT, "Finding Site") = (T-32550, SRT, "Right Ventricle Outflow Tract")
RVOT Vmean Alias: RVOT Vmean	(20352-1, LN, "Mean Velocity")	(G-C0E3, SRT, "Finding Site") = (T-32550, SRT, "Right Ventricle Outflow Tract")
RVOT meanPG Alias: RVOT meanPG	(20256-4, LN, "Mean Gradient")	(G-C0E3, SRT, "Finding Site") = (T-32550, SRT, "Right Ventricle Outflow Tract")
RVOT VTI Alias: RVOT VTI	(20354-7, LN, "Velocity Time Integral")	(G-C0E3, SRT, "Finding Site") = (T-32550, SRT, "Right Ventricle Outflow Tract")
RVOT Env.Ti	(GEU-106-0085, 99GEMS, "Time duration of the VTI	(G-0373, SRT, «Image Mode») = (R-

Alias: RVOT Env.Ti	trace on RVOT")	409E4, SRT, «Doppler Pulsed»)
RVOT HR Alias: HR	(8867-4, LN, "Heart rate")	
RVOT SV Alias: RVOT SV	(F-32120, SRT, "Stroke Volume")	(G-C0E3, SRT, "Finding Site") = (T-32550, SRT, "Right Ventricle Outflow Tract")
RVOT SI Alias: RVOT SI	(F-00078, SRT, "Stroke Index")	(G-C0E3, SRT, "Finding Site") = (T-32550, SRT, "Right Ventricle Outflow Tract")
RVOT CO Alias: RVOT CO	(F-32100, SRT, "Cardiac Output")	(G-C0E3, SRT, "Finding Site") = (T-32550, SRT, "Right Ventricle Outflow Tract")
RVOT CI Alias: RVOT CI	(F-32110, SRT, "Cardiac Index")	(G-C0E3, SRT, "Finding Site") = (T-32550, SRT, "Right Ventricle Outflow Tract")
RVET Alias: RVET	(79929-6, LN, "Right Ventricular Ejection Time by US doppler")	(G-0373, SRT, "Image Mode") = (R-409E4, SRT, "Doppler Pulsed") or (G-0373, SRT, "Image Mode") = (R-409E3, SRT, "Doppler Continuous Wave") (G-C0E3, SRT, "Finding Site") = (T-32550, SRT, "Right Ventricle Outflow Tract")
RVPEP Alias: RVPEP	(20301-8, LN, "Right Ventricle Pre Ejection Period")	(G-0373, SRT, "Image Mode") = (R-409E4, SRT, "Doppler Pulsed") or (G-0373, SRT, "Image Mode") = (R-409E3, SRT, "Doppler Continuous Wave") (G-C0E3, SRT, "Finding Site") = (T-32550, SRT, "Right Ventricle Outflow Tract")
RVPEP/ET Ratio Alias: RVPEP/ET Ratio	(59088-5, LN, "Ventricular Pre Ejection Time/Ejection time by US")	(G-0373, SRT, "Image Mode") = (R-409E4, SRT, "Doppler Pulsed") (G-C0E3, SRT, "Finding Site") = (T-32550, SRT, "Right Ventricle Outflow Tract")
RIMP	(G-0381, SRT, "Right	(G-C0E3, SRT, "Finding Site") = (T-

Alias: RIMP	Ventricular Index of Myocardial Performance")	32500, SRT, "Right Ventricle") (G-0373, SRT, "Image Mode") = (R-409E4, SRT, "Doppler Pulsed")
S' (Doppler) Alias: RV S'	(59133-9, LN, "Peak Tissue Velocity")	(R-4089A, SRT, "Cardiac Cycle Point") = (F-32020, SRT, "Systole")

Section Left Atrium

GEU Parameter ID (and corresponding alias)	Base Measurement Concept Name	Concept or Acquisition Context Modifier
2D/Ao/LA Alias: Ao/LA	(17985-3, LN, "Left Atrium to Aortic Root Ratio")	(G-0373, SRT, "Image Mode") = (G-03A2, SRT, "2D mode") or (R-409E2, SRT, "Doppler Color Flow") depending on scan mode
MM/Ao/LA Alias: Ao/LA	(17985-3, LN, "Left Atrium to Aortic Root Ratio")	(G-0373, SRT, «Image Mode») = (G-0394, SRT, «M mode»)
MM/LAAo/LA/Ao Alias: LA/Ao	(17985-3, LN, "Left Atrium to Aortic Root Ratio")	(G-0373, SRT, «Image Mode») = (G-0394, SRT, «M mode»)
MM/LAAo/Ao/LA Alias: Ao/LA	(17985-3, LN, "Left Atrium to Aortic Root Ratio")	(G-0373, SRT, «Image Mode») = (G-0394, SRT, «M mode»)
2D/LA Major Alias: LA Major	(G-A193, SRT, "Major Axis")	(G-0373, SRT, "Image Mode") = (G-03A2, SRT, "2D mode") or (R-409E2, SRT, "Doppler Color Flow") depending on scan mode
2D/LA Minor Alias: LA Minor	(G-A194, SRT, "Minor Axis")	(G-0373, SRT, "Image Mode") = (G-03A2, SRT, "2D mode") or (R-409E2, SRT, "Doppler Color Flow") depending on scan mode
2D/LA Alias: LA Diam	(M-02550, SRT, "Diameter")	(G-0373, SRT, "Image Mode") = (G-03A2, SRT, "2D mode") or (R-409E2, SRT, "Doppler Color Flow") depending on scan

		mode
2D/LA D1 Alias: LA Diam 1	(GEU-106-0092, 99GEMS, "Left atrium diameter 1 in LA Ellipsoid Volume")	
2D/LA D2 Alias: LA Diam 2	(GEU-106-0093, 99GEMS, "Left atrium diameter 2 in LA Ellipsoid Volume")	
2D/LA D3 Alias: LA Diam 3	(GEU-106-0094, 99GEMS, "Left atrium diameter 3 in LA Ellipsoid Volume")	
2D/LA SupInf D Alias: LA SupInf D	(GEU-106-0095, 99GEMS, "Left Atrium Superior-Inferior Diameter")	
2D/LA MedLat D Alias: LA MedLat D	(GEU-106-0096, 99GEMS, "Left Atrium Medial-Lateral Diameter")	
2D/LA AntPost D Alias: LA AntPost D	(29469-4, LN, "Left Atrium Antero-posterior Systolic Dimension")	
2D/LAA Systole Alias: LAA Systole	(17977-0, LN, "Left Atrium Systolic Area")	(G-0373, SRT, "Image Mode") = (G-03A2, SRT, "2D mode") (R-4089A, SRT, "Cardiac Cycle Point") = (F-32020, SRT, "Systole")
2D/LAA Diastole Alias: LAA Diastole	(GEU-106-0058, 99GEMS, "Left Atrium Area at diastole")	(G-0373, SRT, "Image Mode") = (G-03A2, SRT, "2D mode") (R-4089A, SRT, "Cardiac Cycle Point") = (F-32010, SRT, "Diastole")
2D/LA/Ao Alias: LA/Ao	(17985-3, LN, "Left Atrium to Aortic Root Ratio")	(G-0373, SRT, "Image Mode") = (G-03A2, SRT, "2D mode") or (R-409E2, SRT, "Doppler Color Flow") depending on scan mode
2D/LA Area Alias: LA Area	(G-A166, SRT, "Area")	(G-0373, SRT, "Image Mode") = (G-03A2, SRT, "2D mode") or (R-409E2, SRT, "Doppler Color Flow") depending on scan mode
2D/LAvol/Ravol	(59131-3, LN, "Left Atrium	

Alias: Lavol Ravol Ratio	volume/Right Atrium volume")	
2D/LA Volume Alias: LA Volume	(GEU-106-0097, 99GEMS, "Left Atrium volume by Ellipsoid Method")	
2D/LA Ellipsoid Volume Alias: LA Ellipsoid Volume	(GEU-106-0097, 99GEMS, "Left Atrium volume by Ellipsoid Method")	
LALd(A4C) Alias: LALd A4C	(29467-8, LN, "Left Atrium Superior-Inferior Dimension, 4-chamber view")	(R-4089A, SRT, "Cardiac Cycle Point") = (F-32010, SRT, "Diastole")
LAAAd(A4C) Alias: LAAAd A4C	(17977-0, LN, "Left Atrium Area A4C view")	(R-4089A, SRT, "Cardiac Cycle Point") = (F-32010, SRT, "Diastole")
LAEDV(A-L A4C) Alias: LAEDV A-L A4C	(122407, DCM, "Left Atrial End Diastolic Volume")	(111031, DCM, "Image View") = (G-A19C, SRT, "Apical four chamber") = (G-C036, SRT, "Measurement Method") = (125205, DCM, "Area-Length Single Plane")
LAESV(A-L A4C) Alias: LAESV A-L A4C	(G-0383, SRT, "Left Atrium Systolic Volume")	(111031, DCM, "Image View") = (G-A19C, SRT, "Apical four chamber") = (G-C036, SRT, "Measurement Method") = (125205, DCM, "Area-Length Single Plane")
LAEDV(MOD A4C) Alias: LAEDV MOD A4C	(122407, DCM, "Left Atrial End Diastolic Volume")	(111031, DCM, "Image View") = (G-A19C, SRT, "Apical four chamber") = (G-C036, SRT, "Measurement Method") = (125208, DCM, "Method of Disks, Single Plane")
LALs(A4C) Alias: LALs A4C	(29467-8, LN, "Left Atrium Superior-Inferior Dimension, 4-chamber view")	(R-4089A, SRT, "Cardiac Cycle Point") = (F-32020, SRT, "Systole")
LAAs(A4C) Alias: LAAs A4C	(17977-0, LN, "Left Atrium Area A4C view")	(R-4089A, SRT, "Cardiac Cycle Point") = (F-32020, SRT, "Systole")
LAESV(MOD A4C) Alias: LAESV MOD	(G-0383, SRT, "Left Atrium Systolic Volume")	(111031, DCM, "Image View") = (G-A19C, SRT, "Apical four chamber") = (G-C036, SRT, "Measurement Method") =

A4C		(125208, DCM, "Method of Disks, Single Plane")
LALd(A2C) Alias: LALd A2C	(GEU-106-0102, 99GEMS, "Left Atrium Length on Apical two chamber view")	(R-4089A, SRT, "Cardiac Cycle Point") = (F-32011, SRT, "End Diastole") (111031, DCM, "Image View") = (G-A19B, SRT, "Apical two chamber")
LALs(A2C) Alias: LALs A2C	(GEU-106-0102, 99GEMS, "Left Atrium Length on Apical two chamber view")	(R-4089A, SRT, "Cardiac Cycle Point") = (109070, DCM, "End Systole") (111031, DCM, "Image View") = (G-A19B, SRT, "Apical two chamber")
LAAd(A2C) Alias: LAAd A2C	(GEU-106-0103, 99GEMS, "Left Atrium Area on Apical two chamber view")	(R-4089A, SRT, "Cardiac Cycle Point") = (F-32011, SRT, "End Diastole") (111031, DCM, "Image View") = (G-A19B, SRT, "Apical two chamber")
LAAs(A2C) Alias: LAAs A2C	(GEU-106-0103, 99GEMS, "Left Atrium Area on Apical two chamber view")	(R-4089A, SRT, "Cardiac Cycle Point") = (109070, DCM, "End Systole") (111031, DCM, "Image View") = (G-A19B, SRT, "Apical two chamber")
LAEDV(A-L A2C) Alias: LAEDV A-L A2C	(122407, DCM, "Left Atrial End Diastolic Volume")	(111031, DCM, "Image View") = (G-A19B, SRT, "Apical two chamber") (G-C036, SRT, "Measurement Method") = (125205, DCM, "Area-Length Single Plane")
LAEDV(MOD A2C) Alias: LAEDV MOD A2C	(122407, DCM, "Left Atrial End Diastolic Volume")	(111031, DCM, "Image View") = (G-A19B, SRT, "Apical two chamber") (G-C036, SRT, "Measurement Method") = (125208, DCM, "Method of Disks, Single Plane")
LAESV(A-L A2C) Alias: LAESV A-L A2C	(G-0383, SRT, "Left Atrium Systolic Volume")	(111031, DCM, "Image View") = (G-A19B, SRT, "Apical two chamber") (G-C036, SRT, "Measurement Method") = (125205, DCM, "Area-Length Single Plane")
LAESV(MOD A2C) Alias: LAESV MOD A2C	(G-0383, SRT, "Left Atrium Systolic Volume")	(111031, DCM, "Image View") = (G-A19B, SRT, "Apical two chamber") (G-C036, SRT, "Measurement Method") = (125208, DCM, "Method of Disks, Single Plane")

		Plane”)
MM/LA/Ao Alias: LA/Ao	(17985-3, LN, “Left Atrium to Aortic Root Ratio”)	(G-0373, SRT, «Image Mode») = (G-0394, SRT, «M mode»)
MM/LA Alias: LA Diam	(29469-4, LN, “Left Atrium Antero-posterior Systolic Dimension”)	(G-0373, SRT, «Image Mode») = (G-0394, SRT, «M mode»)
2D/LAEDV(A-L) Alias: LAEDV(A-L)	(122407, DCM, “Left Atrial End Diastolic Volume”)	(G-0373, SRT, “Image Mode”) = (G-03A2, SRT, “2D mode”) or (R-409E2, SRT, “Doppler Color Flow”) depending on scan mode (G-C036, SRT, “Measurement Method”) = (125204, DCM, “Area-Length Biplane”)
2D/LAEDVI(A-L) Alias: LAEDV Index (A-L)	(GEU-106-0027, 99GEMS, “Left Atrial End Diastolic Volume Index”)	(G-0373, SRT, “Image Mode”) = (G-03A2, SRT, “2D mode”) or (R-409E2, SRT, “Doppler Color Flow”) depending on scan mode (G-C036, SRT, “Measurement Method”) = (125204, DCM, “Area-Length Biplane”)
2D/LAESV(A-L) Alias: LAESV(A-L)	(G-0383, SRT, “Left Atrium Systolic Volume”)	(G-0373, SRT, “Image Mode”) = (G-03A2, SRT, “2D mode”) or (R-409E2, SRT, “Doppler Color Flow”) depending on scan mode (G-C036, SRT, “Measurement Method”) = (125204, DCM, “Area-Length Biplane”)
LAEDV(MOD BP) Alias: LAEDV(MOD BP)	(122407, DCM, “Left Atrial End Diastolic Volume”)	(G-0373, SRT, “Image Mode”) = (G-03A2, SRT, “2D mode”) or (R-409E2, SRT, “Doppler Color Flow”) depending on scan mode (G-C036, SRT, “Measurement Method”) = (125207, DCM, “Method of Disks, Biplane”)
LAESV(MOD BP) Alias: LAESV(MOD BP)	(G-0383, SRT, “Left Atrium Systolic Volume”)	(G-0373, SRT, “Image Mode”) = (G-03A2, SRT, “2D mode”) or (R-409E2, SRT, “Doppler Color Flow”) depending on scan mode (G-C036, SRT, “Measurement Method”) = (125207, DCM, “Method of Disks, Biplane”)
SD/Laappendix Vmax	(29486-8, LN, “Left Atrial Appendage Peak Velocity”)	

Alias: Laappendix Vmax		
------------------------	--	--

Section Right Atrium

GEU Parameter ID (and corresponding alias)	Base Measurement Concept Name	Concept or Acquisition Context Modifier
2D/RA Alias: RA Diam	(M-02550, SRT, "Diameter")	(G-0373, SRT, "Image Mode") = (G-03A2, SRT, "2D mode") or (R-409E2, SRT, "Doppler Color Flow") depending on scan mode
2D/RA Area Alias: RA Area	(G-A166, SRT, "Area")	(G-0373, SRT, "Image Mode") = (G-03A2, SRT, "2D mode")
2D/RAA diastole Alias: RAA d	(GEU-106-0059, 99GEMS, "Right Atrium Area at Diastole")	(G-0373, SRT, "Image Mode") = (G-03A2, SRT, "2D mode") (R-4089A, SRT, "Cardiac Cycle Point") = (F-32010, SRT, "Diastole")
2D/RAA systole Alias: RAA s	(GEU-106-0060, 99GEMS, "Right Atrium Area at Systole")	(G-0373, SRT, "Image Mode") = (G-03A2, SRT, "2D mode") (R-4089A, SRT, "Cardiac Cycle Point") = (F-32020, SRT, "Systole")
2D/RAD Major Alias: RA Major	(G-A193, SRT, "Major Axis")	(G-0373, SRT, "Image Mode") = (G-03A2, SRT, "2D mode") or (R-409E2, SRT, "Doppler Color Flow") depending on scan mode
2D/RAD Minor Alias: RA Minor	(G-A194, SRT, "Minor Axis")	(G-0373, SRT, "Image Mode") = (G-03A2, SRT, "2D mode") or (R-409E2, SRT, "Doppler Color Flow") depending on scan mode
RAAs(A4C) Alias: RAAs	(17988-7, LN, "Right Atrium Systolic Area")	
RALd(A4C) Alias: RALd A4C	(29466-0, LN, Right Atrium Superior-Inferior Dimension, 4-chamber view")	(R-4089A, SRT, "Cardiac Cycle Point") = (F-32011, SRT, "End Diastole") (111031, DCM, "Image View") = (G-A19C,

		SRT, "Apical four chamber")
<p>RAAd(A4C) Alias: RAAd A4C</p>	<p>(17988-7, LN, "Right Atrium Area on Apical four chamber view")</p>	<p>(R-4089A, SRT, "Cardiac Cycle Point") = (F-32011, SRT, "End Diastole")</p> <p>(111031, DCM, "Image View") = (G-A19C, SRT, "Apical four chamber")</p>
<p>RAEDV(A-L A4C) Alias: RAEDV AL A4C</p>	<p>(GEU-106-0104, 99GEMS, "Right Atrium Volume")</p>	<p>(R-4089A, SRT, "Cardiac Cycle Point") = (F-32011, SRT, "End Diastole")</p> <p>(111031, DCM, "Image View") = (G-A19C, SRT, "Apical four chamber")</p> <p>(G-C036, SRT, "Measurement Method") = (125205, DCM, "Area-Length Single Plane")</p>
<p>RAEDV(MOD A4C) Alias: RAEDV MOD A4C</p>	<p>(GEU-106-0104, 99GEMS, "Right Atrium Volume")</p>	<p>(R-4089A, SRT, "Cardiac Cycle Point") = (F-32011, SRT, "End Diastole")</p> <p>(111031, DCM, "Image View") = (G-A19C, SRT, "Apical four chamber")</p> <p>(G-C036, SRT, "Measurement Method") = (125208, DCM, "Method of Disks, Single Plane")</p>
<p>RAESV(A-L A4C) Alias: RAESV (A-L A4C)</p>	<p>(GEU-106-106, 99GEMS, "Right Atrium End Systolic Volume")</p>	<p>(R-4089A, SRT, "Cardiac Cycle Point") = (109070, DCM, "End Systole")</p> <p>(111031, DCM, "Image View") = (G-A19C, SRT, "Apical four chamber")</p> <p>(G-C036, SRT, "Measurement Method") = (125205, DCM, "Area-Length Single Plane")</p>
<p>RAESV(MOD A4C) Alias: RAESV(MOD A4C)</p>	<p>(GEU-106-106, 99GEMS, "Right Atrium End Systolic Volume")</p>	<p>(R-4089A, SRT, "Cardiac Cycle Point") = (109070, DCM, "End Systole")</p> <p>(111031, DCM, "Image View") = (G-A19C, SRT, "Apical four chamber")</p> <p>(G-C036, SRT, "Measurement Method") = (125208, DCM, "Method of Disks, Single Plane")</p>
<p>RALs(A4C) Alias: RALs(A4C)</p>	<p>(29466-0, LN, "Right Atrium Superior-Inferior Dimension, 4-chamber view")</p>	<p>(R-4089A, SRT, "Cardiac Cycle Point") = (109070, DCM, "End Systole")</p> <p>(111031, DCM, "Image View") = (G-A19C,</p>

		SRT, “Apical four chamber”)
RAP Alias: RAP	(18070-3, LN, “Right Atrium Systolic Pressure”)	

Section Aortic Valve

GEU Parameter ID (and corresponding alias)	Base Measurement Concept Name	Concept or Acquisition Context Modifier
2D/AVA/AV Diam Alias: AV Diam	(G-038F, SRT, “Cardiovascular Orifice Diameter”)	(G-C048, SRT, “Direction of Flow”) = (R-42047, SRT, “Antegrade Flow”) = (G-0373, SRT, “Image Mode”) = (G-03A2, SRT, “2D mode”) or (R-409E2, SRT, “Doppler Color Flow”) depending on scan mode
AV Dec Time Alias: AV Dec Time	(20217-6, LN, “Deceleration Time”)	(G-C048, SRT, “Direction of Flow”) = (R-42047, SRT, “Antegrade Flow”)
AV Dec Slope Alias: AV Dec Slope	(20216-8, LN, “Deceleration Slope”)	(G-C048, SRT, “Direction of Flow”) = (R-42047, SRT, “Antegrade Flow”)
PISA/AR/RF Alias: AR RF	(G-0390, SRT, “Regurgitant Fraction”)	(G-C036, SRT, “Measurement Method”) = (125216, DCM, “Proximal Isovelocity Surface Area”)
MM/AV Diam Alias: AV Diam	(G-038F, SRT, “Cardiovascular Orifice Diameter”)	(G-C048, SRT, “Direction of Flow”) = (R-42047, SRT, “Antegrade Flow”) = (G-0373, SRT, “Image Mode”) = (G-0394, SRT, “M mode”)
MM/%IVS Thck Alias: %IVS Thck	(18054-7, LN, “Interventricular Septum % Thickening”)	(G-0373, SRT, “Image Mode”) = (G-0394, SRT, “M mode”)
2D/AV Diam Alias: AV Diam	(G-038F, SRT, “Cardiovascular Orifice Diameter”)	(G-C048, SRT, “Direction of Flow”) = (R-42047, SRT, “Antegrade Flow”) = (G-0373, SRT, “Image Mode”) = (G-03A2, SRT, “2D mode”) or (R-409E2, SRT, “Doppler Color

		Flow”) depending on scan mode
<p>2D/AV Cusp Alias: AV Cusp</p>	<p>(17996-0, LN, “Aortic Valve Cusp Separation”)</p>	<p>(G-0373, SRT, “Image Mode”) = (G-03A2, SRT, “2D mode”) or (R-409E2, SRT, “Doppler Color Flow”) depending on scan mode</p>
<p>2D/LAX/Trans AVA diastole Alias: Trans AVA (d)</p>	<p>(G-038E, SRT, “Cardiovascular Orifice Area”)</p>	<p>(G-0373, SRT, “Image Mode”) = (G-03A2, SRT, “2D mode”) or (R-409E2, SRT, “Doppler Color Flow”) depending on scan mode (R-4089A, SRT, “Cardiac Cycle Point”) = (F-32010, SRT, “Diastole”)</p>
<p>2D/LAX/Trans AVA systole Alias: Trans AVA (s)</p>	<p>(G-038E, SRT, “Cardiovascular Orifice Area”)</p>	<p>(G-0373, SRT, “Image Mode”) = (G-03A2, SRT, “2D mode”) or (R-409E2, SRT, “Doppler Color Flow”) depending on scan mode (R-4089A, SRT, “Cardiac Cycle Point”) = (F-32020, SRT, “Systole”)</p>
<p>2D/SAX/Trans AVA diastole Alias: Trans AVA (d)</p>	<p>(G-038E, SRT, “Cardiovascular Orifice Area”)</p>	<p>(G-0373, SRT, “Image Mode”) = (G-03A2, SRT, “2D mode”) or (R-409E2, SRT, “Doppler Color Flow”) depending on scan mode (R-4089A, SRT, “Cardiac Cycle Point”) = (F-32010, SRT, “Diastole”)</p>
<p>2D/SAX/Trans AVA systole Alias: Trans AVA (s)</p>	<p>(G-038E, SRT, “Cardiovascular Orifice Area”)</p>	<p>(G-0373, SRT, “Image Mode”) = (G-03A2, SRT, “2D mode”) or (R-409E2, SRT, “Doppler Color Flow”) depending on scan mode (R-4089A, SRT, “Cardiac Cycle Point”) = (F-32020, SRT, “Systole”)</p>
<p>2D/AVA Planimetry Alias: AVA Planimetry</p>	<p>(G-038E, SRT, “Cardiovascular Orifice Area”)</p>	<p>(G-C048, SRT, “Direction of Flow”) = (R-42047, SRT, “Antegrade Flow”) (G-0373, SRT, “Image Mode”) = (G-03A2, SRT, “2D mode”) or (R-409E2, SRT, “Doppler Color Flow”) depending on scan mode (G-C036, SRT, “Measurement Method”) = (125220, DCM, “Planimetry”)</p>
<p>2D/AV Area</p>	<p>(G-038E, SRT,</p>	<p>(G-C048, SRT, “Direction of</p>

<p>Alias: AV Area</p>	<p>“Cardiovascular Orifice Area”)</p>	<p>Flow”) = (R-42047, SRT, “Antegrade Flow”) (G-0373, SRT, “Image Mode”) = (G-03A2, SRT, “2D mode”) or (R-409E2, SRT, “Doppler Color Flow”) depending on scan mode</p>
<p>MM/AV Cusp Alias: AV Cusp</p>	<p>(17996-0, LN, “Aortic Valve Cusp Separation”)</p>	<p>(G-0373, SRT, «Image Mode») = (G-0394, SRT, «M mode»)</p>
<p>AV Vmax Alias: AV Vmax</p>	<p>(11726-7, LN, “Peak Velocity”)</p>	<p>(G-C048, SRT, “Direction of Flow”) = (R-42047, SRT, “Antegrade Flow”)</p>
<p>AV Vmax P Alias: AV Vmax</p>	<p>(11726-7, LN, “Peak Velocity”)</p>	<p>(G-C048, SRT, “Direction of Flow”) = (R-42047, SRT, “Antegrade Flow”)</p>
<p>AV maxPG Alias: AV maxPG</p>	<p>(20247-3, LN, “Peak Gradient”)</p>	<p>(G-C048, SRT, “Direction of Flow”) = (R-42047, SRT, “Antegrade Flow”)</p>
<p>AV Vmean Alias: AV Vmean</p>	<p>(20352-1, LN, “Mean Velocity”)</p>	<p>(G-C048, SRT, “Direction of Flow”) = (R-42047, SRT, “Antegrade Flow”)</p>
<p>AV meanPG Alias: AV meanPG</p>	<p>(20256-4, LN, “Mean Gradient”)</p>	<p>(G-C048, SRT, “Direction of Flow”) = (R-42047, SRT, “Antegrade Flow”)</p>
<p>AV Acc Time Alias: AV AccT</p>	<p>(20168-1, LN, “Acceleration Time”)</p>	<p>(G-C048, SRT, “Direction of Flow”) = (R-42047, SRT, “Antegrade Flow”) (G-0373, SRT, “Image Mode”) = (R-409E3, SRT, “Doppler Continuous Wave”)</p>
<p>AV VTI Alias: AV VTI</p>	<p>(20354-7, LN, “Velocity Time Integral”)</p>	<p>(G-C048, SRT, “Direction of Flow”) = (R-42047, SRT, “Antegrade Flow”)</p>
<p>AV Env. Ti Alias: AV Env. Ti</p>	<p>(GEU-106-0080, 99GEMS, “Time duration of the VTI trace on Aortic Valve”)</p>	<p>(G-0373, SRT, «Image Mode») = (R-409E4, SRT, «Doppler Pulsed») (G-C048, SRT, “Direction of Flow”) = (R-42047, SRT, “Antegrade Flow”)</p>

<p>AVA (VTI) Alias: AVA (VTI)</p>	<p>(G-038E, SRT, “Cardiovascular Orifice Area”)</p>	<p>(G-C048, SRT, “Direction of Flow”) = (R-42047, SRT, “Antegrade Flow”) (G-C036, SRT, “Measurement Method”) = (125215, DCM, “Continuity Equation by Velocity Time Integral”)</p>
<p>AVA (Vmax) Alias: AVA Vmax</p>	<p>(G-038E, SRT, “Cardiovascular Orifice Area”)</p>	<p>(G-C048, SRT, “Direction of Flow”) = (R-42047, SRT, “Antegrade Flow”) (G-C036, SRT, “Measurement Method”) = (125214, DCM, “Continuity Equation by Peak Velocity”)</p>
<p>AVA (Vmax)2 Alias: AVA Vmax, Pt</p>	<p>(G-038E, SRT, “Cardiovascular Orifice Area”)</p>	<p>(G-C048, SRT, “Direction of Flow”) = (R-42047, SRT, “Antegrade Flow”) (G-C036, SRT, “Measurement Method”) = (125214, DCM, “Continuity Equation by Peak Velocity”)</p>
<p>AVA (Vmax)P Alias: AVA Vmax, Pt</p>	<p>(G-038E, SRT, “Cardiovascular Orifice Area”)</p>	<p>(G-C048, SRT, “Direction of Flow”) = (R-42047, SRT, “Antegrade Flow”) (G-C036, SRT, “Measurement Method”) = (125214, DCM, “Continuity Equation by Peak Velocity”)</p>
<p>AVA (Vmax)P2 Alias: AVA Vmax</p>	<p>(G-038E, SRT, “Cardiovascular Orifice Area”)</p>	<p>(G-C048, SRT, “Direction of Flow”) = (R-42047, SRT, “Antegrade Flow”) (G-C036, SRT, “Measurement Method”) = (125214, DCM, “Continuity Equation by Peak Velocity”)</p>
<p>AV SV Alias: AV SV</p>	<p>(F-32120, SRT, “Stroke Volume”)</p>	<p>(G-C0E3, SRT, «Finding Site») = (T-42000, SRT, «Aorta»)</p>
<p>AV HR Alias: HR</p>	<p>(8867-4, LN, “Heart rate”)</p>	
<p>AV SI</p>	<p>(F-00078, SRT, “Stroke Index”)</p>	<p>(G-C0E3, SRT, «Finding Site») = (T-42000, SRT, «Aorta»)</p>

Alias: AV SI		
AV Time To Peak Alias: AV Time to Peak	(GEU-106-0006, 99GEMS, "Time to Peak")	
AV CO Alias: AV CO	(F-32100, SRT, "Cardiac Output")	(G-C0E3, SRT, «Finding Site») = (T-42000, SRT, «Aorta»)
AV CI Alias: AV CI	(F-32110, SRT, "Cardiac Index")	(G-C0E3, SRT, «Finding Site») = (T-42000, SRT, «Aorta»)
AV Acc Slope Alias: AV Acc Slope	(20167-3, LN, "Acceleration Slope")	(G-C048, SRT, "Direction of Flow") = (R-42047, SRT, "Antegrade Flow") (G-0373, SRT, "Image Mode") = (R-409E3, SRT, "Doppler Continuous Wave")
AVET Alias: AVET	(18041-4, LN, "Aortic Valve Ejection Time")	(G-0373, SRT, "Image Mode") = (R-409E3, SRT, "Doppler Continuous Wave")
AV Acc Time/ET Ratio Alias: AV Acc Time/ET	(G-0382, SRT, "Ratio of Aortic Valve Acceleration Time to Ejection Time")	(G-0373, SRT, "Image Mode") = (R-409E3, SRT, "Doppler Continuous Wave")
AV dp/dt Alias: AV dp dt	(59120-6, LN, "Aortic valve antegrade dp/dt [pressure rate] by US")	(G-C048, SRT, "Direction of Flow") = (R-42047, SRT, "Antegrade Flow")
AR PHT Alias: AR PHT	(20280-4, LN, "Pressure Half-Time")	(G-C048, SRT, "Direction of Flow") = (R-42E61, SRT, "Regurgitant Flow")
AR Dec Time Alias: AR Dec Time	(20217-6, LN, "Deceleration Time")	(G-C048, SRT, "Direction of Flow") = (R-42E61, SRT, "Regurgitant Flow")
AR Dec Slope Alias: AR Dec Slope	(20216-8, LN, "Deceleration Slope")	(G-C048, SRT, "Direction of Flow") = (R-42E61, SRT, "Regurgitant Flow")
AR Vmax	(11726-7, LN, "Peak Velocity")	(G-C048, SRT, "Direction of Flow") = (R-42E61, SRT,

Alias: AR Vmax		“Regurgitant Flow”)
AR maxPG Alias: AR maxPG	(20247-3, LN, “Peak Gradient”)	(G-C048, SRT, “Direction of Flow”) = (R-42E61, SRT, “Regurgitant Flow”)
AR Env. Ti Alias: AR Env. Ti	(GEU-106-0082, 99GEMS, “Time duration of the VTI trace on Aortic Regurgitant flow”)	(G-0373, SRT, «Image Mode») = (R-409E4, SRT, «Doppler Pulsed») (G-C048, SRT, “Direction of Flow”) = (R-42E61, SRT, “Regurgitant Flow”)
AR HR Alias: AR HR	(8867-4, LN, “Heart rate”)	(G-0373, SRT, «Image Mode») = (R-409E4, SRT, «Doppler Pulsed») (G-C048, SRT, “Direction of Flow”) = (R-42E61, SRT, “Regurgitant Flow”)
Arend Vmax Alias: Arend Vmax	(11726-7, LN, “Peak Velocity”)	(G-C048, SRT, “Direction of Flow”) = (R-42E61, SRT, “Regurgitant Flow”) (R-4089A, SRT, “Cardiac Cycle Point”) = (109022, DCM, “End Diastole”)
Arend maxPG Alias: Arend PG	(20247-3, LN, “Peak Gradient”)	(G-C048, SRT, “Direction of Flow”) = (R-42E61, SRT, “Regurgitant Flow”) (R-4089A, SRT, “Cardiac Cycle Point”) = (109022, DCM, “End Diastole”)
AR Vmean Alias: AR Vmean	(20352-1, LN, “Mean Velocity”)	(G-C048, SRT, “Direction of Flow”) = (R-42E61, SRT, “Regurgitant Flow”)
AR meanPG Alias: AR meanPG	(20256-4, LN, “Mean Gradient”)	(G-C048, SRT, “Direction of Flow”) = (R-42E61, SRT, “Regurgitant Flow”)
AR VTI Alias: AR VTI	(20354-7, LN, “Velocity Time Integral”)	(G-C048, SRT, “Direction of Flow”) = (R-42E61, SRT, “Regurgitant Flow”)
AR dp/dt Alias: AR dp/dt	(59120-6, LN, “Aortic regurgitant dp/dt US pressure by rate”)	(G-0373, SRT, «Image Mode») = (R-409E4, SRT, «Doppler Pulsed») (G-C048, SRT, “Direction of

		Flow”) = (R-42E61, SRT, “Regurgitant Flow”)
PISA/AR/Flow Alias: AR Flow	(34141-2, LN, “Peak Instantaneous Flow Rate”)	(G-C048, SRT, “Direction of Flow”) = (R-42E61, SRT, “Regurgitant Flow”) (G-C036, SRT, “Measurement Method”) = (125216, DCM, “Proximal Isovelocity Surface Area”)
PISA/AR/Radius Alias: AR Rad	(GEU-106-0004, 99GEMS, “Flow Radius”)	(G-C048, SRT, “Direction of Flow”) = (R-42E61, SRT, “Regurgitant Flow”) (G-C036, SRT, “Measurement Method”) = (125216, DCM, “Proximal Isovelocity Surface Area”)
PISA/AR/Velocity Alias: AR Als.Vel	(GEU-106-0005, 99GEMS, “Alias Velocity”)	(G-C048, SRT, “Direction of Flow”) = (R-42E61, SRT, “Regurgitant Flow”) (G-C036, SRT, “Measurement Method”) = (125216, DCM, “Proximal Isovelocity Surface Area”)
PISA/AR/Vmax Alias: AR Vmax	(11726-7, LN, “Peak Velocity”)	(G-C048, SRT, “Direction of Flow”) = (R-42E61, SRT, “Regurgitant Flow”) (G-C036, SRT, “Measurement Method”) = (125216, DCM, “Proximal Isovelocity Surface Area”)
PISA/AR/VTI Alias: AR VTI	(20354-7, LN, “Velocity Time Integral”)	(G-C048, SRT, “Direction of Flow”) = (R-42E61, SRT, “Regurgitant Flow”) (G-C036, SRT, “Measurement Method”) = (125216, DCM, “Proximal Isovelocity Surface Area”)
PISA/AR/ERO Alias: AR ERO	(G-038E, SRT, “Cardiovascular Orifice Area”)	(G-C048, SRT, “Direction of Flow”) = (R-42E61, SRT, “Regurgitant Flow”) (G-C036, SRT, “Measurement Method”) = (125216, DCM, “Proximal Isovelocity Surface Area”)

<p>PISA/AR/RV Alias: AR RV</p>	<p>(33878-0, LN, "Volume Flow")</p>	<p>(G-C048, SRT, "Direction of Flow") = (R-42E61, SRT, "Regurgitant Flow") (G-C036, SRT, "Measurement Method") = (125216, DCM, "Proximal Isovelocity Surface Area")</p>
<p>2D/AV Annulus Diam Alias: AV Annulus Diam</p>	<p>(79940-3, LN, "Aortic valve annulus Diameter at end systole by US 2D")</p>	
<p>AA_DIAMETER(4D) Alias: AA Diameter 4D</p>	<p>(G-038F, SRT, "Cardiovascular Orifice Diameter")</p>	<p>(G-C0E3, SRT, "Finding Site") = (T-35410, SRT, "Aortic Valve Ring") (G-C036, SRT, "Measurement Method") = (GEU-106-0098, 99GEMS, "4DautoAVQ quantification tool")</p>
<p>AA_AREA(4D) Alias: AA Area 4D</p>	<p>(G-038E, SRT, "Cardiovascular Orifice Area")</p>	<p>(G-C036, SRT, "Measurement Method") = (GEU-106-0098, 99GEMS, "4DautoAVQ quantification tool")</p>
<p>AA_CIRCUMFERENCE(4D) Alias: AA Circ 4D</p>	<p>(GEU-106-0098, 99GEMS, "Aortic Annulus Circumference on 4D image")</p>	<p>(G-C036, SRT, "Measurement Method") = (GEU-106-0098, 99GEMS, "4DautoAVQ quantification tool")</p>
<p>AA_MAX_DIAMETER(4D) Alias: AA Max Dia 4D</p>	<p>(GEU-106-0099, 99GEMS, "Aortic Annulus major semi-axis from ellipse fit on 4D image")</p>	<p>(G-C036, SRT, "Measurement Method") = (GEU-106-0098, 99GEMS, "4DautoAVQ quantification tool")</p>
<p>AA_MIN_DIAMTER(4D) Alias: AA Min Dia 4D</p>	<p>(GEU-106-0100, 99GEMS, "Aortic Annulus minor semi-axis from ellipse fit on 4D image")</p>	<p>(G-C036, SRT, "Measurement Method") = (GEU-106-0098, 99GEMS, "4DautoAVQ quantification tool")</p>

Section Mitral Valve

GEU Parameter ID (and corresponding alias)	Base Measurement Concept Name	Concept or Acquisition Context Modifier
--	-------------------------------	---

<p>MV Reg Frac Alias: MV Reg Frac</p>	<p>(G-0390, SRT, "Regurgitant Fraction")</p>	
<p>MR Acc Slope Alias: MR Acc Slope</p>	<p>(20167-3, LN, "Acceleration Slope")</p>	<p>(G-C048, SRT, "Direction of Flow") = (R-42E61, SRT, "Regurgitant Flow")</p>
<p>MR dp/dt Alias: MR dp/dt</p>	<p>(18035-6, LN, "Mitral Regurgitation dP/dt derived from Mitral Reg. velocity")</p>	
<p>PISA/MR/RF Alias: MR RF</p>	<p>(G-0390, SRT, "Regurgitant Fraction")</p>	<p>(G-C036, SRT, "Measurement Method") = (125216, DCM, "Proximal Isovelocity Surface Area")</p>
<p>2D/MV Annulus Diam Alias: MV Ann Diam</p>	<p>(G-038F, SRT, "Cardiovascular Orifice Diameter")</p>	<p>(G-C0E3, SRT, "Finding Site") = (T-35313, SRT, "Mitral Annulus") (G-C048, SRT, "Direction of Flow") = (R-42047, SRT, "Antegrade Flow") (G-0373, SRT, "Image Mode") = (G-03A2, SRT, "2D mode") or (R-409E2, SRT, "Doppler Color Flow") depending on scan mode</p>
<p>2D/SAX/MVA Alias: MVA Planimetry</p>	<p>(G-038E, SRT, "Cardiovascular Orifice Area")</p>	<p>(G-C048, SRT, "Direction of Flow") = (R-42047, SRT, "Antegrade Flow") (G-0373, SRT, "Image Mode") = (G-03A2, SRT, "2D mode") or (R-409E2, SRT, "Doppler Color Flow") depending on scan mode (111031, DCM, "Image View") = (G-0397, SRT, "Parasternal short axis")</p>
<p>2D/MVA Planimetry Alias: MVA Planimetry</p>	<p>(G-038E, SRT, "Cardiovascular Orifice Area")</p>	<p>(G-C048, SRT, "Direction of Flow") = (R-42047, SRT, "Antegrade Flow") (G-0373, SRT, "Image Mode") = (G-03A2, SRT, "2D mode") or (R-409E2, SRT, "Doppler Color Flow") depending on scan mode (G-C036, SRT,</p>

		“Measurement Method”) = (125220, DCM, “Planimetry”)
<p>2D/MV Area</p> <p>Alias: MV Area</p>	<p>(G-038E, SRT, “Cardiovascular Orifice Area”)</p>	<p>(G-C048, SRT, “Direction of Flow”) = (R-42047, SRT, “Antegrade Flow”)</p> <p>(G-0373, SRT, “Image Mode”) = (G-03A2, SRT, “2D mode”) or (R-409E2, SRT, “Doppler Color Flow”) depending on scan mode</p>
<p>2D/EPSS</p> <p>Alias: EPSS</p>	<p>(GEU-106-0066, 99GEMS, “E-point Spetal separation in 2D”)</p>	<p>(G-0373, SRT, “Image Mode”) = (G-03A2, SRT, “2D mode”)</p>
<p>4DAutoMVQ/A-P_Diameter</p> <p>Alias: MV A-P Diam</p>	<p>(GEU-106-0036, 99GEMS, “MV antero-posterior diameter by 4Dauto MV quantification tool”)</p>	<p>(G-0373, SRT, “Image Mode”) = (125231, DCM, “3D mode”)</p> <p>(G-C036, SRT, “Measurement Method”) = (GEU-106-0037, 99GEMS, “4D auto MV quantification tool”)</p> <p>(111031, DCM, “Image View”) = (G-0395, SRT, “Apical long axis”)</p>
<p>4DAutoMVQ/PM-AL_Diameter</p> <p>Alias: MV PM-AL Diam</p>	<p>(GEU-106-0038, 99GEMS, “Mitral valve Diameter, medLat to AntPost hinge on commissural view”)</p>	<p>(G-0373, SRT, “Image Mode”) = (125231, DCM, “3D mode”)</p> <p>(G-C036, SRT, “Measurement Method”) = (GEU-106-0037, 99GEMS, “4D auto MV quantification tool”)</p> <p>(GEU-106-0039, 99GEMS, “MV commissural view”)</p>
<p>4DAutoMVQ/Annulus_Perimeter</p> <p>Alias: MV Annulus Perimeter</p>	<p>(GEU-106-0040, 99GEMS, “4D mitral annulus perimeter”)</p>	<p>(G-0373, SRT, “Image Mode”) = (125231, DCM, “3D mode”)</p> <p>(G-C036, SRT, “Measurement Method”) = (GEU-106-0037, 99GEMS, “4D auto MV quantification tool”)</p> <p>(T-35313, SRT, “Mitral Annulus”)</p>

<p>4DAutoMVQ/Annulus_Area_3D Alias: MV Annulus Area 3D</p>	<p>(GEU-106-0041, 99GEMS, “4D mitral annulus surface”)</p>	<p>(G-0373, SRT, “Image Mode”) = (125231, DCM, “3D mode”) (G-C036, SRT, “Measurement Method”) = (GEU-106-0037, 99GEMS, “4D auto MV quantification tool”) (T-35313, SRT, “Mitral Annulus”)</p>
<p>4DAutoMVQ/Tenting_Height Alias: MV Tenting Height</p>	<p>(GEU-106-0042, 99GEMS, “MV tenting height from 4D Aplax”)</p>	<p>(G-0373, SRT, “Image Mode”) = (125231, DCM, “3D mode”) (G-C036, SRT, “Measurement Method”) = (GEU-106-0037, 99GEMS, “4D auto MV quantification tool”) (111031, DCM, “Image View”) = (G-0395, SRT, “Apical long axis”)</p>
<p>4DAutoMVQ/Mitral-Aortic_Angle Alias: Mitral-Aortic Angle</p>	<p>(GEU-106-0043, 99GEMS, “Mitral-Aortic angle from 4D Aplax”)</p>	<p>(G-0373, SRT, “Image Mode”) = (125231, DCM, “3D mode”) (G-C036, SRT, “Measurement Method”) = (GEU-106-0037, 99GEMS, “4D auto MV quantification tool”) (111031, DCM, “Image View”) = (G-0395, SRT, “Apical long axis”)</p>
<p>4DAutoMVQ/Inter_Trigonal_Distance Alias: MV Inter-Trigonal Dist</p>	<p>(GEU-106-0044, 99GEMS, “Distance between mitral trigons”)</p>	<p>(G-0373, SRT, “Image Mode”) = (125231, DCM, “3D mode”) (G-C036, SRT, “Measurement Method”) = (GEU-106-0037, 99GEMS, “4D auto MV quantification tool”)</p>
<p>4DAutoMVQ/Annulus_Height Alias: MV Annulus Height</p>	<p>(GEU-106-0045, 99GEMS, “MV annulus height”)</p>	<p>(G-0373, SRT, “Image Mode”) = (125231, DCM, “3D mode”) (G-C036, SRT, “Measurement Method”) = (GEU-106-0037, 99GEMS, “4D auto MV quantification tool”)</p>

		tool”)
<p>4DAutoMVQ/Anterior_Leaflet_Length</p> <p>Alias: MV Ant Leaflet Len</p>	<p>(GEU-106-0046, 99GEMS, “Length of anterior MV leaflet from 4D Aplax”)</p>	<p>(G-0373, SRT, “Image Mode”) = (125231, DCM, “3D mode”)</p> <p>(G-C036, SRT, “Measurement Method”) = (GEU-106-0037, 99GEMS, “4D auto MV quantification tool”)</p> <p>(111031, DCM, “Image View”) = (G-0395, SRT, “Apical long axis”)</p> <p>(G-C0E3, SRT, “Finding Site”) = (T-35321, SRT, “Anterior Leaflet of Mitral Valve”)</p>
<p>4DAutoMVQ/Posterior_Leaflet_Length</p> <p>Alias: MV Post Leaflet Len</p>	<p>(GEU-106-0047, 99GEMS, “Length of posterior MV from 4D Aplax”)</p>	<p>(G-0373, SRT, “Image Mode”) = (125231, DCM, “3D mode”)</p> <p>(G-C036, SRT, “Measurement Method”) = (GEU-106-0037, 99GEMS, “4D auto MV quantification tool”)</p> <p>(111031, DCM, “Image View”) = (G-0395, SRT, “Apical long axis”)</p> <p>(G-C0E3, SRT, “Finding Site”) = (T-35322, SRT, “Posterior Leaflet of Mitral Valve”)</p>
<p>MV A VTI</p> <p>Alias: MV A VTI</p>	<p>(20354-7, LN, “Velocity Time Integral”)</p>	<p>(R-4089A, SRT, “Cardiac Cycle Point”) = (F-32030, SRT, “Atrial Systole”)</p>
<p>MV Dec Time</p> <p>Alias: MV DecT</p>	<p>(20217-6, LN, “Deceleration Time”)</p>	<p>(G-C048, SRT, “Direction of Flow”) = (R-42047, SRT, “Antegrade Flow”)</p>
<p>MV PHT</p> <p>Alias: MV PHT</p>	<p>(20280-4, LN, “Pressure Half-Time”)</p>	<p>(G-C048, SRT, “Direction of Flow”) = (R-42047, SRT, “Antegrade Flow”)</p>
<p>MV Dec Slope</p> <p>Alias: MV Dec Slope</p>	<p>(20216-8, LN, “Deceleration Slope”)</p>	<p>(G-C048, SRT, “Direction of Flow”) = (R-42047, SRT, “Antegrade Flow”)</p>
<p>MVA (PHT)</p>	<p>(G-038E, SRT,</p>	<p>(G-C048, SRT, “Direction of</p>

Alias: MVA By PHT	“Cardiovascular Orifice Area”)	Flow”) = (R-42047, SRT, “Antegrade Flow”) (G-C036, SRT, “Measurement Method”) = (125210, DCM, “Area by Pressure Half-Time”)
MVA (VTI) Alias: MVA (VTI)	(G-038E, SRT, “Cardiovascular Orifice Area”)	(G-C048, SRT, “Direction of Flow”) = (R-42047, SRT, “Antegrade Flow”) (G-C036, SRT, “Measurement Method”) = (125215, DCM, “Continuity Equation by Velocity Time Integral”)
MV meanPG Alias: MV meanPG	(20256-4, LN, “Mean Gradient”)	(G-C048, SRT, “Direction of Flow”) = (R-42047, SRT, “Antegrade Flow”)
MV Vmax Alias: MV Vmax	(11726-7, LN, “Peak Velocity”)	(G-C048, SRT, “Direction of Flow”) = (R-42047, SRT, “Antegrade Flow”)
MV Vmean Alias: MV Vmean	(20352-1, LN, “Mean Velocity”)	(G-C048, SRT, “Direction of Flow”) = (R-42047, SRT, “Antegrade Flow”)
MV maxPG Alias: MV maxPG	(20247-3, LN, “Peak Gradient”)	(G-C048, SRT, “Direction of Flow”) = (R-42047, SRT, “Antegrade Flow”)
MV VTI Alias: MV VTI	(20354-7, LN, “Velocity Time Integral”)	(G-C048, SRT, “Direction of Flow”) = (R-42047, SRT, “Antegrade Flow”)
MV Time To Peak Alias: MV Time to Peak	(GEU-106-0006, 99GEMS, “Time to Peak”)	
MV HR Alias: HR	(8867-4, LN, “Heart rate”)	
MV SV Alias: MV SV	(F-32120, SRT, “Stroke Volume”)	(G-C0E3, SRT, «Finding Site») = (T-35300, SRT, «Mitral Valve»)
MV SI	(F-00078, SRT, “Stroke	(G-C0E3, SRT, «Finding

Alias: MV SI	Index”)	Site») = (T-35300, SRT, «Mitral Valve»)
MV CO Alias: MV CO	(F-32100, SRT, “Cardiac Output”)	(G-C0E3, SRT, «Finding Site») = (T-35300, SRT, «Mitral Valve»)
MV CI Alias: MV CI	(F-32110, SRT, “Cardiac Index”)	(G-C0E3, SRT, «Finding Site») = (T-35300, SRT, «Mitral Valve»)
MV E Env.Ti Alias: MV E Env. Ti	(GEU-106-0076, 99GEMS, “Time duration of the VTI trace on Mitral Valve E-wave”)	(G-0373, SRT, «Image Mode») = (R-409E4, SRT, «Doppler Pulsed»)
MV A Env. Ti Alias: MV A Env. Ti	(GEU-106-0077, 99GEMS, “Time duration of the VTI trace on Mitral Valve A-wave”)	(G-0373, SRT, «Image Mode») = (R-409E4, SRT, «Doppler Pulsed»)
MV Env. Ti Alias: MV Env. Ti	(GEU-106-0078, 99GEMS, “Time duration of the VTI trace on Mitral Valve”)	(G-0373, SRT, «Image Mode») = (R-409E4, SRT, «Doppler Pulsed») (G-C048, SRT, “Direction of Flow”) = (R-42047, SRT, “Antegrade Flow”)
MR Env. Ti Alias: MR Env. Ti	(GEU-106-0079, 99GEMS, “Time duration of the VTI trace on Mitral Regurgitant flow”)	(G-0373, SRT, «Image Mode») = (R-409E4, SRT, «Doppler Pulsed») (G-C048, SRT, “Direction of Flow”) = (R-42E61, SRT, “Regurgitant Flow”)
MVET Alias: MVET	(GEU-106-0069, 99GEMS, “Mitral Valve Ejection Time”)	(G-0373, SRT, «Image Mode») = (R-409E4, SRT, «Doppler Pulsed»)
MV Eann Velocity Alias: MV Eann Velocity	(18037-2, LN, “Mitral Valve E-Wave Peak Velocity”)	(G-C0E3, SRT, “Finding Site”) = (T-35313, SRT, “Mitral Annulus”)
MV E/A Ratio Alias: MV E/A Ratio	(18038-0, LN, “Mitral Valve E to A Ratio”)	

<p>MV Acc Time/MV Dec Time Alias: MV AccT/DecT</p>	<p>(G-0386, SRT, «Mitral Valve AT/DT Ratio»)</p>	
<p>MV dp/dt Alias MV dp dt</p>	<p>(59120-6, LN, “Mitral valve antegrade dP/dt [pressure rate] by US”)</p>	<p>(G-C048, SRT, “Direction of Flow”) = (R-42047, SRT, “Antegrade Flow”)</p>
<p>MR Vmax Alias: MR Vmax</p>	<p>(11726-7, LN, “Peak Velocity”)</p>	<p>(G-C048, SRT, “Direction of Flow”) = (R-42E61, SRT, “Regurgitant Flow”)</p>
<p>MR meanPG Alias: MR meanPG</p>	<p>(20256-4, LN, “Mean Gradient”)</p>	<p>(G-C048, SRT, “Direction of Flow”) = (R-42E61, SRT, “Regurgitant Flow”)</p>
<p>MR Vmean Alias: MR Vmean</p>	<p>(20352-1, LN, “Mean Velocity”)</p>	<p>(G-C048, SRT, “Direction of Flow”) = (R-42E61, SRT, “Regurgitant Flow”)</p>
<p>MR maxPG Alias: MR maxPG</p>	<p>(20247-3, LN, “Peak Gradient”)</p>	<p>(G-C048, SRT, “Direction of Flow”) = (R-42E61, SRT, “Regurgitant Flow”)</p>
<p>MR VTI Alias: MR VTI</p>	<p>(20354-7, LN, “Velocity Time Integral”)</p>	<p>(G-C048, SRT, “Direction of Flow”) = (R-42E61, SRT, “Regurgitant Flow”)</p>
<p>MCO Alias: MCO</p>	<p>(G-0387, SRT, “Mitral Valve Closure to Opening Time”)</p>	<p>(G-0373, SRT, “Image Mode”) = (R-409E3, SRT, “Doppler Continuous Wave”)</p>
<p>PISA/MR/Flow Alias: MR Flow</p>	<p>(34141-2, LN, “Peak Instantaneous Flow Rate”)</p>	<p>(G-C048, SRT, “Direction of Flow”) = (R-42E61, SRT, “Regurgitant Flow”) (G-C036, SRT, “Measurement Method”) = (125216, DCM, “Proximal Isovelocity Surface Area”)</p>
<p>PISA/MR/Radius Alias: MR Rad</p>	<p>(GEU-106-0004, 99GEMS, “Flow Radius”)</p>	<p>(G-C048, SRT, “Direction of Flow”) = (R-42E61, SRT, “Regurgitant Flow”) (G-C036, SRT, “Measurement Method”) = (125216, DCM, “Proximal Isovelocity Surface Area”)</p>
<p>PISA/MR/Velocity</p>	<p>(GEU-106-0005, 99GEMS,</p>	<p>(G-C048, SRT, “Direction of</p>

Alias: MR Als.Vel	“Alias Velocity”)	Flow”) = (R-42E61, SRT, “Regurgitant Flow”) (G-C036, SRT, “Measurement Method”) = (125216, DCM, “Proximal Isovelocity Surface Area”)
PISA/MR/Vmax Alias: MR Vmax	(11726-7, LN, “Peak Velocity”)	(G-C048, SRT, “Direction of Flow”) = (R-42E61, SRT, “Regurgitant Flow”) (G-C036, SRT, “Measurement Method”) = (125216, DCM, “Proximal Isovelocity Surface Area”)
PISA/MR/VTI Alias: MR VTI	(20354-7, LN, “Velocity Time Integral”)	(G-C048, SRT, “Direction of Flow”) = (R-42E61, SRT, “Regurgitant Flow”) (G-C036, SRT, “Measurement Method”) = (125216, DCM, “Proximal Isovelocity Surface Area”)
PISA/MR/ERO Alias: MR ERO	(G-038E, SRT, “Cardiovascular Orifice Area”)	(G-C048, SRT, “Direction of Flow”) = (R-42E61, SRT, “Regurgitant Flow”) (G-C036, SRT, “Measurement Method”) = (125216, DCM, “Proximal Isovelocity Surface Area”)
PISA/MR/RV Alias: MR RV	(33878-0, LN, “Volume Flow”)	(G-C048, SRT, “Direction of Flow”) = (R-42E61, SRT, “Regurgitant Flow”) (G-C036, SRT, “Measurement Method”) = (125216, DCM, “Proximal Isovelocity Surface Area”)
MV Eprime Velocity Alias: E’	(59133-9, LN, “Peak Tissue Velocity”)	(G-C0E3, SRT, “Finding Site”) = (T-35313, SRT, “Mitral Annulus”) (R-4089A, SRT, “Cardiac Cycle Point”) = (R-40B1B, SRT, “Early Diastole”)
MV E/Eprime Ratio/Calc Alias: E/E’	(59111-5, LN, “E Velocity to Annulus E Velocity Ratio”)	

<p>MV E/A Ratio/Calc</p> <p>Alias: E/A Ratio</p>	<p>(18038-0, LN, "Mitral Valve E to A Ratio")</p>	
<p>MV Medial Eprime Velocity</p> <p>Alias: E' Sept</p>	<p>(59133-9, LN, "Peak Tissue Velocity")</p>	<p>(G-C0E3, SRT, "Finding Site") = (G-0391, SRT, "Medial Mitral Annulus")</p> <p>(R-4089A, SRT, "Cardiac Cycle Point") = (R-40B1B, SRT, "Early Diastole")</p>
<p>MV Medial E/Eprime Ratio/Calc</p> <p>Alias: E/E' Sept</p>	<p>(59111-5, LN, "E Velocity to Annulus E Velocity Ratio")</p>	<p>(G-C0E3, SRT, "Finding Site") = (G-0391, SRT, "Medial Mitral Annulus")</p>
<p>MV Lateral Eprime Velocity</p> <p>Alias: E' Lat</p>	<p>(59133-9, LN, "Peak Tissue Velocity")</p>	<p>(G-C0E3, SRT, "Finding Site") = (G-0392, SRT, "Lateral Mitral Annulus")</p> <p>(R-4089A, SRT, "Cardiac Cycle Point") = (R-40B1B, SRT, "Early Diastole")</p>
<p>MV Lateral E/Eprime Ratio/Calc</p> <p>Alias: E/E' Lat</p>	<p>(59111-5, LN, "E Velocity to Annulus E Velocity Ratio")</p>	<p>(G-C0E3, SRT, "Finding Site") = (G-0392, SRT, "Lateral Mitral Annulus")</p>
<p>Medial E'/2 + Lateral E'/2 (calc Avg)</p> <p>Alias: E' Avg</p>	<p>(GEU-106-0031, 99GEMS, "Average Annulus E Velocity")</p>	<p>(R-4089A, SRT, "Cardiac Cycle Point") = (R-40B1B, SRT, "Early Diastole")</p>
<p>E/(Medial E'/2 + Lateral E'/2)</p> <p>Alias: E/E' Avg</p>	<p>(GEU-106-0032, 99GEMS, "E Velocity to Average Annulus E Velocity")</p>	
<p>MM/MAPSE</p> <p>Alias: MAPSE</p>	<p>(GEU-106-0035, 99GEMS, "Mitral Annular Plane Systolic Excursion (MAPSE)")</p>	<p>(G-C0E3, SRT, "Finding Site") = (T-35313, SRT, "Mitral Annulus")</p>

<p>MM/MV CE Dist Alias: MV CE Dist</p>	<p>(59122-2, LN, "Valve C-E distance US")</p>	<p>(G-0373, SRT, "Image Mode") = (G-0394, SRT, "M mode")</p>
<p>MM/MV D-E Excursion Alias: MV D-E Excursion</p>	<p>(17997-8, LN, "Mitral Valve D-E Excursion")</p>	<p>(G-0373, SRT, "Image Mode") = (G-0394, SRT, "M mode")</p>
<p>MM/MV D-E Slope Alias: MV D-E Slope</p>	<p>(59127-1, LN, "Valve D-E slope")</p>	<p>(G-0373, SRT, "Image Mode") = (G-0394, SRT, "M mode")</p>

Section Pulmonic Valve

GEU Parameter ID (and corresponding alias)	Base Measurement Concept Name	Concept or Acquisition Context Modifier
<p>2D/PV Annulus Diam Alias: PV Ann Diam</p>	<p>(G-038F, SRT, "Cardiovascular Orifice Diameter")</p>	<p>(G-C048, SRT, "Direction of Flow") = (R-42047, SRT, "Antegrade Flow") (G-0373, SRT, "Image Mode") = (G-03A2, SRT, "2D mode") or (R-409E2, SRT, "Doppler Color Flow") depending on scan mode</p>
<p>2D/PV Area Alias: PV Area</p>	<p>(G-038E, SRT, "Cardiovascular Orifice Area")</p>	<p>(G-C048, SRT, "Direction of Flow") = (R-42047, SRT, "Antegrade Flow") (G-0373, SRT, "Image Mode") = (G-03A2, SRT, "2D mode") or (R-409E2, SRT, "Doppler Color Flow") depending on scan mode</p>
<p>MM/Q-to-PV close Alias: Q-to-PV close</p>	<p>(20295-2, LN, "Time from Q wave to Pulmonic Valve Closes")</p>	<p>(G-0373, SRT, «Image Mode») = (G-0394, SRT, «M mode»)</p>
<p>PV Vmax Alias: PV Vmax</p>	<p>(11726-7, LN, "Peak Velocity")</p>	<p>(G-C048, SRT, "Direction of Flow") = (R-42047, SRT, "Antegrade Flow")</p>

<p>PV Vmax P Alias: PV Vmax</p>	<p>(11726-7, LN, "Peak Velocity")</p>	<p>(G-C048, SRT, "Direction of Flow") = (R-42047, SRT, "Antegrade Flow")</p>
<p>PV maxPG Alias: PV maxPG</p>	<p>(20247-3, LN, "Peak Gradient")</p>	<p>(G-C048, SRT, "Direction of Flow") = (R-42047, SRT, "Antegrade Flow")</p>
<p>PV Vmean Alias: PV Vmean</p>	<p>(20352-1, LN, "Mean Velocity")</p>	<p>(G-C048, SRT, "Direction of Flow") = (R-42047, SRT, "Antegrade Flow")</p>
<p>PV meanPG Alias: PV meanPG</p>	<p>(20256-4, LN, "Mean Gradient")</p>	<p>(G-C048, SRT, "Direction of Flow") = (R-42047, SRT, "Antegrade Flow")</p>
<p>PV Acc Time Alias: PV AccT</p>	<p>(20168-1, LN, "Acceleration Time")</p>	<p>(G-C048, SRT, "Direction of Flow") = (R-42047, SRT, "Antegrade Flow")</p>
<p>PV VTI Alias: PV VTI</p>	<p>(20354-7, LN, "Velocity Time Integral")</p>	<p>(G-C048, SRT, "Direction of Flow") = (R-42047, SRT, "Antegrade Flow")</p>
<p>PV Env.Ti Alias: PV Env.Ti</p>	<p>(GEU-106-0086, "Time duration of the VTI trace on Pulmonic Valve")</p>	<p>(G-0373, SRT, «Image Mode») = (R-409E4, SRT, «Doppler Pulsed») (G-C048, SRT, "Direction of Flow") = (R-42047, SRT, "Antegrade Flow")</p>
<p>PVA (VTI) Alias: PVA (VTI)</p>	<p>(G-038E, SRT, "Cardiovascular Orifice Area")</p>	<p>(G-C048, SRT, "Direction of Flow") = (R-42047, SRT, "Antegrade Flow") (G-C036, SRT, "Measurement Method") = (125215, DCM, "Continuity Equation by Velocity Time Integral")</p>
<p>PVA (Vmax) Alias: PVA (Vmax)</p>	<p>(G-038E, SRT, "Cardiovascular Orifice Area")</p>	<p>(G-C048, SRT, "Direction of Flow") = (R-42047, SRT, "Antegrade Flow") (G-C036, SRT, "Measurement Method") = (125214, DCM, "Continuity Equation by Peak Velocity")</p>
<p>PVA (Vmax)P Alias: PVA (Vmax)</p>	<p>(G-038E, SRT, "Cardiovascular Orifice Area")</p>	<p>(G-C048, SRT, "Direction of Flow") = (R-42047, SRT, "Antegrade Flow") (G-C036, SRT, "Measurement Method") = (125214, DCM, "Continuity Equation by Peak Velocity")</p>

<p>PV HR Alias: HR</p>	<p>(8867-4, LN, “Heart rate”)</p>	
<p>PV SV Alias: PV SV</p>	<p>(F-32120, SRT, “Stroke Volume”)</p>	
<p>PV CO Alias: PV CO</p>	<p>(F-32100, SRT, “Cardiac Output”)</p>	
<p>PV SI Alias: PV SI</p>	<p>(F-00078, SRT, “Stroke Index”)</p>	
<p>PV CI Alias: PV CI</p>	<p>(F-32110, SRT, “Cardiac Index”)</p>	
<p>PV dp/dt Alias: PV dp/dt</p>	<p>(59120-6, LN, “Pulmonic valve antegrade dp/dt [pressure rate] by US”)</p>	<p>(G-0373, SRT, «Image Mode») = (R-409E4, SRT, «Doppler Pulsed») (G-C048, SRT, “Direction of Flow”) = (R-42047, SRT, “Antegrade Flow”)</p>
<p>PV Acc Slope Alias: PV Acc Slope</p>	<p>(20167-3, LN, “Acceleration Slope”)</p>	<p>(G-C048, SRT, “Direction of Flow”) = (R-42047, SRT, “Antegrade Flow”)</p>
<p>PVET Alias: PVET</p>	<p>(18042-2, LN, “Pulmonic Valve Ejection Time”)</p>	<p>(G-0373, SRT, “Image Mode”) = (R-409E3, SRT, “Doppler Continuous Wave”)</p>
<p>SD/Q-to-PV close Alias: Q-to-PV close</p>	<p>(20295-2, LN, “Time from Q wave to Pulmonic Valve Closes”)</p>	<p>(G-0373, SRT, «Image Mode») = (R-409E4, SRT, «Doppler Pulsed»)</p>
<p>PV Acc Time/ET Ratio Alias: PV AccT/ET</p>	<p>(G-0388, SRT, “Ratio of Pulmonic Valve Acceleration Time to Ejection Time”)</p>	
<p>PV Time To Peak Alias: PV Time to Peak</p>	<p>(GEU-106-0006, 99GEMS, “Time to Peak”)</p>	
<p>PR HR</p>	<p>(8867-4, LN, “Heart rate”)</p>	<p>(G-0373, SRT, «Image Mode») = (R-409E4, SRT, «Doppler Pulsed»)</p>

Alias: PR HR		(G-C048, SRT, "Direction of Flow") = (R-42E61, SRT, "Regurgitant Flow")
PR PHT Alias: PR PHT	(20280-4, LN, "Pressure Half-Time")	(G-C048, SRT, "Direction of Flow") = (R-42E61, SRT, "Regurgitant Flow")
PR Dec Time Alias: PR DecT	(20217-6, LN, "Deceleration Time")	(G-C048, SRT, "Direction of Flow") = (R-42E61, SRT, "Regurgitant Flow")
PR Dec Slope Alias: PR Dec Slope	(20216-8, LN, "Deceleration Slope")	(G-C048, SRT, "Direction of Flow") = (R-42E61, SRT, "Regurgitant Flow")
PR Vmax Alias: PR Vmax	(11726-7, LN, "Peak Velocity")	(G-C048, SRT, "Direction of Flow") = (R-42E61, SRT, "Regurgitant Flow")
PR maxPG Alias: PR maxPG	(20247-3, LN, "Peak Gradient")	(G-C048, SRT, "Direction of Flow") = (R-42E61, SRT, "Regurgitant Flow")
PR Vmean Alias: PR Vmean	(20352-1, LN, "Mean Velocity")	(G-C048, SRT, "Direction of Flow") = (R-42E61, SRT, "Regurgitant Flow")
PR meanPG Alias: PR meanPG	(20256-4, LN, "Mean Gradient")	(G-C048, SRT, "Direction of Flow") = (R-42E61, SRT, "Regurgitant Flow")
PR VTI Alias: PR VTI	(20354-7, LN, "Velocity Time Integral")	(G-C048, SRT, "Direction of Flow") = (R-42E61, SRT, "Regurgitant Flow")
PR Env.Ti Alias: PR Env.Ti	(GEU-106-0087, 99GEMS, "Time duration of the VTI trace on Pulmonic Regurgitant flow")	(G-0373, SRT, "Image Mode") = (R-409E4, SRT, "Doppler Pulsed") (G-C048, SRT, "Direction of Flow") = (R-42E61, SRT, "Regurgitant Flow")
PR dp/dt Alias: PR dp/dt	(59120-6, LN, "Pulmonic valve regurgitant dp/dt [pressure rate] by US")	(G-0373, SRT, "Image Mode") = (R-409E4, SRT, "Doppler Pulsed") or (G-0373, SRT, "Image Mode") = (R-409E3, SRT, "Doppler Continuous Wave") (G-C048, SRT, "Direction of Flow") = (R-42E61, SRT, "Regurgitant Flow")

<p>Prend Vmax Alias: Prend Vmax</p>	<p>(11726-7, LN, "Peak Velocity")</p>	<p>(G-C048, SRT, "Direction of Flow") = (R-42E61, SRT, "Regurgitant Flow") (R-4089A, SRT, "Cardiac Cycle Point") = (109022, DCM, "End Diastole")</p>
<p>Prend maxPG Alias: Prend PG</p>	<p>(20247-3, LN, "Peak Gradient")</p>	<p>(G-C048, SRT, "Direction of Flow") = (R-42E61, SRT, "Regurgitant Flow") (R-4089A, SRT, "Cardiac Cycle Point") = (109022, DCM, "End Diastole")</p>
<p>PISA/PR/Flow Alias: PR Flow</p>	<p>(34141-2, LN, "Peak Instantaneous Flow Rate")</p>	<p>(G-C048, SRT, "Direction of Flow") = (R-42E61, SRT, "Regurgitant Flow") (G-C036, SRT, "Measurement Method") = (125216, DCM, "Proximal Isovelocity Surface Area")</p>
<p>PISA/PR/Radius Alias: PR Rad</p>	<p>(GEU-106-0004, 99GEMS, "Flow Radius")</p>	<p>(G-C048, SRT, "Direction of Flow") = (R-42E61, SRT, "Regurgitant Flow") (G-C036, SRT, "Measurement Method") = (125216, DCM, "Proximal Isovelocity Surface Area")</p>
<p>PISA/PR/Velocity Alias: PR Als.Vel</p>	<p>(GEU-106-0005, 99GEMS, "Alias Velocity")</p>	<p>(G-C048, SRT, "Direction of Flow") = (R-42E61, SRT, "Regurgitant Flow") (G-C036, SRT, "Measurement Method") = (125216, DCM, "Proximal Isovelocity Surface Area")</p>
<p>PISA/PR/Vmax Alias: PR Vmax</p>	<p>(11726-7, LN, "Peak Velocity")</p>	<p>(G-C048, SRT, "Direction of Flow") = (R-42E61, SRT, "Regurgitant Flow") (G-C036, SRT, "Measurement Method") = (125216, DCM, "Proximal Isovelocity Surface Area")</p>
<p>PISA/PR/VTI Alias: PR VTI</p>	<p>(20354-7, LN, "Velocity Time Integral")</p>	<p>(G-C048, SRT, "Direction of Flow") = (R-42E61, SRT, "Regurgitant Flow") (G-C036, SRT, "Measurement Method") = (125216, DCM, "Proximal Isovelocity Surface Area")</p>
<p>PISA/PR/ERO Alias: PR ERO</p>	<p>(G-038E, SRT, "Cardiovascular Orifice Area")</p>	<p>(G-C048, SRT, "Direction of Flow") = (R-42E61, SRT, "Regurgitant Flow") (G-C036, SRT, "Measurement Method") = (125216, DCM, "Proximal Isovelocity Surface Area")</p>
<p>PISA/PR/RV Alias: PR RV</p>	<p>(33878-0, LN, "Volume Flow")</p>	<p>(G-C048, SRT, "Direction of Flow") = (R-42E61, SRT, "Regurgitant Flow") (G-C036, SRT, "Measurement Method") = (125216, DCM, "Proximal Isovelocity Surface Area")</p>

		Surface Area")
--	--	----------------

Section Tricuspid Valve

GEU Parameter ID (and corresponding alias)	Base Measurement Concept Name	Concept or Acquisition Context Modifier
2D/TVA Planimetry Alias: TVA Planimetry	(G-038E, SRT, "Cardiovascular Orifice Area")	(G-C048, SRT, "Direction of Flow") = (R-42047, SRT, "Antegrade Flow") (G-0373, SRT, "Image Mode") = (G-03A2, SRT, "2D mode") or (R-409E2, SRT, "Doppler Color Flow") depending on scan mode (G-C036, SRT, "Measurement Method") = (125220, DCM, "Planimetry")
2D/TV Annulus Diam Alias: TV Ann Diam	(G-038F, SRT, "Cardiovascular Orifice Diameter")	(G-C0E3, SRT, "Finding Site") = (T-35111, SRT, "Tricuspid Annulus") (G-C048, SRT, "Direction of Flow") = (R-42047, SRT, "Antegrade Flow") (G-0373, SRT, "Image Mode") = (G-03A2, SRT, "2D mode") or (R-409E2, SRT, "Doppler Color Flow") depending on scan mode
2D/TV Area Alias: TV Area	(G-038E, SRT, "Cardiovascular Orifice Area")	(G-C048, SRT, "Direction of Flow") = (R-42047, SRT, "Antegrade Flow") (G-0373, SRT, "Image Mode") = (G-03A2, SRT, "2D mode") or (R-409E2, SRT, "Doppler Color Flow") depending on scan mode
MM/Q-to-TV open Alias: Q-to-TV open	(20296-0, LN, "Time from Q wave to Tricuspid Valve Opens")	(G-0373, SRT, «Image Mode») = (G-0394, SRT, «M mode»)
TV Acc Time Alias: TV AccT	(20168-1, LN, "Acceleration Time")	(G-C048, SRT, "Direction of Flow") = (R-42047, SRT, "Antegrade Flow")
TV Acc Slope Alias: TV Acc Slope	(20167-3, LN, "Acceleration Slope")	(G-C048, SRT, "Direction of Flow") = (R-42047, SRT, "Antegrade Flow")
TV E Velocity	(18031-5, LN, "Tricuspid Valve E Wave Peak Velocity")	

Alias: TV E Vel		
TV A Velocity Alias: TV A Vel	(18030-7, LN, "Tricuspid Valve A Wave Peak Velocity")	
TV Dec Time Alias: TV Dec Time	(20217-6, LN, "Deceleration Time")	(G-C048, SRT, "Direction of Flow") = (R-42047, SRT, "Antegrade Flow")
TV Dec Slope Alias: TV Dec Slope	(20216-8, LN, "Deceleration Slope")	(G-C048, SRT, "Direction of Flow") = (R-42047, SRT, "Antegrade Flow")
TV PHT Alias: TV PHT	(20280-4, LN, "Pressure Half-Time")	(G-C048, SRT, "Direction of Flow") = (R-42047, SRT, "Antegrade Flow")
TVA Alias: TVA	(G-038E, SRT, "Cardiovascular Orifice Area")	(G-C048, SRT, "Direction of Flow") = (R-42047, SRT, "Antegrade Flow")
TV meanPG Alias: TV meanPG	(20256-4, LN, "Mean Gradient")	(G-C048, SRT, "Direction of Flow") = (R-42047, SRT, "Antegrade Flow")
TV Vmax Alias: TV Vmax	(11726-7, LN, "Peak Velocity")	(G-C048, SRT, "Direction of Flow") = (R-42047, SRT, "Antegrade Flow")
TV Vmax P Alias: TV Vmax	(11726-7, LN, "Peak Velocity")	(G-C048, SRT, "Direction of Flow") = (R-42047, SRT, "Antegrade Flow")
TV Vmean Alias: TV Vmean	(20352-1, LN, "Mean Velocity")	(G-C048, SRT, "Direction of Flow") = (R-42047, SRT, "Antegrade Flow")
TV maxPG Alias: TV maxPG	(20247-3, LN, "Peak Gradient")	(G-C048, SRT, "Direction of Flow") = (R-42047, SRT, "Antegrade Flow")
TV VTI Alias: TV VTI	(20354-7, LN, "Velocity Time Integral")	(G-C048, SRT, "Direction of Flow") = (R-42047, SRT, "Antegrade Flow")
TV Env.Ti	(GEU-106-0088, 99GEMS, "Time duration of the VTI trace")	(G-0373, SRT, «Image Mode») = (R-409E4, SRT, «Doppler Pulsed»)

Alias: TV Env.Ti	on Tricuspid Valve")	(G-C048, SRT, "Direction of Flow") = (R-42047, SRT, "Antegrade Flow")
TV Time To Peak Alias: TV Time to Peak	(GEU-106-0006, 99GEMS, "Time to Peak")	
TVA (VTI) Alias: TVA (VTI)	(G-038E, SRT, "Cardiovascular Orifice Area")	(G-C048, SRT, "Direction of Flow") = (R-42047, SRT, "Antegrade Flow") (G-C036, SRT, "Measurement Method") = (125215, DCM, "Continuity Equation by Velocity Time Integral")
TVA (Vmax) Alias: TVA (Vmax)	(G-038E, SRT, "Cardiovascular Orifice Area")	(G-C048, SRT, "Direction of Flow") = (R-42047, SRT, "Antegrade Flow") (G-C036, SRT, "Measurement Method") = (125214, DCM, "Continuity Equation by Peak Velocity")
TVA (Vmax)P Alias: TVA (Vmax)	(G-038E, SRT, "Cardiovascular Orifice Area")	(G-C048, SRT, "Direction of Flow") = (R-42047, SRT, "Antegrade Flow") (G-C036, SRT, "Measurement Method") = (125214, DCM, "Continuity Equation by Peak Velocity")
TV HR Alias: HR	(8867-4, LN, "Heart rate")	
TV SV Alias: TV SV	(F-32120, SRT, "Stroke Volume")	
TV CO Alias: TV CO	(F32100, SRT, "Cardiac Output")	
TV SI Alias: TV SI	(F-00078, SRT, "Stroke Index")	
TV CI Alias: TV CI	(F-32110, SRT, "Cardiac Index")	

<p>TV Acc Time/TV Dec Time Alias: TV Acc Time/Dec Time</p>	<p>(GEU-106-0074, 99GEMS, "Ratio of Tricuspid Valve acceleration time to deceleration time")</p>	
<p>TV A Dur Alias: TV A Dur</p>	<p>(GEU-106-0075, 99GEMS, "Tricuspid Valve A-Wave duration")</p>	
<p>TV E Prime Lateral Velocity Alias: TV E` Lat Vel</p>	<p>(79924-7, LN, "Tricuspid valve annulus Peak Tissue velocity")</p>	<p>(G-C0E3, SRT, "Finding Site") = (GEU-106-0034, GEU, "Lateral Tricuspid Annulus")</p>
<p>TV E/A Ratio Alias: TV E/A Ratio</p>	<p>(18039-8, LN, "Tricuspid Valve E to A Ratio")</p>	
<p>TV E/A Ratio/Calc Alias: TV E/A Ratio/Calc</p>	<p>(18039-8, LN, "Tricuspid Valve E to A Ratio")</p>	
<p>TV dp/dt Alias: TV dp dt</p>	<p>(59120-6, LN, "Tricuspid Valve antegrade dp/dt [pressure rate] by US")</p>	<p>(G-C048, SRT, "Direction of Flow") = (R-42047, SRT, "Antegrade Flow")</p>
<p>SD/Q-to-TV open Alias: Q-to-TV open</p>	<p>(20296-0, LN, "Time from Q wave to Tricuspid Valve Opens")</p>	<p>(G-0373, SRT, «Image Mode») = (R-409E4, SRT, «Doppler Pulsed») =</p>
<p>TR meanPG Alias: TR meanPG</p>	<p>(20256-4, LN, "Mean Gradient")</p>	<p>(G-C048, SRT, "Direction of Flow") = (R-42E61, SRT, "Regurgitant Flow")</p>
<p>TR Vmax Alias: TR Vmax</p>	<p>(11726-7, LN, "Peak Velocity")</p>	<p>(G-C048, SRT, "Direction of Flow") = (R-42E61, SRT, "Regurgitant Flow")</p>
<p>TR Vmean Alias: TR Vmean</p>	<p>(20352-1, LN, "Mean Velocity")</p>	<p>(G-C048, SRT, "Direction of Flow") = (R-42E61, SRT, "Regurgitant Flow")</p>
<p>TR maxPG Alias: TR maxPG</p>	<p>(20247-3, LN, "Peak Gradient")</p>	<p>(G-C048, SRT, "Direction of Flow") = (R-42E61, SRT, "Regurgitant Flow")</p>
<p>TR VTI</p>	<p>(20354-7, LN, "Velocity Time</p>	<p>(G-C048, SRT, "Direction of Flow") =</p>

Alias: TR VTI	Integral")	(R-42E61, SRT, "Regurgitant Flow")
TR Env.Ti Alias: TR Env.Ti	(GEU-106-0089, 99GEMS, "Time duration of the VTI trace on Tricuspid Regurgitant flow")	(G-0373, SRT, «Image Mode») = (R-409E4, SRT, «Doppler Pulsed») (G-C048, SRT, "Direction of Flow") = (R-42E61, SRT, "Regurgitant Flow")
TR dp/dt Alias: TR dp/dt	(18034-9, LN, "Tricuspid Regurgitation dp/dt derived from Tricuspid Reg Velocity")	
TVET Alias: TVET	(GEU-106-0073, 99GEMS, "Tricuspid Valve Ejection Time")	(G-0373, SRT, «Image Mode») = (R-409E4, SRT, «Doppler Pulsed») = (R-409E3, SRT, "Doppler Continuous Wave")
TCO Alias: TCO	(G-0389, SRT, "Tricuspid Valve Closure to Opening Time")	(G-0373, SRT, "Image Mode") = (R-409E3, SRT, "Doppler Continuous Wave")
PISA/TR/Flow Alias: TR Flow	(34141-2, LN, "Peak Instantaneous Flow Rate")	(G-C048, SRT, "Direction of Flow") = (R-42E61, SRT, "Regurgitant Flow") (G-C036, SRT, "Measurement Method") = (125216, DCM, "Proximal Isovelocity Surface Area")
PISA/TR/Radius Alias: TR Rad	(GEU-106-0004, 99GEMS, "Flow Radius")	(G-C048, SRT, "Direction of Flow") = (R-42E61, SRT, "Regurgitant Flow") (G-C036, SRT, "Measurement Method") = (125216, DCM, "Proximal Isovelocity Surface Area")
PISA/TR/Velocity Alias: TR Als.Vel	(GEU-106-0005, 99GEMS, "Alias Velocity")	(G-C048, SRT, "Direction of Flow") = (R-42E61, SRT, "Regurgitant Flow") (G-C036, SRT, "Measurement Method") = (125216, DCM, "Proximal Isovelocity Surface Area")
PISA/TR/Vmax Alias: TR Vmax	(11726-7, LN, "Peak Velocity")	(G-C048, SRT, "Direction of Flow") = (R-42E61, SRT, "Regurgitant Flow") (G-C036, SRT, "Measurement Method") = (125216, DCM, "Proximal Isovelocity Surface Area")
PISA/TR/VTI Alias: TR VTI	(20354-7, LN, "Velocity Time Integral")	(G-C048, SRT, "Direction of Flow") = (R-42E61, SRT, "Regurgitant Flow") (G-C036, SRT, "Measurement Method") = (125216, DCM, "Proximal Isovelocity Surface Area")

PISA/TR/ERO Alias: TR ERO	(G-038E, SRT, “Cardiovascular Orifice Area”)	(G-C048, SRT, “Direction of Flow”) = (R-42E61, SRT, “Regurgitant Flow”) (G-C036, SRT, “Measurement Method”) = (125216, DCM, “Proximal Isovelocity Surface Area”)
PISA/TR/RV Alias: TR RV	(33878-0, LN, “Volume Flow”)	(G-C048, SRT, “Direction of Flow”) = (R-42E61, SRT, “Regurgitant Flow”) (G-C036, SRT, “Measurement Method”) = (125216, DCM, “Proximal Isovelocity Surface Area”)
TAPSE	(GEU-106-0030, 99GEMS, “Tricuspid Annular Plane Systolic Excursion (TAPSE)”)	
4DAutoRVQ/TAPSE Alias: TAPSE	(GEU-106-0052, 99GEMS, “TAPSE from 4D image”)	(G-0373, SRT, “Image Mode”) = (125231, DCM, “3D mode”) (G-C036, SRT, “Measurement Method”) = (GEU-106-0048, 99GEMS, “4D auto RV quantification tool”)

Section Aorta

GEU Parameter ID (and corresponding alias)	Base Measurement Concept Name	Concept or Acquisition Context Modifier
MM/LAAo/Ao Root Diam Alias: Ao Diam	(18015-8, LN, “Aortic Root Diameter”)	(G-0373, SRT, «Image Mode») = (G-0394, SRT, «M mode»)
2D/Ao Root Diam Alias: Ao Diam	(18015-8, LN, “Aortic Root Diameter”)	(G-0373, SRT, “Image Mode”) = (G-03A2, SRT, “2D mode”) or (R-409E2, SRT, “Doppler Color Flow”) depending on scan mode
2D/Ao Asc Diam Alias: Ao asc	(18012-5, LN, “Ascending Aortic Diameter”)	(G-0373, SRT, “Image Mode”) = (G-03A2, SRT, “2D mode”) or (R-409E2, SRT, “Doppler Color Flow”) depending on scan mode
2D/Ao Arch Diam Alias: Ao Arch Diam	(18011-7, LN, “Aortic Arch Diameter”)	(G-0373, SRT, “Image Mode”) = (G-03A2, SRT, “2D mode”) or (R-409E2, SRT, “Doppler Color Flow”) depending on scan mode
2D/Ao Desc Diam	(18013-3, LN, “Descending	(G-0373, SRT, “Image Mode”) = (G-03A2,

Alias: Ao Desc Diam	Aortic Diameter”)	SRT, “2D mode”) or (R-409E2, SRT, “Doppler Color Flow”) depending on scan mode
2D/Ao Isthmus Alias: Ao Isthmus	(18014-1, LN, “Aortic Isthmus Diameter”)	(G-0373, SRT, “Image Mode”) = (G-03A2, SRT, “2D mode”) or (R-409E2, SRT, “Doppler Color Flow”) depending on scan mode
MM/Ao Root Diam Alias: Ao Diam	(18015-8, LN, “Aortic Root Diameter”)	(G-0373, SRT, «Image Mode») = (G-0394, SRT, «M mode»)
Asc Ao Vmax Alias: Aao Vmax	(11726-7, LN, “Peak Velocity”)	(G-C0E3, SRT, “Finding Site”) = (T-42100, SRT, “Ascending Aorta”)
Asc Ao maxPG Alias: Aao maxPG	(20247-3, LN, “Peak Gradient”)	(G-C0E3, SRT, “Finding Site”) = (T-42100, SRT, “Ascending Aorta”)
Asc Ao Vmean Alias: Ao Vmean	(20352-1, LN, “Mean Velocity”)	(G-C0E3, SRT, “Finding Site”) = (T-42100, SRT, “Ascending Aorta”)
Asc Ao meanPG Alias Ao meanPG	(20256-4, LN, “Mean Gradient”)	(G-C0E3, SRT, “Finding Site”) = (T-42100, SRT, “Ascending Aorta”)
Asc Ao Env. Ti Alias: Ao Env. Ti	(GEU-106-0132, 99GEMS, “Time duration of the VTI trace”)	(G-C0E3, SRT, “Finding Site”) = (T-42100, SRT, “Ascending Aorta”)
Asc Ao VTI Alias: Ao VTI	(20354-7, LN, “Velocity Time Integral”)	(G-C0E3, SRT, “Finding Site”) = (T-42100, SRT, “Ascending Aorta”)
Dsc Ao Vmax Alias: Dao Vmax	(11726-7, LN, “Peak Velocity”)	(G-C0E3, SRT, “Finding Site”) = (T-D0765, SRT, “Descending Aorta”)
Dsc Ao maxPG Alias: Dao maxPG	(20247-3, LN, “Peak Gradient”)	(G-C0E3, SRT, “Finding Site”) = (T-D0765, SRT, “Descending Aorta”)
Dsc Ao Vmean Alias: Dao Vmean	(20352-1, LN, “Mean Velocity”)	(G-C0E3, SRT, “Finding Site”) = (T-D0765, SRT, “Descending Aorta”)
Dsc Ao meanPG	(20256-4, LN, “Mean	(G-C0E3, SRT, “Finding Site”) = (T-D0765,

Alias Dao meanPG	Gradient")	SRT, "Descending Aorta")
Dsc Ao Env. Ti Alias: Dao Env. Ti	(GEU-106-0132, 99GEMS, "Time duration of the VTI trace")	(G-C0E3, SRT, "Finding Site") = (T-D0765, SRT, "Descending Aorta")
Dsc Ao VTI Alias: Dao VTI	(20354-7, LN, "Velocity Time Integral")	(G-C0E3, SRT, "Finding Site") = (T-D0765, SRT, "Descending Aorta")

Section Pulmonary Artery

GEU Parameter ID (and corresponding alias)	Base Measurement Concept Name	Concept or Acquisition Context Modifier
2D/MPA Alias: MPA	(18020-8, LN, "Main Pulmonary Artery Diameter")	(G-0373, SRT, "Image Mode") = (G-03A2, SRT, "2D mode") or (R-409E2, SRT, "Doppler Color Flow") depending on scan mode
2D/RPA Alias: RPA	(18021-6, LN, "Right Pulmonary Artery Diameter")	(G-0373, SRT, "Image Mode") = (G-03A2, SRT, "2D mode") or (R-409E2, SRT, "Doppler Color Flow") depending on scan mode
2D/LPA Alias: LPA	(18019-0, LN, "Left Pulmonary Artery Diameter")	(G-0373, SRT, "Image Mode") = (G-03A2, SRT, "2D mode") or (R-409E2, SRT, "Doppler Color Flow") depending on scan mode
2D/LAX/RPA area Alias: LAX RPA area	(G-A166, SRT, "Area")	(G-0373, SRT, "Image Mode") = (G-03A2, SRT, "2D mode") (G-C0E3, SRT, "Finding Site") = (T-44200, SRT, "Right Pulmonary Artery") (111031, DCM, "Image View") = (G-0396, SRT, "Parasternal long axis")
2D/LAX/LPA area Alias: LAX LPA area	(G-A166, SRT, "Area")	(G-0373, SRT, "Image Mode") = (G-03A2, SRT, "2D mode") (G-C0E3, SRT, "Finding Site") = (T-44400, SRT, "Left Pulmonary Artery") (111031, DCM, "Image View") = (G-0396,

		SRT, "Parasternal long axis")
2D/SAX/RPA area Alias: SAX RPA area	(G-A166, SRT, "Area")	(G-0373, SRT, "Image Mode") = (G-03A2, SRT, "2D mode") (G-C0E3, SRT, "Finding Site") = (T-44200, SRT, "Right Pulmonary Artery") (111031, DCM, "Image View") = (G-0398, SRT, "Parasternal short axis at the aortic valve level")
2D/SAX/LPA area Alias: SAX LPA area	(G-A166, SRT, "Area")	(G-0373, SRT, "Image Mode") = (G-03A2, SRT, "2D mode") (G-C0E3, SRT, "Finding Site") = (T-44400, SRT, "Left Pulmonary Artery") (111031, DCM, "Image View") = (G-0398, SRT, "Parasternal short axis at the aortic valve level")
2D/LAX/Trans AoD diastole Alias: LAX Trans AoD diastole		(R-4089A, SRT, "Cardiac Cycle Point") = (F-32011, SRT, "End Diastole") (111031, DCM, "Image View") = (G-0395, SRT, "Apical long axis")
2D/LAX/Trans AoD systole Alias: LAX Trans AoD systole		(R-4089A, SRT, "Cardiac Cycle Point") = (109070, DCM, "End Systole") (111031, DCM, "Image View") = (G-0395, SRT, "Apical long axis")
2D/SAX/Trans AoD diastole Alias: SAX Trans AoD diastole		(R-4089A, SRT, "Cardiac Cycle Point") = (F-32011, SRT, "End Diastole") (111031, DCM, "Image View") = (G-0398, SRT, "Parasternal short axis at the aortic valve level")
2D/SAX/Trans AoD systole Alias: SAX Trans AoD systole		(R-4089A, SRT, "Cardiac Cycle Point") = (109070, DCM, "End Systole") (111031, DCM, "Image View") = (G-0398, SRT, "Parasternal short axis at the aortic valve level")
RPA Vmax	(11726-7, LN, "Peak Velocity")	(G-C0E3, SRT, "Finding Site") = (T-44200, SRT, "Right Pulmonary Artery")

Alias: RPA Vmax		
RPA maxPG Alias: RPA maxPG	(20247-3, LN, "Peak Gradient")	(G-C0E3, SRT, "Finding Site") = (T-44200, SRT, "Right Pulmonary Artery")
LPA Vmax Alias: LPA Vmax	(GEU-106-0014, 99GEMS, "Left Pulmonary Artery Peak Velocity")	
LPA maxPG Alias: LPA maxPG	(GEU-106-0015, 99GEMS, "Left Pulmonary Artery Peak Gradient")	
MPA Vmax Alias: MPA Vmax	(G-038A, SRT, "Main Pulmonary Artery Peak Velocity")	

Section Pulmonary Venous Structure

GEU Parameter ID (and corresponding alias)	Base Measurement Concept Name	Concept or Acquisition Context Modifier
P_Vein S Alias: P Vein S	(29450-4, LN, "Pulmonary Vein Systolic Peak Velocity")	
P_Vein D Alias: P Vein D	(29451-2, LN, "Pulmonary Vein Diastolic Peak Velocity")	
P_Vein A Alias: P Vein A	(29453-8, LN, "Pulmonary Vein Atrial Contraction Reversal Peak Velocity")	
P_Vein A Dur Alias: P Vein A Dur	(G-038B, SRT, "Pulmonary Vein A-Wave Duration")	
P_Vein S/D Ratio Alias: P Vein S/D Ratio	(29452-0, LN, "Pulmonary Vein Systolic to Diastolic Ratio")	
P_Vein S VTI Alias: P Vein S VTI	(G-038C, SRT, "Pulmonary Vein S-Wave Velocity Time Integral")	

P_Vein D VTI Alias: P Vein D VTI	(G-038D, SRT, “Pulmonary Vein D-Wave Velocity Time Integral”)	
P_Vein S Env.Ti Alias: P Vein S Env.Ti	(GEU-106-0083, 99GEMS, “Time duration of the VTI trace on Pulmonary Vein S-Wave”)	(G-0373, SRT, «Image Mode») = (R-409E4, SRT, «Doppler Pulsed»)
P_Vein D Env.Ti Alias: P Vein D Env.Ti	(GEU-106-0084, 99GEMS, “Time duration of the VTI trace on Pulmonary Vein D-Wave”)	(G-0373, SRT, «Image Mode») = (R-409E4, SRT, «Doppler Pulsed»)
PA Vmax Alias: PA Vmax	(11726-7, LN, “Peak Velocity”)	
PA max PG Alias: PA max PG	(20247-3, LN, “Peak Gradient”)	

Section Vena Cava

GEU Parameter ID (and corresponding alias)	Base Measurement Concept Name	Concept or Acquisition Context Modifier
2D/IVC Diam Ins Alias: IVC Diam Ins	(18006-7, LN, “Inferior Vena Cava Diameter”)	(R-40899, SRT, “Respiratory Cycle Point”) = (F-20010, SRT, “During Inspiration”)
2D/IVC Diam Exp Alias: IVC Diam Exp	(18006-7, LN, “Inferior Vena Cava Diameter”)	(R-40899, SRT, “Respiratory Cycle Point”) = (F-20020, SRT, “During Expiration”)
2D/IVC Alias: IVC	(18006-7, LN, “Inferior Vena Cava Diameter”)	(G-0373, SRT, “Image Mode”) = (G-03A2, SRT, “2D mode”) or (R-409E2, SRT, “Doppler Color Flow”) depending on scan mode
2D/SVC Diam Ins Alias: SVC Diam Ins	(18007-5, LN, “Superior Vena Cava Diameter”)	(G-0373, SRT, “Image Mode”) = (G-03A2, SRT, “2D mode”) = (R-40899, SRT, “Respiratory Cycle Point”) = (F-20010, SRT, “During Inspiration”)
2D/SVC DIAM Exp Alias: AVC Diam Exp	(18007-5, LN, “Superior Vena Cava Diameter”)	(G-0373, SRT, “Image Mode”) = (G-03A2, SRT, “2D mode”) = (R-40899, SRT, “Respiratory Cycle Point”) = (F-20020, SRT, “During Expiration”)

2D/IVC Collapse Index Alias: IVC Collapse Index	(18050-5, LN, "Inferior Vena Cava % Collapse")	
2D/SVC Collapse Index Alias: SVC Collapse Index	(GEU-106-0133, 99GEMS, "Superior Vena Cava % Collapse")	

Section Cardiac Shunt Study

GEU Parameter ID (and corresponding alias)	Base Measurement Concept Name	Concept or Acquisition Context Modifier
Qp/Qs Alias: Qp/Qs	(29462-9, LN, "Pulmonary-to-Systemic Shunt Flow Ratio")	
Systemic VTI Alias: Systemic VTI	(20354-7, LN, "Velocity Time Integral")	(G-C048, SRT, "Direction of Flow") = (F-32330, SRT, "Left to right cardiovascular shunt")
Pulmonic VTI Alias: Pulmonic VTI	(20354-7, LN, "Velocity Time Integral")	(G-C048, SRT, "Direction of Flow") = (F-32340, SRT, "Right to left cardiovascular shunt")

Section Congenital Anomaly of Cardiovascular System

GEU Parameter ID (and corresponding alias)	Base Measurement Concept Name	Concept or Acquisition Context Modifier
2D/ASD Diam Alias: ASD Diam	(G-038F, SRT, "Cardiovascular Orifice Diameter")	(G-C0E3, SRT, "Finding Site") = (D4-31220, SRT, "Atrial Septal Defect") (G-0373, SRT, "Image Mode") = (G-03A2, SRT, "2D mode") or (R-409E2, SRT, "Doppler Color Flow") depending on scan mode
2D/VSD Diam Alias: VSD Diam	(G-038F, SRT, "Cardiovascular Orifice Diameter")	(G-C0E3, SRT, "Finding Site") = (D4-31150, SRT, "Ventricular Septal Defect") (G-0373, SRT, "Image Mode") = (G-03A2, SRT, "2D mode") or (R-409E2, SRT, "Doppler Color Flow") depending on scan mode

<p>2D/Pre Ductal</p> <p>Alias: Pre Ductal</p>	<p>(M-02550, SRT, "Diameter")</p>	<p>(G-0373, SRT, "Image Mode") = (G-03A2, SRT, "2D mode")</p> <p>(G-C0E3, SRT, "Finding Site") = (T-42340, SRT, "Preductal region of aortic arch")</p>
<p>2D/Post Ductal</p> <p>Alias: Post Ductal</p>	<p>(M-02550, SRT, "Diameter")</p>	<p>(G-0373, SRT, "Image Mode") = (G-03A2, SRT, "2D mode")</p> <p>(G-C0E3, SRT, "Finding Site") = (T-42350, SRT, "Postductal region of aortic arch")</p>
<p>2D/Systemic Diam</p> <p>Alias: Systemic Diam</p>	<p>(M-02550, SRT, "Diameter")</p>	<p>(G-0373, SRT, "Image Mode") = (G-03A2, SRT, "2D mode")</p> <p>(G-C0E3, SRT, "Finding Site") = (T-32550, SRT, "Right Ventricle Outflow Tract")</p>
<p>2D/Pulmonic Diam</p> <p>Alias: Pulmonic Diam</p>	<p>(M-02550, SRT, "Diameter")</p>	<p>(G-0373, SRT, "Image Mode") = (G-03A2, SRT, "2D mode")</p> <p>(G-C0E3, SRT, "Finding Site") = (T-32650, SRT, "Left Ventricle Outflow Tract")</p>
<p>VSD Vmax</p> <p>Alias: VSD Vmax</p>	<p>(11726-7, LN, "Peak Velocity")</p>	<p>(G-C0E3, SRT, "Finding Site") = (D4-31150, SRT, "Ventricular Septal Defect")</p>
<p>VSD maxPG</p> <p>Alias: VSD maxPG</p>	<p>(20247-3, LN, "Peak Gradient")</p>	<p>(G-C0E3, SRT, "Finding Site") = (D4-31150, SRT, "Ventricular Septal Defect")</p>
<p>ASD Vmax</p> <p>Alias: ASD Vmax</p>	<p>(11726-7, LN, "Peak Velocity")</p>	<p>(G-C0E3, SRT, "Finding Site") = (D4-31220, SRT, "Atrial Septal Defect")</p>
<p>ASD maxPG</p> <p>Alias: ASD maxPG</p>	<p>(20247-3, LN, "Peak Gradient")</p>	<p>(G-C0E3, SRT, "Finding Site") = (D4-31220, SRT, "Atrial Septal Defect")</p>
<p>Systemic HR</p> <p>Alias: Systemic HR</p>	<p>(8867-4, LN, "Heart rate")</p>	<p>(G-0373, SRT, «Image Mode») = (R-409E4, SRT, «Doppler Pulsed»)</p> <p>(G-C0E3, SRT, "Finding Site") = (T-32550, SRT, "Right Ventricle Outflow")</p>

		Tract")
<p>Systemic Vmax Alias: Systemic Vmax</p>	<p>(11726-7, LN, "Peak Velocity on systemic side")</p>	<p>(G-0373, SRT, «Image Mode») = (R-409E4, SRT, «Doppler Pulsed») (G-C0E3, SRT, "Finding Site") = (T-32550, SRT, "Right Ventricle Outflow Tract")</p>
<p>Systemic Vmean Alias: Systemic Vmean</p>	<p>(20352-1, LN, "Mean Velocity on systemic side")</p>	<p>(G-0373, SRT, «Image Mode») = (R-409E4, SRT, «Doppler Pulsed») (G-C0E3, SRT, "Finding Site") = (T-32550, SRT, "Right Ventricle Outflow Tract")</p>
<p>Systemic maxPG Alias: Systemic maxPG</p>	<p>(20247-3, LN, "MPeak Gradient on systemic side")</p>	<p>(G-0373, SRT, «Image Mode») = (R-409E4, SRT, «Doppler Pulsed») (G-C0E3, SRT, "Finding Site") = (T-32550, SRT, "Right Ventricle Outflow Tract")</p>
<p>Systemic meanPG Alias: Systemic meanPG</p>	<p>(20256-4, LN, "Mean Gradient on systemic side")</p>	<p>(G-0373, SRT, «Image Mode») = (R-409E4, SRT, «Doppler Pulsed») (G-C0E3, SRT, "Finding Site") = (T-32550, SRT, "Right Ventricle Outflow Tract")</p>
<p>Systemic SV Alias: Systemic SV</p>	<p>(F-32120, SRT, "Stroke Volume on systemic side")</p>	<p>(G-0373, SRT, «Image Mode») = (R-409E4, SRT, «Doppler Pulsed») (G-C0E3, SRT, "Finding Site") = (T-32550, SRT, "Right Ventricle Outflow Tract")</p>
<p>Systemic CO Alias: Systemic CO</p>	<p>(F-32100, SRT, "Cardiac Output on systemic side")</p>	<p>(G-0373, SRT, «Image Mode») = (R-409E4, SRT, «Doppler Pulsed») (G-C0E3, SRT, "Finding Site") = (T-32550, SRT, "Right Ventricle Outflow Tract")</p>
<p>Systemic Env.Ti Alias: Systemic Env.Ti</p>	<p>(GEU-106-0090, 99GEMS, "Time duration of the VTI trace on Systemic side flow")</p>	<p>(G-0373, SRT, «Image Mode») = (R-409E4, SRT, «Doppler Pulsed») (G-C0E3, SRT, "Finding Site") = (T-32550, SRT, "Right Ventricle Outflow Tract")</p>

<p>Pulmonic HR</p> <p>Alias: Pulmonic HR</p>	<p>(8867-4, LN, "Heart rate")</p>	<p>(G-0373, SRT, «Image Mode») = (R-409E4, SRT, «Doppler Pulsed»)</p> <p>(G-C0E3, SRT, "Finding Site") = (T-32650, SRT, "Left Ventricle Outflow Tract")</p>
<p>Pulmonic Vmax</p> <p>Alias: Pulmonic Vmax</p>	<p>(11726-7, LN, "Peak Velocity on pulmonic side")</p>	<p>(G-0373, SRT, «Image Mode») = (R-409E4, SRT, «Doppler Pulsed»)</p> <p>(G-C0E3, SRT, "Finding Site") = (T-32650, SRT, "Left Ventricle Outflow Tract")</p>
<p>Pulmonic Vmean</p> <p>Alias: Pulmonic Vmean</p>	<p>(20352-1, LN, "Mean Velocity on pulmonic side")</p>	<p>(G-0373, SRT, «Image Mode») = (R-409E4, SRT, «Doppler Pulsed»)</p> <p>(G-C0E3, SRT, "Finding Site") = (T-32650, SRT, "Left Ventricle Outflow Tract")</p>
<p>Pulmonic maxPG</p> <p>Alias: Pulmonic maxPG</p>	<p>(20247-3, LN, "Peak Gradient on pulmonic side")</p>	<p>(G-0373, SRT, «Image Mode») = (R-409E4, SRT, «Doppler Pulsed»)</p> <p>(G-C0E3, SRT, "Finding Site") = (T-32650, SRT, "Left Ventricle Outflow Tract")</p>
<p>Pulmonic meanPG</p> <p>Alias: Pulmonic meanPG</p>	<p>(20256-4, LN, "Mean Gradient on pulmonic side")</p>	<p>(G-0373, SRT, «Image Mode») = (R-409E4, SRT, «Doppler Pulsed»)</p> <p>(G-C0E3, SRT, "Finding Site") = (T-32650, SRT, "Left Ventricle Outflow Tract")</p>
<p>Pulmonic SV</p> <p>Alias: Pulmonic SV</p>	<p>(F-32120, SRT, "Stroke Volume on pulmonic side")</p>	<p>(G-0373, SRT, «Image Mode») = (R-409E4, SRT, «Doppler Pulsed»)</p> <p>(G-C0E3, SRT, "Finding Site") = (T-32650, SRT, "Left Ventricle Outflow Tract")</p>
<p>Pulmonic CO</p> <p>Alias: Pulmonic CO</p>	<p>(F32100, SRT, "Cardiac Output on pulmonic side")</p>	<p>(G-0373, SRT, «Image Mode») = (R-409E4, SRT, «Doppler Pulsed»)</p> <p>(G-C0E3, SRT, "Finding Site") = (T-32650, SRT, "Left Ventricle Outflow Tract")</p>

<p>Pulmonic Env.Ti Alias: Pulmonic Env.Ti</p>	<p>(GEU-106-0091, 99GEMS, “Time duration of the VTI trace on Pulmonic side flow”)</p>	<p>(G-0373, SRT, «Image Mode») = (R-409E4, SRT, «Doppler Pulsed») (G-C0E3, SRT, “Finding Site”) = (T-32650, SRT, “Left Ventricle Outflow Tract”)</p>
<p>Coarctation/Post-Ductal Alias: Coarctation Post Ductal</p>	<p>(17995-2, LN, “Thoracic Aorta Coarctation Systolic Peak Instantaneous Gradient”)</p>	
<p>Coarctation/Post-Ductal PG Alias: Coarctation Post Ductal PG</p>	<p>(20256-4, LN, “Mean Gradient”)</p>	<p>(G-C0E3, SRT, “Finding Site”) = (D4-32030, SRT, “Thoracic Aortic Coarctation”)</p>
<p>Coarctation/Pre-Ductal Alias: Pre-Ductal</p>	<p>(GEU-106-0107, 99GEMS, “Peak Velocity in the Pre-Ductal area of the Aortic Coarctation”)</p>	<p>(G-C0E3, SRT, “Finding Site”) = (D4-32030, SRT, “Thoracic Aortic Coarctation”)</p>
<p>Coarctation/Pre-Ductal PG Alias: Pre-Ductal PG</p>	<p>(GEU-106-0108, 99GEMS, “Maximum Pressure Gradient in the Pre-Ductal area of the Aortic Coarctation”)</p>	<p>(G-C0E3, SRT, “Finding Site”) = (D4-32030, SRT, “Thoracic Aortic Coarctation”)</p>
<p>ASD Vmean Alias: ASD Vmean</p>	<p>(20352-1, LN, “Mean Velocity”)</p>	<p>(G-C0E3, SRT, “Finding Site”) = (D4-31220, SRT, “Atrial Septal Defect”)</p>
<p>ASD meanPG Alias: ASD meanPG</p>	<p>(20256-4, LN, “Mean Gradient”)</p>	<p>(G-C0E3, SRT, “Finding Site”) = (D4-31220, SRT, “Atrial Septal Defect”)</p>
<p>ASD Env. Ti Alias: ASD Env. Ti</p>	<p>(GEU-106-0132, 99GEMS, “Time duration of the VTI trace”)</p>	<p>(G-C0E3, SRT, “Finding Site”) = (D4-31220, SRT, “Atrial Septal Defect”)</p>
<p>ASD VTI Alias: ASD VTI</p>	<p>(20354-7, LN, “Velocity Time Integral”)</p>	<p>(G-C0E3, SRT, “Finding Site”) = (D4-31220, SRT, “Atrial Septal Defect”)</p>
<p>VSD Vmean Alias: VSD Vmean</p>	<p>(20352-1, LN, “Mean Velocity”)</p>	<p>(G-C0E3, SRT, “Finding Site”) = (D4-31150, SRT, “Ventricular Septal Defect”)</p>

VSD meanPG Alias: VSD meanPG	(20256-4, LN, "Mean Gradient")	(G-C0E3, SRT, "Finding Site") = (D4-31150, SRT, "Ventricular Septal Defect")
VSD Env. Ti Alias: VSD Env. Ti	(GEU-106-0132, 99GEMS, "Time duration of the VTI trace")	(G-C0E3, SRT, "Finding Site") = (D4-31150, SRT, "Ventricular Septal Defect")
VSD VTI Alias: VSD VTI	(20354-7, LN, "Velocity Time Integral")	(G-C0E3, SRT, "Finding Site") = (D4-31150, SRT, "Ventricular Septal Defect")

Section Pericardial cavity

GEU Parameter ID (and corresponding alias)	Base Measurement Concept Name	Concept or Acquisition Context Modifier
2D/Pes Alias: Pes	(121206, DCM, "Distance")	(G-C0E3, SRT, "Finding Site") = (D3-90008, SRT, "Pericardial effusion") (G-0373, SRT, "Image Mode") = (G-03A2, SRT, "2D mode") or (R-409E2, SRT, "Doppler Color Flow") depending on scan mode (R-4089A, SRT, "Cardiac Cycle Point") = (F-32020, SRT, "Systole")
2D/Ped Alias: Ped	(121206, DCM, "Distance")	(G-C0E3, SRT, "Finding Site") = (D3-90008, SRT, "Pericardial effusion") (G-0373, SRT, "Image Mode") = (G-03A2, SRT, "2D mode") or (R-409E2, SRT, "Doppler Color Flow") depending on scan mode (R-4089A, SRT, "Cardiac Cycle Point") = (F-32010, SRT, "Diastole")
MM/Ped Alias: Ped	(121206, DCM, "Distance")	(G-C0E3, SRT, "Finding Site") = (D3-90008, SRT, "Pericardial effusion") (G-0373, SRT, "Image Mode") = (G-0394, SRT, "M mode") (R-4089A, SRT, "Cardiac Cycle Point") = (F-32010, SRT, "Diastole")

Section Aortic Sinotubular Junction

GEU Parameter ID (and corresponding alias)	Base Measurement Concept Name	Concept or Acquisition Context Modifier
--	-------------------------------	---

2D/Ao st junct Alias: Ao st junct	(M-02550, SRT, "Diameter")	(G-0373, SRT, "Image Mode") = (G-03A2, SRT, "2D mode")
2D/Ao st junct/Ao Alias: Ao st junct/Ao	(59116-4, LN, "Aortic sinotubular junction diameter/Aortic root diameter by US")	(G-0373, SRT, "Image Mode") = (G-03A2, SRT, "2D mode")
2D/Ao Diam Stub Alias: Ao Diam Stub	(GEU-106-0068, 99GEMS, "Aortic diameter at sinotubular transition")	(G-0373, SRT, "Image Mode") = (G-03A2, SRT, "2D mode")

Section Sinus Valsalva

GEU Parameter ID (and corresponding alias)	Base Measurement Concept Name	Concept or Acquisition Context Modifier
2D/Ao Diam Svls Alias: Ao Diam Svls	(M-02550, SRT, "Diameter")	(G-0373, SRT, "Image Mode") = (G-03A2, SRT, "2D mode")
2D/SinusesOfValsalva Alias: Sinuses of Val	(M-02550, SRT, "Diameter")	

Section Patent Ductus Arteriosus

GEU Parameter ID (and corresponding alias)	Base Measurement Concept Name	Concept or Acquisition Context Modifier
2D/PDA Diam Alias: PDA Diam	(M-02550, SRT, "Diameter")	(G-0373, SRT, "Image Mode") = (G-03A2, SRT, "2D mode")
PDA Systolic Alias: PDA Systolic	(11726-7, LN, "Peak Velocity")	(G-0373, SRT, «Image Mode») = (R-409E4, SRT, «Doppler Pulsed») = (R-4089A, SRT, "Cardiac Cycle Point") = (F-32020, SRT, "Systole")
PDA Systolic PG	(20247-3, LN, "Peak Gradient")	(G-0373, SRT, «Image Mode») = (R-

Alias: PDA Systolic PG		409E4, SRT, «Doppler Pulsed») (R-4089A, SRT, "Cardiac Cycle Point") = (F-32020, SRT, "Systole")
PDA Systolic Vmean Alias: PDA Systolic Vmean	(20352-1, LN, "Mean Velocity")	(R-4089A, SRT, "Cardiac Cycle Point") = (F-32020, SRT, "Systole")
PDA Systolic meanPG Alias: PDA Systolic meanPG	(20256-4, LN, "Mean Gradient")	(R-4089A, SRT, "Cardiac Cycle Point") = (F-32020, SRT, "Systole")
PDA Systolic Env. Ti Alias: PDA Systolic Env. Ti	(GEU-106-0132, 99GEMS, "Time duration of the VTI trace")	(R-4089A, SRT, "Cardiac Cycle Point") = (F-32020, SRT, "Systole")
PDA Systolic VTI Alias: PDA Systolic VTI	(20354-7, LN, "Velocity Time Integral")	(R-4089A, SRT, "Cardiac Cycle Point") = (F-32020, SRT, "Systole")
PDA Diastolic Alias: PDA Diastolic	(11726-7, LN, "Peak Velocity")	(G-0373, SRT, «Image Mode») = (R-409E4, SRT, «Doppler Pulsed») (R-4089A, SRT, "Cardiac Cycle Point") = (F-32010, SRT, "Diastole")
Alias: PDA Diastolic PG	(20247-3, LN, "Peak Gradient")	(G-0373, SRT, «Image Mode») = (R-409E4, SRT, «Doppler Pulsed») (R-4089A, SRT, "Cardiac Cycle Point") = (F-32010, SRT, "Diastole")
PDA Diastolic Vmean Alias: PDA Diastolic Vmean	(20352-1, LN, "Mean Velocity")	(R-4089A, SRT, "Cardiac Cycle Point") = (F-32010, SRT, "Diastole")
PDA Diastolic meanPG Alias: PDA Diastolic meanPG	(20256-4, LN, "Mean Gradient")	(R-4089A, SRT, "Cardiac Cycle Point") = (F-32010, SRT, "Diastole")
PDA Diastolic Env. Ti Alias: PDA Diastolic Env.	(GEU-106-0132, 99GEMS, "Time duration of the VTI trace")	(R-4089A, SRT, "Cardiac Cycle Point") = (F-32010, SRT, "Diastole")

Ti		
PDA Diastolic VTI Alias: PDA Diastolic VTI	(20354-7, LN, "Velocity Time Integral")	(R-4089A, SRT, "Cardiac Cycle Point") = (F-32010, SRT, "Diastole")

Section Patent Foramen Ovale

GEU Parameter ID (and corresponding alias)	Base Measurement Concept Name	Concept or Acquisition Context Modifier
2D/PEs Alias: PEs	(M-02550, SRT, "Diameter")	(G-0373, SRT, "Image Mode") = (G-03A2, SRT, "2D mode")

Section Coronary Artery

GEU Parameter ID (and corresponding alias)	Base Measurement Concept Name	Concept or Acquisition Context Modifier
2D/LCA Alias: LCA	(M-02550, SRT, "Diameter")	(G-0373, SRT, "Image Mode") = (G-03A2, SRT, "2D mode") (G-C0E3, SRT, "Finding Site") = (T-43107, SRT, "Left Main Coronary Artery")
2D/RCA Alias: RCA	(M-02550, SRT, "Diameter")	(G-C0E3, SRT, "Finding Site") = (T-43203, SRT, "Right Coronary Artery")
2D/LCX Alias: LCX	(M-02550, SRT, "Diameter")	(G-C0E3, SRT, "Finding Site") = (T-43120, SRT, "Circumflex Coronary Artery")

Section Mitral Valve (prosthetics)

GEU Parameter ID (and corresponding alias)	Base Measurement Concept Name	Concept or Acquisition Context Modifier
MP VTI	(20354-7, LN, "Velocity Time	(G-C048, SRT, "Direction of Flow") =

Alias: MP VTI	Integral")	(R-42047, SRT, "Antegrade Flow")
MP Area Alias: MP Area	(G-038E, SRT, "Cardiovascular Orifice Area")	(125215, DCM, "Continuity Equation by Velocity Time Integral")

Section Aortic Valve (prosthetics)

GEU Parameter ID (and corresponding alias)	Base Measurement Concept Name	Concept or Acquisition Context Modifier
AP VTI Alias: AP VTI	(20354-7, LN, "Velocity Time Integral")	(G-C048, SRT, "Direction of Flow") = (R-42047, SRT, "Antegrade Flow")
AP Area Alias: AP Area	(G-038E, SRT, "Cardiovascular Orifice Area")	(125215, DCM, "Continuity Equation by Velocity Time Integral")

15. VASCULAR ULTRASOUND PROCEDURE REPORT

This section describes the contents of the Vascular Ultrasound Procedure Report (TID 5100) SR.

Note: If “Use older SR version” is enabled (see 2.6, 3.6 and 7) the corresponding section present in the DICOM Conformance Statement of the selected version should be used.

15.1 USAGE AND EXTENSION OF TID 5100 VASCULAR ULTRASOUND REPORT

	NL	Relation with Parent	Value Type	Concept Name	VM	Req Type	Condition	Value Set Constraint
1			CONTAINER	EV (125100, DCM, “Vascular Ultrasound Procedure Report”)	1	M		
	>	HAS OBS CONTEXT	INCLUDE	DTID (1001) Observation Context	1	M		
	>	CONTAINS	INCLUDE	DTID (5101) Vascular Patient Characteristics	1	U		
	>	CONTAINS	INCLUDE	DTID (5102) Vascular Procedure Summary Section	1	U		
	>	CONTAINS	INCLUDE	DTID (5103) Vascular Ultrasound Section	1-n	U		

15.2 TID 5101 VASCULAR PATIENT CHARACTERISTICS

	NL	Relation with Parent	Value Type	Concept Name	VM	Req Type	Condition	Value Set Constraint
1			CONTAINER	EV (121118, DCM, “Patient Characteristics”)	1	M		
	>	CONTAINS	NUM	EV (121033, DCM, “Subject Age”)	1	U		Units = DCID (7456) Units of Measure for Age
	>	CONTAINS	CODE	EV (121032, DCM, “Subject Sex”)	1	U		DCID (7455) Sex
	>	CONTAINS	NUM	EV (8867-4, LN, “Heart Rate”)	1	U		

	>	CONTAINS	NUM	EV (F-008EC, SRT, "Systolic Blood Pressure")	1	U		
	>	CONTAINS	NUM	EV (F-008ED, SRT, "Diastolic Blood Pressure")	1	U		

15.3 TID 5102 VASCULAR PROCEDURE SUMMARY SECTION

	NL	Relation with Parent	Value Type	Concept Name	VM	Req Type	Condition	Value Set Constraint
1			CONTAINER	DT (121111, DCM, "Summary")	1	M		
	>	CONTAINS	TEXT	EV (121106, DCM, "Comment")	1	M		

15.4 TID 5103 VASCULAR ULTRASOUND SECTION (EXTENDED)

	NL	Relation with Parent	Value Type	Concept Name	VM	Req Type	Condition	Value Set Constraint
			CONTAINER	DT (121070, DCM, "Findings")	1	M		
	>	HAS CONCEPT MOD	CODE	EV (G-C0E3, SRT, "Finding Site")	1	M		See 15.6. GEU Applications and Extensions - \$SectionScope
	>	HAS CONCEPT MOD	CODE	EV (G-C171, SRT, "Laterality")	1	U		See 15.9 GE Ultrasound Sidedness and Vessel Location
	>	HAS CONCEPT MOD	CODE	EV (G-0373, SRT, "Image Mode")	1	M		See 15.8 GE Ultrasound modes.
	>	CONTAINS	INCLUDE	DTID (5104) Vascular Measurement Group	1-n	M		See 15.5 TID 5104 Vascular Ultrasound Measurement Group
	>	CONTAINS	INCLUDE	DTID (300) Measurement	1-n	U		\$Measurement = \$AnatomyRatio

* This template is extended with the Image Mode row.

15.5 TID 5104 VASCULAR ULTRASOUND MEASUREMENT GROUP

	NL	Relation with Parent	Value Type	Concept Name	VM	Req Type	Condition	Value Set Constraint
1			CONTAINER	\$Anatomy GEU Parameters	1	M		See 15.6 GEU Applications and Extensions – Anatomy GEU Parameter
	>	HAS CONCEPT MOD	CODE	EV (G-A1F8, SRT, "Topographical Modifier")	1	U		See 15.9 GE Ultrasound Sidedness and Vessel Location
	>	CONTAINS	INCLUDE	DTID (300) Measurement	1-n	U		\$Measurement = See 15.10 Vascular Base Measurement \$Derivation = DCID (3626) Measurement

								Type
--	--	--	--	--	--	--	--	------

15.6 GEU APPLICATIONS AND EXTENSIONS

Section Scope	Section Laterality	Anatomy	Anatomy Ratio	GEU Parameters	
DT (121070, DCM, "Findings")	EV (G-C171, SRT, "Laterality")			BASE MEASUREMENT CONCEPT NAME	
(T-40501, SRT, "Blood Vessel of Head")	(G-A101, SRT, "Left") for Left, (G-A100, SRT, "Right") for Right. or (G-A103, SRT, "Unilateral")	DCID 12105 Intracranial Cerebral Vessels or DCID 12106 Intracranial Cerebral Vessels (Unilateral)		Anatomy GEU parameter	Code and Description
				ICA	(T-45300, SRT, "Internal Carotid Artery")
				MCA	G (T-45600, SRT, "Middle Cerebral Artery")
				ACA	(T-45540, SRT, "Anterior Cerebral Artery")
				PCA	(T-45900, SRT, "Posterior Cerebral Artery")
				PComA	(T-45320, SRT, "Posterior Communicating Artery")
				AComA	(T-45530, SRT, "Anterior Communicating Artery")
				VERT	(T-45700, SRT, "Vertebral Artery")
				BA	(T-45800, SRT, "Basilar Artery")
				TABLE 15.6.1 TCD Study Folder Code Maps	

(T-45005, SRT, "Artery of neck)	(G-A101, SRT, "Left") for Left, or (G-A100, SRT, "Right") for Right.	DCID 12104 Extracranial Arteries	DCID 12123 Carotid Ratios	Anatomy GEU parameter	Code and Description
				VERT	(T-45700, SRT, "Vertebral Artery")
				CCA	(T-45100, SRT, "Common Carotid Artery")
				ICA	(T-45300, SRT, "Internal Carotid Artery")
				BULB	(T-45170, SRT, "Carotid Bulb")
				ECA	(T-45200, SRT, "External Carotid Artery")
				SUBC	(T-46100, SRT, "Subclavian Artery")
				BIF	(SRT, T-45160, "Carotid Bifurcation")
TABLE 15.6.2 CAROTID STUDY FOLDER CODE MAPS					

(T-47040, SRT, "Artery of Lower Extremity") or (G-A101, SRT, "Left") for Left, or (G-A100, SRT, "Right") for Right. or (G-A103, SRT, "Unilateral")	DCID 12109 Lower Extremity Arteries or DCID 12112 Abdominal Arteries (unilateral)	Anatomy GEU parameter	Code and Description
		ComIliac	(T-46710, SRT, "Common Iliac Artery")
		ExtIliac (EIA)	(T-46910, SRT, "External Iliac Artery")
		ComFemoral (CFA)	(T-47400, SRT, "Common Femoral Artery")
		SupFemoral (SFA)	(T-47403, SRT, "Superficial Femoral Artery")
		Popliteal (Pop A)	(T-47500, SRT, "Popliteal Artery")
		AntTibial (ATA)	(T-47700, SRT, "Anterior Tibial Artery")
		PostTibial (PTA)	T-47600, SRT, "Posterior Tibial Artery")
		Peroneal (Peron A)	(T-47630, SRT, "Peroneal Artery")
		DorsPedis (DPA)	(T-47741, SRT, "Dorsalis Pedis Artery")
		DeepFemoral (DFA)	(T-47440, SRT, "Profunda Femoris Artery")
		Profunda (Pro)	(T-47440, SRT, "Profunda Femoris Artery")
		Aorta	(T-4200, SRT, "Aorta")

TABLE 15.6.3 LEA STUDY FOLDER CODE MAPS

(T-49403, SRT, “Vein of Lower Extremity”)	(G-A101, SRT, “Left”) for Left, or (G-A100, SRT, “Right”) for Right. Or (G-A103, SRT, “Unilateral”)	DCID 12110 Lower Extremity of Veins or DCID 12114 Abdominal Veins (unilateral)	Anatomy GEU parameter	Code and Description
			Popliteal	(T-49640, SRT, “Popliteal Vein”)
			LSaphenous	(T-49550, SRT, “Lesser Saphenous Vein”)
			AntTibial	(T-49630, SRT, “Anterior Tibial Vein”)
			PostTibial	(T-49620, SRT, “Posterior Tibial Vein”)
			Peroneal	(T-49650, SRT, “Peroneal Vein”)
			Profunda	(T-49660, SRT, “Profunda Femoris Vein”)
			ExtIliac	(T-48930, SRT, “External Iliac Vein”)
			ComFemoral	(G-035B, SRT, “Common Femoral Vein”)
			ComIliac	(T-48920, SRT, “Common Iliac Vein”)
			Great saphenous	(T-49530, SRT, “Great Saphenous Vein”)
			Femoral	(G-035B, SRT, “Femoral Vein”)
			IVC	(T-48710, SRT, “Inferior Vena Cava”)
			DeepFemoral	(T-49660, SRT, “Profunda Femoris Vein”)

TABLE 15.6.4 LEV STUDY FOLDER CODE MAPS

(T-47020, SRT, “Artery of Upper Extremity”)	(G-A101, SRT, “Left”) for Left, or (G-A100, SRT, “Right”) for Right.	DCID (12107) Upper Extremity Arteries		Anatomy GEU parameter	Code and Description
				SUBC	(T-46100, SRT, “Subclavian artery”)
				Axill	(T-47100, SRT, “Axillary artery”)
				BrachialA	(T-47160, SRT, “Brachial artery”)
				RadialA	(T-47300, SRT, “Radial artery”)
				UlnarA	(T-47200, SRT, “Ulnar artery”)
				Palmar	(T-47340, SRT, “Deep Palmar Arch of Radial Artery”)
				Innominate	(T-46010, SRT, “Innominate Artery”)
TABLE 15.6.5 UEA STUDY FOLDER CODE MAPS					

(T-49103, SRT, "Vein of Upper Extremity")	(G-A101, SRT, "Left") for Left, or (G-A100, SRT, "Right") for Right.	DCID 12108 Upper Extremity Veins		Anatomy GEU parameter	Code and Description
				JugularV	(T-48170, SRT, "Internal Jugular vein")
				InnoV	(T-48620, SRT, "Innominate vein")
				SUBCV	(T-48330, SRT, "Subclavian vein")
				AxillV	(T-49110, SRT, "Axillary vein")
				CephV	(T-49240, SRT, "Cephalic vein")
				BasilV	(T-48052, SRT, "Basilic vein")
				BracV	(T-49350, SRT, "Brachial vein")
				McubV	(T-49250, SRT, "Median Cubital vein")
				RadialV	(T-49340, SRT, "Radial vein")
				UlnarV	(T-49330, SRT, "Ulnar vein")
				TABLE 15.6.6 UEV STUDY FOLDER CODE MAPS	

(T-71019, SRT, "Vascular Structure of Kidney")	(G-A101, SRT, "Left") for Left, or (G-A100, SRT, "Right") for Right.	DCID 12115 Renal Vessels Or SRT T-71000 Kidney Or SRT T74000 Bladder	DCID 12124 Renal Ratios	Anatomy GEU parameter	Code and Description
				MRenalA	(T-46600, SRT, "Renal Artery")
				RenalV	(T-48740, SRT, "Renal Vein")
				SegmentalA	(T-46659, SRT, "Segmental Artery")
				InterlobarA	(T-4667D, SRT, "Interlobar Artery of Kidney")
				ArcurateA	(T-4668A, SRT, "Arcuate Artery of the Kidney")
				Aorta	(T-4200, SRT, "Aorta")
				RenalVolume	(G-D705, SRT, "Renal Volume")
				NewBladderDistL	(G-A22A, SRT, "Bladder Length")
				NewBladderDistH	(121207, DCM, "Bladder Height")
				NewBladderDistW	(G-A220, SRT, "Bladder Width")
				NewBladderVolume	(G-D705, SRT, "Bladder Volume")
				NewPostBladderDistL	(GEU-1004-32, GEU, "Post Void Bladder Length")
				NewPostBladderDistH	(GEU-1004-33, GEU, "Post Void Bladder Height")
				NewPostBladderDistW	(GEU-1004-34, GEU, "Post Void Bladder Width")
				NewPostBladderVolume	(GEU-1004-35, GEU, "Post Void Bladder Volume")
				CorticalThickness	(GEU-1007-13, GEU, "CorticalThickness")

TABLE 15.6.7. RENAL STUDY FOLDER CODE MAPS

(T-46002, SRT, "Artery of Abdomen")	(G-A101, SRT, "Left") for Left	DCID 12111 or 12112 Abdominal Arteries (lateral or unilateral).	Anatomy GEU parameter	Code and Description		
	(G-A100, SRT, "Right") for Right	DCID 12113 or 12114 Abdominal Veins (lateral or unilateral)			Aorta	(T-42000, SRT, "Aorta")
	or	or			Celiac	(T-46400, SRT, "Celiac Axis")
	(G-A103, SRT, "Unilateral")	DCID 12115 Renal Vessels			CHA	(T-46421, SRT, "Common Hepatic Artery")
	Or	Or			Splenic A	(T-46460, SRT, "Splenic Artery")
	(G-C0E3, SRT, "Finding")	SRT T-C3000 Spleen			SMA	(T-46510, SRT, "Superior Mesenteric Artery")
		Or			IMA	(T-46520, SRT, "Inferior Mesenteric Artery")
		SRT T-71000 Kidney			MRenalA	(T-46600, SRT, "Renal Artery")
					RenalV	(T-48740, SRT, "Renal Vein")
					SegmentalA	(T-46659, SRT, "Segmental Artery")
					InterlobarA	(T-4667D, SRT, "Interlobar Artery of Kidney")
					ArcurateA	(T-4668A, SRT, "Arcuate Artery of the Kidney")
					CIA	(T-46710, SRT, "Common Iliac Artery")
					PrHepatic	(T-46422, SRT, "Proper Hepatic Artery")
					GDA	(T-46440, SRT, Gastroduodenal Artery)
					IVC	(T-48710, SRT, "Inferior Vena Cava")
					Splenic V	(T-48890, SRT, Splenic Vein")
					Hepatic V	(T-48720, SRT, Hepatic Vein")
					MHV	(T-48726, SRT, Middle Hepatic Vein")
					MPV	(GEU-1004-65, 99GEMS, "Main Branch of Portal Vein")
		Portal V	(T-48810, SRT, "Portal Vein")			
		SMV	(T-48840, SRT, "Superior Mesenteric Vein")			
		TIPS	(G-036C, SRT, "Transjugular Intrahepatic Portosystemic Shunt")			
		CIV	(T-48920, SRT, "Common Iliac Vein")			

TABLE 15.6.8 ABDOMEN STUDY FOLDER CODE MAPS

(T-46002, SRT, "Artery of Abdomen") Continued				<table border="1"> <thead> <tr> <th data-bbox="950 436 1144 514">Anatomy GEU parameter</th> <th data-bbox="1144 436 1502 514">Code and Description</th> </tr> </thead> <tbody> <tr> <td data-bbox="950 514 1144 562">DiamRatioD1</td> <td data-bbox="1144 514 1502 562">(121206, DCM, "Distance")</td> </tr> <tr> <td data-bbox="950 562 1144 611">DiamRatioD2</td> <td data-bbox="1144 562 1502 611">(121206, DCM, "Distance")</td> </tr> <tr> <td data-bbox="950 611 1144 688">ABDiamRatio</td> <td data-bbox="1144 611 1502 688">(GEU-1004-55, 99GEMS, "A/B Diameter Ratio")</td> </tr> <tr> <td data-bbox="950 688 1144 737">AreaRatioA1</td> <td data-bbox="1144 688 1502 737">(121056, DCM, "Area Outline")</td> </tr> <tr> <td data-bbox="950 737 1144 814">AreaRatioA2</td> <td data-bbox="1144 737 1502 814">(121056, DCM, "Area Outline")</td> </tr> <tr> <td data-bbox="950 814 1144 892">ABAreaRatio</td> <td data-bbox="1144 814 1502 892">(GEU-1004-66, 99GEMS, "A/B Area Ratio")</td> </tr> <tr> <td data-bbox="950 892 1144 940">SplenicDistL</td> <td data-bbox="1144 892 1502 940">(G-A22A, SRT, "Splenic Length")</td> </tr> <tr> <td data-bbox="950 940 1144 989">SplenicDistH</td> <td data-bbox="1144 940 1502 989">(121207, DCM, "Splenic Height")</td> </tr> <tr> <td data-bbox="950 989 1144 1037">SplenicDistW</td> <td data-bbox="1144 989 1502 1037">(G-A220, SRT, "Splenic Width")</td> </tr> <tr> <td data-bbox="950 1037 1144 1085">SplenicVolume</td> <td data-bbox="1144 1037 1502 1085">(G-D705, SRT, "Splenic Volume")</td> </tr> <tr> <td data-bbox="950 1085 1144 1163">RenalVolumeD1</td> <td data-bbox="1144 1085 1502 1163">(GEU-1004-52, 99GEMS, "Volume Diameter 1")</td> </tr> <tr> <td data-bbox="950 1163 1144 1241">RenalVolumeD2</td> <td data-bbox="1144 1163 1502 1241">(GEU-1004-53, 99GEMS, "Volume Diameter 2")</td> </tr> <tr> <td data-bbox="950 1241 1144 1318">RenalVolumeD3</td> <td data-bbox="1144 1241 1502 1318">(GEU-1004-54, 99GEMS, "Volume Diameter 3")</td> </tr> <tr> <td data-bbox="950 1318 1144 1360">RenalManVolume</td> <td data-bbox="1144 1318 1502 1360">(G-D705, SRT, "Volume")</td> </tr> </tbody> </table> <p data-bbox="971 1371 1485 1430">TABLE 15.6.8 Abdomen Study Folder Code Maps (continued)</p>	Anatomy GEU parameter	Code and Description	DiamRatioD1	(121206, DCM, "Distance")	DiamRatioD2	(121206, DCM, "Distance")	ABDiamRatio	(GEU-1004-55, 99GEMS, "A/B Diameter Ratio")	AreaRatioA1	(121056, DCM, "Area Outline")	AreaRatioA2	(121056, DCM, "Area Outline")	ABAreaRatio	(GEU-1004-66, 99GEMS, "A/B Area Ratio")	SplenicDistL	(G-A22A, SRT, "Splenic Length")	SplenicDistH	(121207, DCM, "Splenic Height")	SplenicDistW	(G-A220, SRT, "Splenic Width")	SplenicVolume	(G-D705, SRT, "Splenic Volume")	RenalVolumeD1	(GEU-1004-52, 99GEMS, "Volume Diameter 1")	RenalVolumeD2	(GEU-1004-53, 99GEMS, "Volume Diameter 2")	RenalVolumeD3	(GEU-1004-54, 99GEMS, "Volume Diameter 3")	RenalManVolume	(G-D705, SRT, "Volume")
	Anatomy GEU parameter	Code and Description																																
	DiamRatioD1	(121206, DCM, "Distance")																																
	DiamRatioD2	(121206, DCM, "Distance")																																
	ABDiamRatio	(GEU-1004-55, 99GEMS, "A/B Diameter Ratio")																																
	AreaRatioA1	(121056, DCM, "Area Outline")																																
	AreaRatioA2	(121056, DCM, "Area Outline")																																
	ABAreaRatio	(GEU-1004-66, 99GEMS, "A/B Area Ratio")																																
	SplenicDistL	(G-A22A, SRT, "Splenic Length")																																
	SplenicDistH	(121207, DCM, "Splenic Height")																																
	SplenicDistW	(G-A220, SRT, "Splenic Width")																																
	SplenicVolume	(G-D705, SRT, "Splenic Volume")																																
	RenalVolumeD1	(GEU-1004-52, 99GEMS, "Volume Diameter 1")																																
	RenalVolumeD2	(GEU-1004-53, 99GEMS, "Volume Diameter 2")																																
	RenalVolumeD3	(GEU-1004-54, 99GEMS, "Volume Diameter 3")																																
RenalManVolume	(G-D705, SRT, "Volume")																																	

15.7 TID 300 MEASUREMENT

	NL	Relation with Parent	Value Type	Concept Name	VM	Req Type	Condition	Value Set Constraint
1			NUM	\$Measurement	1	M		Units = \$Units
4	>	HAS CONCEPT MOD	CODE	EV(G-A1F8, SRT, "Topographical modifier")	1	U		See 15.9 GE Ultrasound Sidedness and Vessel Location
5	>	HAS CONCEPT MOD	CODE	EV(121401, DCM, "Derivation")	1	U		See 15.11 Derivation and Selection
6	>	HAS PROPERTIES	CODE	EV(121404, DCM, "Selection Status")	1	U		See 15.11 Derivation and Selection

15.8 GE ULTRASOUND MODES

GE Ultrasound Modes	Code Value
2D	(G-03A2, SRT, "2D mode")
CF	(R-409E2, SRT, "Doppler Color Flow")
PW	(R-409E4, SRT, "Doppler Pulsed")
MM	(G-0394, SRT, "M mode")
CW	(R-409E3, SRT, "Doppler Continuous Wave")

15.9 GE ULTRASOUND SIDEDNESS AND VESSEL LOCATION

Side	Code Value
Rt	(G-A100, SRT, "Right")
Lt	(G-A101, SRT, "Left")

Vessel Location	Code Value
Prox	(G-A118, SRT, "Proximal")

Mid	(G-A188, SRT, "Mid-longitudinal")
Dist	(G-A119, SRT, "Distal")

Note (*) when there is no Sidedness or Locations, the SR nodes are not populated.

15.10 SR MAPPING TABLE FOR VASCULAR BASE MEASUREMENT CONCEPT

GEU Measurement Parameter	Standard Measurement Concept Name
PS	(11726-7, LN, "Peak Systolic Velocity")
ED	(11653-3, LN, "End Diastolic Velocity")
MD	(11665-7, LN, "Minimum Diastolic Velocity")
Tamax	(11692-1, LN, "Time averaged peak velocity")
PI	(12008-9, LN, "Pulsatility Index")
RI	(12023-8, LN, "Resistivity Index")
PV	(11726-7, LN, Peak Velocity)
SD Ratio	(12144-2, LN, "Systolic to Diastolic Velocity Ratio")
DS Ratio	(122218, DCM, Diastolic/Systolic velocity ratio)
Accel	(20167-3, LN, "Acceleration Index")
AT	(20168-1, LN, "Acceleration Time")
TAMEAN	(20352-1, LN, "Time averaged mean velocity")
VOLFLOW	(33878-0, LN, "Volume flow")
ICACCA Ratio (PS)	(33868-1, LN, "ICA/CCA velocity ratio")
HR (Heart Rate)	(8867-4, LN, Heart Rate)
AC	(GEU-1004-9, 99GEMS, "Angular Correction")
RAR	(33869-9, LN, "Renal Artery/Aorta velocity ratio")

TABLE 15.10.1 PWD-MODE MEASUREMENTS

GEU Measurement Parameter	Standard Measurement Concept Name
DiamStenD1/D2	(G-0364 , SRT, " Vessel Lumen Diameter")
AreaStenA1/A2	(G-0366, SRT, "Vessel Lumen Cross-Sectional Area")
StenosisD	(R-101BB, SRT, " Lumen Diameter Stenosis")
StenosisA	(R-101BA, SRT, "Lumen Area Stenosis")
IMT Ant Avg	(GEU-1005-20, 99GEMS, "IMT Anterior Average")
IMT Ant Max	(GEU-1005-21, 99GEMS, "IMT Anterior Max")
IMT Ant Min	(GEU-1005-22, 99GEMS, "IMT Anterior Min")
IMT Ant SD	(GEU-1005-23, 99GEMS, "IMT Anterior SD")
IMT Ant nMeas	(GEU-1005-24, 99GEMS, "IMT Anterior nMeas")
IMT Post Avg	(GEU-1005-26, 99GEMS, "IMT Posterior Average")
IMT Post Max	(GEU-1005-27, 99GEMS, "IMT Posterior Max")
IMT Post Min	(GEU-1005-28, 99GEMS, "IMT Posterior Min")
IMT Post SD	(GEU-1005-29, 99GEMS, "IMT Posterior SD")
IMT Post nMeas	(GEU-1005-30, 99GEMS, "IMT Posterior nMeas")
Aorta AP	(Diameter, SRT, M-02550), with Measurement Label ("Anterior-Posterior", DCM 122675)
Aorta Trans	(Diameter, SRT, M-02550), with Measurement Label ("Transverse", SRT, G-A117)
ILA AP	(Diameter, SRT, M-02550) with Measurement Label ("Anterior-Posterior", DCM, 122675)
ILA Trans	(Diameter, SRT, M-02440), with Measurement Label ("Transverse", SRT, G-A117)
DiamRatioD1, DiamRatioD2	(121206, DCM, "Distance")
ABDiamRatio	(GEU-1004-55, 99GEMS, "A/B Diameter Ratio")

AreaRatioA1, AreaRatioA2	(121056, DCM, "Area Outline")
ABAreaRatio	(GEU-1004-66, 99GEMS, "A/B Area Ratio")
ComIliac AP	(M-02550, SRT, "Common Iliac Artery Diameter") With Measurement Label (122675, DCM, "Anterior-Posterior") Inside (T-46710, SRT, "Common Iliac Artery")
ComIliacTrans	(M-02550, SRT, "Common Iliac Artery Diameter") With Measurement Label (G-A117, SRT, "Transverse") Inside (T-46710, SRT, "Common Iliac Artery")
ComIliac DiamStenD1/D2	(G-0364, SRT, "Vessel Lumen Diameter") Inside (T-46710, SRT, "Common Iliac Artery")
ComIliac StenosisD	(R-101BB, SRT, "Lumen Diameter Stenosis") Inside (T-46710, SRT, "Common Iliac Artery")
ComIliac AreaStenA1/A2	(G-0366, SRT, "Vessel Lumen Cross-Sectional Area") Inside (T-46710, SRT, "Common Iliac Artery")
ComIliac StenosisA	(R-101BA, SRT, "Lumen Area Stenosis") Inside (T-46710, SRT, "Common Iliac Artery")
ExtIliac AP	(M-02550, SRT, "External Iliac Artery Diameter") with Measurement Label (122675, DCM, "Anterior-Posterior") Inside (T-46910, SRT, "External Iliac Artery")
ExtIliac Trans	(M-02550, SRT, "External Iliac Artery Diameter") with Measurement Label (G-A117, SRT, "Transverse") Inside (T-46910, SRT, "External Iliac Artery")
ExtIliac DiamStenD1/D2	(G-0364, SRT, "Vessel Lumen Diameter") Inside (T-46910, SRT, "External Iliac Artery")
ExtIliac StenosisD	(R-101BB, SRT, "Lumen Diameter Stenosis") Inside (T-46910, SRT, "External Iliac Artery")
ExtIliac AreaStenA1/A2	(G-0366, SRT, "Vessel Lumen Cross-Sectional Area")

	Inside (T-46910, SRT, "External Iliac Artery")
ExtIliac StenosisA	(R-101BA, SRT, "Lumen Area Stenosis") Inside (T-46910, SRT, "External Iliac Artery")
ComFemoral AP	(M-02550, SRT, "Common Femoral Artery Diameter") with Measurement Label (122675, SRT, "Anterior-Posterior") Inside (T-47400, SRT, "Common Femoral Artery")
ComFemoral Trans	(M-02550, SRT, "Common Femoral Artery Diameter") with Measurement Label (G-A117, SRT, "Transverse") Inside (T-47400, SRT, "Common Femoral Artery")
ComFemoral Diam StenD1/D2	(G-0364, SRT, "Vessel Lumen Diameter") Inside (T-47400, SRT, "Common Femoral Artery")
ComFemoral StenosisD	(R-101BB, SRT, "Lumen Diameter Stenosis") Inside (T-47400, SRT, "Common Femoral Artery")
ComFemoral AreaStenA1/A2	(G-0366, SRT, "Vessel Lumen Cross-Sectional Area") Inside (T-47400, SRT, "Common Femoral Artery")
ComFemoral StenosisA	(R-101BA, SRT, "Lumen Area Stenosis") Inside (T-47400, SRT, "Common Femoral Artery")
2D AP	(M-02550, SRT, "Aorta") with Measurement Label (122675, SRT, "Anterior-Posterior") inside (T-42000, SRT, Aorta)
2D Trans	(M-02550, SRT, "Aorta") with Measurement Label (G-A117, SRT, "Transverse") inside (T-42000, SRT, Aorta)

TABLE 15.10.2 VASCULAR B-MODE MEASUREMENTS

GEU Measurement Parameter	Standard Measurement Concept Name
LiverDistL	(G-A22A, SRT, "Liver Length") Inside (T-62002, SRT, Liver) container

LiverDistH	(121207, DCM, "Liver Height") Inside (T-62002, SRT, Liver) container
LiverDistW	(G-A220, SRT, "Liver Width") Inside (T-62002, SRT, Liver) container
LiverVolume	(G-D705, SRT, "Liver Volume") Inside (T-62002, SRT, Liver) container
MassDistL	(G-A22A, SRT, "Mass Length") Inside (M-03000, SRT, Mass) container
MassDistH	(121207, DCM, "Mass Height") Inside (M-03000, SRT, Mass) container
MassDistW	(G-A220, SRT, "Mass Width") Inside (M-03000, SRT, Mass) container
MassVolume	(G-D705, SRT, "Mass Volume") Inside (M-03000, SRT, Mass) container
CystDistL	(G-A22A, SRT, "Cyst Length") Inside (M-3340A, SRT, Cyst) container
CystDistH	(121207, DCM, "Cyst Height") Inside (M-3340A, SRT, Cyst) container
CystDiswW	(G-A220, SRT, "Cyst Width") Inside (M-3340A, SRT, Cyst) container
CystDistVolume	(G-A220, SRT, "Cyst Volume") Inside (M-3340A, SRT, Cyst) container
PancHead	(GEU-1004-59, GEU, "Pancreas Head Diameter") Inside (T-D4034, SRT, Pancreas) container
PancDuct	(GEU-1004-61, GEU, "Pancreas Duct Diameter") Inside (T-D4034, SRT, Pancreas) container

PancBody	(GEU-1004-60, GEU, "Pancreas Body Diameter") Inside (T-D4034, SRT, Pancreas) container
CBDporta	(GEU-1004-67, GEU, "Common bile duct porta") Inside (T-60610, SRT, Bile Duct) container
CBDpanc	(GEU-1004-68, GEU, "Common bile duct pancreas") Inside (T-60610, SRT, Bile Duct) container
GBW	(GEU-1004-38, GEU, "Thickness of Gall Bladder Wall") Inside (T-63000, SRT, Gall Bladder) container
GBL	(G-A22A, SRT, "Gall Bladder Length") Inside (T-63000, SRT, Gall Bladder) container
AoProxAP	(M-02550, SRT, "Aorta Diameter") with (122675, DCM, "Anterior-Posterior") inside (T-42000, SRT, Aorta) with (Proximal, SRT,G-A118) as Topographical Modifier
AoProxTrans	(M-02550, SRT, "Aorta Diameter") with (G-A117, SRT, "Transverse") inside (T-42000, SRT, Aorta) with (Proximal, SRT,G-A118) as Topographical Modifier
AoMidAP	(M-02550, SRT, "Aorta Diameter") with (122675, DCM, "Anterior-Posterior") inside (T-42000, SRT, Aorta) with (Mid-longitudinal, SRT,G-A188) as Topographical Modifier
AoMidTrans	(M-02550, SRT, "Aorta Diameter") with (122675, DCM, "Anterior-Posterior") inside (T-42000, SRT, Aorta) with (Mid-longitudinal, SRT,G-A188) as Topographical Modifier
AoDistAP	(M-02550, SRT, "Aorta Diameter") with (122675, DCM, "Anterior-Posterior") inside (T-42000, SRT, Aorta) with (Distal, SRT,G-A119) as Topographical Modifier
AoDistTrans	(M-02550, SRT, "Aorta Diameter") with (G-A117, SRT, "Transverse") inside (T-42000, SRT, Aorta) with (Distal, SRT,G-A119) as Topographical Modifier

IliacAP	(M-02550, SRT, "Iliac artery Diameter") with Measurement Label (122675, DCM, "Anterior-Posterior") inside (T-46710, SRT, Common Iliac Artery)
IliacTrans	(M-02550, SRT, "Iliac artery Diameter") with Measurement Label (G-A117, SRT, "Transverse") inside (T-46710, SRT, Common Iliac Artery)
BladderDistL	(G-A22A, SRT, "Bladder Length") Inside (T-74000, SRT, Bladder) container
BladderDistH	(121207, DCM, "Bladder Height") Inside (T-74000, SRT, Bladder) container
BladderDistW	(G-A220, SRT, "Bladder Width") Inside (T-74000, SRT, Bladder) container
BladderVolume	(G-D705, SRT, "Bladder Volume") Inside (T-74000, SRT, Bladder) container
CeliacA AP	(M-02550, SRT, "Celiac Axis Diameter") with Measurement Label (122675, DCM, "Anterior-Posterior") inside (T-46400, SRT, Celiac Axis)
CeliacA Trans	(M-02550, SRT, "Celiac Axis Diameter") with Measurement Label (G-A117, SRT, "Transverse") inside (T-46400, SRT, Celiac Axis)
CeliacA DiamStenD1/D2	(G-0364, SRT, "Vessel Lumen Diameter") inside (T-46400, SRT, Celiac Axis)
CeliacA Stenosis D	(R-101BB, SRT, "Lumen Diameter Stenosis") inside (T-46400, SRT, Celiac Axis)
CeliacA AreaStenA1/A2	(G-0366, SRT, "Vessel Lumen Cross-Section Area") inside (T-46400, SRT, Celiac Axis)
CeliacA StenosisA	(R-101BA, SRT, "Lumen Area Stenosis") inside (T-46400, SRT, Celiac Axis)

CeliacA SMA AP	(R-101BA, SRT, "Lumen Area Stenosis") inside (T-46400, SRT, Celiac Axis)
SMA AP	(M-02550, SRT, "Superior Mesenteric Artery Diameter") with Measurement Label (122675, DCM, "Anterior-Posterior") inside (T-46510, SRT, Superior Mesenteric Artery)
SMA Trans	(M-02550, SRT, "Superior Mesenteric Artery Diameter") with Measurement Label (G-A117, SRT, "Transverse") inside (T-46510, SRT, Superior Mesenteric Artery)
SMA DiamStenD1/D2	(G-0364, SRT, "Vessel Lumen Diameter") inside (T-46510, SRT, Superior Mesenteric Artery)
SMA StenosisD	(R-101BB, SRT, "Lumen Diameter Stenosis") inside (T-46510, SRT, Superior Mesenteric Artery)
SMA AreaStenA1/A2	(G-0366, SRT, "Vessel Lumen Cross-Section Area") inside (T-46510, SRT, Superior Mesenteric Artery)
SMA StenosisA	(R-101BA, SRT, "Lumen Area Stenosis") inside (T-46510, SRT, Superior Mesenteric Artery)
IMA AP	(M-02550, SRT, "Inferior Mesenteric Artery Diameter") with Measurement Label (122675, DCM, "Anterior-Posterior") inside (T-46520, SRT, Inferior Mesenteric Artery)
IMA Trans	(M-02550, SRT, "Inferior Mesenteric Artery Diameter") with Measurement Label (G-A117, SRT, "Transverse") inside (T-46520, SRT, Inferior Mesenteric Artery)
IMA DiamStenD1/D2	(G-0364, SRT, "Vessel Lumen Diameter") inside (T-46520, SRT, Inferior Mesenteric Artery)
IMA StenosisD	(R-101BB, SRT, "Lumen Diameter Stenosis") inside (T-46520, SRT, Inferior Mesenteric Artery)
IMA AreaStenA1/A2	(G-0366, SRT, "Vessel Lumen Cross-Section Area") inside (T-46520, SRT, Inferior Mesenteric Artery)

IMA StenosisA	(R-101BA, SRT, "Lumen Area Stenosis") inside (T-46520, SRT, Inferior Mesenteric Artery)
Stent AP	(M-02550, SRT, "Vessel Diameter") with Measurement Label (122675, DCM, "Anterior-Posterior") inside (A-25500, SRT, Stent)
Stent Trans	(M-02550, SRT, "Vessel Diameter") with Measurement Label (G-A117, SRT, "Transverse") inside (A-25500, SRT, Stent)
Stent DiamStenD1/D2	(G-0364, SRT, "Vessel Lumen Diameter") inside (A-25500, SRT, Stent)
Stent StenosisD	(R-101BB, SRT, "Lumen Diameter Stenosis") inside (A-25500, SRT, Stent)
Stent AreaStenA1/A2	(G-0366, SRT, "Vessel Lumen Cross-Section Area") inside (A-25500, SRT, Stent)
Stent StenosisA	(R-101BA, SRT, "Lumen Area Stenosis") inside (A-25500, SRT, Stent)
PreStent AP	(M-02550, SRT, "Vessel Diameter") with Measurement Label (122675, DCM, "Anterior-Posterior") inside (GEU-1004-71, GEU, Pre-Stent)
PreStent Trans	(M-02550, SRT, "Stent") with Measurement Label (G-A117, SRT, "Transverse") inside (GEU-1004-71, GEU, Pre-Stent)
PreStent DiamStenD1/D2	(G-0364, SRT, "Vessel Lumen Diameter") inside (GEU-1004-71, GEU, Pre-Stent)
PreStent StenosisD	(R-101BB, SRT, "Lumen Diameter Stenosis") inside (GEU-1004-71, GEU, Pre-Stent)
PreStent AreaStenA1/A2	(G-0366, SRT, "Vessel Lumen Cross-Section Area") inside (GEU-1004-71, GEU, Pre-Stent)

PreStent StenosisA	(R-101BA, SRT, "Lumen Area Stenosis") inside (GEU-1004-71, GEU, Pre-Stent)
PostStent AP	(M-02550, SRT, "Vessel Diameter") with Measurement Label (122675, DCM, "Anterior-Posterior") inside (GEU-1004-72, GEU, Post-Stent)
PostStent Trans	(M-02550, SRT, "Stent") with Measurement Label (G-A117, SRT, "Transverse") inside (GEU-1004-72, GEU, Post-Stent)
PostStent DiamStenD1/D2	(G-0364, SRT, "Vessel Lumen Diameter") inside (GEU-1004-72, GEU, Post-Stent)
PostStent StenosisD	(R-101BB, SRT, "Lumen Diameter Stenosis") inside (GEU-1004-72, GEU, Post-Stent)
PostStent AreaStenA1/A2	(G-0366, SRT, "Vessel Lumen Cross-Section Area") inside (GEU-1004-72, GEU, Post-Stent)
PostStent StenosisA	(R-101BA, SRT, "Lumen Area Stenosis") inside (GEU-1004-72, GEU, Post-Stent)
AortaAP	(M-02550, SRT, "Aorta Diameter") with Measurement Label (122675, DCM, "Anterior-Posterior") inside (T-42000, SRT, Aorta)
AortaTrans	(M-02550, SRT, "Aorta Diameter") with Measurement Label (G-A117, SRT, "Transverse") inside (T-42000, SRT, Aorta)
Aorta Sagittal	(M-02550, SRT, "Aorta Diameter") with Measurement Label (G-A117, SRT, "Sagittal") inside (T-42000, SRT, Aorta)
IIA DiamStenD1/D2	(G-0364, SRT, "Vessel Lumen Diameter") inside (T-46740, SRT, Internal Iliac Artery)
IIA StenosisD	(R-101BB, SRT, "Lumen Diameter Stenosis")

	inside (T-46740, SRT, Internal Iliac Artery)
IIA AreaStenA1/A2	(G-0366, SRT, "Vessel Lumen Cross-Section Area") inside (T-46740, SRT, Internal Iliac Artery)
IIA StenosisA	(R-101BA, SRT, "Lumen Area Stenosis") inside (T-46740, SRT, Internal Iliac Artery)
SpleenDistL	(G-A22A, SRT, Spleen Length) Inside (T-C3000, SRT, Spleen)
SpleenDistH	(121207, DCM, Spleen Height) Inside (T-C3000, SRT, Spleen)
SpleenDistW	(G-A220, SRT, Spleen Width) Inside (T-C3000, SRT, Spleen)
SpleenVolume	(G-D705, SRT, Spleen Volume) Inside (T-C3000, SRT, Spleen)
Aorta DiamStenD1/D2	(G-0364, SRT, "Vessel Lumen Diameter") inside (T-42000, SRT, Aorta)
Aorta StenosisD	(R-101BB, SRT, "Lumen Diameter Stenosis") inside (T-42000, SRT, Aorta)
AortaStenA1/A2	(G-0366, SRT, "Vessel Lumen Cross-Section Area") inside (T-42000, SRT, Aorta)
Aorta StenosisA	(R-101BA, SRT, "Lumen Area Stenosis") inside (T-42000, SRT, Aorta)

TABLE 15.10.3 ABDOMEN B-MODE MEASUREMENTS

15.11 DERIVATION AND SELECTION

GEU Name	Derivation	Selection
Av	Mean	User chosen value

Mx	Maximum	User chosen value
Mn	Minimum	User chosen value
Lt	Most recent value chosen	User chosen value
* (decided by another parameter)	Best Value	User chosen value

16. DICOM STRUCTURE REPORTS – USER DEFINED OBJECTS

The Vivid Ultrasound Scanner provides the operator the ability to define measurements and export them in a manner compliant with established DICOM templates. This functionality is defined explicitly within the user manual for the Vivid scanner. Please consult the User Manual for more details and how to use this functionality.

16.1 GE DEFAULT DICOM EXPORT FORMAT

The GE Vivid Ultrasound Scanner allows the user to define measurements without specifying codes or meanings for the measurements. This default value is used when creating a user defined measurement within the Measurement menu. The measurements defined in this manner use a common structure.

Example of a user defined measurement format:

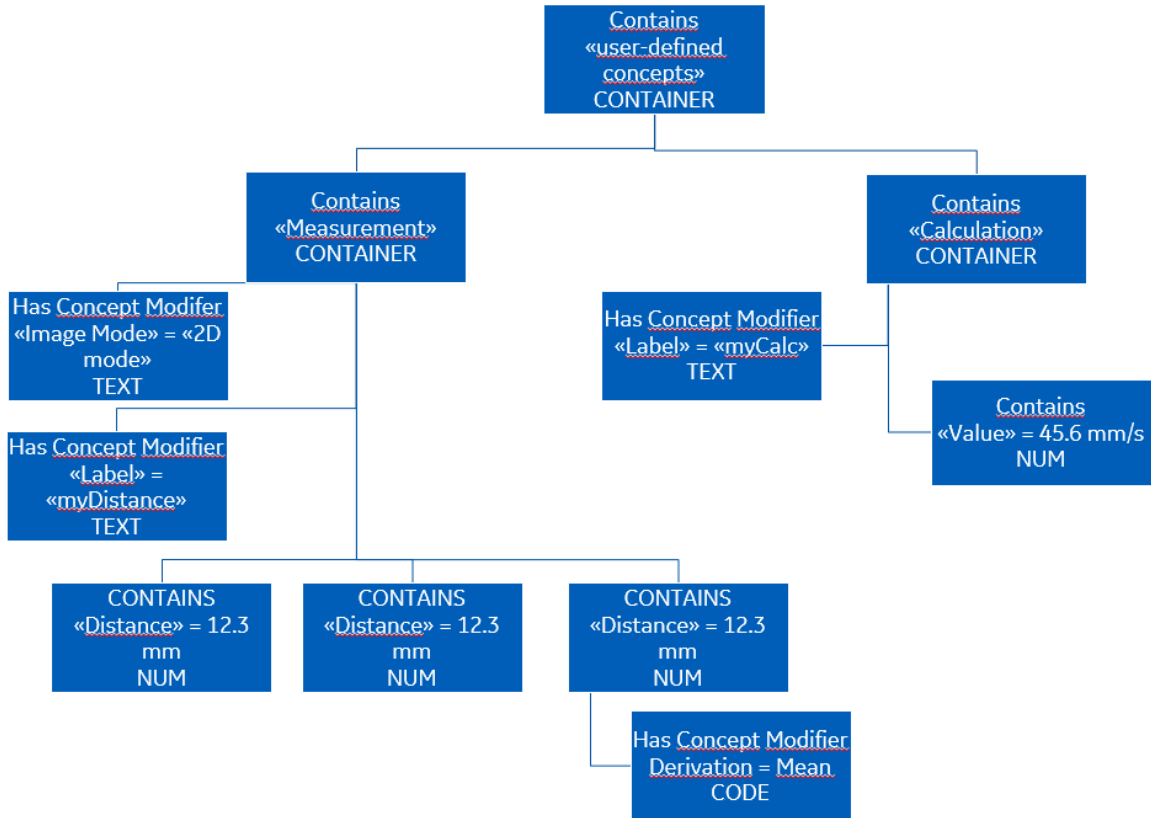

16.2 TEMPLATE EXTENSIONS

16.2.1 TID5100: Vascular Ultrasound Report Extensions

	NL	Rel with Parent	VT	Concept Name	VM	Reg Type	Condition	Value Set Constraint
...
12	>	CONTAINS	INCLUDES	TID(9900) User-defined concepts	1	U		

16.2.2 TID5200: Adult Echo Template Report Extensions

	NL	Rel with Parent	VT	Concept Name	VM	Reg Type	Condition	Value Set Constraint
...
31	>	CONTAINS	INCLUDES	TID(9900) User-defined concepts	1	U		

16.2.3 TID5220: Pediatric Template Report Extensions

	NL	Rel with Parent	VT	Concept Name	VM	Reg Type	Condition	Value Set Constraint
...
31	>	CONTAINS	INCLUDES	TID(9900) User-defined concepts	1	U		

16.2.4 TID9900: User-defined concepts

	NL	Rel with Parent	VT	Concept Name	VM	Reg Type	Condition	Value Set Constraint
--	----	-----------------	----	--------------	----	----------	-----------	----------------------

1			CONTAINER	DT(T9900-01, 99GEMS, "User-defined ceopts")	1	M		
2	>	CONTAINS	INCLUDE	TID(9901) User-defined concept	1-n	MC	One of row 2 and 3 must be present	\$Type = DT (T9900-02, 99GEMS, "Measurement")
3	>	CONTAINS	INCLUDE	TID(9901) User-defined concept	1-n	MC	One of row 2 and 3 must be present	\$Type = DT (T9900-03, 99GEMS, "Calculation")

16.2.5 TID9901: User-defined concept

	NL	Rel with Parent	VT	Concept Name	VM	Reg Type	Condition	Value Set Constraint
1			CONTAINER	\$Type	1	M		
2	>	HAS CONCEPT MOD	TEXT	DT(T9900-04,99GEMS, "Label")	1	M		
3	>	CONTAINS	INCLUDE	TID (300)	1	1-n	IFF \$Type = "Measurement"	\$Measurement = DCID (99008) Results \$Derivation - (3627) Measurement Type
4	>	CONTAINS	INCLUDE	TID (300)	1	1	IFF \$Type = "Calculation"	\$Measurement = DT(T9900-05, 99GEMS, "Value")
5	>	INFERRED FROM	TEXT	DCID(228)	1	U		

16.3 USER DEFINED DICOM MAPPINGS

The Vivid Ultrasound Scanner does allow for more specific DICOM mappings for user defined measurements.

Within the DICOM Mapping configuration Interface, the user will be presented with the Category and Parameter to map. The desired measurement must be chosen from these two fields to initiate the mapping process.

When defining the measurement in the Mappings Interface, the user is required to specify the following DICOM fields:

- Finding Site
- Coding Scheme Value
- Coding Scheme Designator
- Coding Scheme Meaning

There are other DICOM attributes available within the Mapping Interface which are optional to define. If defined, they may help describe the measurement more accurately. These include:

- View
- Phase
- Method
- Target
- Direction
- Respiratory Cycle Point

The values defined for the measurement will be presented to the user within a DICOM Encoding dialogue box within the DICOM Mapping configuration page. This visual representation shows the DICOM fields mapped when exporting the user defined object within the DICOM Structured Report.